



ACC600 Series

Convection Cooled Open Frame Power Supplies

The ACC600 Series of open frame power supplies feature a wide universal AC input range of 85 – 264 VAC, offering up to 600 W of output power with convection cooling (U-Channel), in a compact footprint, with a variety of single output voltages.

The high efficiency and high power density of the ACC series ensures minimal power loss in end-use equipment, thereby facilitating higher reliability, easier thermal management and meets regulatory approvals for environmentally-friendly end products.

These power supplies are ideal for medical, telecom, datacom, industrial equipment and other applications.



Key Features & Benefits

- 5 x 8.5 x 1.61 Inch Form Factor (127 x 216 x 41 mm)
- Convection Cooling Rated
- Universal Input
- Current Sharing Option
- Peak Power Capability
- 5 VDC Stand by
- 12 V fan output
- Power Good / Power Fail Signal
- Suitable in POE applications
- Lesser than 1U high
- Having high voltage output range up to 58 VDC
- N+1 redundant power supply
- Single wire current sharing
- Built in OR-ing diode / FET (- R suffix)

Applications

- Instrumentation
- Lighting
- Industrial Applications
- Applied Computing
- Renewable Energy
- Test and Measurement
- Robotics
- Wireless Communication



bel POWER SOLUTIONS & PROTECTION

a bel group

belfuse.com/power-solutions

1. MODEL SELECTION

| MODEL NUMBER* | VOLTAGE | TYPE | MAX. LOAD (CONVECTION) | MIN. LOAD | RIPPLE & NOISE |
|---------------|---------|-----------|------------------------|-----------|----------------|
| ACC600-1T12 | 12 V | U-Channel | 25 A | 0.0 A | 2% |
| ACC600-1T15 | 15 V | U-Channel | 25 A | 0.0 A | 2% |
| ACC600-1T24 | 24 V | U-Channel | 25 A | 0.0 A | 2% |
| ACC600-1T30 | 30 V | U-Channel | 20 A | 0.0 A | 2% |
| ACC600-1T48 | 48 V | U-Channel | 12.5 A | 0.0 A | 2% |
| ACC600-1T58 | 58 V | U-Channel | 10.34 A | 0.0 A | 2% |

* To order product without the redundancy diode option please add the suffix-Sxxx to your required part number. Please contact the factory for availability.

2. INPUT SPECIFICATIONS

Specifications are for nominal input voltage, 25°C unless otherwise stated.

| PARAMETER | DESCRIPTION / CONDITION | SPECIFICATION |
|---------------------|--|-----------------------------------|
| Input Voltage | Universal | 85 – 264 VAC / 120 – 390 VDC |
| Input Frequency | | 47 – 63 Hz |
| Input Current | 120 VAC: 240 VAC: | 6.5 A max. 3.2 A max. |
| Input Protection | In Live & Neutral both | F16 A / 250 V |
| No Load Power | Over entire input range with main output kept OFF using Remote ON/OFF | 3 W typ. |
| Inrush Current | 240 VAC: | 25 A max. |
| Leakage Current | 240 VAC / 50 Hz | 400 μ A |
| Touch Current: | | < 100 μ A |
| Power Factor | 120 VAC: 240 VAC: | 0.98 0.95 |
| Switching Frequency | PFC converter: Variable Resonant converter: Variable | 85 kHz typical 100 kHz typical |

3. OUTPUT SPECIFICATIONS

| PARAMETER | DESCRIPTION / CONDITION | SPECIFICATION |
|-----------------------------|--|--------------------------------|
| Output Power | Convection | 600 W |
| Efficiency | 120 VAC: 240 VAC: | 88% Typical 93% |
| Hold-up Time | 120 VAC / 240 VAC: | 8 ms |
| Line Regulation | | +/-0.5% |
| Load Regulation | | +/-1.0% |
| Transient Response | 50% to 100% load change, 50 Hz, 50% duty cycle, 0.1 A/ μ s | < 10%, recovery time < 5 ms |
| Voltage Adjustment | | +/-3% |
| Set Point Tolerance | | +/-1% |
| Rise Time | | <100 ms |
| Over Current Protection | Hic-Up Type, autorecovery | 110% |
| Over Voltage Protection | Latch Type, AC Power to be recycled for recovery | 114% |
| Short Circuit Protection | Latch Type, AC Power to be recycled for recovery | |
| Over Temperature Protection | Autorecovery | 130 - 140°C primary heat sink |
| Current Share | Up to 3 supplies connected in parallel (optional) | |

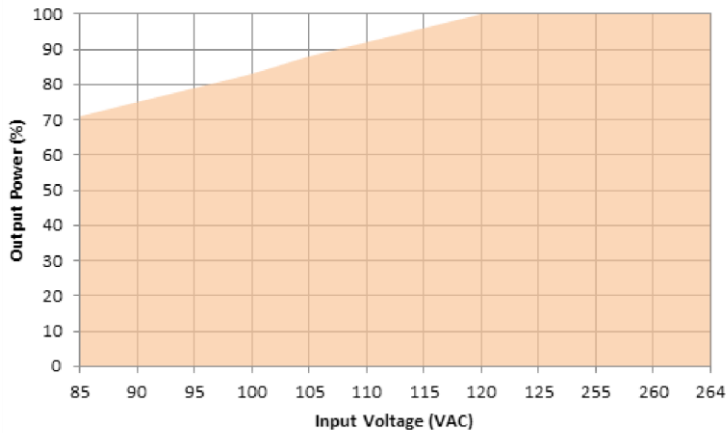
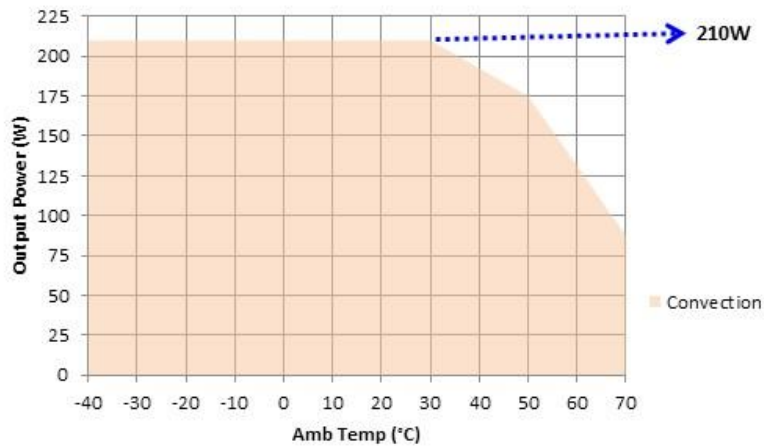
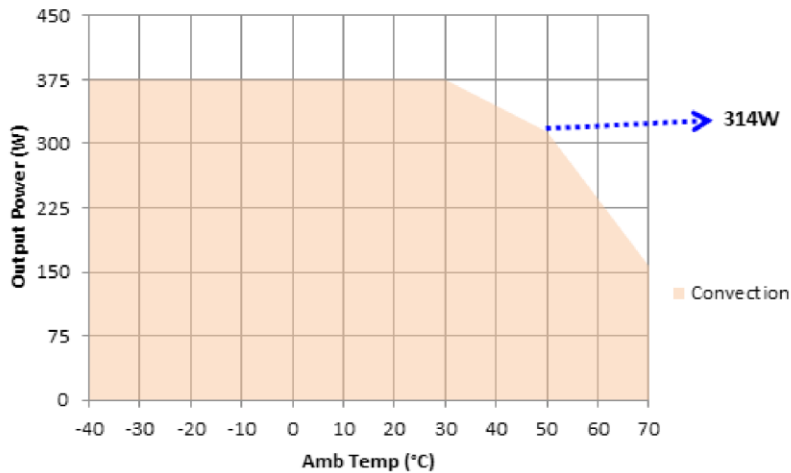

Figure 1. Power Derating w.r.t Input



Convection load: 300 W up to 30 °C
 De-rate between 30-50 °C @ 0.833% per °C
 De-rate above 50 °C @ 2.5% per °C

Figure 2. Power Derating Curve 12 V



Convection load: 375 W up to 30 °C
 De-rate between 30-50 °C @ 0.8133% per °C
 De-rate above 50 °C @ 2.5% per °C

Figure 3. Power Derating Curve 15 V

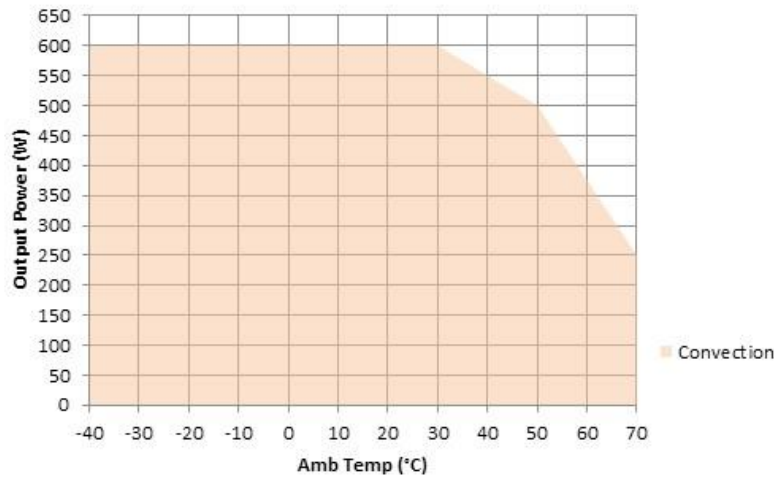

Convection load: 600 W up to 30 °C
 De-rate between 30-50 °C @ 0.833% per °C
 De-rate above 50 °C @ 2.5% per °C

Figure 4. Power Derating Curve 24 V and above

4. ENVIRONMENTAL SPECIFICATIONS

| PARAMETER | DESCRIPTION / CONDITION | SPECIFICATION |
|-----------------------|------------------------------|--------------------------|
| Operating Temperature | Refer to derating curve | -40 to +70°C |
| Storage Temperature | | -40 to +85°C |
| Relative Humidity | Non-condensing | 5% to 95% |
| Altitude | Operating: Non-operating: | 16,000 ft. 40,000 ft. |
| MTBF | Telcordia -SR332-issue 3 | 3.37 million hours |

5. EMC SPECIFICATIONS

| PARAMETER | DESCRIPTION / CONDITION | CRITERIA |
|------------------------------------|-------------------------|---|
| Conducted Emissions | EN55032 | Class B |
| Radiated Emissions | EN 55032 | Class A (Class B with External king core K5B RC 25x12x15-M or equivalent) |
| Input Current Harmonics | EN 61000-3-2 | Class A |
| Voltage Fluctuation and Flicker | EN 61000-3-3 | Pass |
| ESD Immunity | EN 61000-4-2 | A |
| Radiated Field Immunity | EN 61000-4-3 | A |
| Electrical Fast Transient Immunity | EN 61000-4-4 | A |
| Surge Immunity | EN 61000-4-5 | A |
| Conducted Immunity | EN 61000-4-6 | A |
| Magnetic Field Immunity | EN 61000-4-8 | A |
| Voltage Dips, Interruptions | EN 61000-4-11 | A & B |

6. SAFETY SPECIFICATIONS

| PARAMETER | DESCRIPTION / CONDITION | SPECIFICATION |
|--------------------|--|----------------------|
| Isolation Voltage | Input to Output Input to Earth | 4000 VDC 2500 VDC |
| Safety Standard(s) | IEC/EN 62368-1, ED 2 UL62368-1, CSA C22.2 No. 62368-1 | |
| Agency Approvals | Nemko, UL, C-UL | |
| CE mark | Complies with LVD Directive | |

NOTES:

1. For Ripple measurement minimum output power requirement is 25 W. Ripple is peak to peak with 20 MHz bandwidth and 10 μ F (Tantalum capacitor) in parallel with a 0.1 μ F capacitor at rated line voltage and load ranges. Please contact factory/ sales representative for minimum load required for ripple to be within specification.
2. Combined output power of main output, fan supply and standby supply shall not exceed max. power rating.
3. Standby output voltage 5 V / 1.5 A (convection) with tolerance including set point accuracy, line and load regulation is +/-10%. Ripple and noise is less than 5%.
4. Specifications are for nominal input voltage, 25°C unless otherwise stated.
5. PSU is supplied with J3, pin-6 and pin-7 shorted to enable main output without remote on/off feature.

7. SIGNALS

| PARAMETER | DESCRIPTION / CONDITION |
|--------------------------|--|
| Power Good / Fail Signal | Power Good: Is a TTL signal which goes high after main output reaches 90% of its set value. The delay is 0.1 s to 0.5 s Power Fail: The same signal goes low at least 1ms before main output falls to 90% of set value at AC Power off |
| Remote Sense | Compensates for 200 mV drop |
| Remote On / Off | Pin 6 & Pin 7 of J3 can be used for Remote on/off. Shorting Pin 6 to Pin 7 enables main output while keeping the pins open disables main output |
| OCP Limit Set | Pin 8 & Pin 9 of J3 must be left open |

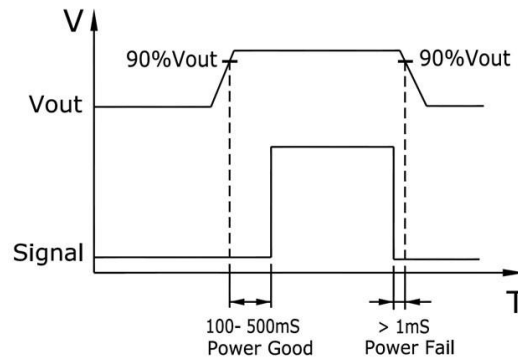

Figure 5. Power Good / Fail Signal Diagram

8. CONNECTOR & PIN DESCRIPTION

| CONNECTOR | PIN | DESCRIPTION / CONDITION | MANUFACTURER / PN |
|---------------------|-----------------|--|--|
| AC Input Connector | J1 | Pin 1 AC Line Pin 2 Neutral Pin 3 Earth | TE Connectivity: NC6-P107-03 |
| DC Output Connector | J2 | J2-A +VE J2-B -VE | 6-32 inches Screw Pan HD Mating: Designed to accept Ring Tongue Terminal AMP: 8-31886-1, wherein one 16 AWG (max) wire can be crimped. Note: One Ring Tongue Terminal with 16 AWG is recommended for current up to 11 A only. Use multiple tongue terminals with wire for more current. |
| Aux (Fan) Output | J3 ¹ | Pin 1 GND Pin 2 5V AUX Pin 3 PGPF Pin 4 VS - Pin 5 VS + Pin 6 GND Pin 7 RMT Pin 8 CL2 Pin 9 CL1 Pin 10 LS | Molex: 22-23-2101 Mating: 22-01-2107; Pins: 08-50-0113 |
| Fan Output | J10, J11 | Pin 1 +VE Pin 2 -VE | |

9. MECHANICAL SPECIFICATIONS

| PARAMETER | DESCRIPTION / CONDITION |
|------------|---|
| Weight | 1100 g |
| Dimensions | 127 x 216 x 41 mm (5.0 x 8.5 x 1.61 inches) |
| Cooling | Convection: 600 W (U-Channel) |

¹ PSU is supplied with J3, pin-6 and pin-7 shorted to enable main output without remote on/off feature.

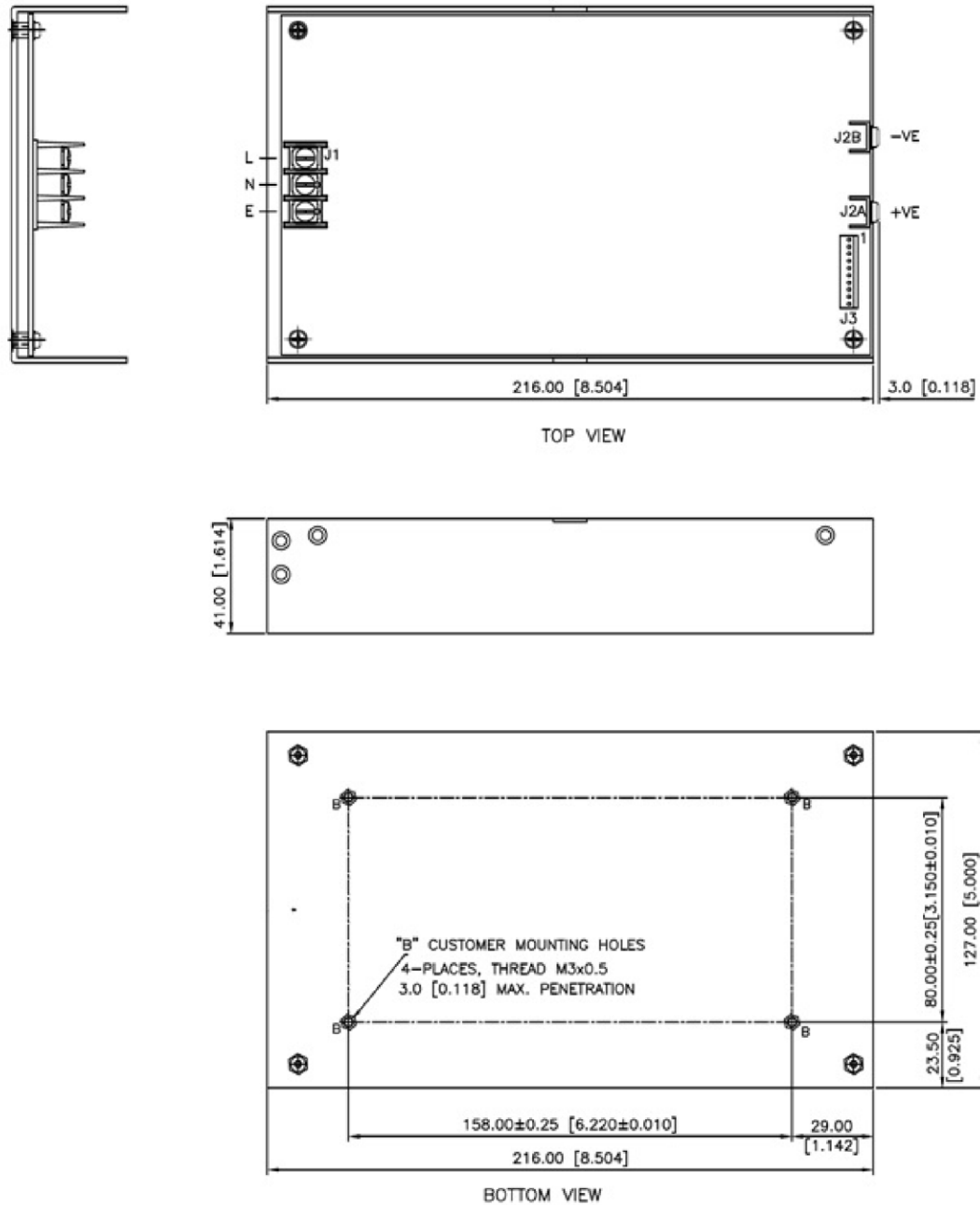

MECHANICAL OUTLINE DIMENSIONS
 ALL DIMENSIONS ARE IN MM [INCHES]
 GEN.TOLERANCE: ±1.0 MM [±0.04]

Figure 6. Mechanical drawings

10. INSTALLTION INSTRUCTION FOR CURRENT SHARING

During the installation and setup of parallel supplies in a system it is important that a single remote sense point be used for all the supplies. The remote sense voltage between the supplies must be adjusted to within 1% to ensure the supplies are inside the 1% capture window. If the supplies are not initially adjusted inside the capture window the supplies will not current share satisfactorily.

SET-UP PROCEDURE:

1. Connect load cables to the outputs of each supply.
2. Connect the remote sense lines to the load in twisted style. (A common remote sense point must be used for all the supplies in parallel).
3. Connect all the "LS" signal (Pin 10) on the J3 connector between the supplies.
4. Adjust remote sense voltage of each supply to within 1% of rated output voltage or readjust to required set point. (Adjustment to be done with all other parallel supplies off).
5. Current sharing between the supplies can be verified by monitoring the output current of each supply with a hall effect DC current probe. The supplies should share to within 10% of the total load current.
6. The current share circuit has a capture window voltage of +/- 1% of the rated output voltage. If the output remote sense voltage of one of the supplies is adjusted outside the 1% window the supplies will not current share satisfactorily.

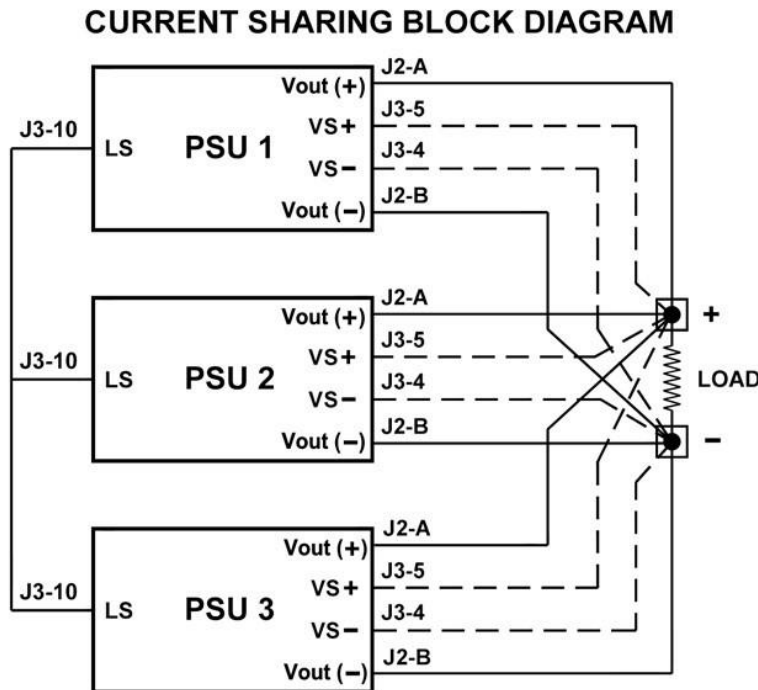

Figure 7. Current Sharing Block Diagram

For more information on these products consult: tech.support@psbel.com

NUCLEAR AND MEDICAL APPLICATIONS - Products are not designed or intended for use as critical components in life support systems, equipment used in hazardous environments, or nuclear control systems.

TECHNICAL REVISIONS - The appearance of products, including safety agency certifications pictured on labels, may change depending on the date manufactured. Specifications are subject to change without notice.

Компания «Life Electronics» занимается поставками электронных компонентов импортного и отечественного производства от производителей и со складов крупных дистрибьюторов Европы, Америки и Азии.

С конца 2013 года компания активно расширяет линейку поставок компонентов по направлению коаксиальный кабель, кварцевые генераторы и конденсаторы (керамические, пленочные, электролитические), за счёт заключения дистрибьюторских договоров

Мы предлагаем:

- Конкуренспособные цены и скидки постоянным клиентам.
- Специальные условия для постоянных клиентов.
- Подбор аналогов.
- Поставку компонентов в любых объемах, удовлетворяющих вашим потребностям.
- Приемлемые сроки поставки, возможна ускоренная поставка.
- Доставку товара в любую точку России и стран СНГ.
- Комплексную поставку.
- Работу по проектам и поставку образцов.
- Формирование склада под заказчика.
- Сертификаты соответствия на поставляемую продукцию (по желанию клиента).
- Тестирование поставляемой продукции.
- Поставку компонентов, требующих военную и космическую приемку.
- Входной контроль качества.
- Наличие сертификата ISO.

В составе нашей компании организован Конструкторский отдел, призванный помогать разработчикам, и инженерам.

Конструкторский отдел помогает осуществить:

- Регистрацию проекта у производителя компонентов.
- Техническую поддержку проекта.
- Защиту от снятия компонента с производства.
- Оценку стоимости проекта по компонентам.
- Изготовление тестовой платы монтаж и пусконаладочные работы.



Тел: +7 (812) 336 43 04 (многоканальный)
Email: org@lifeelectronics.ru