

FEATURES

High isolation voltage: 5000 V rms
Enhanced system-level ESD performance per IEC 61000-4-x
Low power operation

5 V operation

1.6 mA per channel maximum at 0 Mbps to 1 Mbps
 3.7 mA per channel maximum at 10 Mbps

3.3 V operation

1.4 mA per channel maximum at 0 Mbps to 1 Mbps
 2.4 mA per channel maximum at 10 Mbps

Bidirectional communication

3.3 V/5 V level translation

High temperature operation: 125°C

Default low output

High data rate: dc to 10 Mbps (NRZ)

Precise timing characteristics

3 ns maximum pulse width distortion

3 ns maximum channel-to-channel matching

High common-mode transient immunity: >25 kV/μs

16-lead SOIC wide body package version (RW-16)

16-lead SOIC wide body enhanced creepage version (RI-16)

Safety and regulatory approvals (RI-16 package)

UL recognition: 5000 V rms for 1 minute per UL 1577

CSA Component Acceptance Notice 5A

IEC 60601-1: 250 V rms (reinforced)

IEC 60950-1: 400 V rms (reinforced)

VDE Certificate of Conformity

DIN V VDE V 0884-10 (VDE V 0884-10):2006-12

V_{IORM} = 846 V peak

Qualified for automotive applications

APPLICATIONS

General-purpose, high voltage, multichannel isolation

Medical equipment

Power supplies

RS-232/RS-422/RS-485 transceiver isolation

Hybrid electric vehicles, battery monitors, and motor drives

GENERAL DESCRIPTION

The ADuM2210/ADuM2211¹ are 2-channel digital isolators based on Analog Devices, Inc., iCoupler® technology. Combining high speed CMOS and monolithic air core transformer technology, these isolation components provide outstanding performance characteristics that are superior to alternatives such as optocoupler devices.

By avoiding the use of LEDs and photodiodes, iCoupler devices remove the design difficulties commonly associated with optocouplers.

¹ Protected by U.S. Patents 5,952,849; 6,873,065; 6,903,578; and 7,075,329. Other patents pending.

Rev. F **Document Feedback**
 Information furnished by Analog Devices is believed to be accurate and reliable. However, no responsibility is assumed by Analog Devices for its use, nor for any infringements of patents or other rights of third parties that may result from its use. Specifications subject to change without notice. No license is granted by implication or otherwise under any patent or patent rights of Analog Devices. Trademarks and registered trademarks are the property of their respective owners.

FUNCTIONAL BLOCK DIAGRAMS

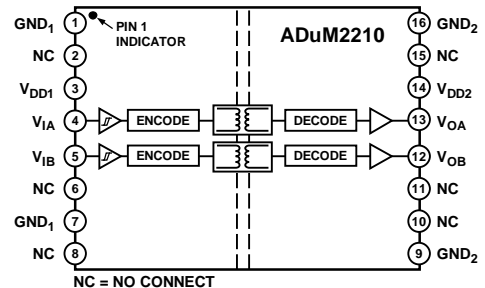

Figure 1. ADuM2210

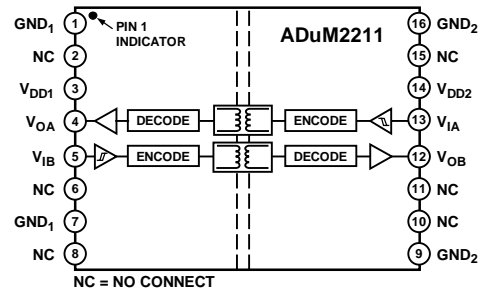

Figure 2. ADuM2211

Typical optocoupler concerns regarding uncertain current transfer ratios, nonlinear transfer functions, and temperature and lifetime effects are eliminated with the simple iCoupler digital interfaces and stable performance characteristics. The need for external drivers and other discrete components is eliminated with these iCoupler products. Furthermore, iCoupler devices run at one-tenth to one-sixth the power of optocouplers at comparable signal data rates.

The ADuM2210/ADuM2211 isolators provide two independent isolation channels in a variety of channel configurations and data rates (see the Ordering Guide). They operate with the supply voltage of either side ranging from 3.0 V to 5.5 V, providing compatibility with lower voltage systems as well as enabling voltage translation functionality across the isolation barrier. The ADuM2210W and ADuM2211W are automotive grade versions.

Similar to the ADuM3200/ADuM3201 isolators, the ADuM2210/ADuM2211 isolators contain various circuit and layout enhancements to provide increased capability relative to system-level IEC 61000-4-x testing (ESD, burst, and surge). The precise capability in these tests for either the ADuM3200/ADuM3201 or ADuM2210/ADuM2211 products is strongly determined by the design and layout of the user's board or module. For more information, see the AN-793 Application Note, *ESD/Latch-Up Considerations with iCoupler Isolation Products*.

TABLE OF CONTENTS

Features	1
Applications	1
General Description	1
Functional Block Diagrams	1
Revision History	2
Specifications	3
Electrical Characteristics—5 V Operation	3
Electrical Characteristics—3.3 V Operation	4
Electrical Characteristics—Mixed 5 V/3.3 V Operation	5
Electrical Characteristics—Mixed 3.3 V/5 V Operation	6
Package Characteristics	7
Regulatory Information	7
Insulation and Safety-Related Specifications	7
DIN V VDE V 0884-10 (VDE V 0884-10) Insulation Characteristics	8

REVISION HISTORY

9/15—Rev. E to Rev. F

Changed 3 V Operation to 3.3 V Operation	Throughout
Changes to Features Section	1
Changes to Table 2 and Table 3	3
Changes to Table 5 and Table 6	4
Changes to Table 8 and Table 9	5
Changes to Table 11 and Table 12	6

3/15—Rev. D to Rev. E

Changed ADuM221x to ADuM2210/ADuM2211	Throughout
Changed ADuM320x to ADuM3200/ADuM3201	Throughout
Changes to Table 15	7

8/12—Rev. C to Rev. D

Changes to Table 4 and Table 6	4
Changes to Table 7 and Table 9	5
Changes to Table 10 and Table 12	6
Updated Outline Dimensions	16
Changes to Ordering Guide	17

6/12—Rev. B to Rev. C

Changes to Features Section, Applications Section, and General Description Section	1
Changes to Table 1; Added Table 2 and Table 3, Renumbered Sequentially	3
Changes to Table 4; Added Table 5 and Table 6	4

Recommended Operating Conditions	8
Absolute Maximum Ratings	9
ESD Caution	9
Pin Configurations and Function Descriptions	10
Typical Performance Characteristics	12
Applications Information	13
PCB Layout	13
Propagation Delay-Related Parameters	13
DC Correctness and Magnetic Field Immunity	13
Power Consumption	14
Insulation Lifetime	15
Outline Dimensions	16
Ordering Guide	17
Automotive Products	17

Changed Electrical Characteristics—Mixed 5 V/3 V or 3 V/5 V Operation Section to Electrical Characteristics—Mixed 5 V/3 V Operation Section	5
Changes to Table 7; Added Table 8 and Table 9	5
Added Electrical Characteristics—Mixed 3 V/5 V Operation, Section, Table 10, Table 11, and Table 12	6
Changes to Table 19	12
Changes to Ordering Guide	20
Added Automotive Products Section	20

2/12—Rev. A to Rev. B

Created Hyperlink for Safety and Regulatory Approvals Entry in Features Section	1
Change to PCB Layout Section	16
Updated Outline Dimensions	19

8/11—Rev. 0 to Rev. A

Added 16-Lead SOIC_IC Package	Universal
Changes to Features Section	1
Changes to Table 5 and Table 6	10
Changes to Endnote 1, Table 8	11
Updated Outline Dimensions	19
Changes to Ordering Guide	20

9/10—Revision 0: Initial Version

SPECIFICATIONS

ELECTRICAL CHARACTERISTICS—5 V OPERATION

All voltages are relative to their respective ground. $4.5\text{ V} \leq V_{DD1} \leq 5.5\text{ V}$, $4.5\text{ V} \leq V_{DD2} \leq 5.5\text{ V}$. All minimum/maximum specifications apply over the entire recommended operation range, $-40^\circ\text{C} \leq T_A \leq 125^\circ\text{C}$, unless otherwise noted. All typical specifications are at $T_A = 25^\circ\text{C}$, $V_{DD1} = V_{DD2} = 5\text{ V}$.

Table 1.

Parameter	Symbol	S Grade			T Grade			Unit	Test Conditions/Comments
		Min	Typ	Max	Min	Typ	Max		
SWITCHING SPECIFICATIONS									
Pulse Width	PW	1000			100			ns	Within PWD limit
Data Rate				1			10	Mbps	Within PWD limit
Propagation Delay	t_{PHL} , t_{PLH}	20		150	20		50	ns	50% input to 50% output
Pulse Width Distortion	PWD			40			3	ns	$ t_{PLH} - t_{PHL} $
Change vs. Temperature						5		ps/°C	
Propagation Delay Skew	t_{PSK}			100			15	ns	Between any two units
Channel Matching									
Codirectional	t_{PSKCD}			50			3	ns	
Opposing-Direction	t_{PSKOD}			50			17	ns	

Table 2.

Parameter	Symbol	1 Mbps, S Grade			10 Mbps, T Grade			Unit	Test Conditions/Comments
		Min	Typ	Max	Min	Typ	Max		
SUPPLY CURRENT									
ADuM2210	I_{DD1}		1.3	1.7		3.5	4.8	mA	No load
	I_{DD2}		1.0	1.6		1.7	2.8	mA	
ADuM2211	I_{DD1}		1.1	1.5		2.6	4.0	mA	
	I_{DD2}		1.3	1.8		3.1	4.1	mA	

Table 3.

Parameter	Symbol	Min	Typ	Max	Unit	Test Conditions/Comments ¹
DC SPECIFICATIONS						
Logic High Input Threshold	V_{IH}	$0.7V_{DDX}$			V	
Logic Low Input Threshold	V_{IL}				V	
Logic High Output Voltages	V_{OH}	$V_{DDX} - 0.1$	5.0		V	$I_{Ox} = -20\ \mu\text{A}$, $V_{Ix} = V_{IxH}$
		$V_{DDX} - 0.5$	4.8		V	$I_{Ox} = -3.2\ \text{mA}$, $V_{Ix} = V_{IxH}$
Logic Low Output Voltages	V_{OL}	0.0			V	$I_{Ox} = 20\ \mu\text{A}$, $V_{Ix} = V_{IxL}$
		0.2			V	$I_{Ox} = 3.2\ \text{mA}$, $V_{Ix} = V_{IxL}$
Input Current per Channel	I_i	-10	+0.01	+10	μA	$0\text{ V} \leq V_{Ix} \leq V_{DDX}$
Supply Current per Channel						
Quiescent Input Supply Current	$I_{DD1(Q)}$	0.4			mA	
Quiescent Output Supply Current	$I_{DDO(Q)}$	0.5			mA	
Dynamic Input Supply Current	$I_{DD1(D)}$	0.19			mA/Mbps	
Dynamic Output Supply Current	$I_{DDO(D)}$	0.05			mA/Mbps	
AC SPECIFICATIONS						
Output Rise/Fall Time	t_R/t_F				ns	10% to 90%
ADuM2210/ADuM2211 S Grade		10			ns	10% to 90%
ADuM2210/ADuM2211 T Grade		2.5			ns	10% to 90%
Common-Mode Transient Immunity ²	$ CM $	25	35		kV/ μs	$V_{Ix} = V_{DDX}$, $V_{CM} = 1000\text{ V}$, transient magnitude = 800 V
Refresh Period	T_r	1.6			μs	

¹ I_{Ox} is the Channel x output current, where x = A or B, V_{IxH} is the input side logic high, and V_{IxL} is the input side logic low.

² $|CM|$ is the maximum common-mode voltage slew rate that can be sustained while maintaining $V_O > 0.8 V_{DDX}$. The common-mode voltage slew rates apply to both rising and falling common-mode voltage edges.

ELECTRICAL CHARACTERISTICS—3.3 V OPERATION

All voltages are relative to their respective ground. $3.0\text{ V} \leq V_{DD1} \leq 3.6\text{ V}$, $3.0\text{ V} \leq V_{DD2} \leq 3.6\text{ V}$. All minimum/maximum specifications apply over the entire recommended operation range, $-40^\circ\text{C} \leq T_A \leq 125^\circ\text{C}$, unless otherwise noted. All typical specifications are at $T_A = 25^\circ\text{C}$, $V_{DD1} = V_{DD2} = 3.3\text{ V}$.

Table 4.

Parameter	Symbol	S Grade			T Grade			Unit	Test Conditions/Comments
		Min	Typ	Max	Min	Typ	Max		
SWITCHING SPECIFICATIONS									
Pulse Width	PW	1000			100			ns	Within PWD limit
Data Rate			1			10		Mbps	Within PWD limit
Propagation Delay	t_{PHL} , t_{PLH}	20		150	20		60	ns	50% input to 50% output
Pulse Width Distortion	PWD								$ t_{PLH} - t_{PHL} $
S Grade and T Grade				40			3	ns	
W Grade				40			4	ns	
Change vs. Temperature						5		ps/°C	
Propagation Delay Skew	t_{PSK}			100			22	ns	Between any two units
Channel Matching									
Codirectional	t_{PSKCD}			50			3	ns	
Opposing-Direction	t_{PSKOD}			50			22	ns	

Table 5.

Parameter	Symbol	1 Mbps, S Grade			10 Mbps, T Grade			Unit	Test Conditions/Comments
		Min	Typ	Max	Min	Typ	Max		
SUPPLY CURRENT									
ADuM2210	I_{DD1}	0.8	1.3		2.0	3.2		mA	No load
	I_{DD2}	0.7	1.0		1.1	1.9		mA	
ADuM2211	I_{DD1}	0.7	1.3		1.5	2.6		mA	
	I_{DD2}	0.8	1.6		1.9	2.5		mA	

Table 6.

Parameter	Symbol	Min	Typ	Max	Unit	Test Conditions/Comments ¹
DC SPECIFICATIONS						
Logic High Input Threshold	V_{IH}	0.7 V_{DDX}			V	
Logic Low Input Threshold	V_{IL}				0.3 V_{DDX}	V
Logic High Output Voltages	V_{OH}	$V_{DDX} - 0.1$	3.0		V	$I_{Ox} = -20\ \mu\text{A}$, $V_{Ix} = V_{IxH}$
		$V_{DDX} - 0.5$	2.8		V	$I_{Ox} = -3.2\ \text{mA}$, $V_{Ix} = V_{IxH}$
Logic Low Output Voltages	V_{OL}		0.0	0.1	V	$I_{Ox} = 20\ \mu\text{A}$, $V_{Ix} = V_{IxL}$
			0.2	0.40	V	$I_{Ox} = 3.2\ \text{mA}$, $V_{Ix} = V_{IxL}$
Input Current per Channel	I_I	-10	+0.01	+10	μA	$0\text{ V} \leq V_{Ix} \leq V_{DDX}$
Supply Current per Channel						
Quiescent Input Supply Current	$I_{DD1(Q)}$		0.3	0.5	mA	
Quiescent Output Supply Current	$I_{DDO(Q)}$		0.3	0.5	mA	
Dynamic Input Supply Current	$I_{DD1(D)}$		0.10		mA/Mbps	
Dynamic Output Supply Current	$I_{DDO(D)}$		0.03		mA/Mbps	
AC SPECIFICATIONS						
Output Rise/Fall Time	t_R/t_F		10		ns	10% to 90%
ADuM2210/ADuM2211 S Grade			3		ns	10% to 90%
ADuM2210/ADuM2211 T Grade						
Common-Mode Transient Immunity ²	$ CM $	25	35		kV/ μs	$V_{Ix} = V_{DDX}$, $V_{CM} = 1000\text{ V}$, transient magnitude = 800 V
Refresh Period	T_r		1.8		μs	

¹ I_{Ox} is the Channel x output current, where x = A or B, V_{IxH} is the input side logic high, and V_{IxL} is the input side logic low.

² $|CM|$ is the maximum common-mode voltage slew rate that can be sustained while maintaining $V_O > 0.8 V_{DDX}$. The common-mode voltage slew rates apply to both rising and falling common-mode voltage edges.

ELECTRICAL CHARACTERISTICS—MIXED 5 V/3.3 V OPERATION

All voltages are relative to their respective ground. $4.5\text{ V} \leq V_{DD1} \leq 5.5\text{ V}$, $3.0\text{ V} \leq V_{DD2} \leq 3.6\text{ V}$. All minimum/maximum specifications apply over the entire recommended operation range, $-40^\circ\text{C} \leq T_A \leq 125^\circ\text{C}$, unless otherwise noted. All typical specifications are at $T_A = 25^\circ\text{C}$, $V_{DD1} = 5\text{ V}$, $V_{DD2} = 3.3\text{ V}$.

Table 7.

Parameter	Symbol	S Grade			T Grade			Unit	Test Conditions/Comments
		Min	Typ	Max	Min	Typ	Max		
SWITCHING SPECIFICATIONS									
Pulse Width	PW	1000			100			ns	Within PWD limit
Data Rate				1			10	Mbps	Within PWD limit
Propagation Delay	t_{PHL} , t_{PLH}	15		150	15		55	ns	50% input to 50% output
Pulse Width Distortion	PWD			40			3	ns	$ t_{PLH} - t_{PHL} $
S Grade and T Grade				40			3	ns	
W Grade				40			4	ns	
Change vs. Temperature							5	ps/°C	
Propagation Delay Skew	t_{PSK}			50			22	ns	Between any two units
Channel Matching									
Codirectional	t_{PSKCD}			50			3	ns	
Opposing-Direction	t_{PSKOD}			50			22	ns	

Table 8.

Parameter	Symbol	1 Mbps, S Grade			10 Mbps, T Grade			Unit	Test Conditions/Comments
		Min	Typ	Max	Min	Typ	Max		
SUPPLY CURRENT									
ADuM2210	I_{DD1}	1.3	1.7		3.5	4.8		mA	No load
	I_{DD2}	0.7	1.0		1.1	1.9		mA	
ADuM2211	I_{DD1}	1.1	1.5		2.6	4.0		mA	
	I_{DD2}	0.8	1.6		1.9	2.5		mA	

Table 9.

Parameter	Symbol	Min	Typ	Max	Unit	Test Conditions/Comments ¹
DC SPECIFICATIONS						
Logic High Input Threshold	V_{IH}	0.7 V_{DDX}			V	
Logic Low Input Threshold	V_{IL}				0.3 V_{DDX}	
Logic High Output Voltages	V_{OH}	$V_{DDX} - 0.1$	V_{DDX}		V	$I_{Ox} = -20\ \mu\text{A}$, $V_{Ix} = V_{IxH}$
		$V_{DDX} - 0.5$	$V_{DDX} - 0.2$		V	
Logic Low Output Voltages	V_{OL}	0.0		0.1	V	$I_{Ox} = 20\ \mu\text{A}$, $V_{Ix} = V_{IxL}$
		0.2		0.40	V	
Input Current per Channel	I_i	-10	+0.01	+10	μA	$0\text{ V} \leq V_{Ix} \leq V_{DDX}$
Supply Current per Channel						
Quiescent Input Supply Current	$I_{DDI(Q)}$		0.4	0.8	mA	
Quiescent Output Supply Current	$I_{DDO(Q)}$		0.3	0.5	mA	
Dynamic Input Supply Current	$I_{DDI(D)}$		0.19		mA/Mbps	
Dynamic Output Supply Current	$I_{DDO(D)}$		0.03		mA/Mbps	
AC SPECIFICATIONS						
Output Rise/Fall Time	t_R/t_F					
ADuM2210/ADuM2211 S Grade			10		ns	10% to 90%
ADuM2210/ADuM2211 T Grade			3		ns	10% to 90%
Common-Mode Transient Immunity ²	CM	25	35		kV/ μs	$V_{Ix} = V_{DDX}$, $V_{CM} = 1000\text{ V}$, transient magnitude = 800 V
Refresh Period	T_r		1.6		μs	

¹ I_{Ox} is the Channel x output current, where x = A or B, V_{IxH} is the input side logic high, and V_{IxL} is the input side logic low.

² |CM| is the maximum common-mode voltage slew rate that can be sustained while maintaining $V_O > 0.8 V_{DDX}$. The common-mode voltage slew rates apply to both rising and falling common-mode voltage edges.

ELECTRICAL CHARACTERISTICS—MIXED 3.3 V/5 V OPERATION

All voltages are relative to their respective ground. $3.0\text{ V} \leq V_{DD1} \leq 3.6\text{ V}$, $4.5\text{ V} \leq V_{DD2} \leq 5.5\text{ V}$. All minimum/maximum specifications apply over the entire recommended operation range, $-40^\circ\text{C} \leq T_A \leq 125^\circ\text{C}$, unless otherwise noted. All typical specifications are at $T_A = 25^\circ\text{C}$, $V_{DD1} = 3.3\text{ V}$, $V_{DD2} = 5\text{ V}$.

Table 10.

Parameter	Symbol	S Grade			T Grade			Unit	Test Conditions/Comments
		Min	Typ	Max	Min	Typ	Max		
SWITCHING SPECIFICATIONS									
Pulse Width	PW	1000			100			ns	Within PWD limit
Data Rate			1			10		Mbps	Within PWD limit
Propagation Delay	t_{PHL} , t_{PLH}	15		150	15		55	ns	50% input to 50% output
Pulse Width Distortion	PWD			40			3	ns	$ t_{PLH} - t_{PHL} $
S Grade and T Grade				40			3	ns	
W Grade				40			4	ns	
Change vs. Temperature						5		ps/°C	
Propagation Delay Skew	t_{PSK}			50			22	ns	Between any two units
Channel Matching									
Codirectional	t_{PSKCD}			50			3	ns	
Opposing-Direction	t_{PSKOD}			50			22	ns	

Table 11.

Parameter	Symbol	1 Mbps, S Grade			10 Mbps, T Grade			Unit	Test Conditions/Comments
		Min	Typ	Max	Min	Typ	Max		
SUPPLY CURRENT									
ADuM2210	I_{DD1}		0.8	1.3		2.0	3.2	mA	No load
	I_{DD2}		1.0	1.6		1.7	2.8	mA	
ADuM2211	I_{DD1}		0.7	1.3		1.5	2.6	mA	
	I_{DD2}		1.3	1.8		3.1	4.1	mA	

Table 12.

Parameter	Symbol	Min	Typ	Max	Unit	Test Conditions/Comments ¹
DC SPECIFICATIONS						
Logic High Input Threshold	V_{IH}	$0.7V_{DDX}$			V	
Logic Low Input Threshold	V_{IL}				$0.3V_{DDX}$	
Logic High Output Voltages	V_{OH}	$V_{DDX} - 0.1$	V_{DDX}		V	$I_{Ox} = -20\text{ }\mu\text{A}$, $V_{Ix} = V_{IxH}$
		$V_{DDX} - 0.5$	$V_{DDX} - 0.2$		V	
Logic Low Output Voltages	V_{OL}	0.0		0.1	V	$I_{Ox} = 20\text{ }\mu\text{A}$, $V_{Ix} = V_{IxL}$
		0.2		0.40	V	
Input Current per Channel	I_i	-10	+0.01	+10	μA	$0\text{ V} \leq V_{Ix} \leq V_{DDX}$
Supply Current per Channel						
Quiescent Input Supply Current	$I_{DD1(Q)}$	0.3		0.5	mA	
Quiescent Output Supply Current	$I_{DDO(Q)}$	0.5		0.6	mA	
Dynamic Input Supply Current	$I_{DD1(D)}$	0.10			mA/Mbps	
Dynamic Output Supply Current	$I_{DDO(D)}$	0.05			mA/Mbps	
AC SPECIFICATIONS						
Output Rise/Fall Time	t_R/t_F				ns	10% to 90%
ADuM2210/ADuM2211 S Grade		10				
ADuM2210/ADuM2211 T Grade		2.5				
Common-Mode Transient Immunity ²	CM	25	35		kV/ μs	$V_{Ix} = V_{DDX}$, $V_{CM} = 1000\text{ V}$, transient magnitude = 800 V
Refresh Period	T_r	1.8			μs	

¹ I_{Ox} is the Channel x output current, where x = A or B, V_{IxH} is the input side logic high, and V_{IxL} is the input side logic low.

² |CM| is the maximum common-mode voltage slew rate that can be sustained while maintaining $V_O > 0.8 V_{DDX}$. The common-mode voltage slew rates apply to both rising and falling common-mode voltage edges.

PACKAGE CHARACTERISTICS

Table 13.

Parameter	Symbol	Min	Typ	Max	Unit	Test Conditions
Resistance (Input-to-Output) ¹	R _{I-O}		10 ¹²		Ω	f = 1 MHz
Capacitance (Input-to-Output) ¹	C _{I-O}		2.2		pF	
Input Capacitance ²	C _I		4.0		pF	Thermocouple located at center of package underside
IC Junction-to-Case Thermal Resistance, Side 1	θ _{JCI}		33		°C/W	
IC Junction-to-Case Thermal Resistance, Side 2	θ _{JCO}		28		°C/W	

¹ Device considered a 2-terminal device: Pin 1 through Pin 8 are shorted together and Pin 9 through Pin 16 are shorted together.

² Input capacitance is from any input data pin to ground.

REGULATORY INFORMATION

The ADuM2210/ADuM2211 are approved by the organizations listed in Table 14. Refer to Table 19 and the Insulation Lifetime section for details regarding recommended maximum working voltages for specific cross-isolation waveforms and insulation levels.

Table 14.

UL	CSA	VDE
Recognized under 1577 Component Recognition Program ¹	Approved under CSA Component Acceptance Notice 5A	Certified according to DIN V VDE V 0884-10 (VDE V 0884-10): 2006-12 ²
Single Protection 5000 V rms Isolation Voltage	Basic insulation per CSA 60950-1-07 and IEC 60950-1, 600 V rms (848 V peak) maximum working voltage RW-16 package: Reinforced insulation per CSA 60950-1-07 and IEC 60950-1, 380 V rms (537 V peak) maximum working voltage; reinforced insulation per IEC 60601-1 125 V rms (176 V peak) maximum working voltage RI-16 package: Reinforced insulation per CSA 60950-1-07 and IEC 60950-1, 400 V rms (565 V peak) maximum working voltage; reinforced insulation per IEC 60601-1 250 V rms (353 V peak) maximum working voltage	Reinforced insulation, 846 V peak
File E214100	File 205078	File 2471900 4880-0001

¹ In accordance with UL1577, each ADuM2210/ADuM2211 is proof tested by applying an insulation test voltage ≥ 6000 V rms for 1 second (current leakage detection limit = 10 μA).

² In accordance with DIN V VDE V 0884-10, each ADuM2210/ADuM2211 is proof tested by applying an insulation test voltage ≥ 1590 V peak for 1 sec (partial discharge detection limit = 5 pC). The * marking branded on the component designates DIN V VDE V 0884-10 approval.

INSULATION AND SAFETY-RELATED SPECIFICATIONS

Table 15.

Parameter	Symbol	Value	Unit	Conditions
Rated Dielectric Insulation Voltage		5000	V rms	1-minute duration
Minimum External Air Gap	L(I01)	8.0 min	mm	Distance measured from input terminals to output terminals, shortest distance through air along the PCB mounting plane, as an aid to PC board layout
Minimum External Tracking (Creepage) RW-16 Package	L(I02)	7.7 min	mm	Measured from input terminals to output terminals, shortest distance path along body
Minimum External Tracking (Creepage) RI-16 Package	L(I02)	8.3 min	mm	Measured from input terminals to output terminals, shortest distance path along body
Minimum Internal Gap (Internal Clearance)		0.017 min	mm	Insulation distance through insulation
Tracking Resistance (Comparative Tracking Index)	CTI	>400	V	DIN IEC 112/VDE 0303 Part 1
Isolation Group		II		Material Group (DIN VDE 0110, 1/89, Table 1)

DIN V VDE V 0884-10 (VDE V 0884-10) INSULATION CHARACTERISTICS

These isolators are suitable for reinforced electrical isolation only within the safety limit data. Maintenance of the safety data is ensured by means of protective circuits. Note that the asterisk (*) branded on packages denotes DIN V VDE V 0884-10 approval for 846 V peak working voltage.

Table 16.

Description	Test Conditions/Comments	Symbol	Characteristic	Unit
Installation Classification per DIN VDE 0110 For Rated Mains Voltage ≤ 300 V rms For Rated Mains Voltage ≤ 450 V rms For Rated Mains Voltage ≤ 600 V rms			I to IV I to II I to II	
Climatic Classification			40/125/21	
Pollution Degree (DIN VDE 0110, Table 1)			2	
Maximum Working Insulation Voltage		V _{IORM}	846	V peak
Input-to-Output Test Voltage, Method B1	V _{IORM} × 1.875 = V _{PR} , 100% production test, t _m = 1 sec, partial discharge < 5 pC	V _{PR}	1590	V peak
Input-to-Output Test Voltage, Method A		V _{PR}		
After Environmental Tests Subgroup 1	V _{IORM} × 1.6 = V _{PR} , t _m = 60 sec, partial discharge < 5 pC		1375	V peak
After Input and/or Safety Test Subgroup 2 and Subgroup 3	V _{IORM} × 1.2 = V _{PR} , t _m = 60 sec, partial discharge < 5 pC		1018	V peak
Highest Allowable Overvoltage	Transient overvoltage, t _{TR} = 10 seconds	V _{TR}	6000	V peak
Safety-Limiting Values	Maximum value allowed in the event of a failure; see Figure 3			
Case Temperature		T _S	150	°C
Side 1 Current		I _{S1}	265	mA
Side 2 Current		I _{S2}	335	mA
Insulation Resistance at T _S	V _{IO} = 500 V	R _S	>10 ⁹	Ω

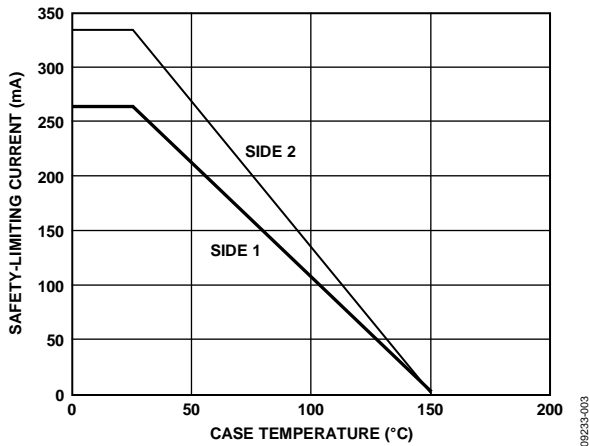

Figure 3. Thermal Derating Curve, Dependence of Safety Limiting Values with Case Temperature per DIN V VDE V 0884-10

RECOMMENDED OPERATING CONDITIONS

Table 17.

Parameter	Symbol	Min	Max	Unit
Operating Temperature	T _A	-40	+125	°C
Supply Voltages ¹	V _{DD1} , V _{DD2}	3.0	5.5	V
Input Signal Rise and Fall Times			1.0	ms

¹ All voltages are relative to their respective ground.

ABSOLUTE MAXIMUM RATINGS

Table 18.

Parameter	Rating
Storage Temperature (T_{ST})	-65°C to +150°C
Ambient Operating Temperature (T_A)	-40°C to +125°C
Supply Voltage (V_{DD1} , V_{DD2}) ¹	-0.5 V to +7.0 V
Input Voltage (V_{IA} , V_{IB}) ^{1, 2}	-0.5 V to $V_{DD1} + 0.5$ V
Output Voltage (V_{OA} , V_{OB}) ^{1, 2}	-0.5 V to $V_{DDO} + 0.5$ V
Average Output Current per Pin ³	
Side 1 (I_{O1})	-18 mA to +18 mA
Side 2 (I_{O2})	-22 mA to +22 mA
Common-Mode Transients ⁴	-100 kV/ μ s to +100 kV/ μ s

¹ All voltages are relative to their respective ground.

² V_{DD1} and V_{DDO} refer to the supply voltages on the input and output sides of a given channel, respectively. See the PCB Layout section.

³ See Figure 3 for maximum rated current values for various temperatures.

⁴ Refers to common-mode transients across the insulation barrier. Common-mode transients exceeding the Absolute Maximum Rating can cause latch-up or permanent damage.

Stresses at or above those listed under Absolute Maximum Ratings may cause permanent damage to the product. This is a stress rating only; functional operation of the product at these or any other conditions above those indicated in the operational section of this specification is not implied. Operation beyond the maximum operating conditions for extended periods may affect product reliability.

ESD CAUTION



ESD (electrostatic discharge) sensitive device. Charged devices and circuit boards can discharge without detection. Although this product features patented or proprietary protection circuitry, damage may occur on devices subjected to high energy ESD. Therefore, proper ESD precautions should be taken to avoid performance degradation or loss of functionality.

Table 19. Maximum Continuous Working Voltage¹

Parameter	Max	Unit	Constraint
AC Voltage, Bipolar Waveform	565	V peak	50-year minimum lifetime
AC Voltage, Unipolar Waveform	1130	V peak	50-year minimum lifetime
DC Voltage	1130	V peak	50-year minimum lifetime

¹ Refers to continuous voltage magnitude imposed across the isolation barrier. See the Insulation Lifetime section for more details.

Table 20. ADuM2210 Truth Table (Positive Logic)

V_{IA} Input ¹	V_{IB} Input ¹	V_{DD1} State	V_{DD2} State	V_{OA} Output ¹	V_{OB} Output ¹	Notes
H	H	Powered	Powered	H	H	
L	L	Powered	Powered	L	L	
H	L	Powered	Powered	H	L	
L	H	Powered	Powered	L	H	
X	X	Unpowered	Powered	L	L	Outputs return to the input state within 1 μ s of V_{DD1} power restoration.
X	X	Powered	Unpowered	Indeterminate	Indeterminate	Outputs return to the input state within 1 μ s of V_{DDO} power restoration.

¹ H is logic high, L is logic low, and X is don't care.

Table 21. ADuM2211 Truth Table (Positive Logic)

V_{IA} Input ¹	V_{IB} Input ¹	V_{DD1} State	V_{DD2} State	V_{OA} Output ¹	V_{OB} Output ¹	Notes
H	H	Powered	Powered	H	H	
L	L	Powered	Powered	L	L	
H	L	Powered	Powered	H	L	
L	H	Powered	Powered	L	H	
X	X	Unpowered	Powered	Indeterminate	L	Outputs return to the input state within 1 μ s of V_{DD1} power restoration.
X	X	Powered	Unpowered	L	Indeterminate	Outputs return to the input state within 1 μ s of V_{DDO} power restoration.

¹ H is logic high, L is logic low, and X is don't care.

PIN CONFIGURATIONS AND FUNCTION DESCRIPTIONS



NOTES:

- PIN 1 AND PIN 7 ARE INTERNALLY CONNECTED, AND CONNECTING BOTH TO GND₁ IS RECOMMENDED.
- PIN 9 AND PIN 16 ARE INTERNALLY CONNECTED, AND CONNECTING BOTH TO GND₂ IS RECOMMENDED.

09233-004

Figure 4. ADuM2210 Pin Configuration

Table 22. ADuM2210 Pin Function Descriptions

Pin No.	Mnemonic	Description
1	GND ₁	Ground 1. Ground reference for Isolator Side 1.
2	NC	No internal connection.
3	V _{DD1}	Supply Voltage for Isolator Side 1, 3.0 V to 5.5 V.
4	V _{IA}	Logic Input A.
5	V _{IB}	Logic Input B.
6	NC	No internal connection.
7	GND ₁	Ground 1. Ground reference for Isolator Side 1.
8	NC	No internal connection.
9	GND ₂	Ground 2. Ground reference for Isolator Side 2.
10	NC	No internal connection.
11	NC	No internal connection.
12	V _{OB}	Logic Output B.
13	V _{OA}	Logic Output A.
14	V _{DD2}	Supply Voltage for Isolator Side 2, 3.0 V to 5.5 V.
15	NC	No internal connection.
16	GND ₂	Ground 2. Ground reference for Isolator Side 2.

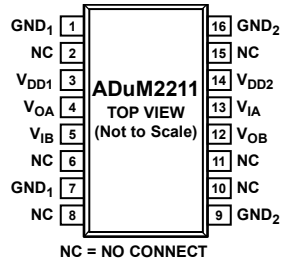

- NOTES:
1. PIN 1 AND PIN 7 ARE INTERNALLY CONNECTED, AND CONNECTING BOTH TO GND₁ IS RECOMMENDED.
 2. PIN 9 AND PIN 16 ARE INTERNALLY CONNECTED, AND CONNECTING BOTH TO GND₂ IS RECOMMENDED.

068233-005

Figure 5. ADuM2211 Pin Configuration

Table 23. ADuM2211 Pin Function Descriptions

Pin No.	Mnemonic	Description
1	GND ₁	Ground 1. Ground reference for Isolator Side 1.
2	NC	No internal connection.
3	V _{DD1}	Supply Voltage for Isolator Side 1, 3.0 V to 5.5 V.
4	V _{OA}	Logic Output A.
5	V _{IB}	Logic Input B.
6	NC	No internal connection.
7	GND ₁	Ground 1. Ground reference for Isolator Side 1.
8	NC	No internal connection.
9	GND ₂	Ground 2. Ground reference for Isolator Side 2.
10	NC	No internal connection.
11	NC	No internal connection.
12	V _{OB}	Logic Output B.
13	V _{IA}	Logic Input A.
14	V _{DD2}	Supply Voltage for Isolator Side 2, 3.0 V to 5.5 V.
15	NC	No internal connection.
16	GND ₂	Ground 2. Ground reference for Isolator Side 2.

TYPICAL PERFORMANCE CHARACTERISTICS

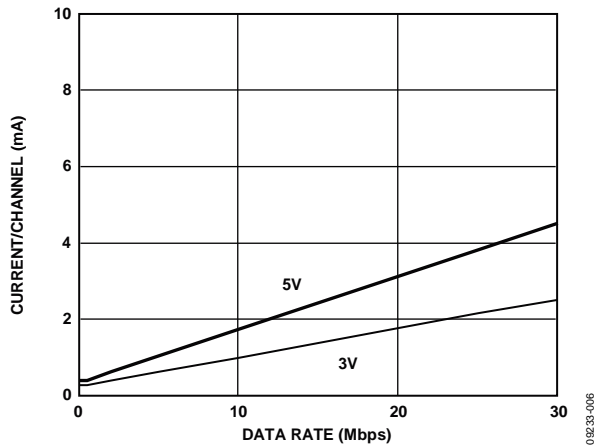

Figure 6. Typical Input Supply Current per Channel vs. Data Rate for 5 V and 3.3 V Operation (No Output Load)

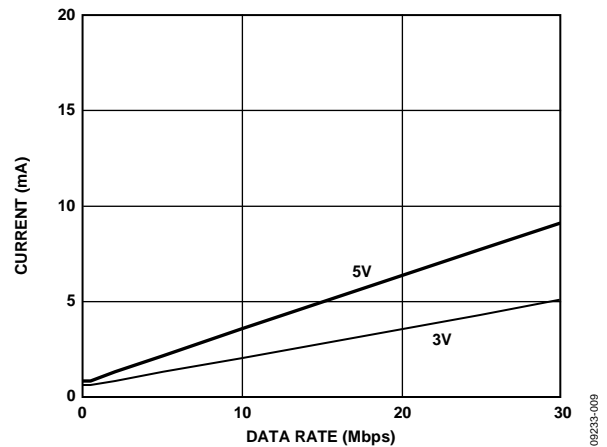

Figure 9. Typical ADuM2210 V_{DD1} Supply Current vs. Data Rate for 5 V and 3.3 V Operation

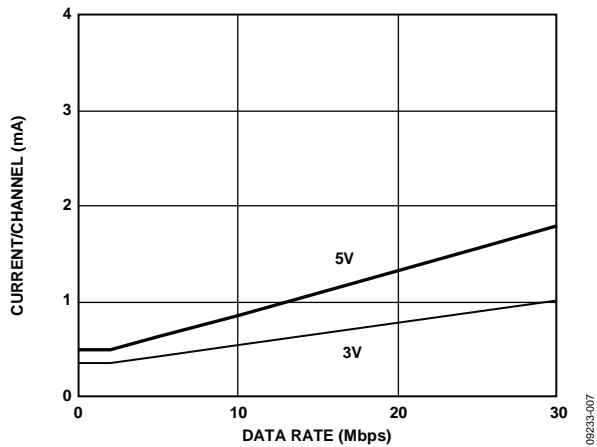

Figure 7. Typical Output Supply Current per Channel vs. Data Rate for 5 V and 3.3 V Operation (No Output Load)

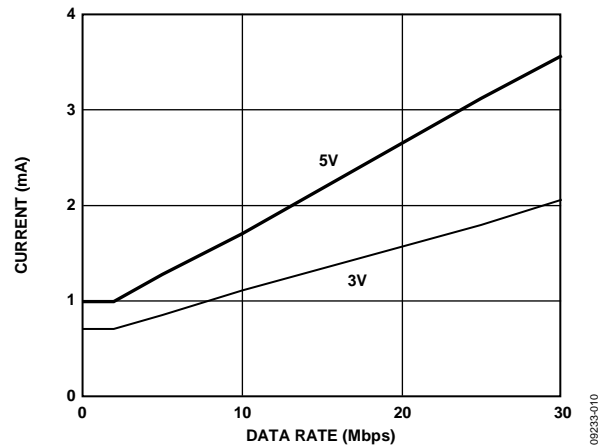

Figure 10. Typical ADuM2210 V_{DD2} Supply Current vs. Data Rate for 5 V and 3.3 V Operation

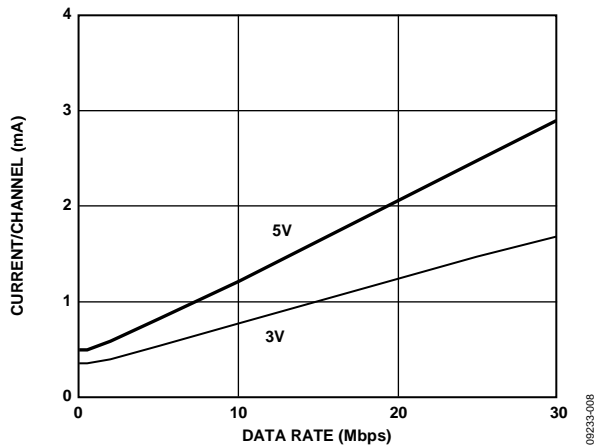

Figure 8. Typical Output Supply Current per Channel vs. Data Rate for 5 V and 3.3 V Operation (15 pF Output Load)

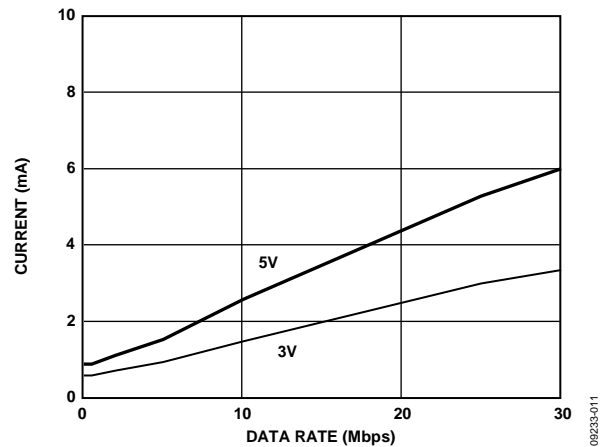

Figure 11. Typical ADuM2211 V_{DD1} or V_{DD2} Supply Current vs. Data Rate for 5 V and 3.3 V Operation

APPLICATIONS INFORMATION

PCB LAYOUT

The ADuM2210/ADuM2211 digital isolator requires no external interface circuitry for the logic interfaces. Power supply bypassing is strongly recommended at the input and output supply pins (see Figure 12). Bypass capacitors are most conveniently connected between Pin 1 and Pin 3 for V_{DD1} and between Pin 14 and Pin 16 for V_{DD2}. The capacitor value should be between 0.01 μF and 0.1 μF. The total lead length between both ends of the capacitor and the input power supply pin should not exceed 20 mm. Bypassing between Pin 3 and Pin 7 and between Pin 9 and Pin 14 should be considered unless the ground pair on each package side is connected close to the package.

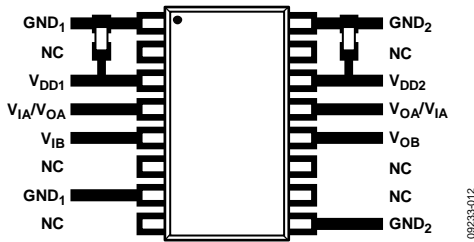

Figure 12. Recommended Printed Circuit Board Layout

In applications involving high common-mode transients, care should be taken to ensure that board coupling across the isolation barrier is minimized. Furthermore, the board layout should be designed such that any coupling that does occur equally affects all pins on a given component side. Failure to ensure this could cause voltage differentials between pins exceeding the Absolute Maximum Ratings of the device, thereby leading to latch-up or permanent damage.

See the AN-1109 Application Note for board layout guidelines.

PROPAGATION DELAY-RELATED PARAMETERS

Propagation delay is a parameter that describes the length of time it takes for a logic signal to propagate through a component. The propagation delay to a logic low output can differ from the propagation delay to logic high.



Figure 13. Propagation Delay Parameters

Pulse width distortion is the maximum difference between these two propagation delay values and is an indication of how accurately the input signal's timing is preserved.

Channel-to-channel matching refers to the maximum amount the propagation delay differs among channels within a single ADuM2210/ADuM2211 component.

Propagation delay skew refers to the maximum amount the propagation delay differs among multiple ADuM2210/ADuM2211 components operated under the same conditions.

DC CORRECTNESS AND MAGNETIC FIELD IMMUNITY

Positive and negative logic transitions at the isolator input cause narrow (~1 ns) pulses to be sent via the transformer to the decoder. The decoder is bistable and is, therefore, either set or reset by the pulses, indicating input logic transitions. In the absence of logic transitions at the input for more than ~1 μs, a periodic set of refresh pulses indicative of the correct input state is sent to ensure dc correctness at the output. If the decoder receives no internal pulses for more than approximately 5 μs, the input side is assumed to be without power or nonfunctional; in which case, the isolator output is forced to a default state (see Table 20 and Table 21) by the watchdog timer circuit.

The limitation on the ADuM2210/ADuM2211 magnetic field immunity is set by the condition in which induced voltage in the transformer receiving coil is large enough to either falsely set or reset the decoder. The following analysis defines the conditions under which this can occur. The 3.3 V operating condition of the ADuM2210/ADuM2211 is examined because it represents the most susceptible mode of operation.

The pulses at the transformer output have an amplitude greater than 1.0 V. The decoder has a sensing threshold at about 0.5 V, therefore establishing a 0.5 V margin in which induced voltages can be tolerated. The voltage induced across the receiving coil is given by

$$V = (-d\beta/dt)\Sigma\pi r_n^2; n = 1, 2, \dots, N$$

where:

β is the magnetic flux density (gauss).

N is the number of turns in the receiving coil.

r_n is the radius of the n^{th} turn in the receiving coil (cm).

Given the geometry of the receiving coil in the ADuM2210/ADuM2211 and an imposed requirement that the induced voltage be at most 50% of the 0.5 V margin at the decoder, a maximum allowable magnetic field is calculated as shown in Figure 14.



Figure 14. Maximum Allowable External Magnetic Flux Density

For example, at a magnetic field frequency of 1 MHz, the maximum allowable magnetic field of 0.2 kgauss induces a voltage of 0.25 V at the receiving coil. This is about 50% of the sensing threshold and does not cause a faulty output transition. Similarly, if such an event were to occur during a transmitted pulse (and was of the worst-case polarity), it would reduce the received pulse from >1.0 V to 0.75 V—still well above the 0.5 V sensing threshold of the decoder.

The preceding magnetic flux density values correspond to specific current magnitudes at given distances away from the ADuM2210/ADuM2211 transformers. Figure 15 expresses these allowable current magnitudes as a function of frequency for selected distances. As can be seen, the ADuM2210/ADuM2211 is immune and can be affected only by extremely large currents operated at high frequency and very close to the component. For the 1 MHz example noted previously, one would have to place a 0.5 kA current 5 mm away from the ADuM2210/ADuM2211 to affect operation of the component.

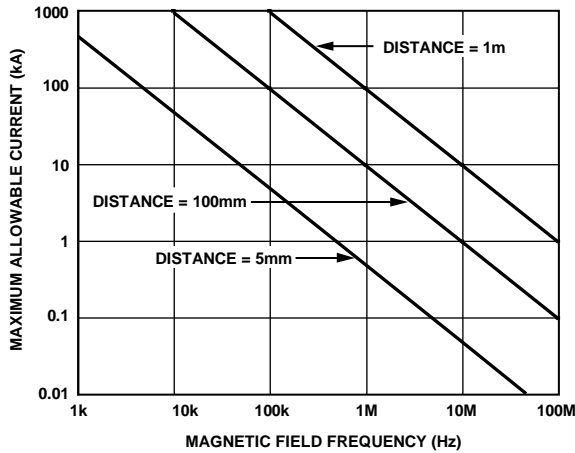

Figure 15. Maximum Allowable Current for Various Current-to-ADuM2210/ADuM2211 Spacings

Note that at combinations of strong magnetic field and high frequency, any loops formed by printed circuit board traces can induce sufficiently large error voltages to trigger the thresholds of succeeding circuitry. Care should be taken in the layout of such traces to avoid this possibility.

POWER CONSUMPTION

The supply current at a given channel of the ADuM2210/ADuM2211 isolator is a function of the supply voltage, the channel’s data rate, and the channel’s output load.

For each input channel, the supply current is given by

$$I_{DDI} = I_{DDI(Q)} \quad f \leq 0.5f_r$$

$$I_{DDI} = I_{DDI(D)} \times (2f - f_r) + I_{DDI(Q)} \quad f > 0.5f_r$$

For each output channel, the supply current is given by

$$I_{DDO} = I_{DDO(Q)} \quad f \leq 0.5f_r$$

$$I_{DDO} = (I_{DDO(D)} + (0.5 \times 10^{-3}) \times C_L \times V_{DDO}) \times (2f - f_r) + I_{DDO(Q)} \quad f > 0.5f_r$$

where:

$I_{DDI(D)}$, $I_{DDO(D)}$ are the input and output dynamic supply currents per channel (mA/Mbps).

C_L is the output load capacitance (pF).

V_{DDO} is the output supply voltage (V).

f is the input logic signal frequency (MHz, half of the input data rate, NRZ signaling).

f_r is the input stage refresh rate (Mbps).

$I_{DDI(Q)}$, $I_{DDO(Q)}$ are the specified input and output quiescent supply currents (mA).

To calculate the total I_{DD1} and I_{DD2} , the supply currents for each input and output channel corresponding to I_{DD1} and I_{DD2} are calculated and totaled. Figure 6 and Figure 7 provide per-channel supply currents as a function of data rate for an unloaded output condition. Figure 8 provides per-channel supply current as a function of data rate for a 15 pF output condition. Figure 9 through Figure 11 provide total I_{DD1} and I_{DD2} as a function of data rate for ADuM2210/ADuM2211 channel configurations.

INSULATION LIFETIME

All insulation structures eventually break down when subjected to voltage stress over a sufficiently long period. The rate of insulation degradation is dependent on the characteristics of the voltage waveform applied across the insulation. In addition to the testing performed by the regulatory agencies, Analog Devices carries out an extensive set of evaluations to determine the lifetime of the insulation structure within the [ADuM2210/ADuM2211](#).

Analog Devices performs accelerated life testing using voltage levels higher than the rated continuous working voltage. Acceleration factors for several operating conditions are determined. These factors allow calculation of the time to failure at the actual working voltage. The values shown in Table 19 summarize the peak voltage for 50 years of service life for a bipolar ac operating condition and the maximum CSA/VDE approved working voltages. In many cases, the approved working voltage is higher than a 50-year service life voltage. Operation at these high working voltages can lead to shortened insulation life in some cases.

The insulation lifetime of the [ADuM2210/ADuM2211](#) depends on the voltage waveform type imposed across the isolation barrier. The iCoupler insulation structure degrades at different rates, depending on whether the waveform is bipolar ac, unipolar ac, or dc. Figure 16, Figure 17, and Figure 18 illustrate these different isolation voltage waveforms.

Bipolar ac voltage is the most stringent environment. The goal of a 50-year operating lifetime under the ac bipolar condition determines the Analog Devices recommended maximum working voltage.

In the case of unipolar ac or dc voltage, the stress on the insulation is significantly lower. This allows operation at higher working voltages while still achieving a 50-year service life. The working voltages listed in Table 19 can be applied while maintaining the 50-year minimum lifetime, provided the voltage conforms to either the unipolar ac or dc voltage cases. Any cross-insulation voltage waveform that does not conform to Figure 17 or Figure 18 should be treated as a bipolar ac waveform and its peak voltage should be limited to the 50-year lifetime voltage value listed in Table 19.

Note that the voltage presented in Figure 17 is shown as sinusoidal for illustration purposes only. It is meant to represent any voltage waveform varying between 0 V and some limiting value. The limiting value can be positive or negative, but the voltage cannot cross 0 V.

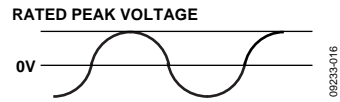

Figure 16. Bipolar AC Waveform

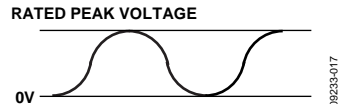

Figure 17. Unipolar AC Waveform

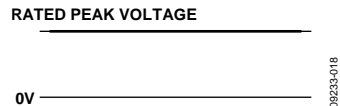
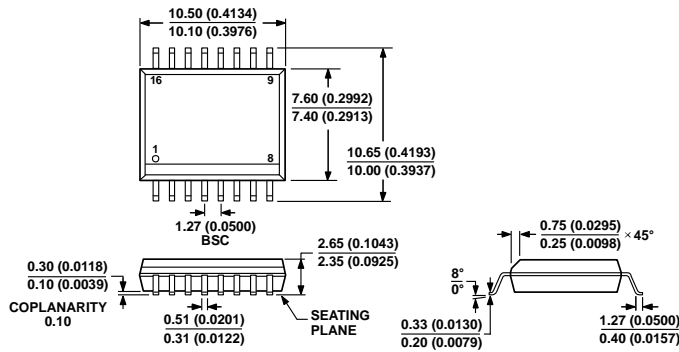

Figure 18. DC Waveform

OUTLINE DIMENSIONS



COMPLIANT TO JEDEC STANDARDS MS-013-AA
 CONTROLLING DIMENSIONS ARE IN MILLIMETERS; INCH DIMENSIONS
 (IN PARENTHESES) ARE ROUNDED-OFF MILLIMETER EQUIVALENTS FOR
 REFERENCE ONLY AND ARE NOT APPROPRIATE FOR USE IN DESIGN.

Figure 19. 16-Lead Standard Small Outline Package [SOIC_W]
 Wide Body
 (RW-16)

Dimensions shown in millimeters and (inches)

00-27-2807-B

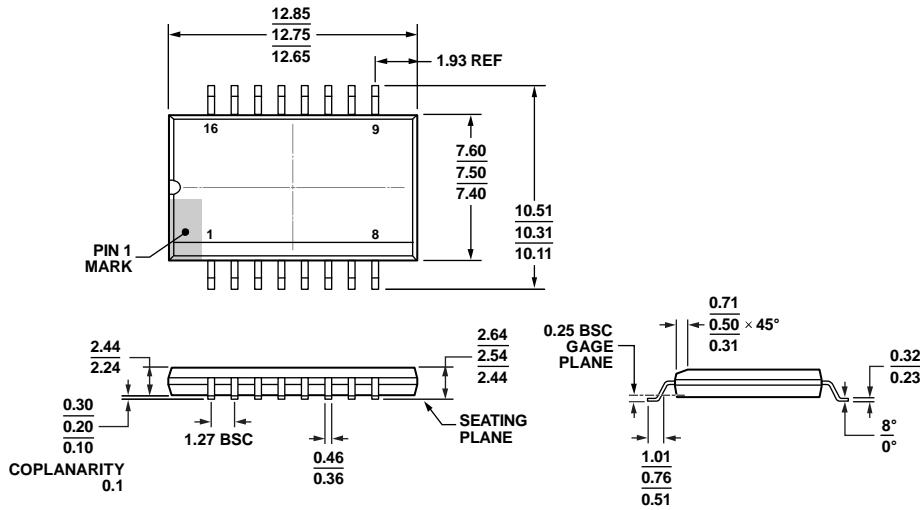

COMPLIANT TO JEDEC STANDARDS MS-013-AC
 Figure 20. 16-Lead Standard Small Outline Package, with Increased Creepage [SOIC_IC]
 Wide Body
 (RI-16-2)
 Dimensions shown in millimeters

11-15-2011-A

ORDERING GUIDE

Model ^{1, 2, 3}	Number of Inputs, V _{DD1} Side	Number of Inputs, V _{DD2} Side	Maximum Data Rate (Mbps)	Maximum Propagation Delay, 5 V (ns)	Maximum Pulse Width Distortion (ns)	Temperature Range	Package Description	Package Option
ADuM2210SRIZ	2	0	1	150	40	−40°C to +125°C	16-Lead SOIC_IC	RI-16-2
ADuM2210SRWZ	2	0	1	150	40	−40°C to +125°C	16-Lead SOIC_W	RW-16
ADuM2210WSRWZ	2	0	1	150	40	−40°C to +125°C	16-Lead SOIC_W	RW-16
ADuM2210TRIZ	2	0	10	50	3	−40°C to +125°C	16-Lead SOIC_IC	RI-16-2
ADuM2210TRWZ	2	0	10	50	3	−40°C to +125°C	16-Lead SOIC_W	RW-16
ADuM2210WTRWZ	2	0	10	50	3	−40°C to +125°C	16-Lead SOIC_W	RW-16
ADuM2211SRIZ	1	1	1	150	40	−40°C to +125°C	16-Lead SOIC_IC	RI-16-2
ADuM2211SRWZ	1	1	1	150	40	−40°C to +125°C	16-Lead SOIC_W	RW-16
ADuM2211WSRWZ	1	1	1	150	40	−40°C to +125°C	16-Lead SOIC_W	RW-16
ADuM2211TRWZ	1	1	10	50	3	−40°C to +125°C	16-Lead SOIC_W	RW-16
ADuM2211WTRWZ	1	1	10	50	3	−40°C to +125°C	16-Lead SOIC_W	RW-16
ADuM2211TRIZ	1	1	10	50	3	−40°C to +125°C	16-Lead SOIC_IC	RI-16-2

¹ Z = RoHS Compliant Part.

² Tape and reel is available. The addition of an -RL suffix designates a 13" (1,000 units) tape and reel option.

³ W = Qualified for Automotive Applications.

AUTOMOTIVE PRODUCTS

The [ADuM2210W/ADuM2211W](#) models are available with controlled manufacturing to support the quality and reliability requirements of automotive applications. Note that these automotive models may have specifications that differ from the commercial models; therefore, designers should review the Specifications section of this data sheet carefully. Only the automotive grade products shown are available for use in automotive applications. Contact your local Analog Devices account representative for specific product ordering information and to obtain the specific Automotive Reliability reports for these models.

Компания «Life Electronics» занимается поставками электронных компонентов импортного и отечественного производства от производителей и со складов крупных дистрибьюторов Европы, Америки и Азии.

С конца 2013 года компания активно расширяет линейку поставок компонентов по направлению коаксиальный кабель, кварцевые генераторы и конденсаторы (керамические, пленочные, электролитические), за счёт заключения дистрибьюторских договоров

Мы предлагаем:

- Конкурентоспособные цены и скидки постоянным клиентам.
- Специальные условия для постоянных клиентов.
- Подбор аналогов.
- Поставку компонентов в любых объемах, удовлетворяющих вашим потребностям.
- Приемлемые сроки поставки, возможна ускоренная поставка.
- Доставку товара в любую точку России и стран СНГ.
- Комплексную поставку.
- Работу по проектам и поставку образцов.
- Формирование склада под заказчика.
- Сертификаты соответствия на поставляемую продукцию (по желанию клиента).
- Тестирование поставляемой продукции.
- Поставку компонентов, требующих военную и космическую приемку.
- Входной контроль качества.
- Наличие сертификата ISO.

В составе нашей компании организован Конструкторский отдел, призванный помогать разработчикам, и инженерам.

Конструкторский отдел помогает осуществить:

- Регистрацию проекта у производителя компонентов.
- Техническую поддержку проекта.
- Защиту от снятия компонента с производства.
- Оценку стоимости проекта по компонентам.
- Изготовление тестовой платы монтаж и пусконаладочные работы.



Тел: +7 (812) 336 43 04 (многоканальный)
Email: org@lifeelectronics.ru