

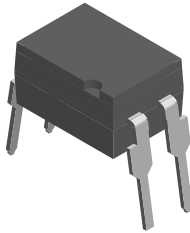

## Optocoupler, Phototransistor Output, High Reliability, 5300 V<sub>RMS</sub>

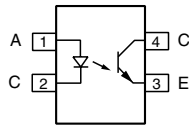

1179060



### DESCRIPTION

The SFH615XXX features a large assortment of current transfer ratio, low coupling capacitance and high isolation voltage. These couplers have a GaAs infrared emitting diode emitter, which is optically coupled to a silicon planar phototransistor detector, and is incorporated in a plastic DIP-4 package.

The coupling devices are designed for signal transmission between two electrically separated circuits.

The couplers are end-stackable with 2.54 mm lead spacing. Creepage and clearance distances of > 8 mm are achieved with option 6. This version complies with 60950 (DIN VDE 0805) for reinforced insulation up to operation voltage of 400 V<sub>RMS</sub> or DC.

### FEATURES

- Low CTR degradation
- Good CTR linearity depending on forward current
- Isolation test voltage, 5300 V<sub>RMS</sub>
- High collector emitter voltage, V<sub>CEO</sub> = 70 V
- Low saturation voltage
- Fast switching times
- Temperature stable
- Low coupling capacitance
- End stackable, 0.100" (2.54 mm) spacing
- High common mode interference immunity (unconnected base)
- Lead (Pb)-free component
- Component in accordance to RoHS 2002/95/EC and WEEE 2002/96/EC



RoHS COMPLIANT

### AGENCY APPROVALS

- UL1577, file no. E52744 system code H or J, double protection
- DIN EN 60747-5-2 (VDE 0884)/DIN EN 60747-5-5 pending available with option 1
- BSI IEC 60950; IEC 60065

| ORDER INFORMATION |  |
|-------------------|--|
| PART              | REMARKS                                    |
| SFH615AA          | CTR 50 to 600 %, DIP-4                     |
| SFH615AB          | CTR 80 to 260 %, DIP-4                     |
| SFH615ABL         | CTR 200 to 600 %, DIP-4                    |
| SFH615ABM         | CTR 200 to 400 %, DIP-4                    |
| SFH615AGB         | CTR 100 to 600 %, DIP-4                    |
| SFH615AGR         | CTR 100 to 300 %, DIP-4                    |
| SFH615AY          | CTR 50 to 150 %, DIP-4                     |
| SFH615AA-X006     | CTR 50 to 600 %, DIP-4 400 mil (option 6)  |
| SFH615AA-X007     | CTR 50 to 600 %, SMD-4 (option 7)          |
| SFH615ABM-X006    | CTR 200 to 400 %, DIP-4 400 mil (option 6) |
| SFH615ABM-X007    | CTR 200 to 400 %, SMD-4 (option 7)         |
| SFH615AGB-X006    | CTR 100 to 600 %, DIP-4 400 mil (option 6) |
| SFH615AGB-X009    | CTR 100 to 600 %, SMD-4 (option 9)         |
| SFH615AGR-X006    | CTR 100 to 300 %, DIP-4 400 mil (option 6) |
| SFH615AGR-X007    | CTR 100 to 300 %, SMD-4 (option 7)         |
| SFH615AY-X006     | CTR 50 to 150 %, DIP-4 400 mil (option 6)  |
| SFH615AY-X008     | CTR 50 to 150 %, SMD-4 (option 8)          |
| SFH615AY-X009     | CTR 50 to 150 %, SMD-4 (option 9)          |

### Note

For additional information on the available options refer to option information.

# SFH615AA/AGB/AGR/ABM/ABL/AY/AB



Vishay Semiconductors Optocoupler, Phototransistor Output,  
High Reliability, 5300 V<sub>RMS</sub>

| ABSOLUTE MAXIMUM RATINGS (1)   |   |                   |                    |                  |
|--|---|-------------------|--------------------|------------------|
| PARAMETER  | TEST CONDITION  | SYMBOL            | VALUE              | UNIT             |
| <b>INPUT</b>   |   |                   |                    |                  |
| Reverse voltage  |   | V <sub>R</sub>    | 6.0                | V                |
| DC forward current   |   | I <sub>F</sub>    | 60                 | mA               |
| Surge forward current  | t <sub>p</sub> ≤ 10 ms                                      | I <sub>FSM</sub>  | 2.5                | A                |
| Power dissipation  |   | P <sub>diss</sub> | 100                | mW               |
| <b>OUTPUT</b>  |   |                   |                    |                  |
| Collector emitter voltage  |   | V <sub>CE</sub>   | 70                 | V                |
| Emitter collector voltage  |   | V <sub>EC</sub>   | 7.0                | V                |
| Collector current  |   | I <sub>C</sub>    | 50                 | mA               |
|  | t <sub>p</sub> ≤ 10 ms                                      | I <sub>C</sub>    | 100                | mA               |
| Total power dissipation  |   | P <sub>diss</sub> | 150                | mW               |
| <b>COUPLER</b>   |   |                   |                    |                  |
| Isolation test voltage between emitter and detector, refer to climate DIN 40046, part 2, Nov. 74             |   | V <sub>ISO</sub>  | 5300               | V <sub>RMS</sub> |
| Creepage distance  |   |                   | ≥ 7                | mm               |
| Clearance distance   |   |                   | ≥ 7                | mm               |
| Isolation thickness between emitter and detector Comparative tracking index per DIN IEC 112/VDE 0303, part 1 |   | CTI               | ≥ 175              |                  |
| Isolation resistance   | V <sub>IO</sub> = 500 V, T <sub>amb</sub> = 25 °C           | R <sub>IO</sub>   | ≥ 10 <sup>12</sup> | Ω                |
|  | V <sub>IO</sub> = 500 V, T <sub>amb</sub> = 100 °C          | R <sub>IO</sub>   | ≥ 10 <sup>11</sup> | Ω                |
| Storage temperature range  |   | T <sub>stg</sub>  | - 55 to + 150      | °C               |
| Ambient temperature range  |   | T <sub>amb</sub>  | - 55 to + 100      | °C               |
| Soldering temperature (2)  | max. 10 s, dip soldering distance to seating plane ≥ 1.5 mm | T <sub>sld</sub>  | 260                | °C               |

## Notes

(1) T<sub>amb</sub> = 25 °C, unless otherwise specified.

Stresses in excess of the absolute maximum ratings can cause permanent damage to the device. Functional operation of the device is not implied at these or any other conditions in excess of those given in the operational sections of this document. Exposure to absolute maximum ratings for extended periods of the time can adversely affect reliability.

(2) Refer to reflow profile for soldering conditions for surface mounted devices (SMD). Refer to wave profile for soldering conditions for through hole devices (DIP).

| ELECTRICAL CHARACTERISTICS    |                                      |      |                   |      |      |      |      |
|-------------------------------|--------------------------------------|------|-------------------|------|------|------|------|
| PARAMETER                     | TEST CONDITION                       | PART | SYMBOL            | MIN. | TYP. | MAX. | UNIT |
| <b>INPUT</b>                  |                                      |      |                   |      |      |      |      |
| Forward voltage               | I <sub>F</sub> = 60 mA               |      | V <sub>F</sub>    |      | 1.25 | 1.65 | V    |
| Reverse current               | V <sub>R</sub> = 6.0 V               |      | I <sub>R</sub>    |      | 0.01 | 10   | μA   |
| Capacitance                   | V <sub>R</sub> = 0 V, f = 1.0 MHz    |      | C <sub>O</sub>    |      | 13   |      | pF   |
| Thermal resistance            |                                      |      | R <sub>thja</sub> |      | 750  |      | K/W  |
| <b>OUTPUT</b>                 |                                      |      |                   |      |      |      |      |
| Collector emitter capacitance | V <sub>CE</sub> = 5.0 V, f = 1.0 MHz |      | C <sub>CCE</sub>  |      | 5.2  |      | pF   |
| Thermal resistance            |                                      |      | R <sub>thja</sub> |      | 500  |      | K/W  |



# SFH615AA/AGB/AGR/ABM/ABL/AY/AB

Optocoupler, Phototransistor Output, Vishay Semiconductors  
High Reliability, 5300 V<sub>RMS</sub>

| ELECTRICAL CHARACTERISTICS           |  |           |             |      |      |      |      |
|--------------------------------------|--|-----------|-------------|------|------|------|------|
| PARAMETER                            | TEST CONDITION                                 | PART      | SYMBOL      | MIN. | TYP. | MAX. | UNIT |
| <b>COUPLER</b>                       |  |           |             |      |      |      |      |
| Collector emitter saturation voltage | $I_F = 10 \text{ mA}$ , $I_C = 2.5 \text{ mA}$ |           | $V_{CEsat}$ |      | 0.25 | 0.4  | V    |
| Coupling capacitance                 |  |           | $C_C$       |      | 0.4  |      | pF   |
| Collector emitter leakage current    | $V_{CEO} = 10 \text{ V}$                       | SFH615AA  | $I_{CEO}$   |      | 10   | 100  | nA   |
|                                      |  | SFH615AGB | $I_{CEO}$   |      | 10   | 100  | nA   |
|                                      |  | SFH615AGR | $I_{CEO}$   |      | 10   | 100  | nA   |
|                                      |  | SFH615ABM | $I_{CEO}$   |      | 10   | 100  | nA   |
|                                      |  | SFH615ABL | $I_{CEO}$   |      | 10   | 100  | nA   |
|                                      |  | SFH615AY  | $I_{CEO}$   |      | 10   | 100  | nA   |
|                                      |  | SFH615AB  | $I_{CEO}$   |      | 10   | 100  | nA   |

**Note**

$T_{amb} = 25 \text{ }^\circ\text{C}$ , unless otherwise specified.

Minimum and maximum values are testing requirements. Typical values are characteristics of the device and are the result of engineering evaluation. Typical values are for information only and are not part of the testing requirements.

| CURRENT TRANSFER RATIO |   |           |        |      |      |      |      |
|------------------------|---|-----------|--------|------|------|------|------|
| PARAMETER              | TEST CONDITION                                    | PART      | SYMBOL | MIN. | TYP. | MAX. | UNIT |
| $I_C/I_F$              | $I_F = 5.0 \text{ mA}$ , $V_{CE} = 5.0 \text{ V}$ | SFH615AA  | CTR    | 50   |      | 600  | %    |
|                        |   | SFH615AGB | CTR    | 100  |      | 600  | %    |
|                        |   | SFH615AGR | CTR    | 100  |      | 300  | %    |
|                        |   | SFH615ABM | CTR    | 200  |      | 400  | %    |
|                        |   | SFH615ABL | CTR    | 200  |      | 600  | %    |
|                        |   | SFH615AY  | CTR    | 50   |      | 150  | %    |
|                        |   | SFH615AB  | CTR    | 80   |      | 260  | %    |

| SWITCHING CHARACTERISTICS |                        |           |      |      |      |               |  |
|---------------------------|------------------------|-----------|------|------|------|---------------|--|
| PARAMETER                 | TEST CONDITION         | SYMBOL    | MIN. | TYP. | MAX. | UNIT          |  |
| Turn-on time              | $I_F = 5.0 \text{ mA}$ | $t_{on}$  |      | 2.0  |      | $\mu\text{s}$ |  |
| Turn-off time             | $I_F = 5.0 \text{ mA}$ | $t_{off}$ |      | 25   |      | $\mu\text{s}$ |  |

**TYPICAL CHARACTERISTICS**

$T_{amb} = 25 \text{ }^\circ\text{C}$ , unless otherwise specified

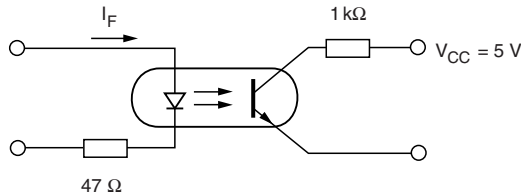

isfh615aa\_01

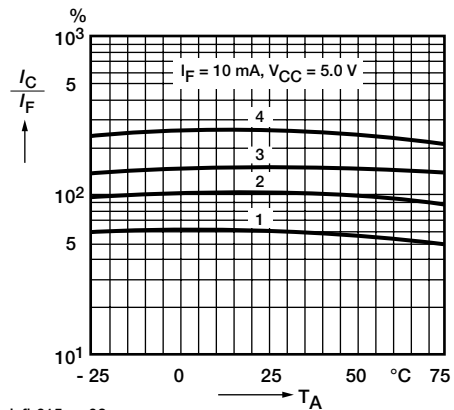

isfh615aa\_02

Fig. 1 - Switching Operation (With Saturation)

Fig. 2 - Current Transfer Ratio (Typical) vs. Temperature

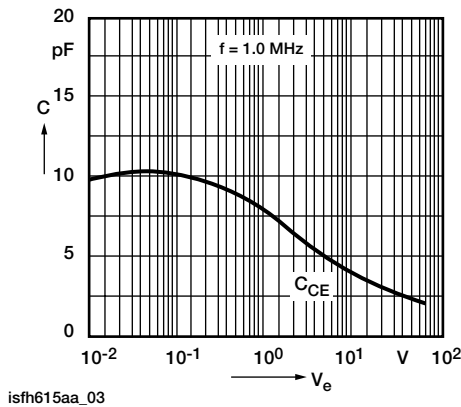

Fig. 3 - Transistor Capacitance (Typ.) vs. Collector Emitter Voltage

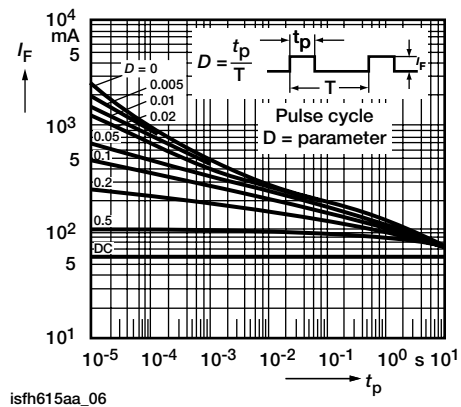

Fig. 6 - Permissible Pulse Handling Capability Forward Current vs. Pulse Width

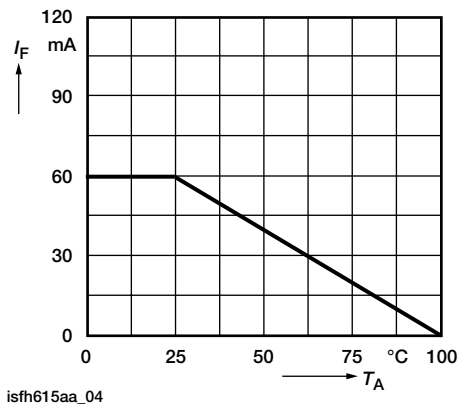

Fig. 4 - Permissible Diode Forward Current vs. Ambient Temperature

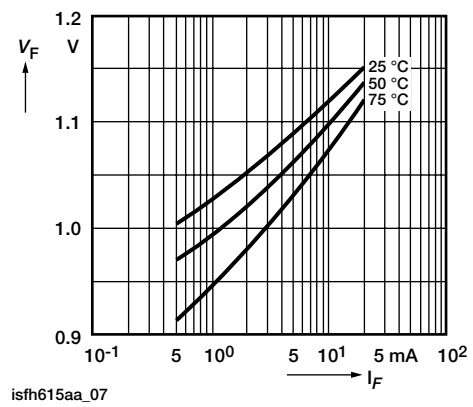

Fig. 7 - Diode Forward Voltage (Typ.) vs. Forward Current

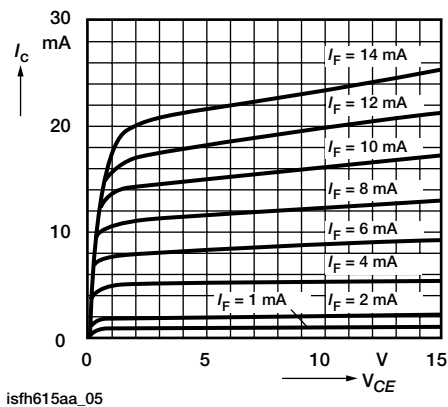

Fig. 5 - Output Characteristics (Typ.) Collector Current vs. Collector Emitter Voltage

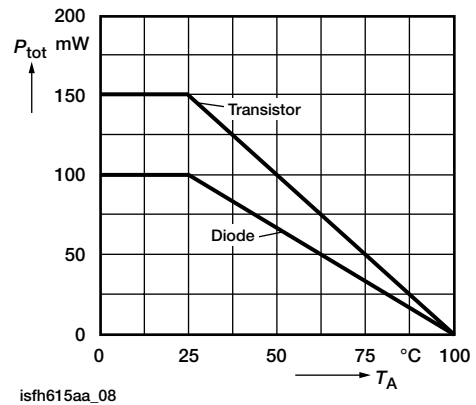

Fig. 8 - Permissible Power Dissipation vs. Temperature



# SFH615AA/AGB/AGR/ABM/ABL/AY/AB

Optocoupler, Phototransistor Output, Vishay Semiconductors  
High Reliability, 5300 V<sub>RMS</sub>

## PACKAGE DIMENSIONS in inches (millimeters)

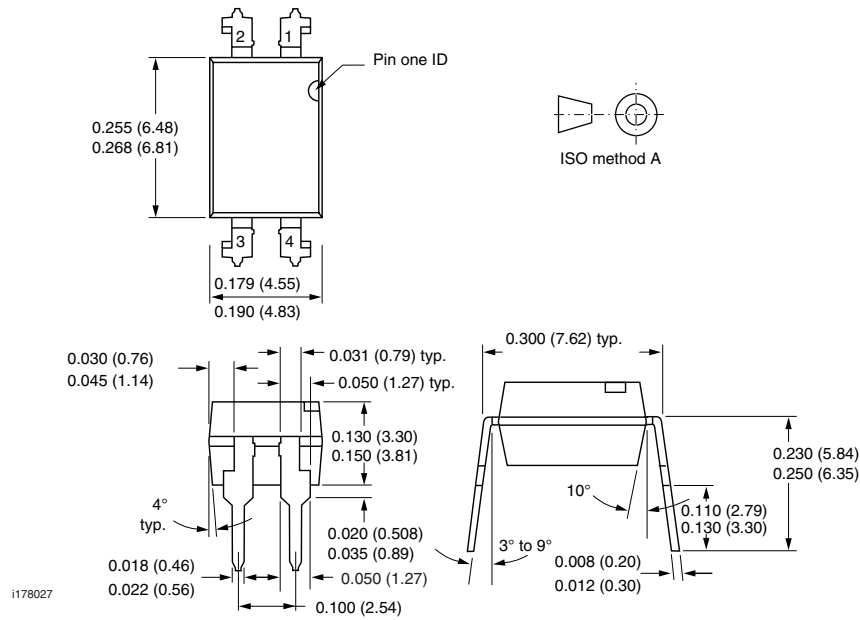



## **OZONE DEPLETING SUBSTANCES POLICY STATEMENT**

It is the policy of Vishay Semiconductor GmbH to

1. Meet all present and future national and international statutory requirements.
2. Regularly and continuously improve the performance of our products, processes, distribution and operating systems with respect to their impact on the health and safety of our employees and the public, as well as their impact on the environment.

It is particular concern to control or eliminate releases of those substances into the atmosphere which are known as ozone depleting substances (ODSs).

The Montreal Protocol (1987) and its London Amendments (1990) intend to severely restrict the use of ODSs and forbid their use within the next ten years. Various national and international initiatives are pressing for an earlier ban on these substances.

Vishay Semiconductor GmbH has been able to use its policy of continuous improvements to eliminate the use of ODSs listed in the following documents.

1. Annex A, B and list of transitional substances of the Montreal Protocol and the London Amendments respectively.
2. Class I and II ozone depleting substances in the Clean Air Act Amendments of 1990 by the Environmental Protection Agency (EPA) in the USA.
3. Council Decision 88/540/EEC and 91/690/EEC Annex A, B and C (transitional substances) respectively.

Vishay Semiconductor GmbH can certify that our semiconductors are not manufactured with ozone depleting substances and do not contain such substances.

We reserve the right to make changes to improve technical design  
and may do so without further notice.

Parameters can vary in different applications. All operating parameters must be validated for each customer application by the customer. Should the buyer use Vishay Semiconductors products for any unintended or unauthorized application, the buyer shall indemnify Vishay Semiconductors against all claims, costs, damages, and expenses, arising out of, directly or indirectly, any claim of personal damage, injury or death associated with such unintended or unauthorized use.

Vishay Semiconductor GmbH, P.O.B. 3535, D-74025 Heilbronn, Germany



## Notice

Specifications of the products displayed herein are subject to change without notice. Vishay Intertechnology, Inc., or anyone on its behalf, assumes no responsibility or liability for any errors or inaccuracies.

Information contained herein is intended to provide a product description only. No license, express or implied, by estoppel or otherwise, to any intellectual property rights is granted by this document. Except as provided in Vishay's terms and conditions of sale for such products, Vishay assumes no liability whatsoever, and disclaims any express or implied warranty, relating to sale and/or use of Vishay products including liability or warranties relating to fitness for a particular purpose, merchantability, or infringement of any patent, copyright, or other intellectual property right.

The products shown herein are not designed for use in medical, life-saving, or life-sustaining applications. Customers using or selling these products for use in such applications do so at their own risk and agree to fully indemnify Vishay for any damages resulting from such improper use or sale.

Компания «Life Electronics» занимается поставками электронных компонентов импортного и отечественного производства от производителей и со складов крупных дистрибьюторов Европы, Америки и Азии.

С конца 2013 года компания активно расширяет линейку поставок компонентов по направлению коаксиальный кабель, кварцевые генераторы и конденсаторы (керамические, пленочные, электролитические), за счёт заключения дистрибьюторских договоров

Мы предлагаем:

- Конкурентоспособные цены и скидки постоянным клиентам.
- Специальные условия для постоянных клиентов.
- Подбор аналогов.
- Поставку компонентов в любых объемах, удовлетворяющих вашим потребностям.
- Приемлемые сроки поставки, возможна ускоренная поставка.
- Доставку товара в любую точку России и стран СНГ.
- Комплексную поставку.
- Работу по проектам и поставку образцов.
- Формирование склада под заказчика.
- Сертификаты соответствия на поставляемую продукцию (по желанию клиента).
- Тестирование поставляемой продукции.
- Поставку компонентов, требующих военную и космическую приемку.
- Входной контроль качества.
- Наличие сертификата ISO.

В составе нашей компании организован Конструкторский отдел, призванный помогать разработчикам, и инженерам.

Конструкторский отдел помогает осуществить:

- Регистрацию проекта у производителя компонентов.
- Техническую поддержку проекта.
- Защиту от снятия компонента с производства.
- Оценку стоимости проекта по компонентам.
- Изготовление тестовой платы монтаж и пусконаладочные работы.



Тел: +7 (812) 336 43 04 (многоканальный)

Email: [org@lifeelectronics.ru](mailto:org@lifeelectronics.ru)