

LedLink

Contents



■ Linking LEDs to the real world ■

■ Linking LEDs to the real world ■

CREE

XBD	59
XPE/XPE2	60
XPG/XPG2	62
MX3/ MX6	63
XTE	64
XML/ XML2	65
XML EZW	66
MKR	66
MTG/ MTG2	66
CXA1304/15xx	67
CXA1816/ 25xx	68
CXA3050	68

PHILIPS LUMILEDS

LHCI 1203/1204	69
1205/1208	69
Rebel	70
Rebel Es	71
Luxeon T	72
Luxeon M/S	73

OSRAM Opto Semiconductors

Oslon 80°	74
Oslon 150°	75
Oslon Square	76
Ostar/ W5AM	77

NICHIA

NVS19A	78
NCS19A	79
NVS19B	80
383/757A	81
183A	82
NSBLL 036	82
NSBLL 066	82
NSBLL 121	82

CITIZEN Micro HumanTech

CLL010	83
CLL020	83
CLL030	83
CLL040/430	83

SHARP

Petite Zenigata	84
Mini Zenigata	84
Mega Zenigata	85

EDISON

1LA5	86
EdiPower II	
EPCX-HR96	87
EPSX-HRB8	87
EPSX-HRBF	87
EPSX-HRBJ	87
Federal 3535	88

SAMSUNG SAMSUNG LED

LH351A	89
--------	----

SEOUL

P4	90
Z5	91

LG Innotek Ceramic 3535 92

About Ledlink



Ledlink Optics, Inc. was founded in April 2008, specializing in optical, structure and precise manufacturing from a professional background. We've successfully developed all kinds of optical lenses with variety of angles, beam patterns and blend lights.

Our mission is to assist customers achieve the full and complete use of LED light source applications, and reaching the highest performance as well as changing the beam patterns and angles in order to adapt to different requirements of applications.

Ledlink Optics, Inc. provides the total solutions of secondary optics to enhance the lighting value of LED, and leading our customers on the cutting edge of lighting industry.

2009.05
ISO 9001, ISO14001
Certification approved

2009.12
Dong-Guan secondary
factory established

2011.03
Third factory expansion
in Dong-Guan
Yang-Zhou Ledlink
construction

2011.05
Listed in Emerging Market

2011.09
TS16949 Certification approved



2011.12
Awarded the 16th place of Deloitte
Technology Fast500 Asia Pacific 2011

Deloitte.
Technology Fast500

2008-2009

2010-2011

2012-2013



2008.03
Ledlink established in Taipei



2008.08
Dong-Guan factory
established



2010.01
UL Certification approved

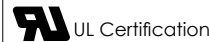

2010.09
Sign Yang-Zhou Ledlink
investment agreement

2012.06
IPO in OTC



2013.08
Yangzhou factory mass
production

Secondary Optical Lens

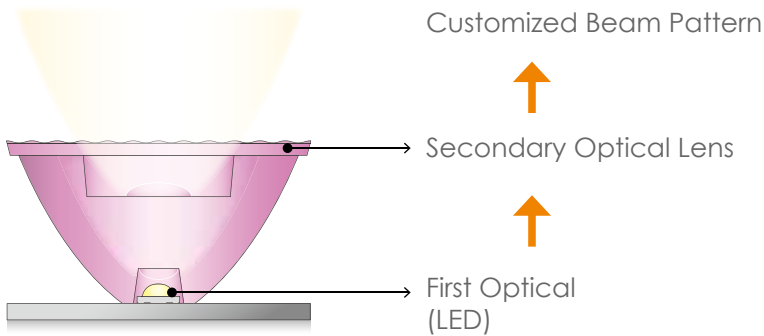

Generally speaking, LED need to proceed secondary optics design prior to become lamp fixture, LED package is first optics design and secondary optics design is that we change the optical character from the light of first optics through secondary optical change.

Name	Symbol	Unit	Description
Luminous Flux	Φ	Lm(Lumen)	Light source shot in total amount per second
Illuminance	E	lm/m ² (Lux)	<p>Illuminance means in one lighted area, the density of the luminous flux on a surface, per unit area.(Illuminance is inverse ratio to the square of distance from one illuminant. And it expresses the brightness of one place.)</p> $\text{Illuminance}(E) = \frac{\text{Luminous Flux}(\Phi)}{\text{Area}(A)}$
Luminous Intensity	I	Cd(Candela)	<p>The Luminous Flux in certain direction of light source of solid angle(Ω)</p> $\text{Luminous Intensity}(I) = \frac{\text{Luminous Flux}(\Phi)}{\text{Solid angle}(\Omega)}$
Luminance	L	cd/m ²	<p>Luminance means the luminous intensity(I) per unit of one illuminated area which light radiates or passes through in a given direction.</p> $\text{Luminance}(L) = \frac{\text{Luminous Intensity}(I)}{\text{Area}(A)}$

Definition of Beam Angle

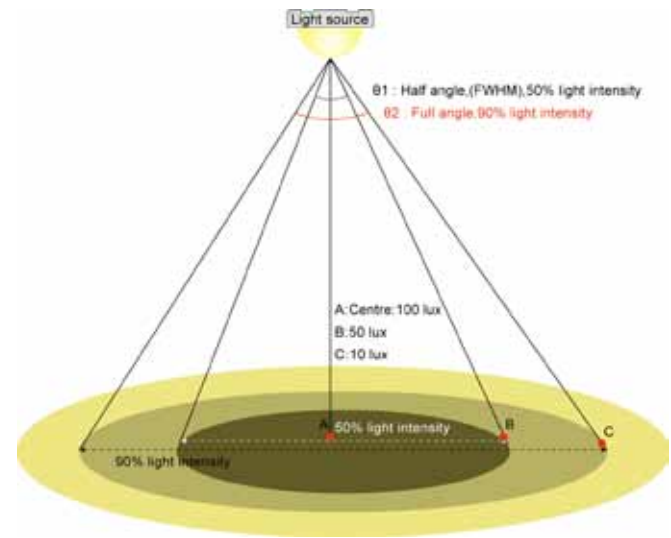
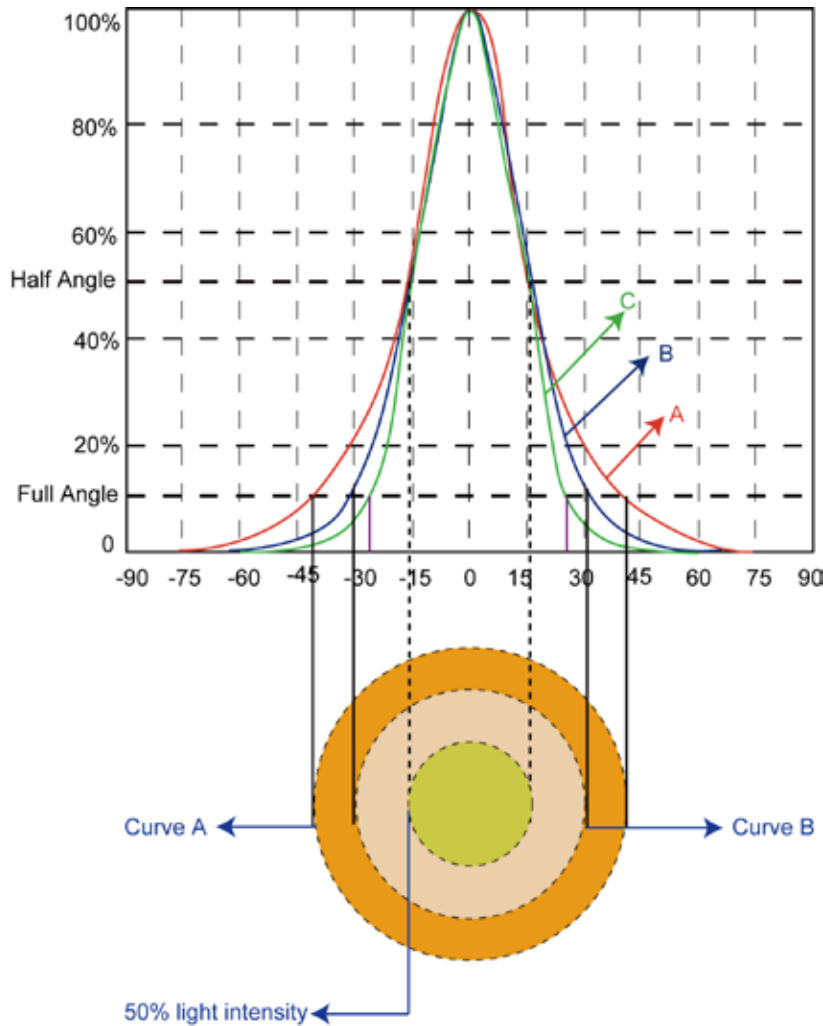

Half angle: 50% light intensity (FWHM)
 Full angle: 10% light intensity
 For Curve A, B, and C → half angle 30°
 Full angle : Curve A = 80°
 Curve B = 60°
 Curve C = 50°

Full angle definition is more accurate as it allows the luminaries designer to arrange/ develop their LED lamp.

Street Lighting

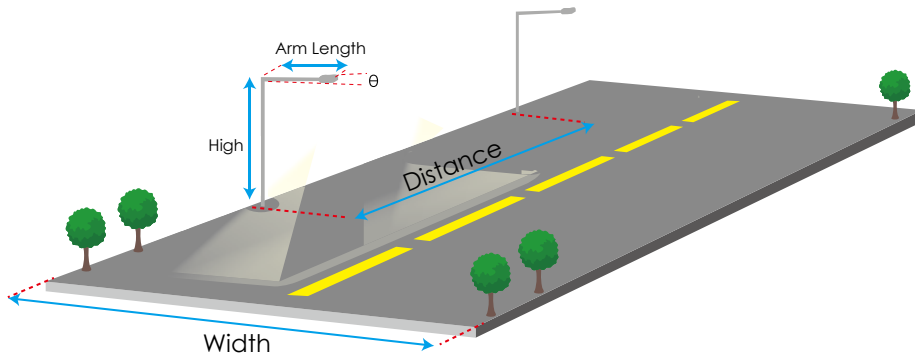

LED requirements:

- LED brand/ type
- MCPCB layout (arrangement)
- MCPCB 2D drawing; LED position is critical

Mechanical requirements:

- Dimension limitations:
- Mounting method: Screw/ Thermal mount/ Glue
- Waterproof: Rubber ring height/ Silicon

Installation conditions:

- Pole Arrangement
- Pole Height (H)
- Pole Distance (D)
- Pole tilt angle (θ)
- Pole arm length (L)
- Road Width: (W)
- Optical requirements

Optical requirements

- Uniformity
- Min lux
- Avg lux
- Cd / m²(U_o / U_I / T_I)
- Type1~Type5

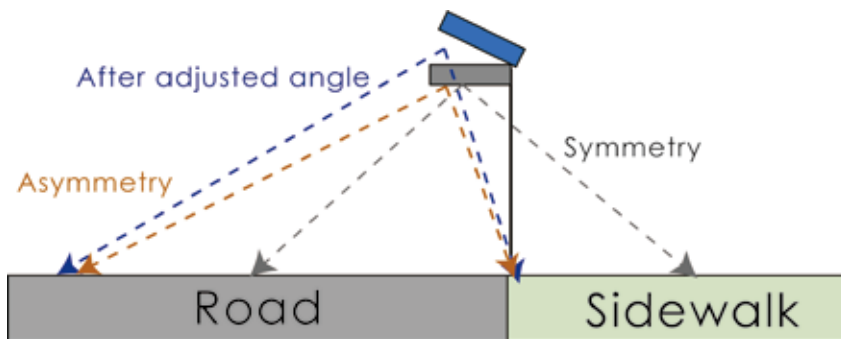

The asymmetry street lighting lens designed by Ledlink Optics Inc. is aiming to focus light and make the asymmetric beam pattern. Because of the lens, light can be focused and used upon customer's demand. The optics lens reduce spill light from arcade and redirect light to the street resulting in increased several times of luminance intensity and illumination brightness. Thus, a secondary optical lens is a way to save energy cost and LED requested amount, as well as it can maximize LED performance.

Product Nomenclature

L L 01 CR - AO x x L - M x

X1 X2 X3 X4 X5 X6 X7
Lens Item Lens Q'ty Led Type Serial Number Lens Angle Type Housing

X1: Lens Item → Ledlink

X2: Lens Q'ty → 01, 03, 04, 06, 07, 09, 12, 15, 18, 24, 36, 60

X3: Led Type : CR → Cree
ED → Edison
LU → Lumileds
NI → Nichia
OS → Osram

X4: Serial Number → AA, AB, AC,Ex,.....

X5: Lens Angle → 08°, 10°, 15°, 25°,.....,40°,.....,80°,.....,140°,25°x45°,30°x65°...

**X6: Type : L → Lens(Material:L02-PC, L06-PMMA)
R→Reflector(Material:R35-Plastic Plating, R49-Aluminum)**

X7: Housing : M1 → Black
M2 → White
M3 → Clear



▶ Single/COB Lens



▶ Reflector



▶ Multi Lens













▶ Convex Lens

LENS Series

Single Lens



DXH (mm)	Part Number	Degree	LED	Picture
10 x 6	LL01OS-HGxxL06	Full angle: 40° 60°	Osram Oslon SSL 80	
13.5 x 7.35	LL01CR-DFxxL06-M2 (Tape available)	Full angle: 25° 40° 60° 80° 100° 30°x65°	Cree XP-E2, XP-G2 Nichia NCS19, NVS19, NVS19B	
13.5 x 7.35	LL01LU-DFxxL06-M2 (Tape available)	Full angle: 80° 100° 30°x65°	Lumileds Rebel, Rebel ES	
13.5 x 7.35	LL01CR-BDFxxL06-M2 (Tape available)	Full angle: 40° 60°	Cree XB-D	
13.5 x 7.35	LL01CR-AAFxxL02-M2 (Tape available)	FWHM: 25° 45° 60°	Cree XP-E2, XP-G2 Nichia NCS19, NVS19, NVS19B LGIT Ceramic 3535	
13.5 x 7.35	LL01HS-AAFxxL02-M2 (Tape available)	FWHM: 25° 45° FWHM: 25° 45° 60°	Cree XP-E2, XP-G2 Nichia NCS19, NVS19, NVS19B LGIT Ceramic 3535	
13.5 x 7.35	LL01OS-AAFxxL02-M2 (Tape available)	FWHM: 25° 45° 60°	Nichia 757A	
13.5 x 7.35	LL01OS-BDFxxL06-M2 (Tape available)	Full angle: 40° 60° 80° 100°	Cree XP-E2, XP-G2 Nichia NCS19, NVS19, NVS19B LGIT Ceramic 3535	
16 x 10.3	LL01CR-HQxxL06-M2	Full angle: 15° 25° 30° 40° 60° 80° 25°x45°	Cree XP-E, XP-G	
16.6 x 10.45	LL01CR-OTxxL06-M2	Full angle: 40° 60° 80°	Cree XP-E2, XP-G2, XT-E Edison Federal 3535(1BE7) Osram Oslon SSL 80 / Square	
19.65 x 12.1	LL01OS-DSxxL06	Full angle: 15° 30°	Osram W5AM	

DXH (mm)	Part Number	Degree	LED	Picture
19.7 x 11.9	LL01ED-BJ38L06	Full angle: 38°	Edison 1LA5	
19.9 x 10.55	LL01ED-FM38L06	Full angle: 38°	Cree XP-E2, XP-G2, XB-D, MX-3/6 Edison 1LA5, Federal 3045/3535(1BE1) Lgit Ceramic 3535 V2 Lumileds Rebel, Luxeon T Nichia NVS19B Osram Oslon SSL 80/150, Oslon Square Seoul A4, P4	
20 x 11.5	LL01OS-LA20L02	Full angle: 20°	Cree XP-E	
20 x 18.5	LL01CR-ADI10L06	FWHM: 10°	Cree XP-E	
20.8 x 12.35	LL01OS-BFVxxL06	FWHM: 15° 25° 30° 15°x40°	Cree XP-E, XP-E2, XP-G, XP-G2, XT-E, XB-D Osram Oslon SSL 80	
21 x 12.6	LL01CR-AA2065L06-M2	Full angle: 20° x 65°	Cree XP-E	
21 x 13.9	LL01CR-SQxxL06-M2 (Tape available)	Full angle: 40° 60° 80°	Cree XM-L Edison Federal 5050	
21 x 13.9	LL01CR-YJxxL02-M2 (Tape available)	Full angle: 40° 60° 80° 100°	Cree XM-L Edison Federal 5050	
21.05 x 14.75	LL01OS-MQxxL06-M2	Full angle: 15° 25° 40° 60°	Osram Oslon SSL 80 / Square	
21.2 x 15.1	LL01ED-CVxxL06-M2	Full angle: 15° 25° 45°	Edison 1LA5	













20 mm
|
21 mm



21 mm
|
22 mm

DXH (mm)	Part Number	Degree	LED	Picture
21.3 x 12.4	LL01LU-AFCxxL06-M2 (Tape available)	FWHM: 10° 15° 25° 30° 10°x35° 15°x30°	Lumileds Rebel, Rebel ES	
21.3 x 12.4	LL01OS-AFCxxL06-M2 (Tape available)	FWHM: 10° 15° 25° 30° 10°x35° 15°x30°	Osram Oslon SSL 80 / Square	
21.3 x 12.4	LL01CR-AFCxxL06-M2 (Tape available)	FWHM: 10° 15° 25° 30° 10°x35° 15°x30°	Cree XP-E2, XP-G2	
21.3 x 14	LL01ED-AHxxL06-M2	Full angle: 30° 45° 60°	Edison 1LA5	
21.3 x 14	LL01ED-ALxxL06-M2	Full angle: 15°	Edison 1LA5	
		Full angle: 30°x65°	Edison 1LA5 Seoul P4	
21.3 x 14	LL01ED-BLxxL06-M2	Full angle: 25°	Edison 1LA5	
21.3 x 14	LL01ED-BPxxL06-M2	Full angle: 45°	Edison 1LA5	
21.3 x 14	LL01ED-BSxxL06-M2	Full angle: 10° 38° 60°	Edison 1LA5	
21.3 x 14	LL01ED-BVxxL06-M2	Full angle: 60°	Edison 1LA5	
21.3 x 14	LL01ED-ZBxxL06-M1	Full angle: 15°	Edison 1LA5	
21.5 x 13.35	LL01OS-AXxxL02-M2	Full angle: 20° 40° 60°	Osram W5AM	









DXH (mm)	Part Number	Degree	LED	Picture
21.5 x 13.95	LL01CR-BRxxL06-M2	Full angle: 30° 40° 50° 10°x45° 15°x50° 15°x80° 40°x90°	Cree XRE	
21.5 x 15.0	LL01ED-CVxxL02-M2	Full angle: 15° 25° 45°	Edison 1LA5 RGB	
21.9 x 12.3	LL01ED-ASxxL06-M2	Full angle: 15° 38° 60°	Edison 1LA5	
21.9 x 12.3	LL01ED-AS38R06-M2	Full angle: 38°	Edison 1LA5	
22.2 x 10.6	LL01ZZ-AHZxxL02	FWHM: 24° 38°	Cree XM-L, XM-L EZW Lumileds Luxeon T	
22.4 x 9.63	LL01LU-LH15L06-M2	Full angle: 15°	Luxeon Rebel	
22.4 x 9.7	LL01ZZ-EXxxL06-M2 (Tape available)	Full angle: 10° 25° 40° 60° 110° 30° x 65°	Cree XP-E2, XP-G2	
22.4 x 9.7	LL01LU-EXxxL06-M2 (Tape available)	Full angle: 10° 25° 40° 60° 110° 30° x 65°	Lumileds Rebel, Rebel ES	
22.4 x 9.7	LL01OS-EXxxL06-M2 (Tape available)	Full angle: 10° 25° 40° 60° 110° 30° x 65°	Osram Oslon SSL 80 / Square	
22.4 x 9.7	LL01CR-BEXxxL06-M (Tape available)	Full angle: 25° 40° 60°	Cree XB-D Osram Oslon Square	
22.5 x 10.55	LL01ED-AQxxL06	Full angle: 15° 40° 60°	Edison Edixeon	











21 mm
|
23 mm

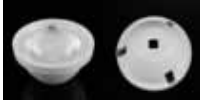

23 mm
|
25 mm













DXH (mm)	Part Number	Degree	LED	Picture
23.5 x 14.9	LL01NI-GRxxL06-M2	Full angle: 25° 40° 60° 80°	Nichia 183A	
23.5 x 15.8	LL01NI-ANExxL02-M2 (Tape available)	FWHM: 10° 20° 30° 55°	Nichia NCS19, NVS19, NVS19B	
23.5 x 15.8	LL01CR-BNExxL06-M2	Full angle: 25° 40° 60° 35°x70°	Cree XB-D	
23.5 x 15.8	LL01CR-CNExxL06-M2 (Tape available)	Full angle: 17° 25° 40° 60° 80° 10°x45° 25°x45°	Cree XP-E2, XP-G2, XT-E Edison Federal 3535(1BE7)	
23.5 x 15.9	LL01CR-AOxxL06-M2	Full angle: 60°	Cree XRE	
23.5 x 17.5	LL01ED-AOxxL06-M2	Full angle: 30° 40° 60° 80° 25°x45°	Edison 1LA5	
24.3 x 11.5	LL01ZZ-FLxxL06-M2 (Tape available)	Full angle: 10° 25° 40° 60° 30°x65°	Cree XP-E2, XP-G2, XM-L2 Nichia NVS19B LGIT Ceramic 3535	
24.3 x 11.5	LL01LU-FLxxL06-M2 (Tape available)	Full angle: 10° 25° 40° 60° 30°x65°	Lumileds Rebel, Rebel ES	
24.3 x 11.5	LL01CR-AFLxxL02-M2 (Tape available)	Full angle: 35° 50° 70°	Cree MK-R, MT-G Lumileds Luxeon M	
24.3 x 12.3	LL01LU-AFLxxL02-M2	FWHM: 35° 50° 70°	Cree MK-R Lumileds Luxeon M	
24.3 x 12.3	LL01CR-FLxxL06-M2	Full angle: 25° 40°	Cree MCE	

DXH (mm)	Part Number	Degree	LED	Picture
25 x 13	LL01NI-DZ2040L06-M2	Full angle: 20°x40°	Cree MX6 Nichia 183	
25 x 13.5	LL01ED-ANxxL06-M2	Full angle: 25° 15°x50°	Edison 1LA5	
25.6 x 10	LL01OS-CB15L06	Full angle: 15°	Cree XP-E, XP-E2, XP-G, XP-G2, XT-E, XM-L, XM-L2, XM-L EZW Edison 1LA5, ET-3535, Federal 5050(White) Lumileds Luxeon A, Luxeon R, Luxeon T Nichia NVS19A, NVS19B, 183A(3chip) Osram Oslon SSL 80/150, Oslon Square Lgit Ceramic 3535 V2 Seoul A4, P4	
26 x 15.5	LL01ED-AFDxxL06	Full angle: 15°	Cree MC-E Color, XM-L Color Edison Federal 5050 Color Osram Ostar SMD color	
		Full angle: 20°	Cree MC-E Color, XM-L Color, XM-L2 Edison Federal 5050 Color Lumileds Luxeon M / T Nichia NVS19B Osram Oslon Square, Ostar SMD color Seoul P4	
27.8 x 10.2	LL01CR-ACZxxL02	FWHM: 24° 38°	Cree XP-E, XML, XM-L2, XM-L EZW Edison ET-3535, Federal 5050(White) Osram Oslon Square Sharp Petite Zenigata	
28.8 x 15.95	LL01CR-AVC30L	FWHM: 30°	Cree XP-E	
29.1 x 19.8	LL01ED-DI10L06	Full angle: 10°	Edison 1LA5	
31 x 11.2	LL01ED-CTxxL06	Full angle: 38° 80°	Cree XPE, XHG, MX3, MX6 Edison 1LA5 Lumileds Rebel Seoul P4	
31 x 19.3	LL01ED-AJxxL06-M2	FWHM: 10° Full angle: 25° 40° 60°	Edison 1LA5	



25 mm
|
31 mm

DXH (mm)	Part Number	Degree	LED	Picture
32.8 x 18	LL01CR-DGxxL06-M2	Full angle: 20° 30° 40° 50° 60°	Cree XPE, XP-E2, XP-G, XP-G2, XBD, XQD, XM-L, XM-L2, MC-E, MK-R, CXA 1304 Citizen CL-L010 Edison Federal 5050(White) Lgit Ceramic 3535 V2 Lumileds Luxeon T Nichia NVS19A, NVS19B Osram Oslon Square Sharp Petite Zenigata	
32.8 x 18	LL01LU-DGxxL06-M2	Full angle: 20° 30° 40° 50° 60°	Cree MK-R Lumileds Luxeon M	
32.8 x 18	LL01CR-WIxxL02-M2 (Tape available)	FWHM: 15° 25° 40°	Cree XML	
34 x 15.7	LL01CR-BGS24L06	FWHM: 24°	Cree CXA1507	
34.4 x 18.8	LL01ED-AKxxL06	Full angle: 25° 40°	Cree MC-E Color, XM-L Color Edison Federal 5050 Color Osram Ostar SMD color	
34.5 x 18.6	LL01ED-PMxxL06	Full angle: 25° 40°	Edison 1LA5	
35 x 10.65	LL01CR-ADT30L06	FWHM: 30°	Cree XP-E, XP-G2, MC-E/ Color Lumileds Luxeon T Osram Oslon Square, Ostar Edison ET-3535 Citizen CLL430	
35 x 10.7	LL01ED-ACZxxL02	FWHM: 24° 38°	Cree XP-E, XM-L, XM-L2, XM-L EZW Edison ET-3535, Federal 5050(White) Osram Oslon Square, Ostar	
35 x 20	LL01CR-BLU03L06	FWHM: 3°	Cree XP-E2, XP-G2 Osram Oslon Square	
35 x 20.15	LL01CR-ZExxL02	Full angle: 20° 30° 45°	Cree MTG, MKR, MT-G2 Lumileds Luxeon M, Luxeon S Seoul A4 Sharp Mini Zenigata	







DXH (mm)	Part Number	Full Angle	LED	Picture
35.8 x 15.75	LL01CR-FOxxL06	Full angle: 40°	Cree XM-L2 Edison ET-3535, Federal 5050(White) Lumileds Luxeon T Osram Oslon Square	
35.8 x 15.85	LLL01CR-BMxxL06	Full angle: 15° 40°	Cree XRE	
35.8 x 16.5	LL01ED-BBxxL06	Full angle: 25° 40° 60°	Edison 1LA5	
37.2 x 15.35	LL01OS-BWxxL06	Full angle: 10° 30°	Edison 1LA5 Lumileds Rebel, Luxeon A, Luxeon R Nichia NVS19A, 183A Osram W5AM, Oslon SSL 80/ SSL 150 Seoul P4, Z5	
37.2 x 15.35	LL01OS-BYxxL06	Full angle: 10° 30°	Cree XP-E2 Edison 1LA5, Federal 3045/ 3535 Lumileds Rebel, Luxeon A/R/T Nichia NVS19A, 183A Osram W5AM, Oslon SSL 80/ SSL 150 Seoul P4, Z5	
38.1 x 20.2	LL01ED-BCQxxL06-M1	FWHM: 15° 15°x30°	Cree XM-L Color Edison Federal 5050 Color Osram Ostar SMD color	 
38.1 x 20.9	LL01CR-BCQxxL06-M1	FWHM: 15° 15°x30°	Cree MC-E Color	 
39.1x34.1x32.2	LL01LU-ABW1050L02-M2	FWHM: 10°x50°	All single chip LED.	
42 x 9.65	LL01SP-AVA40L06	FWHM: 40°	Sharp Petite/ Mini/ Mega Zenigata	
43.8 x 24.5	LL01ED-AYxxL06-M2	Full angle: 10° 38°	Cree XM-L2, MCE, MTG, MTG2 Citizen CLL010 Lumileds Luxeon M/ Luxeon S	



35 mm
|
44 mm



43 mm
|
76 mm











DXH (mm)	Part Number	Degree	LED	Picture
43.8 x 24.5	LL01ED-FGxxL06-M2	Full angle: 10° 38°	Edison VF23	
45 x 26.3	LL01CR-ANWxxL06	FWHM: 10° 20° 30°	Cree MC-E Color Osram Ostar SMD color	
45 x 26.3	LL01CR-BJH10L06	FWHM: 10°	Cree XM-L	
52 x 27	LL01ZZ-AHA05L06-M2 (Tape available)	FWHM: 5°	Cree XP-E, XM-L2 Lumileds Rebel, Rebel ES Nichia NCS19, NVS19, NVS19B Osram Oslon SSL 80	
69 x 22.7	LL01CT-BBXxxL06	FWHM: 24° 38°	Citizen CLL020	
75.8 x 35.2	LL01CR-ADPxxL06	FWHM: 15° 24° 38°	Cree MK-R, MT-G EZW, MT-G2 Lumileds Luxeon M, Luxeon S	











LENS Series

COB Solution

Commercial lighting

DXH (mm)	Part Number	Degree	Material	LED	Picture
29.9 X 12	LL01ED-ACA24L14	FWHM: 24°	PC1250Y	Edison EdiPower II EPCX-HR96	
30X17	LL01NI-QlxxL06-M2	Full angle: 25°	PMMA	Nichia 110	
34x15.7	LL01CR-ABGxxL02	Full angle: 24° 38° 55°	PC	Cree MTG Lumileds Luxeon M/ S Nichia 036	
43.8x24.5	LL01ED-AYxxL06	FWHM: 10° 38°	PMMA	Cree CXA1304/ 1507/ 1512 Citizen CLL010/CLL020 Lumileds Luxeon M/ S Nichia 036 Sharp Mini Zenigata	
44x14.1	LL01ED-ABY24L02	FWHM: 24°	PC	Cree XM-L/ XM-L EZW/ CXA15xx Nichia 036/ 066 Sharp Petite Zenigata	
44x14.1	LL01CR-AQH(38/45)L02	FWHM: 38° 45°	PC	Cree XM-L/ XM-L EZW/ CXA15xx Nichia 036/ 066 Sharp Petite Zenigata	
45X23.6 / 47.2x25.6	LL01CR-PVxxL02-Mx	Full angle: 45° 60° 80°	PC	Cree CXA1304/ 1507/ 1512 Citizen CLL010/CLL020 Lumileds Luxeon M/ S Nichia 036/ 066/ 110/ 121 Sharp Mini Zenigata	
50X10.4	LL01CR-ABHxxL02	FWHM: 40° 60°	PC	Cree CXA1507/ 1512 Citizen CLL030 Edison EdiPower II EPCX-HR96 Nichia 036/ 066/ 110/ 121 Sharp Mini Zenigata	
74x3	LL01CR-BAAxxL02	FWHM: 24°	PC	Cree CXA2520/ 2530 Edison EdiPower II EPCX-HR96/ EPSX-HRB8	
74.4x13 / 76.4x16.7(Holder)	LL01ZZ-AOFxxL06-Mx	FWHM: 24° 38°	PMMA	Cree CXA15xx/ 1816/ 25xx Citizen CLL020 Edison EdiPower II EPCX-HR96/ EPSX-HRB8 Lumileds LHCI 1203/ 1204/ 1205/ 1208 Nichia 066/ 121 Sharp Mini/ Mega Zenigata	

DXH (mm)	Part Number	Degree	Material	LED	Picture
75.8x24.35	LL01ED-ABXxxL06	FWHM: 24° 38°	PMMA	Cree CXA15xx/ 1816/ 25xx Citizen CLL030/ 040 Edison EPCX-HR96/ EPSX-HRB8/ HRBF/HRBJ Lumileds LHCI 1204/ 1205/ 1208 Nichia 066/ 121 Sharp Mini/ Mega Zenigata	
76x22.5	LL01CR-BAYxxL06	FWHM: 24° 38°	PMMA	Cree CXA15xx Citizen CLL020/ 030 Lumileds LHCI 1203/ 1204/ 1205/ 1208 Nichia 066 Sharp Mega Zenigata	
76x23	LL01CT-AMYxxL06	FWHM: 24° 38°	PMMA	Cree CXA1816/ 25xx/ 3050 Citizen CLL030/ 040 Osram Ostar Lumileds LHCI 1204/ 1205 Nichia 121 Sharp Mini Zenigat	
76.1 x 12.7	LL01CT-AZWxxL02-P	FWHM: 15° 24° 38°	PC	Cree CXA1512 Citizen CLL020 Lumileds LHCI 1203/ 1204/ 1205/ 1208 Edison EdiPower II EPSX-HRB8/ EPSX-HRBF Sharp Mini/ Mega Zenigata	
84.6x18/ 90.8x22(Holder)	LL01CT-APGxxL06-Mx	FWHM: 24° 38°	PMMA	Cree CXA15xx/ 25xx/ 3050 Citizen CLL030 Edison EdiPower II EPSX-HRB8/ HRBF/HRBJ Lumileds LHCI 1203/ 1204/ 1205/ 1208 Nichia 066/ 121 Sharp Mini/ Mega Zenigata	
87x44.25	LL01ED-IHxxL-02	Full angle: 60°	PC LEV1700KL	Cree CXA25xx/ 3050 Citizen CLL040 Edison 1LA5/ EPCX-HR96/ EPSX-HRB8/HRBJ	
88.5 x 15	LL01CT-AZNxxL02-P	FWHM: 15° 24° 38°	PC	Cree CXA2520 Citizen CLL030 Edison EdiPower II EPSX-HRB8/ EPSX-HRBF Lumileds LHCI 1203/ 1204/ 1205/ 1208 Sharp Mini/ Mega Zenigata	
90.6x22/ 90.6x27(Holder)	LL01ED-ASAxxLxx-P	FWHM: 12° 24° 38°	PMMA / PC	Cree CXA1816/ 25xx Citizen CLL020/ 030/ 040 Lumileds LHCI 1204/ 1205/ 1208 Nichia 121 Sharp Mini/ Mega Zenigata	















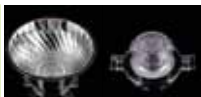

















LENS Series

Reflector

Commercial lighting

DXH (mm)	Part Number	Degree	Material	LED	Reflector	Fitting
35.2 x 7.8	LL01ED-AJMxxR49	FWHM: 24° 38°	Aluminum	Cree CXA1304/1507(holder)/1512 Citizen CLL010 Nichia 036 Sharp Mini/ Petite Zenigata		
44 x 11.8	LL01CT-AMXxxR49	FWHM: 45°	Aluminum	Citizen CLL010(holder) Nichia 036 Sharp Mini/ Petite Zenigata		
45X19.4	LL01BR-TYRxxR34-P	FWHM: 24° 34° 50°	Plastic Plating	Cree CXA1304/1507/1512/1816 Citizen CLL010/020/030 Edison EPCX-HR96 Sharp Mini Zenigata		
50 X 19	LL01CT-AJZxxR49	FWHM: 36° 50°	Aluminum	Cree CXA1304/1507/1512 Citizen CLL010/020(holder) Nichia 036/ 066 Sharp Mini Zenigata		
50 x 19	LL01ED-ALixxR49	FWHM: 24° 38° 55°	Aluminum	Cree CXA1304/1507/1512/1816 Citizen CLL010/020 Edison EPCX-HR96(holder) Nichia 036/ 066 Sharp Mini Zenigata		
50 X 30	LL01CIOTxxR2-P	FWHM: 20° 33° 45°	Plastic Plating	Citizen CLL030(holder) Edison EPCX-HR96 Sharp Mini Zenigata		
50 X 30/ 50.5X30(45°)	LL01ED-AKYxxR49	FWHM: 24° 38° 45°	Aluminum	Cree CXA1507/1512 Edison EPCX-HR96(holder) Nichia 036/ 066 Sharp Mini Zenigata		
50.5 x 29.5	LL01ED-AKVxxR49	FWHM: 36°	Aluminum	Cree CXA1507/1512/2540 Citizen CLL020 Edison EPSX-HRB8(holder) Nichia 036/ 066 Sharp Mini Zenigata		
70 X 35	LL01ZZ-AAAxL49	FWHM: 24° 38° 55°	Aluminum	Cree CXA1507/1512/1816 Citizen CLL020/030 Edison EPCX-HR96 Lumileds LHCI 1204/1205/1208 Nichia 036/ 066/ 121 Sharp Mini Zenigata		 Fresnel Lens
75 x 20.1	LL01ED-ALAxR49	FWHM: 24° 38°	Aluminum	Cree CXA1507/1512 Citizen CLL020/030 Edison EPSX-HRB8(holder) Nichia 066/ 121 Sharp Mega Zenigata		

DXH (mm)	Part Number	Degree	Material	LED	Reflector	Fitting
75 x 40	LL01SP-ATHxxR49	FWHM: 15° 24° 38°	Aluminum	Cree CXA1507/1512/1816(holder) Citizen CLL020/CLL040(holder) Lumileds LHCI 1203/1204/1205/12808 Nichia 036/066/121 Sharp Mega Zenigata(holder)		
75 x 45	LL01CR-AYGxxR49	FWHM: 15° 24° 38°	Aluminum	Cree CXA1304/15xx(connector)/1816 Citizen CLL010/020/030 Edison EPCX-HR96 Sharp Mini/ Mega Zenigata		
75 x 45	LL01CT-AYTxxR35-P	FWHM: 15° 24° 38°	Plastic Plating	Citizen CLL020(connector)		
75 x 45	LL01CR-BGCxxR49-BKG15L02	FWHM: 15° 24° 38°	Aluminum	Cree CXA1816/ 1830		
75.8 x 20.1	LL01CT-ALNxxR49	FWHM: 38° 45°	Aluminum	Cree CXA1507/1512 Citizen CLL020(holder) Nichia 036/066 Sharp Mini Zenigata		
85 x 23.5	LL01ED-AKAxxR49	FWHM: 60°	Aluminum	Cree CXA1816/25xx(holder)/3050 Citizen CLL030 Edison EPSX-HRB8/HRBF/HRBJ(holder) Nichia 066/121 Sharp Mini/ Mega Zenigata		
90 x 40	LL01CR-BDJ80R49	FWHM: 80°	Aluminum	Cree CXA1816/ 1820(holder)		
90 x 50	LL01SP-ASOxxR49	FWHM: 5° 24° 38° 55°	Aluminum	Cree CXA1816(holder) Citizen CLL030/CLL040(holder) Lumileds LHCI 1203/1204/1205/12808 Nichia 066/ 121 Sharp Mega Zenigata(holder)		
90 x 50	LL01CR-AYMxxR35-P	FWHM: 15° 24° 38°	Plastic Plating	Cree CXA25xx(connector)		
90 x 50	LL01CT-AYXxxR35-P	FWHM: 15° 24° 38°	Plastic Plating	Citizen CLL030(connector)		











DXH (mm)	Part Number	Degree	Material	LED	Reflector	Fitting
90.5 x 23.2	LL01CT-ALOxxR49	FWHM: 24° 38° 45°	Aluminum	Cree CXA1507/1512/1816 Citizen CLL030(holder) Edison EPSX-HRB8 Sharp Mini/ Mega Zenigata		
91.5 x 23.2	LL01ED-ALJxxR49	FWHM: 24° 38° 45°	Aluminum	Cree CXA1816/25xx(holder)/3050 Citizen CLL030 Edison EPSX-HRBF/ HRBJ(holder) Nichia 121 Sharp Mega Zenigata		
93 x 35	LL01CT-BKY15R49-BLB110L51	FWHM: 15°	Aluminum	Citizen CLL032		
93 x 35	LL01CT-BKY24R49-BLB140L51	FWHM: 24°	Aluminum	Citizen CLL032		
93 x 35	LL01CT-BKY36R49-BLB130L51	FWHM: 36°	Aluminum	Citizen CLL032		
93 x 35	LL01CT-BKY75R49-BLB120L51	FWHM: 75°	Aluminum	Citizen CLL032		
100 x 57	LL01CR-BIYxxR49-BIZ120L0	FWHM: 13° 24°	Aluminum	Cree CXA1816/ 1830		
116 x 32	LL01ED-AKXxxR49	FWHM: 24° 38°	Aluminum	Cree CXA25xx(holder)/3050 Citizen CLL030 Edison EPSX-HRBJ/HRBF(holder) Nichia 121 Sharp Mega Zenigata		



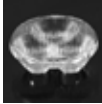









LENS Series

Multi LENS





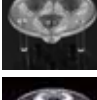





Commercial lighting







DXH (mm)	Part Number	Degree	LED	Picture
21.8x7.9	LL03CR-ARHxxL06	FWHM: 38°	Cree XPE	
23.1x10.83	LL03CR-BDMxxL06	FWHM: 20° 40° 60°	Cree XTE	
23.1x10.83	LL03LU-MKxxL06	Full angle: 15° 25°	Nichia NCS19A/NVS19A	
23.1x11	LL03LU-DMxxL06	Full angle: 15° 25° 40°	Cree XPE/XPG Edison Federal 3045 Lumileds Rebel Osram Oslon SSL 80	
31x11.2	LL03ED-CTxxL06	Full angle: 38° 80°	Cree MX6 Edison 1LA5 Lumileds Luxeon T Nichia 757	
33x6.9	LL03ZZ-EUxxL06	Full angle: 38°	Cree XRE/MX6 Nichia 183A/757	
33.2x9.8	LL03OS-GKxxL06	Full angle: 25° 40° 60° 80°	Osram Oslon SSL 80	
33.2x10.2	LL03ED-GKxxL06	Full angle: 25° 40° 60°	Edison Federal 3045 Seoul Z5	
33.2x10.3	LL03ED-UYxxL06	Full angle: 40° 60°	Edison Federal 3045 Lumileds Luxeon T	
33.2x10.15	LL03CR-GKxxL06	Full angle: 80°	Cree XPG2	



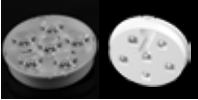

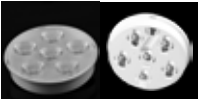

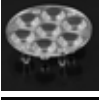

DXH (mm)	Part Number	Degree	LED	Picture
34x9.9	LL03CR-CExxL06	Full angle: 38°	Cree XRE/XTE/MX3/MX6 Edison Federal 5050 Lumileds Rebel Nichia 183A Osram Oslon Square	
34x9.9	LL03ED-CExxL06	Full angle: 38°	Edison 1LA5	
34.8x10.8	LL03CR-EQxxL06	Full angle: 38°	Cree XRE	
34.9x10.4	LL03ED-AllxxL06	FWHM: 30°	Edison 1LA5	
35x7	LL03DD-AMGxxL06	FWHM: 38°	Cree XPE	
35x7.9	LL03CR-ARlxxL0	FWHM: 38°	Cree XPE	
35x8.2	LL03CR-HKxxL06	Full angle: 40°	Cree MX6 Nichia 383/757 Lumileds Luxeon A Osram Oslon Square	
35x9	LL03CR-EKxxL06	Full angle: 40° 60°	Cree MX3 Nichia 183A	
35x9.2	LL03ED-EKxxL06	Full angle: 25° 40° 60°	Edison 1LA5	
35x9.6	LL03CR-RXxxL06	Full angle: 25° 40° 60°	Cree XPE/XPG Lumileds Luxeon T	











DXH (mm)	Part Number	Degree	LED	Picture
35x10.5	LL03NI-QQxxL06	Full angle: 15°	Nichia NVS19A/NCS19A	
35x10.6	LL03LU-DOxxL06	Full angle: 15° 25° 40°	Cree XPE/XPG Edison Federal 3045 Lumileds Rebel Osram Oslon SSL 80/Square	
35x10.8	LL03CR-BDOxxL06	FWHM: 15° 25°	Cree XBD	
37x8.7	LL03ED-AIHxxL06	FWHM: 30°	Edison 1LA5	
37.7x10.5	LL03ED-ASxxL06	Full angle: 38° 60°	Edison 1LA5	
43.9x9.5	LL03ED-BCxxL06	Full angle: 15° 25°	Edison 1LA5 Lumileds Luxeon T	
44.5x10.2	LL03CR-GWxxL06	Full angle: 25°	Cree XRE/MX6 Nichia 183A/757	
50x14.5	LL03CR-AZxxL06	Full angle: 25° 45° 60°	Cree XPE/XPG	
50.5x13	LL03ED-BAxxL06	Full angle: 25° 40° 60°	Edison 1LA5	
50.5x13	LL03ED-AZxxL06	Full angle: 25° 45° 60°	Edison 1LA5	
50.5x20.65	LL03ED-AFxxL06	Full angle: 10° 30° 45° 60° 40°x70°	Edison 1LA5	

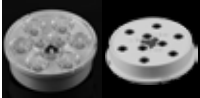



DXH (mm)	Part Number	Degree	LED	Picture
22x6.7	LL04CR-ABDxxL06	FWHM: 24° 36°	Cree XPE/XBD	
22.2x6.7	LL04CR-GPxxL06	Full angle: 25° 38° 45°	Cree XPE Osram Oslon SSL 80 Samsung LH351B	
22.2x6.8	LL04LU-GPxxL06	Full angle: 15° 25° 45°	Lumileds Rebel/Rebel Es Samsung LH351B	
25.4x10.4	LL04ED-EXxxL06	Full angle: 60°	Cree XPE Edison Federal 3045	
25.4x10.4	LL04ZZ-EXxxL06	Full angle: 30°	Cree XPE Edison Federal 3045 Lumileds Rebel	
25.4x10.5	LL04LU-DNxxL06	Full angle: 15° 25° 40°	Cree XPE/XPG Lumileds Rebel Osram Oslon SSL 80	
25.4x11.3	LL04LU-MKxxL06	Full angle: 15°	Lumileds Rebel	
35x7	LL04DD-AMGxxL06	FWHM: 38°	Cree XPE Lumileds Rebel ES Nichia 757	
35x9.7	LL04CR-RXxxL06	Full angle: 25° 40° 60°	Cree XPE/XPG/XBD	
35x10.4	LL04LU-DOxxL06	Full angle: 15° 25° 40°	Cree XPE/XPG Lumileds Rebel Osram Oslon SSL80/Square	
35x10.5	LL04NI-DOxxL06	Full angle: 25° 40°	Nichia 757	







DXH (mm)	Part Number	Degree	LED	Picture
35x10.5	LL04NI-QQxxL06	Full angle: 15°	Nichia NCS19A/NVS19A	
37x9.8	LL04OS-GKxxL06	Full angle: 40° 60° 80°	Cree XPE/XPG Citizen ET-3535 Lumileds Luxeon T Nichia NCS19A/NVS19A Osram Oslon SSL 80 Seoul Z5P	
37x10.3	LL04ED-GKxxL06	Full angle: 25° 40° 60°	Edison Federal 3045	
37x10.3	LL04ED-UYxxL06	Full angle: 24° 36°	Edison Federal 3045	
43.9x9.5	LL04ED-BDxxL06	Full angle: 15° 25° 40°	Edison 1LA5	
35.8x6.3	LL05CR-BFRxxL06	FWHM: 25° 40° 60°	Cree XTE Nichia NVS19B/ 757	
35.8x6.5	LL05CR-FRxxL06	Full angle: 25° 40° 60°	Cree XPE/XPG	
43.9x8.6	LL06ED-BExxL06	Full angle: 15° 25°	Edison 1LA5	
50x9.65	LL06CR-RXxxL06	Full angle: 25° 40° 60°	Cree XPE/XPG/XPG2/XTE/XBD Edison Federal 3535/ET-3535 Lumileds Rebel/RebelES/LuxeonA/T Nichia NCS19A/NVS19B Osram Oslon SSL80/Oslon Square Samsung LH351B LGIT ceramic 3535	
73.3x11.5	LL06ED-ADxxL06	Full angle: 8° 25° 40° 60°	Edison 1LA5	

DXH (mm)	Part Number	Degree	LED	Picture
73.2x13.5/ 76x16.1(holder)	LL06CR-CKxxL06-Mx	Full angle: 10° 25°	Cree XRE	
73.2x13.5/ 76x16.2(holder)	LL06ED-AExxL06-Mx	Full angle: 8° 25° 40°	Edison 1LA5	
73.2x13.5/ 76x16.2(holder)	LL06ED-ATxxL06-Mx	Full angle: 40°	Cree XPE/XPG/XBD/MX3(6)/XML Edison 1LA5/Federal3045/3535/5050/ET-3535 Lumileds Rebel/Luxeon M Nichia NCS19A/183A/NVS19A Osram Oslon SSL 80/150/Square Samsung Sunnix8	
73.2x13.5/ 76x16.2(holder)	LL06ED-DKxxL06-Mx	Full angle: 60°	Cree XML/MCE/MKR Citizen CLL430 Edison 1LA5 Lumileds Rebel/Luxeon M Nichia 183A Osram Oslon SSL 80 Seoul A4	
73.3x16	LL06CY-TTxxL06	Full angle: 45°	Cree XPE/XTE/XBD	
35.8x6.3	LL07CR-BFRxxL06	FWHM: 25° 40° 60°	Cree XTE Nichia NVS19B/757	
35.8x6.5	LL07CR-FRxxL06	Full angle: 25° 40° 60°	Cree XPE/XPG	
39.2x10.8	LL07ZZ-FVxxL06	Full angle: 15° 25° 30° 60°	Cree XPE LGIT ceramic 3535 Seoul Z5	
43.9x8.55	LL07ED-BFxxL06	Full angle: 15° 25°	Edison 1LA5 Lumileds Rebel ES	

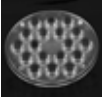
DXH (mm)	Part Number	Degree	LED	Picture
47x9.8	LL07OS-GKxxL06	Full angle: 40° 60° 80°	Edison ET-3535 Lumileds Luxeon T Nichia NCS19A/NVS19A Osram Oslon SSL 80 Seoul Z5P	
47x10.3	LL07ED-UYxxL06	Full angle: 40° 60°	Edison Federal 3045	
47x10.5	LL07ED-GKxxL06	Full angle: 25° 40° 60°	Edison Federal 3045 Seoul Z5	
50x10.3	LL07CR-RXxxL06	Full angle: 40° 60°	Cree XPE/XPG/XPG2/XTE/XBD Edison Federal 3535/ET-3535 Lumileds Rebel/RebelES/LuxeonA/T Nichia NCS19A/NVS19B Osram Oslon SSL80/Oslon Square Samsung LH351B LGIT ceramic 3535	
50.35x10.7	LL07ZZ-FUxxL06	Full angle: 15° 25°	Cree XPE/XPG Edison Federal 3045 Lumileds Rebel Osram Oslon SSL80/Oslon Square	
43x8.5	LL08NI-BEBxxL02	FWHM: 25° 40°	Nichia 757	
45x7	LL09CR-FRxxL06	Full angle: 25° 40° 60°	Cree XPE/XPG	
67x9.8	LL09OS-GKxxL06	Full angle: 40° 60° 80°	Cree XPE/XPG Edison ET-3535 Lumileds Luxeon T Nichia NCS19A/NVS19A Osram Oslon SSL 80 Seoul Z5P	
67x10.3	LL09ED-UYxxL06	Full angle: 40° 60°	Edison Federal 3045	

DXH (mm)	Part Number	Degree	LED	Picture
67x10.8	LL09ED-GKxxL06	Full angle: 25° 40° 60°	Edison Federal 3045	
70x10.3	LL09CR-RXxxL06	Full angle: 40°	Cree XPE/XPG/XPG2/XTE/XBD Edison Federal3045/3535/ET-3535 Lumileds Rebel/Rebel Es/LuxeonA/T Nichia NCS19A/NVS19B Osram Oslon SSL80/Square Samsung LH351B	
90.6x16.5/ 93.8x20.1(holder)	LL09ED-ATxxL06-Mx	Full angle: 15° 25° 45°	Cree MX3/MX6/XML/XML EZW/XBD Edison 1LA5/Federal 3045/5050 Lumileds Rebel Nichia NCS19A/183A/NVS19A Samsung Sunnix8 LGIT ceramic3535	
90.6x16.5/ 93.8x20.1(holder)	LL09ED-BQxxL06-Mx	Full angle: 60°	Edison 1LA5	
90.6x16.5/ 93.8x20.1(holder)	LL09ED-BZxxL06-Mx	Full angle: 15° 25°	Edison 1LA5 Lumileds Rebel ES	
90.6x16.5	LL09ED-MSxxL06	Full angle: 40°	Edison 1LA5	
90.6x18.8	LL09CY-TTxxL06	Full angle: 45°	Cree XPE/ XTE	
90.75x16.5	LL09ED-BZxxL06	Full angle: 15° 25°	Edison 1LA5 Lumileds Rebel ES	
95.4x13.5	LL09ED-ACxxL06	Full angle: 15° 25°	Edison 1LA5	
45x7	LL12CR-FRxxL06	Full angle: 25° 40° 60°	Cree XPE/ XPG	

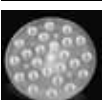
DXH (mm)	Part Number	Degree	LED	Picture
67x9.8	LL12OS-GKxxL06	Full angle: 40° 60° 80°	Cree XPE/XPG Edison ET-3535 Lumileds Luxeon T Nichia NCS19A/NVS19A Osram Oslon SSL 80 Seoul Z5P	
67x10.3	LL12ED-UYxxL06	Full angle: 40° 60°	Edison Federal 3045	
67x10.8	LL12ED-GKxxL06	Full angle: 25° 40° 60°	Edison Federal 3045	
70x10.3	LL12CR-RXxxL06	Full angle: 40° 60°	Cree XPE/XPG/XPG2/XTE/XBD Edison Federal 3045/3535/ET-3535 Lumileds Rebel/Rebel Es/LuxeonA/T Nichia NCS19A/NVS19B Osram Oslon SSL 80/Oslon Square Samsung LH351B	
90.6x16.5/ 93.5x20.3 (holder)	LL12ED-BQxxL06-Mx	Full angle: 25°	Edison 1LA5	
95x11	LL12ED-HIxxL06	Full angle: 40°	Edison 1LA5	
95x11.2	LL12ED-BGxxL06	Full angle: 15° 25° 40°	Edison 1LA5	
122x13.4	LL12ED-AGxxL06	Full angle: 25° 40°	Edison 1LA5	
62x8.5	LL13NI-BEBxxL02	FWHM: 25° 40°	Nichia 757	
95x11.1	LL15ED-BHxxL06	Full angle: 15° 25° 40°	Edison 1LA5	







DXH (mm)	Part Number	Degree	LED	Picture
110x13.1	LL18ED-BIxxL06	Full angle: 15° 25° 40°	Edison 1LA5	
110x13.1	LL18NI-BEBxxL06	FWHM: 25° 40°	Nichia 757	
99x90x10.3	LL24CR-VExxL02	Full angle: 15°	Cree XPE/ XPG	
113.6x76x9	LL24CR-PFxxL02	Full angle: 15°	Cree XPE/ XPG	
174.5x12.7	LL24ED-ABxxL06	Full angle: 15° 25° 45°	Edison 1LA5	
140x12.6	LL36ED-AAxxL06	Full angle: 15° 25° 45°	Edison 1LA5	
180x13.1	LL60ED-BOxxL06	Full angle: 25° 45°	Edison 1LA5 Seoul A4	



LENS Series

Convex Lens

Commercial lighting

DXH (mm)	Part Number	Degree	LED	Picture
16.7x6.7	LL01ED-AWxxL	Full angle: 60°	All single chip LED.	
22.1x6.8	LL01ED-AVxxL	Full angle: 60°	All single chip LED.	
22.1x7.6	LL01ED-DPxxL	Full angle: 60°	All single chip LED.	
22.1x10.5	LL01ED-CCxxL	Full angle: 40°	All single chip LED.	
22.5x7.6	LL01ED-AQxxR	Full angle: 60°	All single chip LED.	
26.7x17.8	LL01ED-AQ60R-Mx	Full angle: 60°	Edison 1LA5 Seoul P4	
26.7x17.8	LL01ED-CJxxL-Mx	Full angle: 60°	All single chip LED.	
28.8x7.3	LL01ZZ-FSxxL	Full angle: 60°	All single chip LED.	
37.2x10	LL01OS-DCxxL	Full angle: 56° 76°	All single chip LED.	
60.3x32.5	LL01ED-AIxxL-Mx	Full angle: 60°	All single chip LED.	



LENS APPLICATION
STREET LIGHTING

LL01CR-APM80150L02

Brightness Asymmetrical



Tape available

DxWxH(mm): 18x12.5x6.95
FWHM : 80°x150°

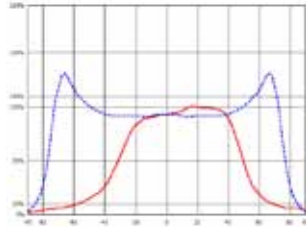

(Type II ,Short)

CREE XT-E	OSRAM --
PHILIPS LUMILEDS Rebel	SAMSUNG LED Ceramic3535
EDISON --	LG Innotek --
NICHIA NVS19	SEKUL --

LL01CR-DL90120L02

Illuminance Asymmetrical Tunnel



DxWxH(mm): 26x15.8x9.15
FWHM : 90°x120°

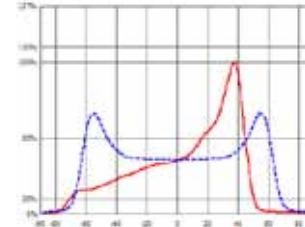

(Type I ,Very Short)

CREE XP-E(2)/ XP-G(2)	OSRAM --
PHILIPS LUMILEDS --	SAMSUNG LED --
EDISON --	LG Innotek --
NICHIA --	SEKUL --

LL01CR-AU85135L02

Illuminance Asymmetrical



DxWxH(mm): 18x10.2x6.1
FWHM : 80°x135°

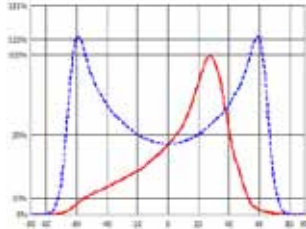

(Type I ,Short)

CREE XB-D/ XP-E(2)/ XP-G(2)	OSRAM Oslon SSL 80 / Square
PHILIPS LUMILEDS Rebel / Rebel ES	SAMSUNG LED Ceramic3535
EDISON --	LG Innotek Ceramic3535
NICHIA NCS19/ NVS19/ NVS19B	SEKUL --

LL01CR-FT60135L02

Illuminance Symmetrical



DxWxH(mm): 18x9.3x5.9
FWHM : 60°x135°

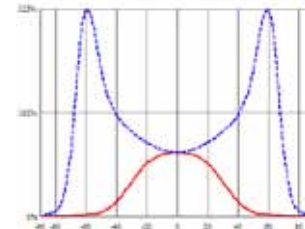

(Type I ,Short)

CREE XB-D/ XP-E(2)/ XP-G(2)	OSRAM Oslon SSL 80 / Square
PHILIPS LUMILEDS LuxeonT/ Rebel/ Rebel ES	SAMSUNG LED Ceramic3535
EDISON --	LG Innotek Ceramic3535
NICHIA NCS19/ NVS19/ NVS19B	SEKUL --

LL01CR-DL70130L02

Illuminance Asymmetrical Tunnel



DxWxH(mm): 26x12.7x8.65
FWHM : 70°x130°

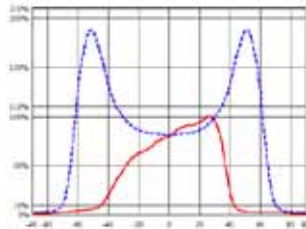

(Type I ,Short)

CREE XP-E(2)/ XP-G(2)	OSRAM --
PHILIPS LUMILEDS --	SAMSUNG LED --
EDISON --	LG Innotek --
NICHIA --	SEKUL --

LL01CR-KM6090L02

Illuminance Symmetrical



Tape available

DxWxH(mm): 17.55x11.6x8.6
FWHM : 60°x90°

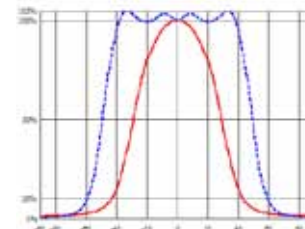

(Type I ,Very Short)

CREE XP-E(2)/ XP-G(2)	OSRAM Oslon SSL 80 / Square
PHILIPS LUMILEDS Rebel/ Rebel ES	SAMSUNG LED Ceramic 3535
EDISON --	LG Innotek Ceramic 3535
NICHIA NCS19/ NVS19/ NVS19B/ 757	SEKUL --

LL01CR-OG85150L02

ILLUMINANCE Symmetrical

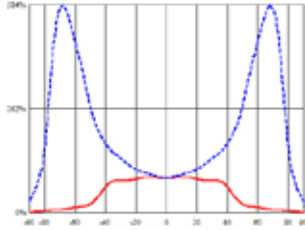

(Type II ,Medium)

DxWxH(mm): 18x8.95x6.2
FWHM : 85°x150°

- CREE** XB-D/ XP-E(2)/ XP-G(2)
- PHILIPS LUMILEDS** Rebel/ Rebel ES
- EDISON** --
- NICHIA** NVS19B

- OSRAM** Oslon Square
- SAMSUNG LED** Ceramic3535
- LG Innotech** --
- SEKUL** --

LL01CR-XW70140L02

BRIGHTNESS Asymmetrical

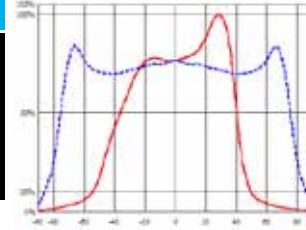

(Type II ,Short)

DxWxH(mm): 32x17.6x9.8
FWHM : 70°x140°

- CREE** XM-L
- PHILIPS LUMILEDS** Luxeon M
- EDISON** --
- NICHIA** 383

- OSRAM** --
- SAMSUNG LED** --
- LG Innotech** --
- SEKUL** --

LL01CR-OW70130L02

ILLUMINANCE Asymmetrical

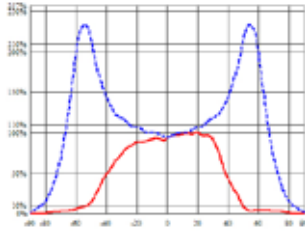

(Type I ,Short)

DxWxH(mm): 17.4x12.75x7.2
FWHM : 70°x130°

- CREE** XB-D/XP-E(2)/ XP-G(2)/ XM-L/ XT-E
- PHILIPS LUMILEDS** Luxeon T/ Rebel
- EDISON** --
- NICHIA** NCS19/ NVS19/ NVS19B/ 383/ 757

- OSRAM** Oslon SSL 80 / Square
- SAMSUNG LED** Ceramic3535
- LG Innotech** Ceramic3535
- SEKUL** --

LL01ED-AU70120L02

ILLUMINANCE Asymmetrical

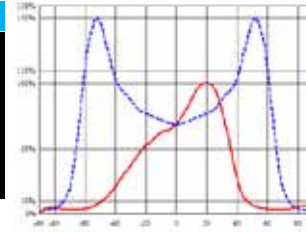

(Type I ,Short)

DxWxH(mm): 9.4x42x28.4
FWHM : 70°x120°

- CREE** CXA2530
- PHILIPS LUMILEDS** --
- EDISON** Edistar
- NICHIA** --

- OSRAM** --
- SAMSUNG LED** --
- LG Innotech** --
- SEKUL** --

LL01CR-PB70140L02

ILLUMINANCE Asymmetrical

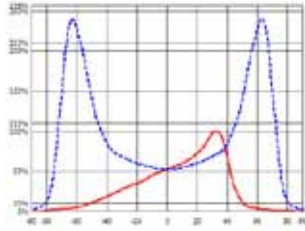

(Type II ,Short)

DxWxH(mm): 22.4x11.4x6.9
FWHM : 70°x140°

- CREE** XB-D/ XP-E(2)/ XP-G(2)/ XT-E
- PHILIPS LUMILEDS** --
- EDISON** --
- NICHIA** NVS19B

- OSRAM** --
- SAMSUNG LED** Ceramic 3535
- LG Innotech** Ceramic 3535
- SEKUL** --

LL01ED-AU70135L02

ILLUMINANCE Symmetrical

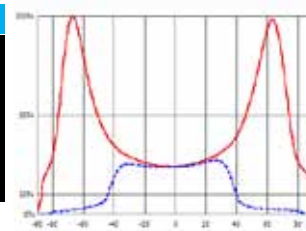

(Type I ,Short)

DxWxH(mm): 24x12.3x9.2
FWHM : 70°x135°

- CREE** --
- PHILIPS LUMILEDS** --
- EDISON** 1LA5
- NICHIA** --

- OSRAM** --
- SAMSUNG LED** --
- LG Innotech** --
- SEKUL** P4

LL01ED-LP70130L02

Illuminance Asymmetrical



DxWxH(mm): 20x11.7x6.9
FWHM : 70°x130°

- CREE --
- PHILIPS LUMILEDS --
- EDISON 1LA5
- NICHIA --

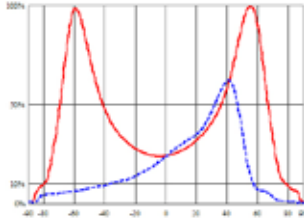

(Type II ,Short)

- OSRAM --
- SAMSUNG LED --
- LG Innotek --
- SEKUL P4

LL01LU-AEV50150L02

Brightness Asymmetrical



Tape available

DxWxH(mm): 18x12.5x6.3
FWHM : 50°x150°

- CREE XP-E(2)/ XP-G(2)
- PHILIPS LUMILEDS Rebel ES
- EDISON --
- NICHIA NVS19B

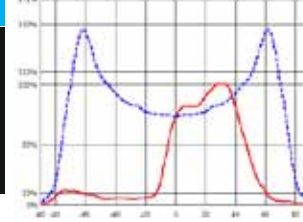

(Type I ,Short)

- OSRAM Oslon Square
- SAMSUNG LED --
- LG Innotek --
- SEKUL --

LL01ED-ZP55140L02

Brightness Asymmetrical



DxWxH(mm): 19.15x10.8x9.4
FWHM : 55°x140°

- CREE --
- PHILIPS LUMILEDS --
- EDISON 1LA5
- NICHIA --

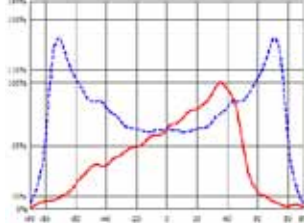

(Type II ,Short)

- OSRAM --
- SAMSUNG LED --
- LG Innotek --
- SEKUL P4

LL01LU-AGV80150L02

Brightness Asymmetrical



DxWxH(mm): 32x18.5x9.5
FWHM : 80°x150°

- CREE XM-L
- PHILIPS LUMILEDS Luxeon M
- EDISON --
- NICHIA 383

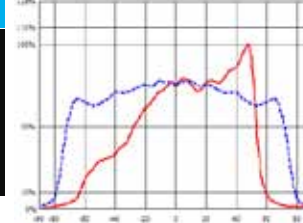

(Type II ,Short)

- OSRAM --
- SAMSUNG LED --
- LG Innotek --
- SEKUL --

LL01SX-ADD60135L02

Brightness Illuminance Asymmetrical



DxWxH(mm): 25.7x16.3x11.4
FWHM : 60°x135°

- CREE --
- PHILIPS LUMILEDS --
- EDISON --
- NICHIA --

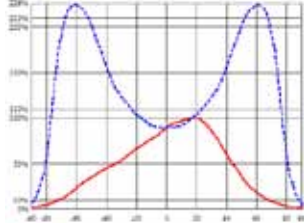

(Type II ,Short)

- OSRAM --
- SAMSUNG LED --
- LG Innotek --
- SEKUL --

LL01LU-AIK45135L02

Illuminance Asymmetrical



Tape available

DxWxH(mm): 18x12.5x7.05
FWHM : 45°x135°

- CREE XP-E(2)/ XP-G(2)
- PHILIPS LUMILEDS Rebel ES
- EDISON --
- NICHIA NCS19/ NVS19/ NVS19B

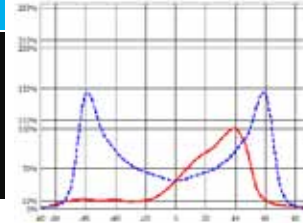

(Type II ,Short)

- OSRAM --
- SAMSUNG LED Ceramic 3535
- LG Innotek --
- SEKUL --

LL01LU-NI75140L02

Illuminance Asymmetrical



DxWxH(mm): 15.7x14x5.8
FWHM : 75°x140°

- CREE XP-G2
- PHILIPS LUMILEDS Rebel
- EDISON --
- NICHIA --

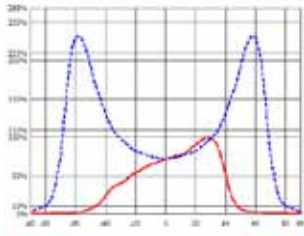

(Type I ,Short)

- OSRAM --
- SAMSUNG LED Ceramic3535
- LG Innotek --
- SEOL --

LL01SH-AU75135L02

Illuminance Symmetrical



DxWxH(mm): 24x13.2x9.6
FWHM : 75°x135°

- CREE --
- PHILIPS LUMILEDS --
- EDISON 1LA5
- NICHIA --

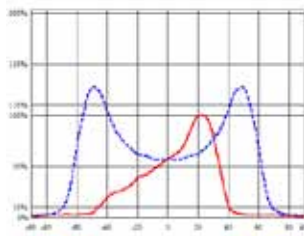

(Type I ,Short)

- OSRAM --
- SAMSUNG LED --
- LG Innotek --
- SEOL P4

LL01LU-UQ70140L02

Brightness Asymmetrical
Illuminance



DxWxH(mm): 18x11x6.6
FWHM : 70°x140°

- CREE XP-G2/ XT-E
- PHILIPS LUMILEDS Rebel/ Rebel ES
- EDISON --
- NICHIA NVS19B

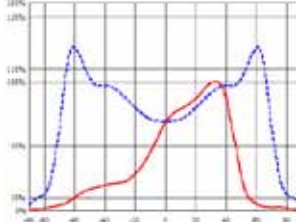

(Type I ,Short)

- OSRAM --
- SAMSUNG LED Ceramic3535
- LG Innotek --
- SEOL --

LL01ZZ-AGX45155L02

Brightness Asymmetrical



DxWxH(mm): 18x12.5x7
FWHM : 45°x155°

- CREE XP-G2
- PHILIPS LUMILEDS Rebel/ Rebel ES
- EDISON --
- NICHIA NCS19/ NVS19

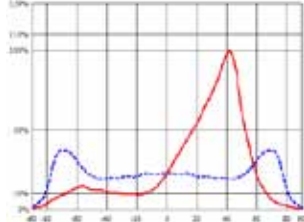

(Type III ,Short)

- OSRAM --
- SAMSUNG LED Ceramic 3535
- LG Innotek --
- SEOL --

LL01OS-AU60140L02

Illuminance Asymmetrical



DxWxH(mm): 16x8.8x5.3
FWHM : 60°x140°

- CREE XP-G2
- PHILIPS LUMILEDS Luxeon T
- EDISON --
- NICHIA NVS19B

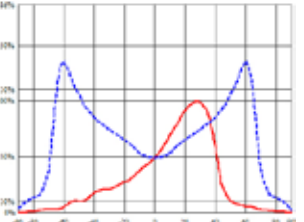

(Type II ,Short)

- OSRAM Oslon SSL 80
- SAMSUNG LED Ceramic 3535
- LG Innotek --
- SEOL --

LL04LZ-NO85140L02

Illuminance Asymmetrical



DxWxH(mm): 160x25x9.55
FWHM : 85°x140°

- CREE --
- PHILIPS LUMILEDS --
- EDISON 1LA5
- NICHIA --

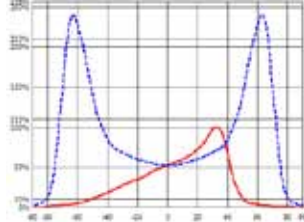

(Type I ,Short)

- OSRAM --
- SAMSUNG LED --
- LG Innotek --
- SEOL --

LL12ED-VT85160L02

Brightness Asymmetrical



DxWxH(mm): 158x50x9.4
FWHM : 85°x160°

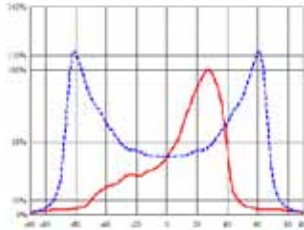

(Type III ,Short)

- | | |
|------|----|
| -- | -- |
| -- | -- |
| 1LA5 | -- |
| -- | -- |

LL14LU-ALY90130L19

Brightness Illuminance Asymmetrical



DxWxH(mm): 250x60x9.3
FWHM : 90°x130°

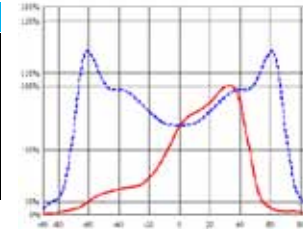

(Type I ,Short)

- | | |
|----------|----|
| -- | -- |
| Rebel ES | -- |
| -- | -- |
| -- | -- |

LL12OS-EL50130L02

Illuminance Asymmetrical



DxWxH(mm): 158.4x50.3x9.1
FWHM : 50°x130°

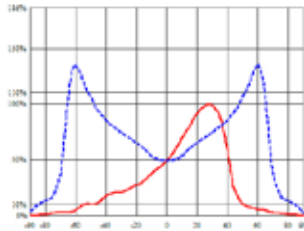

(Type I ,Short)

- | | |
|-----|----|
| MX6 | -- |
| -- | -- |
| -- | -- |
| -- | -- |

LL20CR-VK60140L02

Illuminance Asymmetrical



DxWxH(mm): 319.3x52.3x14.6
FWHM : 60°x140°

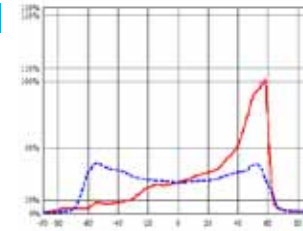

(Type III ,Short)

- | | |
|------------|----|
| XP-G/ XT-E | -- |
| -- | -- |
| -- | -- |
| -- | -- |

LL14CR-AOC65150L02

Brightness Illuminance Asymmetrical



DxWxH(mm): 250x60x9.9
FWHM : 65°x150°

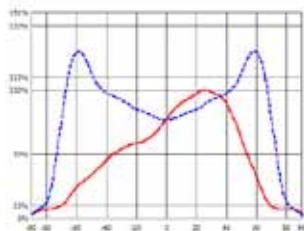

(Type II ,Short)

- | | |
|------|----|
| XT-E | -- |
| -- | -- |
| -- | -- |
| -- | -- |

LL24CR-AU75135L02

Illuminance Asymmetrical

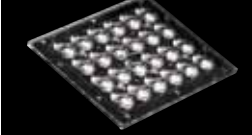

Silicon gasket available
MPCB available
DxWxH(mm): 120x100x10.2
FWHM : 75°x135°

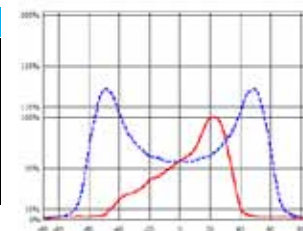

(Type I ,Very Short)

- | | |
|-------------------------|-----------------------|
| XB-D/ XM-L/ XP-G2/ XT-E | Oslon SSL 80 / Square |
| Rebel/ Rebel ES | -- |
| -- | Ceramic 3535 |
| NCS19/ NVS19 | -- |

LL24ED-AU75135L02

Illuminance Asymmetrical

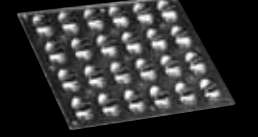

DxWxH(mm): 135x112x9.6
FWHM : 75°x135°

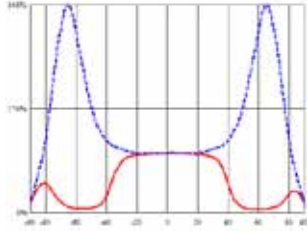

(Type I,Short)

- | | |
|----------------------------|-------------------------------|
| CREE -- | OSRAM -- |
| PHILIPS LUMILEDS -- | SAMSUNG LED -- |
| EDISON 1LA5 | LG Innotek Ceramic3535 |
| NICHIA -- | SEKUL -- |

LL28CR-UI65140L14

Illuminance Asymmetrical

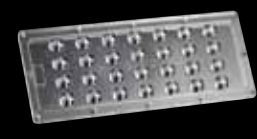

DxWxH(mm): 259.2x79.7x12.2
FWHM : 65°x140°

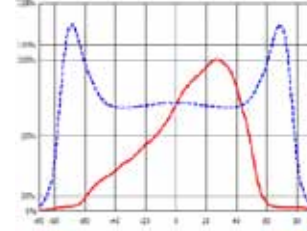

(Type II,Short)

- | | |
|----------------------------------|------------------------------------|
| CREE XP-G2/ XT-E | OSRAM Oslon SSL 80 / Square |
| PHILIPS LUMILEDS Rebel ES | SAMSUNG LED -- |
| EDISON -- | LG Innotek -- |
| NICHIA 383 | SEKUL -- |

LL24LU-JT60120L02

Illuminance Asymmetrical



DxWxH(mm): 126x110x10.5
FWHM : 60°x120°

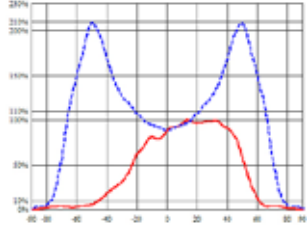

(Type II,Short)

- | | |
|---|-----------------------|
| CREE -- | OSRAM -- |
| PHILIPS LUMILEDS Rebel/ Rebel ES | SAMSUNG LED -- |
| EDISON -- | LG Innotek -- |
| NICHIA -- | SEKUL -- |

LL30CR-PT60140L02

Brightness Illuminance Asymmetrical

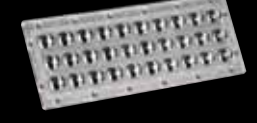

DxWxH(mm): 235x71x9.4
FWHM : 60°x140°

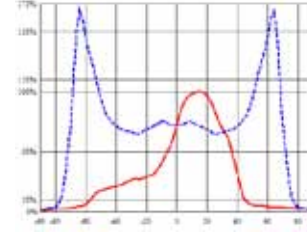

(Type II,Short)

- | | |
|----------------------------------|------------------------------------|
| CREE XP-G2/ XT-E | OSRAM Oslon SSL 80 / Square |
| PHILIPS LUMILEDS Rebel ES | SAMSUNG LED -- |
| EDISON -- | LG Innotek Ceramic 3535 |
| NICHIA 383 | SEKUL -- |

LL24OS-JT110150L02

Illuminance Asymmetrical



DxWxH(mm): 126x110x9
FWHM : 110°x150°

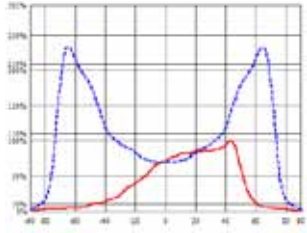

(Type II,Short)

- | | |
|----------------------------|---------------------------|
| CREE -- | OSRAM Oslon SSL 80 |
| PHILIPS LUMILEDS -- | SAMSUNG LED -- |
| EDISON -- | LG Innotek -- |
| NICHIA -- | SEKUL -- |



LENS APPLICATION

Indoor LIGHTING

Multi LIGHTING

DM/DN Series



Part Number	Type	DxH(mm)	FWHM
LL03LU-DMxxL06	3 in 1	23.1x11	15° 25° 40°
LL04LU-DNxxL06	4 in 1	25.4x10.5	

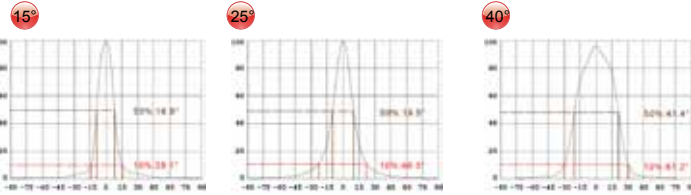

CREE	XPE/XPG
EDISON	Federal
PHILIPS LUMILEDS	Rebel/Luxeon A
NICHIA	NVS19A
OSRAM	Oslon 80
SAMSUNG LED	--
SEoul	Z5

DO Series

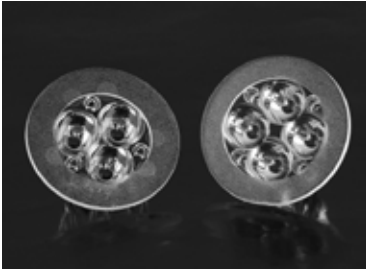

Part Number	Type	DxH(mm)	FWHM
LLxxLU-DOxxL06	3 in 1	35x10.6	15° 25° 40°
	4 in 1	35x10.4	

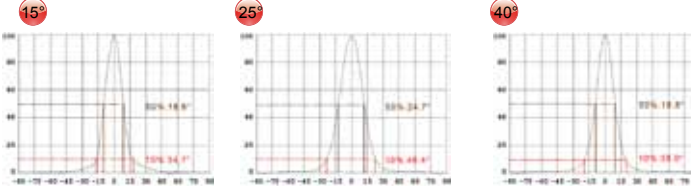

CREE	XPC/XPE/XPG
EDISON	Federal
PHILIPS LUMILEDS	Rebel/Luxeon A
NICHIA	NVS19A
OSRAM	Oslon 80/Square
SAMSUNG LED	--
SEoul	Z5

QQ Series

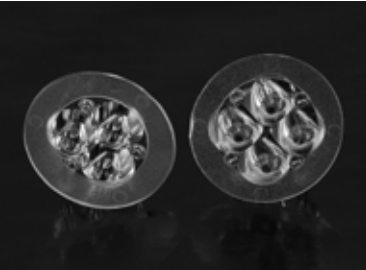

Part Number	Type	DxH(mm)	FWHM
LLxxNI-QQxxL06	3 in 1	35x10.5	15°
	4 in 1	35x10.5	

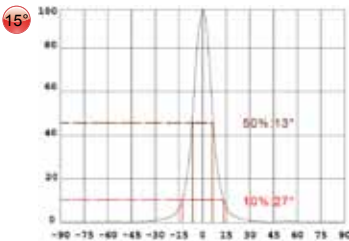

CREE	XPE/XPG
EDISON	Federal 3045
PHILIPS LUMILEDS	Rebel/Rebel Es
NICHIA	NVS19/NCS19/NVS19B
OSRAM	Oslon
SAMSUNG LED	--
SEoul	Z5

RX Series



Part Number	Type	DxH(mm)	FWHM
LLxxCR-RXxxL06	3in1	35x9.6	25° 40° 60°
	4in1	35x9.7	
	6in1	50x9.65	
	7in1	50x10.3	40° 60°
	9in1	70x10.3	
	12in1	70x10.3	

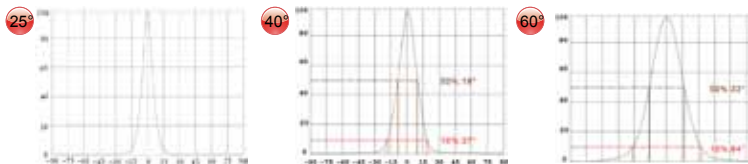

- XTE/XBD/XPE/XPG/XPG2
- Federal 3045/3535
- Rebel/Rebel Es/Luxeon A
- NCS19/NVS19B
- Oslon 80
- Ceramic
-

FR Series

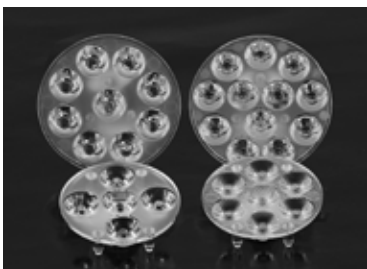

Part Number	Type	DxH(mm)	FWHM
LLxxCR-FRxxL06	5in1	35.8x6.5	25° 40° 60°
	7in1	35.8x6.5	
	9in1	45x7 / 45X6.8(60°)	
	12in1	45x7 / 45X6.8(60°)	

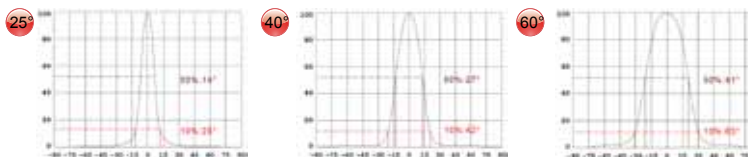

- XPE
- Federal
-
-
-
- Ceramic
-

BFR Series



Part Number	Type	DxH(mm)	FWHM
LLxxCR-BFRxxL06	5in1	35.8x6.3	25° 40° 60°
	7in1		

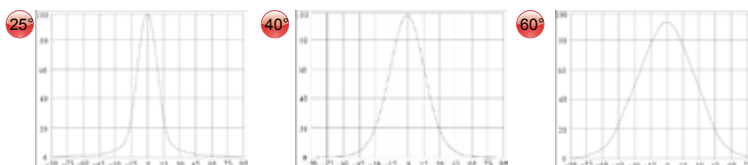

- XT-E
-
-
- NVS19B / 757A
-
-
-

ED-GK Series

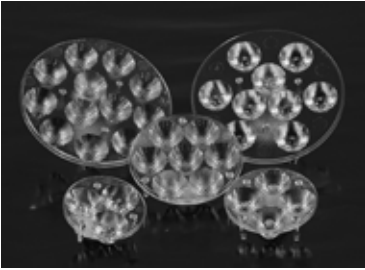

Part Number	Type	DxH(mm)	FWHM
LLxxED-GKxxL06	3in1	33.2x10.2	25° 40° 60°
	4in1	37x10.3	
	7in1	47x10.5 / 47x10.2(25°)	
	9in1	67x10.8 / 67x10.2(25°)	
	12in1	67x10.8 / 67x10.2(25°)	

CREE	XPE/XPG
EDISON	Federal 3045
PHILIPS LUMILEDS	Rebel/Rebel Es
NICHIA	NVS19/NCS19/NVS19B
OSRAM	--
SAMSUNG LED	--
SEOUL	--

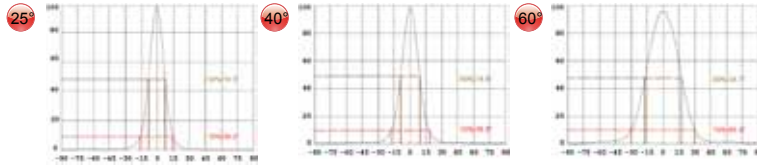

OS-GK Series

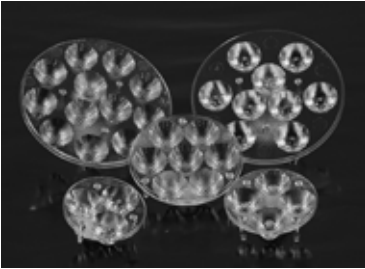

Part Number	Type	DxH(mm)	FWHM
LLxxOS-GKxxL06	3in1	33.2x9.8	25° 40° 60° 80°
	4in1	37x9.8	
	7in1	47x9.8	
	9in1	67x9.8	
	12in1	67x9.8	

CREE	--
EDISON	--
PHILIPS LUMILEDS	LuxeonT
NICHIA	NVS19/NCS19
OSRAM	Oslon 80/Square

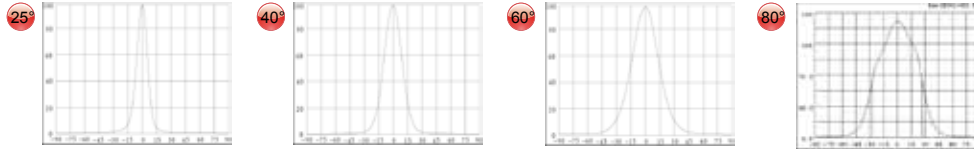

UY Series

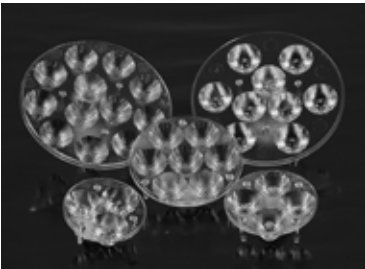

Part Number	Type	DxH(mm)	FWHM
LLxxED-UYxxL06	3in1	33.2x10.3	40° 60°
	4in1	37x10.3	
	7in1	47x10.3	
	9in1	67x10.3	
	12in1	67x10.3	

CREE	XPE/XPG
EDISON	Federal 3045
PHILIPS LUMILEDS	Rebel/Rebel Es
NICHIA	NVS19/NCS19/NVS19B
OSRAM	--
SAMSUNG LED	--
SEOUL	--

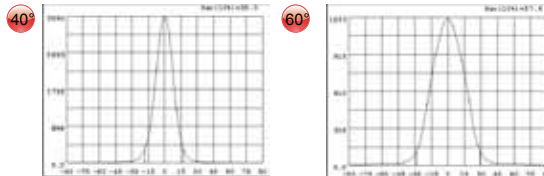



LENS APPLICATION

INDOOR LIGHTING

Flood Lighting

LL03ED-CO 140L



DxH(mm):50x2.9
Full Angle: 140°

EDISON 1LA5 SEDUL P4

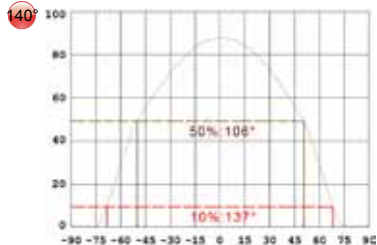

LL03ED-DA 140L



DxH(mm):50x11.2
Full Angle: 140°

EDISON 1LA5 SEDUL P4

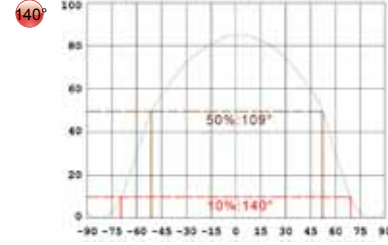

LL06ED-CO 140L-Mx



DxH(mm):73.3x3.2 / 76x16.2(Holder)
Full Angle: 140°

EDISON 1LA5 SEDUL P4

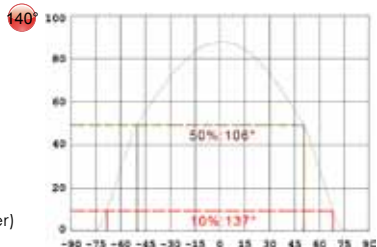

LL06ED-DA 140L-Mx



DxH(mm):73.2x15.9 / 76x28.9(Holder)
Full Angle: 140°

EDISON 1LA5 SEDUL P4

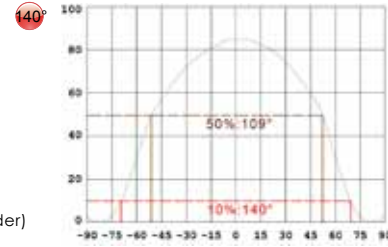

LL09ED-CO 140L-Mx



DxH(mm):90.8x1.5 / 93.9x20.1(Holder)
Full Angle: 140°

EDISON 1LA5 SEDUL P4

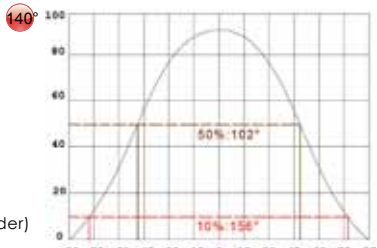

LL09ED-DA 140L-Mx



DxH(mm):90.8x19.5 / 93.9x35.6(Holder)
Full Angle: 140°

EDISON 1LA5 SEDUL P4

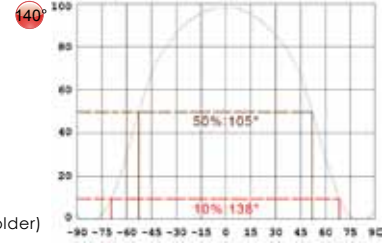

LL12ED-CO 140L-Mx



DxH(mm):90.8x1.5 / 93.9x20.1(Holder)
Full Angle: 140°

EDISON 1LA5 SEDUL P4

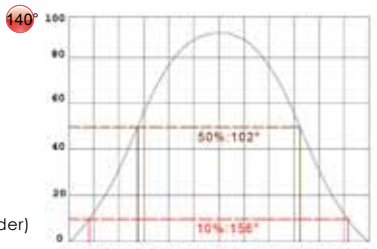

LL12ED-DA 140L-Mx



DxH(mm):90.8x19.5 / 93.9x35.6(Holder)
Full Angle: 140°

EDISON 1LA5 SEDUL P4

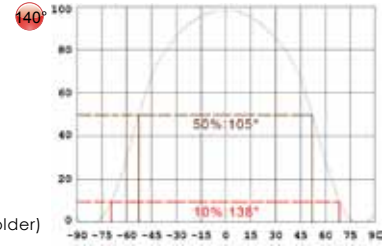



LENS APPLICATION

OUTDOOR LIGHTING

WALLWASHER LIGHTING

LL01CR-DF3065L-Mx

30°x65°



DxH(mm):
11.8x6.5 / 13.5x7.1(Holder)
Full Angle:
30x65°

CREE	XPE/XPG
CITIZEN	--
EDISON	--
PHILIPS LUMILEDS	Rebel
NICHIA	--
OSRAM	--
SAMSUNG LED	--
SEOL	--

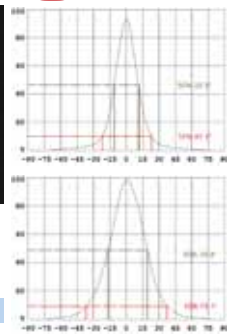

LL01CR-AO2545L-Mx

25°x45°



DxH(mm):
19.4x13.5 / 23.5x15.9(Holder)
Full Angle:
25x45°

CREE	XRE
CITIZEN	--
EDISON	1LA5
PHILIPS LUMILEDS	--
NICHIA	--
OSRAM	--
SAMSUNG LED	--
SEOL	--

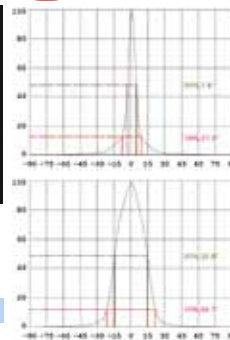

LL01ZZ-FL3065L06-Mx

30°x65°



DxH(mm):
22.2x10.6 / 24.3x11.5(Holder)
Full Angle:
30x65°

CREE	XPE2/XPG2/XML2
CITIZEN	--
EDISON	--
PHILIPS LUMILEDS	--
NICHIA	NVS19B
OSRAM	Oslon Square
SAMSUNG LED	--
SEOL	--

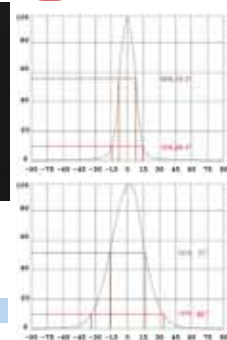

LL01CR-BRxxL-Mx



DxH(mm):
19.6x12.5 / 21.5x13.9(Holder)
Full Angle:
10x45° 15x50° 15x80° 40x90°

CREE	XPE/XPG/XRE/XML2/XPG2
CITIZEN	--
EDISON	Federal/ET-3535
PHILIPS LUMILEDS	Rebel
NICHIA	NCS19/NVS19B
OSRAM	Oslon/Square
SAMSUNG LED	Ceramic3535
SEOL	A4

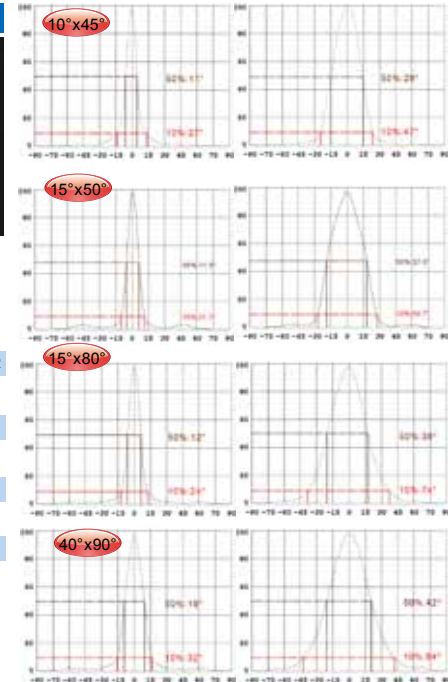

LL01LU-AFCxxL06



DxH(mm):
19.4x17.8
FWHM:
10° 15° 25° 30° 10x35° 15x30°

CREE	XPE/XPE 2/XBD
CITIZEN	--
EDISON	Federal/ET-3535
PHILIPS LUMILEDS	Rebel/Rebel Es/Luxeont
NICHIA	--
OSRAM	Oslon 80/Square
SAMSUNG LED	--
SEOL	--

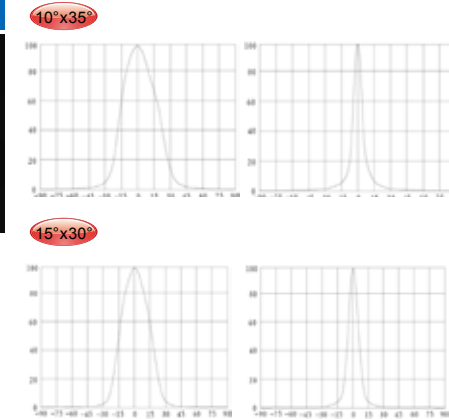

LL01LU-AA2065L-Mx

20°x65°

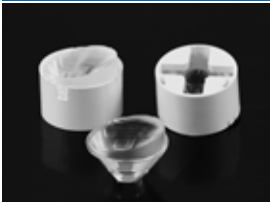

DxH(mm):
19.7x13.8 / 21x16.25(Holder)
Full Angle:
20x65°

-
-
- 1LA5
-
-
-
-
- A4

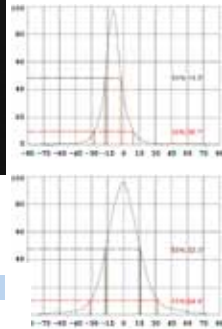

LL01ZZ-EX3065L-Mx

30°x65°



DxH(mm):
34.6x18.7 / 22.4x9.8(Holder)
Full Angle:
30x65°

- XPE/XPG
-
- 1LA5/Federal
- Rebel/Rebel Es
- NCS19/183A/NVS19
- Oslon
- Ceramic
- P4/Z1

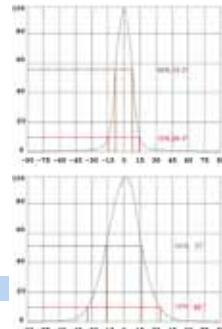

LL01NI-DZ2040L-Mx

20°x40°



DxH(mm):
22x13.9 / 25x18.5(Holder)
Full Angle:
20x40°

-
-
-
-
- 183A
-
-
- A4/P4

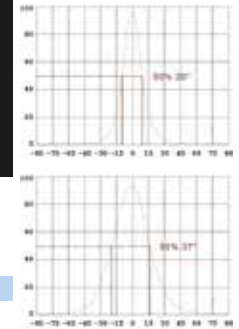

LL01CR-CNExxL06-Mx

10°x45°



DxH(mm):
19.4x15 / 23.5x15.8(Holder)
Full Angle:
10x45° 25x45°

- XP-E2/XP-G2/XT-E
-
- Federal 3535
- Rebel/Rebel ES
-
-
-
-

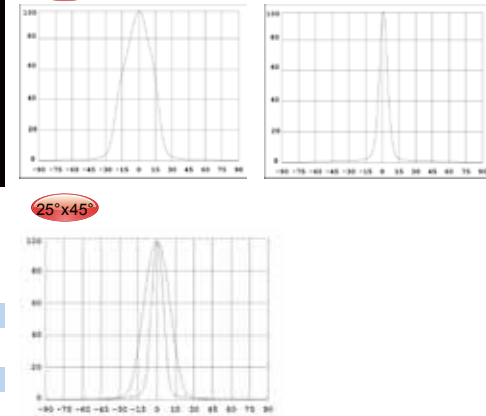

25°x45°

LL01LU-ABW1050L02

10°x50°



DxWxH(mm):
34x29x3
FWHM :
3x50°
For all single chip LED.

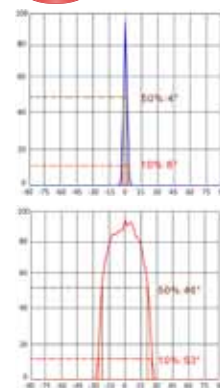



LENS APPLICATION
STAGE LIGHTING

LL01OS-MQxxL06-M2



Full Angle: 15° 25° 40° 60°

- CREE --
- EDISON --
- PHILIPS LUMILEDS --
- NICHIA --
- OSRAM Oslon 80/Square
- SEUL --

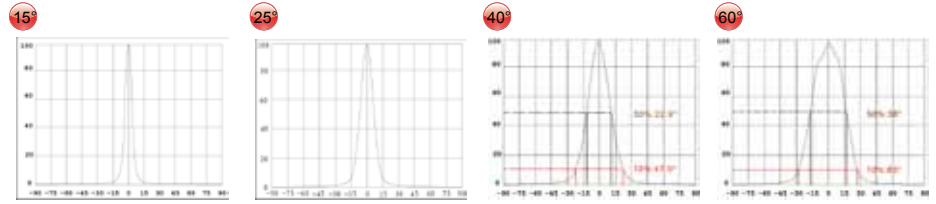

DxH(mm): 21.05x14.75

LL01ED-CVxxL06-M2



FWHM: 15° 25° 45°

- CREE --
- EDISON 1LA5
- PHILIPS LUMILEDS --
- NICHIA --
- OSRAM --
- SEUL --

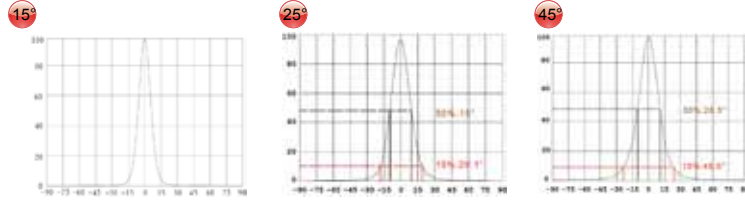

DxH(mm): 21.2x15.1

LL01ED-ALxxL06-M2



FWHM: 15°
Full Angle: 30x65°

- CREE --
- EDISON 1LA5
- PHILIPS LUMILEDS --
- NICHIA --
- OSRAM --
- SEUL --

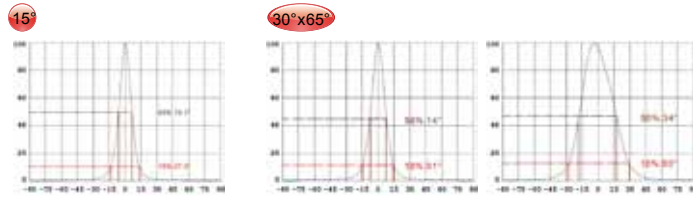

DxH(mm): 21.3x14

LL01ED-ANxxL-M2



Full Angle: 25° 15x50°

- CREE --
- EDISON 1LA5
- PHILIPS LUMILEDS --
- NICHIA --
- OSRAM --
- SEUL --

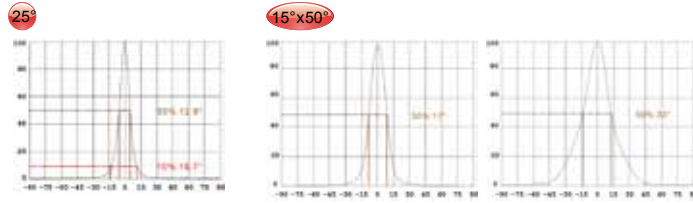

DxH(mm): 25x13.3

LL01ED-AJxxL-M2

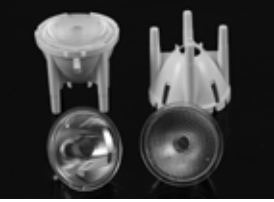

DxH(mm): 31x22.2

Full Angle: 10° 25° 40° 60°

- CREE** MCE color/XML color
- EDISON** Federal 5050 RGBW
- PHILIPS LUMILEDS** --
- NICHIA** --
- OSRAM** Ostar
- SEKON** --

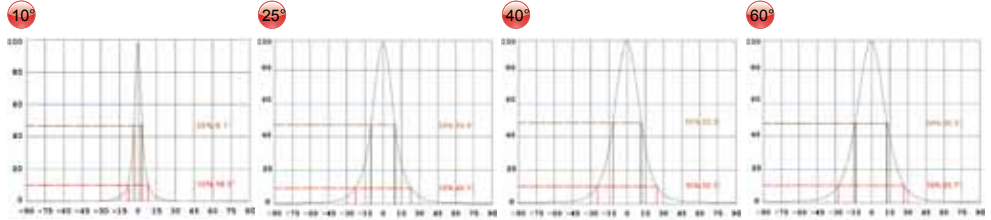

LL01ED-AKxxL06



DxH(mm): 34.4x18.8

Full Angle: 25° 40°

- CREE** MCE color/XML color
- EDISON** Federal color
- PHILIPS LUMILEDS** --
- NICHIA** --
- OSRAM** Ostar SMDcolor
- SEKON** --

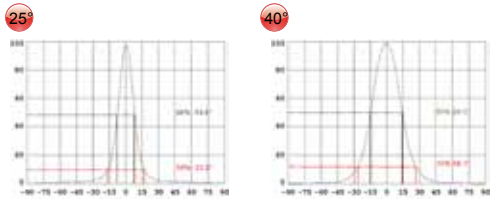

LL01ED-BCQxxL06-M1



DxH(mm): 38.1x20.2

FWHM: 15°
Full Angle: 30x65°

- CREE** XML color
- EDISON** Federal 5050 color
- PHILIPS LUMILEDS** --
- NICHIA** --
- OSRAM** Ostar SMDcolor
- SEKON** --

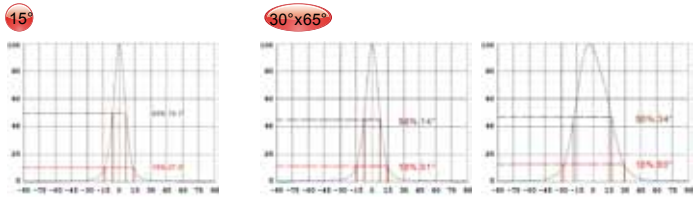

LL01CR-BCQxxL06-M1



DxH(mm): 38.1x20.9

FWHM: 15°
Full Angle: 30x65°

- CREE** MCE color
- EDISON** --
- PHILIPS LUMILEDS** --
- NICHIA** --
- OSRAM** --
- SEKON** --

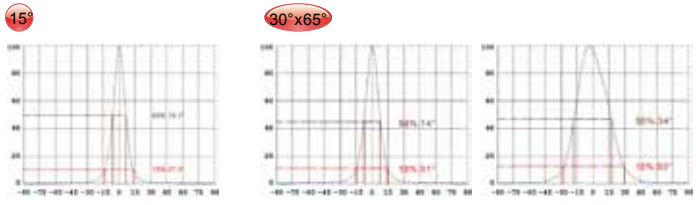

LL01CR-ANWxxL06



FWHM: 10° 20° 30°

CREE	MCE color
EDISON	--
PHILIPS LUMILEDS	--
NICHIA	--
OSRAM	Ostar SMDcolor
SEOLUX	--

10°

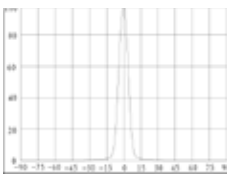

20°

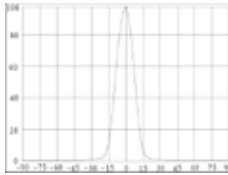

30°

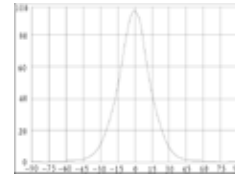

DxH(mm): 45x26.3

LL15ED-BHxxL

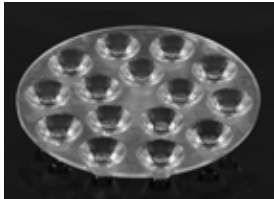

Full Angle: 15° 25° 40°

CREE	XML
EDISON	1LA5
PHILIPS LUMILEDS	--
NICHIA	--
OSRAM	--
SEOLUX	--

15°

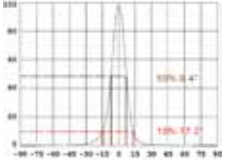

25°

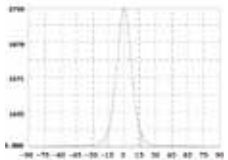

40°

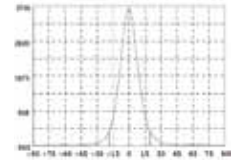

DxH(mm): 95x11.1

LL18ED-BIxxL



Full Angle: 15° 25° 40°

CREE	XPE
EDISON	1LA5
PHILIPS LUMILEDS	--
NICHIA	--
OSRAM	--
SEOLUX	--

15°

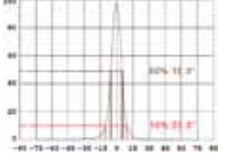

25°

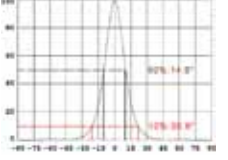

40°

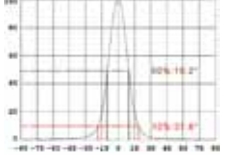

DxH(mm): 110x13.1

LL24ED-ABxxL

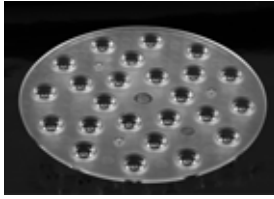

Full Angle: 15° 25° 45°

CREE	XPE
EDISON	1LA5
PHILIPS LUMILEDS	--
NICHIA	--
OSRAM	--
SEOLUX	--

15°

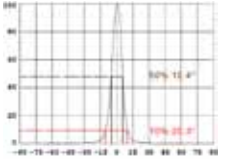

25°

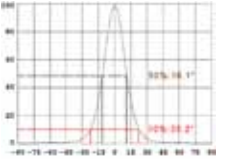

45°

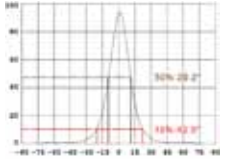

DxH(mm): 174.5x12.5

LL36ED-AAxxL



Full Angle: 15° 25° 45°

CREE	XPE
EDISON	1LA5
PHILIPS LUMILEDS	--
NICHIA	--
OSRAM	--
SEoul	--

15°

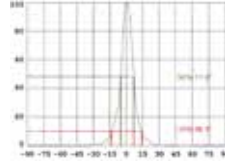

25°

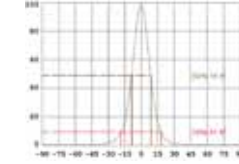

45°

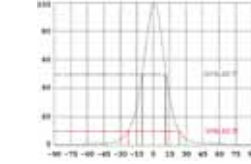

DxH(mm): 140x12.7

LL60ED-BOxxL

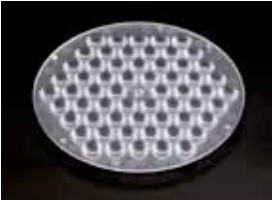

Full Angle: 25° 45°

CREE	XPE
EDISON	1LA5
PHILIPS LUMILEDS	--
NICHIA	--
OSRAM	--
SEoul	--

25°

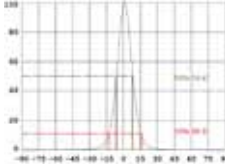

45°

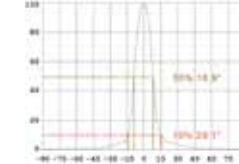

DxH(mm): 180x13.1

Lens list by LED



CREE 



CITIZEN
Micro HumanTech



 **NICHIA**



OSRAM
Opto Semiconductors



 **EDISON**



PHILIPS
LUMILEDS



 **SEOUL**



 **SAMSUNG LED**



SHARP



 **LG Innotek**

Type	Part Number	DxH(mm)	Full Angle	FWHM	Holder
Single	LL01CR-BDFxxL06-M2	13.5 x 7.35	40° 60°		V
	LL01CR-BEXxxL06-M2	22.4 x 9.7	25° 40° 60°		V
	LL01CR-BNExxxL06-M2	23.5x1 5.8	25° 40° 60° 35x70°		V
	LL01CR-BRxxL06	19.65 x 12.5	40°		
	LL01CR-DFxxL06	11.8 x 6.65	80° 100° 30x65°		
	LL01CR-DGxxL06	28.8 x 16.75	20° 30° 40° 50° 60°		
	LL01CR-HQxxL06	14.8 x 9.6	30° 40° 60° 80°		
	LL01CR-NExxL06	19.4 x 15	25° 40° 60° 80° 10x45° 25x45°		
	LL01CR-OTxxL06	15 x 9.7	80°		
	LL01CR-WIxxL02	28.8 x 17.4		25° 40°	
	LL01ED-AJxxL06	28.9 x 19.7	25° 40° 60°		
	LL01ED-AKxxL06	34.4 x 18.8	40°		
	LL01LU-AFCxxL06	19.4 x 11.8	15x60° 20x50°		
	LL01XB-AAFxxL02-M2	13.5 x 7.35		60°	V
	LL01NI-ANExxL02	19.4 x 14.94		20° 30°	
	LL01NI-GRxxL06	19.45 x 13.5	40° 60° 80°		
	LL01OS-HGxxL06	10 x 6	60°		
	LL01OS-MQxxL06	19.45 x 13.7	25° 40° 60°		
	LL01ZZ-AFLxxL02	22.2 x 10.4		35° 50°	
	LL01CR-OSxxL06-M2	22.4x9.13	40° 30x65°		V
LL01ZZ-FLxxL06	22.2 x 10.6	25° 40° 60°			
3 in 1	LL03CR-AZxxL06	50 x 14.5	25° 45°		
	LL03CR-BDOxxL06	35 x 10.8		15° 25°	
	LL03CR-RXxxL06	35 x 9.6	40° 60°		
	LL03ED-UYxxL06	33.2 x 10.3	40°		
	LL03LU-DMxxL06	23.1 x 11		25° 40°	
	LL03LU-DOxxL06	35 x 10.6		25° 40°	
	LL03OS-GKxxL06	33.2 x 9.8	25° 40° 60°		

Type	Part Number	DxH(mm)	Full Angle	FWHM	Holder
4 in 1	LL04CR-RXxxL06	35 x 9.7	25° 40° 60°		
	LL04ED-UYxxL06	37 x 10.3	40°		
	LL04LU-DNxxL06	25.4 x 10.5		25° 40°	
	LL04LU-DOxxL06	35 x 10.4		25° 40°	
	LL04LU-GPxxL06	22.2 x 6.8	45°		
	LL04OS-GKxxL06	37 x 9.8	40° 60°		
5 in 1	LL05CR-BFRxxL06	35.8 x 6.3		40°	
6 in 1	LL06CR-RXxxL06	50 x 9.65	40° 60°		
	LL06CR-AXLxxL06-M2	76 x 13		25°	V
7 in 1	LL07CR-BFRxxL06	35.8 x 6.3		40°	
	LL07CR-RXxxL06	50 x 10.3	40° 60°		
	LL07ED-UYxxL06	47 x 10.3	40°		
	LL07OS-GKxxL06	47 x 9.8	40° 60°		
	LL07ZZ-FUxxL06	50.35 x 10.7		25°	
9 in 1	LL07ZZ-FVxxL02	39.2 x 10.8		30°	
	LL09CR-RXxxL06	70 x 10.3	40° 60°		
	LL09ED-UYxxL06	67 x 10.3	40°		
	LL09OS-GKxxL06	67 x 9.8	40° 60°		
12 in 1	LL09ED-ATxxL06	90.6 x 17.5	40°		
	LL12CR-RXxxL06	70 x 10.3	40° 60°		
	LL12ED-UYxxL06	67 x 10.3	40°		
18 in 1	LL12OS-GKxxL06	67 x 9.8	40° 60°		
	LL18ED-BlxxL06	110 x 13.1	40°		
Street Lighting	LL01CR-APM80150L02	18 x 12.5 x 6.95		80°x150° (Asymmetry)	
	LL01CR-AU85135L02	18 x 10.2 x 6.1		85°x135° (Asymmetry)	
	LL01CR-BAJ85135L02	18 x 12.5 x 6.1		85°x135° (Asymmetry)	
	LL01CR-FT60135L02	18 x 9.3 x 5.9		60°x135° (Symmetry)	
	LL01CR-OG85150L02	18 x 8.95 x 6.2		85°x150° (Symmetry)	
	LL01CR-OW70130L02	17.4 x 12.75 x 7.2		70°x130° (Asymmetry)	
	LL01CR-PB70140L02	22.4 x 11.4 x 6.9		70°x140° (Asymmetry)	
	LL01LU-UQ70140L02	18 x 11 x 6.6		70°x140° (Asymmetry)	
	LL24CR-AU75135L02	120 x 100 x 10.2		75°x135° (Asymmetry)	



■ XPE/ XPE2

Type	Part Number	DxH(mm)	Full Angle	FWHM	Holder
Single	LL01CR-ABGxxL02	34 x 15.7		24°	
	LL01CR-ACZxxL02	27.8 x 10.2		24° 38°	
	LL01CR-CRxxL06-M2	13.55x7.25	40° 60°		V
	LL01CR-BEXxxL06	20.9 x 9.2	40° 60°		
	LL01CR-BNExxL06	19.4 x 14.6	40° 35x70°		
	LL01CR-BRxxL06	19.65x12.5	40° 10x45° 15x50° 15x80° 40x90°		
	LL01CR-DFxxL02-M2	13.5 x 7.35	25° 40° 80° 100° 30x65°		V
	LL01XP-DGxxL06-M2	32.8x18	20° 30° 40° 50° 60°		V
	LL01CR-HQxxL06-M2	16 x 10.3	15° 25° 30° 40° 60° 80° 25x45°		V
	LL01CR-NExxL06-M2	23.5 x 15.8	15° 17° 25° 40° 60° 80° 10x45° 25x45°		V
	LL01CR-OTxxL06-M2	16.6x 10.45	25° 40° 60° 80°		V
	LL01CR-SQxxL06	19.4 x 12.9	40° 60°		
	LL01CR-WLxxL02	28.8 x 16.7		15° 25° 40°	
	LL01CR-YJxxL02	19.4 x 12.6	40° 60°		
	LL01ED-ACZxxL02	35 x 10.7		24° 38°	
	LL01ED-AJxxL06	28.9 x 19.7	25° 40° 60°		
	LL01ED-ALxxL06	19.65 x 11.4	15° 30x65°		
	LL01ED-ANxxL06	22.7 x 9.6	15°x50°		
	LL01ED-CTxxL06	31 x 11.2	38° 80°		
	LL01CR-AFCxxL06-M2	21.3 x 12.4		10° 15° 25° 30° 10x35° 15x30°	V
	LL01CR-AAFxxL02-M2	13.5 x 7.35		25°	V
	LL01NI-ANExxL02-M2	23.5 x 15.8		10° 20° 30°	V
	LL01NI-GRxxL06	19.45 x 13.5	25° 40° 60° 80°		
	LL01OS-AXxxL02	20 x 11.5	20° 40° 60°		
LL01OS-MQxxL06	19.45 x 13.7	25° 40° 60°			
LL01ZZ-EXxxL06-M2	22.4 x 9.7	10° 25° 40° 60° 30x65°		V	
LL01XP-FLxxL06-M2	24.3 x 11.5	10° 25° 40° 60° 30x65°		V	
LL01LU-AAxxL06	19.7 x 13.8	20°x65°			
LL01LU-LHxxL06	21 x 9.15	15°			
LL01ZZ-AHAXxxL06	50 x 25.4		5°		

Type	Part Number	DxH(mm)	Full Angle	FWHM	Holder
Single	LL01CR-XSxxL06	22.2x10.6	40°		
	LL01ED-AKxxL06	34.4x18.8	40°		
	LL01OS-BWxxL06	37.2x15.35	30°		
	LL01OS-BYxxL06	37.2x15.35	30°		
	LL01ED-FMxxL06	19.9x10.55	38°		
	LL01OS-CBxxL06	25.6x10		15°	
	LL01CR-AVC30L	28.8 x 15.95		30°	V
	LL01CR-ADI10L06	20 x 18.5		10°	
	LL01OS-BFVxxL06	20.8 x 12.35		15° 25° 30° 10°x40°	
	LL01CR-BLU03L06	35 x 20		3°	
	LL03CR-AZxxL06	50 x 14.5	25° 45° 60°		
	LL03CR-RXxxL06	35 x 9.6	25° 40° 60°		
3 in 1	LL03ED-AZxxL06	50.5 x 13	45°		
	LL03ED-UYxxL06	33.2 x 10.3	40°		
	LL03LU-DMxxL06	23.1 x 11		15° 25° 40°	
	LL03LU-DOxxL06	35 x 10.6		15° 25° 40°	
	LL03OS-GKxxL06	33.2 x 9.8	25° 40° 60°		
	LL04CR-ABDxxL06	22 x 6.7		24° 36°	
4 in 1	LL04CR-GPxxL06	22.2 x 6.7	25° 38° 45°		
	LL04CR-RXxxL06	35 x 9.7	25° 40° 60°		
	LL04ED-UYxxL06	37 x 10.3	40°		
	LL04LU-DNxxL06	25.4 x 10.5		15° 25° 40°	
	LL04LU-DOxxL06	35 x 10.4		15° 25° 40°	
	LL04LU-GPxxL06	22.2 x 6.8	45°		
5 in 1	LL04ED-EXxxL06	25.4 x 10.4	60°		
	LL04ZZ-EXxxL06	25.4 x 10.4	30°		
	LL05CR-FRxxL06	35.8 x 6.5	25° 40° 60°		
6 in 1	LL06CR-AXNxxL06-M2	76 x 13		25°	V
	LL06CR-RXxxL06	50 x 9.65	25° 40° 60°		
	LL06ED-ADxxL06	73.3 x 11.5	25° 40° 60°		
	LL06CR-AXMxxL06-M2	76 x 13		15° 25° 35°	V
	LL06CY-TTxxL06	73.3 x 16	45°		
LL06CR-AXLxxL06-M2	76 x 13		25°	V	



XPE



XPE2



Type	Part Number	DxH(mm)	Full Angle	FWHM	Holder
7 in 1	LL07CR-FRxxL06	35.8 x 6.5	25° 40° 60°		
	LL07CR-RXxxL06	50 x 10.3	40° 60°		
	LL07ED-UYxxL06	47 x 10.3	40°		
	LL07ZZ-FUxxL06	50.35 x 10.7		15° 25°	
	LL07ZZ-FVxxL06	39.2 x 10.6		15° 25°	
9 in 1	LL09CR-FRxxL06	45 x 7	25° 40° 60°		
	LL09CR-RXxxL06	70 x 10.3	40° 60°		
	LL09ED-UYxxL06	67 x 10.3	40°		
	LL09CY-TTxxL06	90.6 x 18.8	45°		
12 in 1	LL12CR-FRxxL06	45 x 7	25° 40° 60°		
	LL12CR-RXxxL06	70 x 10.3	40° 60°		
	LL12ED-UYxxL06	67 x 10.3	40°		
	LL12OS-GKxxL06	67 x 9.8	40° 60°		
24 in 1	LL24CR-PFxxL02	113.6 x 76 x 9	15°		
	LL24CR-VExxL02	99 x 90 x 10.3	15°		

Type	Part Number	DxH(mm)	Full Angle	FWHM	Holder	
Street Lighting	LL01CR-AU85135L02	18 x 10.2 x 6.1		85°x135° (Asymmetry)		
	LL01CR-BAJ85135L02	18 x 12.5 x 6.1		85°x135° (Asymmetry)		
	LL01CR-DL70130L02	26 x 12.7 x 8.65		70°x130° (Asymmetry)		
	LL01CR-DL90120L02	26 x 15.8 x 9.15		90°x120° (Asymmetry)		
	LL01CR-FT60135L02	18 x 9.3 x 5.9		60°x135° (Symmetry)		
	LL01CR-KM6090L02	17.55 x 11.6 x 8.6		60°x90° (Symmetry)		
	LL01CR-OG85150L02	18 x 8.95 x 6.2		85°x135° (Symmetry)		
	LL01CR-OW70130L02	17.4 x 12.75 x 7.2		70°x130° (Asymmetry)		
	LL01CR-PB70140L02	22.4 x 11.4 x 6.9		70°x140° (Asymmetry)		
	LL01LU-NI75140L02	15.7 x 14 x 5.8		75°x140° (Asymmetry)		
	LL01LU-UQ70140L02	18 x 11 x 6.6		70°x140° (Asymmetry)		
	LL01OS-AU60130L02	30.1 x 14.3 x 8.5		60°x130° (Symmetry)		
	LL01OS-AU60140L02	16 x 8.8 x 5.3		60°x140° (Asymmetry)		
	LL01ZZ-AGX45155L02	18 x 12.5 x 7		45°x155° (Asymmetry)		
	LL20CR-VK60140L02	319.3 x 52.3 x 14.6		60°x140° (Asymmetry)		
	LL24CR-AU75135L02	120 x 100 x 10.2		75°x135° (Asymmetry)		
	LL28CR-UI65140L14	259.2 x 79.7 x 12.2		65°x140° (Asymmetry)		
	LL30CR-PT60140L02	235 x 71 x 9.4		60°x140° (Asymmetry)		
	Reflector	LL01CR-YNxxL08-P	19 x 15.3		10° 20°	



XPE



XPE2



■ XPG / XPG2

Type	Part Number	DxH(mm)	Full Angle	FWHM	Holder	Type	Part Number	DxH(mm)	Full Angle	FWHM	Holder		
Single	LL01CR-BEXxL06	20.9 x 9.2	25° 40° 60°			3 in 1	LL03CR-AZxxL06	50 x 14.5	25° 45° 60°				
	LL01CR-BRxxL06	19.65 x 12.5	40° 15°x80° 40°x90°				LL03CR-RXxxL06	35 x 9.6	25° 40° 60°				
	LL01CR-DFxxL02-M2	13.5x7.35	25° 40° 60° 80° 100° 30x65°		V		LL03ED-UYxxL06	33.2 x 10.3	40°				
	LL01XP-DGxxL06-M2	32.8x18	20° 30° 40° 50° 60°		V		LL03LU-DMxxL06	23.1 x 11		15° 25° 40°			
	LL01CR-HQxxL06-M2	16x10.3	15° 25° 30° 40° 60° 80° 25x45°		V		LL03LU-DOxxL06	35 x 10.6		15° 25° 40°			
	LL01CR-NExxL06-M2	23.5x15.8	15° 25° 40° 60° 80° 10 x45° 25x45°		V		LL03OS-GKxxL06	33.2 x 9.8	25° 40° 60°				
	LL01CR-OTxxL06-M2	16.6x10.45	25° 40° 60° 80°		V		4 in 1	LL04CR-RXxxL06	35 x 9.7	25° 40° 60°			
	LL01CR-SQxxL06	19.4 x 12.9	40° 60°					LL04ED-UYxxL06	37 x 10.3	40°			
	LL01CR-YJxxL02	19.4 x 12.6	40° 60°					LL04LU-DNxxL06	25.4 x 10.5		15° 25° 40°		
	LL01ED-AJxxL06	28.9 x 19.7	40° 60°					LL04LU-DOxxL06	35 x 10.4		15° 25° 40°		
	LL01ED-AKxxL06	34.4 x 18.8	25° 40°				5 in 1	LL05CR-FRxxL06	35.8 x 6.5	25° 40° 60°			
	LL01CR-AAFxxL02-M2	13.5x7.35			25°		V	6 in 1	LL06CR-RXxxL06	50 x 9.65	25° 40° 60°		
	LL01HS-AAFxxL02-M2	13.5x7.35			45°	V	LL06ED-ADxxL06		73.3 x 11.5	25° 40° 60°			
	LL01NI-ANExxL02-M2	23.5x15.8			10° 20° 30°	V	LL06CR-AXMxxL06-M2		76 x 13		15° 25° 35°	V	
	LL01NI-GRxxL06	19.45 x 13.5		40° 60° 80°			7 in 1	LL07CR-FRxxL06	35.8 x 6.5	25° 40° 60°			
	LL01OS-AXxxL02	20 x 11.5		40°				LL07CR-RXxxL06	50 x 10.3	40° 60°			
	LL01OS-MQxxL06	19.45 x 13.7		25° 40° 60°				LL07ED-UYxxL06	47 x 10.3	40°			
	LL01ZZ-EXxxL06-M2	22.4 x 9.7		10° 25° 40° 60° 30x65°		V		LL07ZZ-FUxxL06	50.35 x 10.7		15° 25°		
	LL01XP-FLxxL06-M2	24.3 x 11.5		10° 25° 40° 60° 30x65°		V		LL07ZZ-FVxxL06	39.2 x 10.6		15° 25°		
	LL01ZZ-AHAxxL06	50 x 25.4			5°		9 in 1	LL09CR-RXxxL06	70 x 10.3	40° 60°			
	LL01CR-CRxxL06-M2	13.55x7.25		40° 60°		V		LL09ED-UYxxL06	67 x 10.3	40°			
	LL01CR-BMxxL06	35.8x15.85		40°				12 in 1	LL12CR-FRxxL06	45 x 7	25° 40° 60°		
	LL01CR-BNExxL06	19.4x14.6		25° 40° 60°			LL12CR-RXxxL06		70 x 10.3	40° 60°			
	LL01CR-WbxxL02	28.8x17.4			15° 25° 40°		LL12ED-AGxxL06		112 x 13.4	45°			
	LL01CR-XSxxL06	22.2x10.6		40°			LL12ED-BGxxL06		95 x 11.2	40°			
	LL01ED-ANxxL06	22.7x9.6		15x50°			LL12ED-UYxxL06		67 x 10.3	40°			
	LL01ED-AOxxL06	19.4x13.5		60° 80°			LL12OS-GKxxL06		67 x 9.8	40° 60°			
	LL01ED-AQxxL06	22.5x10.45		40°			24 in 1		LL24CR-PFxxL02	113.6 x 76 x 9	15°		
	LL01ED-ASxxR06	19.9x10.55		38° 60°					LL24CR-VExxL02	99 x 90 x 10.3	15°		
	LL01OS-BWxxL06	37.2x15.35		30°									
	LL01OS-BYxxL06	37.2x15.35		30°									



XPG



XPG2



■ XPG/XPG2

Type	Part Number	DxH(mm)	Full Angle	FWHM	Holder
Street Lighting	LL01CR-APM80150L02	18 x 12.5 x 6.95		80°x150° (Asymmetry)	
	LL01CR-AU85135L02	18 x 10.2 x 6.1		85°x135° (Asymmetry)	
	LL01CR-BAJ85135L02	18 x 12.5 x 6.1		85°x135° (Asymmetry)	
	LL01CR-DL70130L02	26 x 12.7 x 8.65		70°x130° (Asymmetry)	
	LL01CR-DL90120L02	26 x 15.8 x 9.15		90°x120° (Asymmetry)	
	LL01CR-FT60135L02	18 x 9.3 x 5.9		60°x135° (Symmetry)	
	LL01CR-KM6090L02	17.55 x 11.6 x 8.6		60°x90° (Symmetry)	
	LL01CR-OG85150L02	18 x 8.95 x 6.2		85°x150° (Symmetry)	
	LL01CR-OW70130L02	17.4 x 12.75 x 7.2		70°x130° (Asymmetry)	
	LL01CR-PB70140L02	22.4 x 11.4 x 6.9		70°x140° (Asymmetry)	
	LL01LU-AEV50150L02	18 x 12.5 x 6.3		50°x150° (Asymmetry)	
	LL01LU-AIK45135L02	18 x 12.5 x 7.05		45°x135° (Asymmetry)	
	LL01LU-NI75140L02	15.7 x 14 x 5.8		75°x140° (Asymmetry)	
	LL01LU-UQ70140L02	18 x 11 x 6.6		70°x140° (Asymmetry)	
	LL01OS-AU60130L02	30.1 x 14.3 x 8.5		60°x130° (Symmetry)	
	LL01OS-AU60140L02	16 x 8.8 x 5.3		60°x140° (Asymmetry)	
	LL01ZZ-AGX45155L02	18 x 12.5 x 7		45°x155° (Asymmetry)	
LL20CR-VK60140L02	319.3 x 52.3 x 14.6		60°x140° (Asymmetry)		
LL24CR-AU75135L02	120 x 100 x 10.2		75°x135° (Asymmetry)		
LL28CR-UI65140L14	259.2 x 79.7 x 12.2		65°x140° (Asymmetry)		
LL30CR-PT60140L02	235 x 71 x 9.4		60°x140° (Asymmetry)		
Reflector	LL01CR-YNxxL08-P	19 x 15.3		10° 20°	

■ MX3/ MX6

Type	Part Number	DxH(mm)	Full Angle	FWHM	Holder
Single	LL01CR-BRxxL06	19.65 x 12.5	40°		
	LL01CR-DGxxL06	28.8 x 16.65	30° 40° 60°		
	LL01CR-WlxxL02	28.8 x 17.4		25° 40°	
	LL01CR-ZExxL02	35 x 20.4	20° 45°		
	LL01ED-AJxxL06	28.9 x 19.7	25° 40° 60°		
	LL01ED-AKxxL06	34.4 x 18.8	25° 40°		
	LL01ED-ASxxL06	19.9 x 10.15	60°		
	LL01ED-BBxxL06	35.8 x 16.5	60°		
	LL01ED-CTxxL06	31 x 11.2	38° 80°		
	LL01ED-CVxxL06	19.6 x 12.3	45°		
	LL01NI-AAFxxL02-M2	13.5 x 7.35		45°	V
	LL01NI-GRxxL06-M2	23.5 x 14.9	40°		V
	LL01OS-AXxxL02	20 x 11.5	40° 60°		
	LL01OS-BWxxL06	37.2 x 15.35	30°		
	LL01OS-BYxxL06	37.2 x 15.35	30°		
	LL01ZZ-EXxxL06	21 x 9.3	25° 40°		
	LL01ZZ-FLxxL06	22.2 x 10.6	10° 25° 40° 60°		
	LL01ED-FMxxL06	19.9 x 10.55	38°		
	LL01OS-CBxxL06	25.6 x 10	15°		
	LL01CR-ABGxxL02	34 x 15.7		24°	
	LL01CR-BSxxL06	19.8 x 12.5	60°		
	LL01CR-SQxxL06	19.4 x 12.9	40° 60° 80°		
	LL01CR-AAFxxL02-M2	13.5 x 7.35		25°	V
	LL01ED-BVxxL06	19.9 x 10.7	60°		
	LL03CR-EKxxL06	35 x 9	40° 60°		
	LL03ED-AZxxL06	50.5 x 13	45°		
	LL03ED-BAxxL06	50.5 x 13	45° 60°		
	LL03ED-CTxxL06	31 x 11.2	38°		
	LL03CR-CExxL06	34 x 9.9	38°		
	LL03ED-AFxxL06	50.5 x 20	45° 60°		
	LL03CR-HKxxL06	35 x 8.2	40°		
	LL03ZZ-EUxxL06	33 x 6.9	38°		
6 in 1	LL06CR-AXMxxL06-M2	76 x 13		25°	V
	LL06CR-AXLxxL06-M2	76 x 13		25°	V
	LL06CR-AXNxxL06-M2	76 x 13		25°	V
9 in 1	LL09ED-ATxxL06	90.6 x 17.5	40°		
12 in 1	LL12ED-AGxxL06	112 x 13.4	45°		
	LL12ED-BGxxL06	95 x 11.2	40°		
15 in 1	LL15ED-BHxxL06	95 x 11.1	40°		
18 in 1	LL18ED-BlxxL06	110 x 13.1	40°		
24 in 1	LL24ED-ABxxL06	174.5 x 12.7	45°		
36 in 1	LL36ED-AAxxL06	140 x 12.6	45°		
60 in 1	LL60ED-BOxxL06	180 x 13.1	25°		
Street Lighting	LL01OS-AU60130L02	30.1 x 14.3 x 8.5		60°x130° (Symmetry)	



**MX3
MX6**



XTE



XTE



Type	Part Number	DxH(mm)	Full Angle	FWHM	Holder
Single	LL01CR-AAFxxL02-M2	13.5 x 7.35		25°	V
	LL01CR-BRxxL06	19.65 x 12.5	40°		
	LL01CR-DFxxL02-M2	13.5 x 7.35	80° 100°		V
	LL01XP-DGxxL06-M2	32.8 x 18	30° 50° 60°		V
	LL01CR-HQxxL06-M2	16 x 10.3	40° 60° 80°		V
	LL01CR-NExxL06-M2	23.5 x 15.8	25° 40° 60° 80° 25 x45°		V
	LL01CR-OTxxL06-M2	16.6 x 10.45	80°		V
	LL01CR-SQxxL06	19.4 x 12.9	40° 60°		
	LL01CR-WlxxL02	28.8 x 17.4		25° 40°	
	LL01ED-AKxxL06	34.4x18.8	25°		
	LL01ED-AJxxL06	28.9 x 19.7	25° 40° 60°		
	LL01ED-ASxxR06	19.9x10.55	38° 60°		
	LL01HS-AAFxxL02-M2	13.5x7.35		45° 60°	V
	LL01NI-ANExxxL02-M2	23.5 x 15.8		10° 20° 30°	V
	LL01NI-GRxxL06	19.45 x 13.5	40° 80°		
	LL01OS-BYxxL06	37.2 x 15.35	30°		
	LL01OS-MQxxL06	19.45 x 13.7	25° 40° 60°		
	LL01ZZ-EXxxL06-M2	22.4 x 9.7	40° 60°		V
	LL01XP-FLxxL06-M2	24.3x11.5	25° 40° 60° 30x65°		V
	LL01CR-XSxxL06	22.2x10.6	40°		
LL01OS-CBxxL06	25.6 x 10		15°		
3 in 1	LL03CR-AZxxL06	50 x 14.5	25° 45°		
	LL03CR-RXxxL06	35 x 9.6	40° 60°		
	LL03ED-ASxxL06	37.7 x 10.5	38°		
	LL03ED-CTxxL06	31 x 11.2	38°		
	LL03ED-UYxxL06	33.2 x 10.3	40°		
	LL03LU-DOxxL06	35 x 10.6		25° 40°	
	LL03OS-GKxxL06	33.2 x 9.8	25° 40° 60°		
	LL03CR-CExxL06	34 x 9.9	38°		

Type	Part Number	DxH(mm)	Full Angle	FWHM	Holder
4 in 1	LL04CR-RXxxL06	35 x 9.7	40° 60°		
	LL04ED-UYxxL06	37 x 10.3	40°		
	LL04LU-DNxxL06	25.4 x 10.5		25° 40°	
	LL04LU-DOxxL06	35 x 10.4		25° 40°	
5 in 1	LL05CR-BFRxxL06	35.8 x 6.3		25° 40° 60°	
6 in 1	LL06CR-RXxxL06	50 x 9.65	40° 60°		
	LL06CY-TTxxL06	73.3 x 16	45°		
7 in 1	LL07CR-BFRxxL06	35.8 x 6.3		25° 40° 60°	
	LL07CR-RXxxL06	50 x 10.3	40° 60°		
	LL07ED-UYxxL06	47 x 10.3	40°		
	LL07ZZ-FVxxL06	39.2 x 10.6	30° 60°	25°	
9 in 1	LL09CR-RXxxL06	70 x 10.3	40° 60°		
	LL09ED-UYxxL06	67 x 10.3	40°		
	LL09CY-TTxxL06	90.6 x 18.8	45°		
12 in 1	LL12CR-RXxxL06	70 x 10.3	40° 60°		
	LL12ED-UYxxL06	67 x 10.3	40°		
15 in 1	LL15ED-BHxxL06	95 x 11.1	40°		
18 in 1	LL18ED-BLxxL06	110 x 13.1	40°		
24 in 1	LL24ED-ABxxL06	174.5 x 12.7	45°		
36 in 1	LL36ED-AAxxL06	140 x 12.6	45°		
Street Lighting	LL01CR-APM80150L02	18 x 12.5 x 6.95		80° x150° (Asymmetry)	
	LL01CR-BAJ85135L02	18 x 12.5 x 6.1		85° x135° (Asymmetry)	
	LL01CR-OW70130L02	17.4 x 12.75 x 7.2		70° x130° (Asymmetry)	
	LL01CR-PB70140L02	22.4 x 11.4 x 6.9		70° x140° (Asymmetry)	
	LL01LU-UQ70140L02	18 x 11 x 6.6		70° x140° (Asymmetry)	
	LL14CR-AOC65150L02	250 x 60 x 9.9		65° x150° (Asymmetry)	
	LL24CR-AU75135L02	120 x 100 x 10.2		75° x135° (Asymmetry)	
	LL28CR-UI65140L14	259.2 x 79.7 x 12.2		65° x140° (Asymmetry)	
	LL30CR-PT60140L02	235 x 71 x 9.4		60° x140° (Asymmetry)	

■ XML

Type	Part Number	DxH(mm)	Full Angle	FWHM	Holder
Single	LL01CR-ABGxxL02	34 x 15.7		24° 55°	
	LL01CR-ACZxxL02	27.8 x 10.2		24° 38°	
	LL01ED-ABYxxL02	44 x 14.1		24°	
	LL01CR-BRxxL06	19.65 x 12.5	40° 10x45° 15x50° 15x80° 40x90°		
	LL01CR-ADGxxL06-M2	32.8 x 18	20° 30° 40° 50° 60°		V
	LL01CR-PVxxL02	45 x 23.7	45° 60° 80°		
	LL01CR-SQxxL06-M2	19.4 x 12.9	40° 60° 80°		V
	LL01CR-WlxxL02-M2	28.8 x 17.4		15° 25° 40°	V
	LL01CR-XSxxL06	22.2 x 10.6	40°		
	LL01CR-YJxxL02-M2	19.4 x 12.7	40° 60° 80° 100°		V
	LL01ED-ACZxxL02	35 x 10.7		24° 38°	
	LL01ED-AJxxL06	28.9 x 19.7	25° 40° 60°		
	LL01ED-CVxxL06	19.6 x 12.3	45°	15° 25°	
	LL01NI-GRxxL06	19.45 x 13.5	25° 40° 60° 80°		
	LL01ZZ-AFLxxL02	22.2 x 10.4		35° 50°	
	LL01ZZ-EXxxL06	21 x 9.15	10° 40° 110° 30x65°		
	LL01ZZ-FLxxL06	22.2 x 10.6	10° 40° 30 x65°		
	LL01OS-CBxxL06	25.6 x 10	15°		
	LL01ZZ-AHA05L06-M2	50 x 25.4		5°	V
	6 in 1	LL01CR-BJH10L06	45 x 26.3		10°
LL06CR-AXNxxL06-M2		76 x 13		25°	V
LL06ED-ADxxL06		73.3 x 11.5	25° 40°		
LL06CR-AXMxxL06-M2		76 x 13		15° 25° 35°	V
9 in 1	LL06CR-AXLxxL06-M2	76 x 13		25°	V
	LL09ED-BZxxL06	90.75 x 16.5	25°		
	LL09ED-ATxxL06	90.6 x 17.5	40°		
Street Lighting	LL09ED-BQxxL06	90.6 x 16.5	25° 60°		
	LL01CR-XW70140L02	32 x 17.6 x 9.8		70° x140° (Asymmetry)	
	LL01LU-AGV80150L02	32 x 18.5 x 9.5		80° x150° (Asymmetry)	
	LL24CR-AU75135L02	120 x 100 x 10.2		75° x135° (Asymmetry)	

■ XML 2

Type	Part Number	DxH(mm)	Full Angle	FWHM	Holder
Single	LL01CR-ABGxxL02	34 x 15.7		24° 38°	
	LL01CR-ACZxxL02	27.8 x 10.2		24° 38°	
	LL01CR-BMxxL06	35.8 x 15.85	40°		
	LL01CR-BRxx3L06	19.65 x 12.5	40° 10x45° 15x50° 15x80° 40x90°		
	LL01CR-BSxxL06	19.8 x 12.5	60°		
	LL01CR-DGxxL06	28.8 x 16.75	20° 30° 40° 50° 60°		
	LL01CR-NExxL06	19.4 x 14.9	15° 80° 10x45°		
	LL01CR-PVxxL02	45 x 23.7	45° 60° 80°		
	LL01CR-SQxxL06	19.4 x 12.9	40° 60° 80°		
	LL01CR-WlxxL02	28.8 x 17.4		15° 25° 40°	
	LL01CR-XSxxL06	22.2 x 10.6	40°		
	LL01CR-ZExxL02	35 x 20.4		20°	
	LL01ED-ACZxxL02	35 x 10.7		24° 38°	
	LL01ED-AFDxxL06	26 x 15.3		20°	
	LL01ED-AJxxL06	28.9 x 19.7	25° 40° 60°		
	LL01ED-AKxxL06	34.4 x 18.8	25° 40°		
	LL01ED-ALxxL06	19.7 x 9.9	30x65°		
	LL01ED-ANxxL06	22.7 x 9.6	15°x50°		
	LL01ED-AOxxL06	19.4 x 13.45	60°		
	LL01ED-AQxxL06	22.5 x 10.45	40° 60°		
	LL01ED-ASxxL06	19.9 x 10.15	60°		
	LL01ED-AYxxL06	43.8 x 24.5	38°	10°	
	LL01ED-CYxxL06	26.8 x 18.9	30° 45°		
	LL01LU-AFCxxL06	19.4 x 11.8		15x60° 20x50°	
	LL01NI-GRxxL06	19.45 x 13.5	25° 40° 60° 80°		
	LL01OS-AXxxL02	20 x 11.5	20° 40° 60°		
	LL01OS-BWxxL06	37.2 x 15.35	30°		
	LL01OS-BYxxL06	37.2 x 15.35	30°		
	LL01ZZ-AHZxxL02-M2	24.3 x 12.3		38°	V
	LL01ZZ-EXxxL06	21 x 9.3	40° 30x65°		
LL01ZZ-FLxxL06	22.2 x 10.6	10° 40° 30x65°			
LL01CR-FoxxL06	35.8 x 15.75	40°			
LL01LU-AAxxL06	19.7 x 13.8	20x65°			
LL01LU-LHxxL06	21 x 9.15	15°			
LL01NI-DZxxL06	22 x 15.7	20x40°			
LL01OS-CBxxL06	25.6 x 10	15°			
LL01ZZ-AHAxxL06	50 x 25.4		5°		





XML
EZW



MKR



MTG



MTG2



■ XML EZW

Type	Part Number	DxH(mm)	Full Angle	FWHM	Holder	
Single	LL01CR-ABGxxL02	34 x 15.7		24°		
	LL01CR-ACZxxL02	27.8 x 10.2		24° 38°		
	LL01ED-ABYxxL02	44 x 14.1		24°		
	LL01CR-AQHxxL02	44 x 14.1		38° 45°		
	LL01CR-BRxxL06	19.65 x 12.5	40°			
	LL01CR-ADGxxL06-M2	32.8 x 18	20° 30° 40° 60°		V	
	LL01CR-SQxxL06	19.4 x 12.9	60°			
	LL01CR-WlxxL02	28.8 x 17.4		25° 40°		
	LL01ED-ACZxxL02	35 x 10.7		24° 38°		
	LL01ED-AJxxL06	28.9 x 19.7	25° 40° 60°			
	LL01ED-AKxxL06	34.4 x 18.8	25° 40°			
	LL01ED-AQxxL06	22.5 x 10.5	60°			
	LL01ED-ASxxL06	19.9 x 10.15	60°			
	LL01ED-BBxxL06	35.8 x 16.5	60°			
	LL01ED-CVxxL06	19.6 x 12.3	45°			
	LL01ED-CYxxL06	26.8 x 18.9	30° 45°			
	LL01NI-GRxxL06	19.45 x 13.5	40° 60° 80°			
	LL01OS-AXxxL02	20 x 11.5	40° 60°			
	LL01OS-BWxxL06	37.2 x 15.35	30°			
	LL01OS-BYxxL06	37.2 x 15.35	30°			
6 in 1	LL01ZZ-AFLxxL02	22.2 x 10.4		35° 50°		
	LL01ZZ-AHZxxL02-M2	24.3 x 12.3		24° 38°	V	
	LL01ZZ-FLxxL06	22.2 x 10.6	40°			
	LL01OS-CBxxL06	25.6 x 10	15°			
	LL06ED-ADxxL06	73.3 x 11.5	25° 40° 60°			
	LL06CR-AXMxxL06-M2	76 x 13		15° 25°	V	
	9 in 1	LL09ED-ATxxL06	90.6 x 17.5	40°		
		12 in 1	LL12ED-AGxxL06	112 x 13.4	45°	
	Street Lighting		LL01CR-XW70140L02	32 x 17.6 x 9.8		70°x140° (Asymmetry)
		LL01LU-AGV80150L02	32 x 18.5 x 9.5		80°x150° (Asymmetry)	

■ MKR

Type	Part Number	DxH(mm)	Full Angle	FWHM	Holder	
Single	LL01CR-ABGxxL02	34 x 15.7		22°		
	LL01CR-ABHxxL02	50 x 10.4		40° 60°		
	LL01CR-ADPxxL06	75.8 x 35.2		15° 24° 38°		
	LL01ED-ABYxxL02	44 x 14.1		24°		
	LL01CR-AQHxxL02	44 x 14.1		38°		
	LL01CR-BRxxL06	19.65 x 12.5	40°			
	LL01CR-DGxxL06	28.8 x 16.75	20° 30° 40° 50° 60°			
	LL01CR-PVxxL02	45 x 23.7	45° 60° 80°			
	LL01CR-WlxxL02	28.8 x 17.4		25° 40°		
	LL01CR-ZExxL02	35 x 20.4		20° 30° 45°		
	LL01ED-AFDxxL06	26 x 15.3		20°		
	LL01ED-AKxxL06	34.4 x 18.8	25° 40°			
	LL01ED-CYxxL06	26.8 x 18.9	30°			
	6 in 1	LL01LU-AFLxxL02-M2	24.3 x 11.5		35° 50° 70°	V
		LL06ED-ADxxL06	73.3 x 11.5		60°	
		LL06CR-AXMxxL06-M2	76 x 13		25° 35°	V
	Street Lighting	LL06CR-AXLxxL06-M2	76 x 13		25°	V
		LL01LU-AGV80150L02	32 x 18.5 x 9.5		80°x150° (Asymmetry)	

■ MTG/MTG2

Type	Part Number	DxH(mm)	Full Angle	FWHM	Holder	
Single	LL01CR-ABGxxL02	34 x 15.7		24° 38° 55°		
	LL01CR-ABHxxL02	50 x 10.4		40° 60°		
	LL01CR-ADPxxL06	75.8 x 35.2		15° 24° 38°		
	LL01ED-ABYxxL02	44 x 14.1		24°		
	LL01CR-PVxxL02-M2	47.2 x 25.65	45° 60° 80°		V	
	LL01CR-ZExxL02-M2	37.1 x 20.7		20° 30° 45°	V	
	LL01ED-ABXxxL06	75.8 x 24.35		24° 38°		
	LL01ED-AFDxxL06	26 x 15.3		20°		
	LL01ED-AYxxL06-M2	46 x 27.1	38°		10°	V
	LL01CR-AFLxxL02-M2	24.3 x 11.5		35° 50° 70°	V	
LL01CR-AQHxxL06	44 x 14.1		38°			

■ CXA1304

Type	Part Number	DxH(mm)	Full Angle	FWHM	Holder
Single	LL01CR-ABHxxL02	50 x 10.4		40° 60°	
	LL01ED-ABYxxL02	44 x 14.1		24°	
	LL01CR-AQHxxL02	44 x 14.1		38° 45°	
	LL01CR-DGxxL06	28.8 x 16.75	20° 30° 40° 50° 60°		
	LL01CR-PVxxL02	45 x 23.7	45° 60° 80°		
	LL01ED-AFDxxL06	26 x 15.5		15° 20°	
	LL01ED-AKxxL06	34.4 x 18.8	25° 40°		
	LL01ED-AYxxL06	43.8 x 24.5	10° 38°		
	LL01ZZ-AFLxxL02	22.2 x 10.4		35° 50°	
Reflector	LL01BR-TYRxxR34-P	45 x 19.4		24° 34° 50°	
	LL01CT-AJZxxR49	50 x 19		38° 55°	
	LL01CT-AMXxxR49	44x11.8		45°	
	LL01ED-AJMxxR49	35.2 x 7.8		24° 38°	
	LL01ED-ALlxxR49	50 x 19		24° 55°	

■ CXA15xx

Type	Part Number	DxH(mm)	Full Angle	FWHM	Holder	
Single	LL01CR-ABGxxL02	34x15.7		55°		
	LL01CR-ABHxxL06	50x10.4		40° 60°		
	LL01CR-PVxxL02	45x23.7	45° 60° 80°			
	LL01CR-AQHxxL02	44x14.1		38° 45°		
	LL01ED-ABYxxL02	44x14.1		24°		
	LL01ED-ABXxxL06	75.8x24.35		38°		
	LL01ED-ASAxxL06-P	90.6x22		38°		
	LL01CR-BAYxxL06	75.8x22.5		24° 38°		
	LL01ED-AYxxL06	43.8x24.5	38°	10°		
	LL01CT-AMYxxL06	75.8x23		38°		
	LL01ZZ-AOFxxL06-M2	76.4x16.7		24° 38°	V	
	LL01CT-APGxxL06-M2	90.8x22		24° 38°	V	
	LL01CR-BGS24L06	34 x 15.7		24°		
	Reflector	LL01BR-TYRxxR34-P	45x19.4		24° 34° 50°	
		LL01CIOTxxR2-P	50x30		20° 33° 45°	
LL01CR-AYGxxR49		75x45		15° 24° 38°		
LL01CT-AJZxxR49		50x19		38° 55°		
LL01CT-ALNxxR49		75.8x20.1		38° 45°		
LL01CT-ALOxxR49		90.5x23.2		24° 38° 45°		
LL01CT-AMXxxR49		44x11.8		45°		
LL01ED-AJMxxR49		35.2x7.8		24° 38°	V	
LL01ED-AKVxxR49		50.5x29.5		36°		
LL01ED-AKYxxR49		50x30		24° 38° 45°		
LL01ED-ALAxR49		75x20.1		24° 38°		
LL01ED-ALlxxR49		50x19		24° 38° 55°		
LL01SP-ATHxxR49		75x40		15° 24° 38°		
LL01ZZ-AAAxL49		70x35		24° 38° 55°		



CXA
1304



CXA
15xx





**CXA
1816**



**CXA
25xx**



**CXA
3050**



■ **CXA1816**

Type	Part Number	DxH(mm)	Full Angle	FWHM	Holder
Single	LL01CT-AMYxxL06	75.8 x 23		24° 38°	
	LL01ZZ-AOFxxL06-M2	76.4 x 16.7		24° 38°	V
	LL01CT-APGxxL06-M2	90.8 x 22		24° 38°	V
	LL01ED-ABXxxL06	75.8 x 24.35		24° 38°	
	LL01ED-ASAxxL06-P	90.6 x 22		12° 24° 38°	
Reflector	LL01BR-TYRxxR34-P	45 x 19.4		24° 34° 50°	
	LL01CT-ALOxxR49	90.5x23.2		24° 38° 45°	
	LL01ED-AKAxxR49	85 x 23.5		60°	
	LL01ED-ALIxxR49	50 x 19		24° 55°	
	LL01ED-ALJxxR49	91.5 x 23.2		24° 38° 45°	
	LL01SP-ASOxxR49	90 x 50		15° 24° 38° 55°	
	LL01SP-ATHxxR49	75x40		15° 24° 38°	
	LL01CR-BGCxxR49-BKG15L02	75 x 45		15° 24° 38°	
	LL01CR-BDJ80R49	90 x 40		80°	
LL01CR-BIYxxR49-BIZ120L0	100 x 57		13° 24°		

■ **CXA25xx**

Type	Part Number	DxH(mm)	Full Angle	FWHM	Holder
Single	LL01CT-AMYxxL06	75.8 x 23		24° 38°	
	LL01ZZ-AOFxxL06-M2	76.4 x 16.7		24° 38°	V
	LL01CT-APGxxL06-M2	90.8 x 22		24° 38°	V
	LL01ED-ABXxxL06	75.8 x 24.35		24° 38°	
	LL01ED-ASAxxL06-P	90.6 x 22	45° 60° 80°	12° 24° 38°	
Reflector	LL01CIOTxxR2-P	50x30		20° 33° 45°	
	LL01CR-AYMxxR35-P	90 x 50		15° 24° 38°	
	LL01ED-AKAxxR49	85 x 23.5		60°	V
	LL01ED-AKXxxR49	116 x 32		24° 38°	V
	LL01ED-ALJxxR49	91.5 x 23.2		24° 38° 45°	V
	LL01SP-ASOxxR49	90 x 50		15° 24° 38° 55°	

■ **CXA3050**

Type	Part Number	DxH(mm)	Full Angle	FWHM	Holder
Single	LL01CT-AMYxxL06	75.8 x 23		24° 38°	
	LL01CT-APGxxL06	84.6 x 18		24° 38°	
Reflector	LL01ED-AKAxxR49	85 x 23.5		60°	
	LL01ED-AKXxxR49	116 x 32		24° 38°	
	LL01ED-ALJxxR49	91.5 x 23.2		24° 38° 45°	



■ LHCI 1203

Type	Part Number	DxH(mm)	Full Angle	FWHM	Holder
Single	LL01ZZ-AOFxxL06-M2	76.4 x 16.7		24° 38°	V
	LL01CT-APGxxL06-M2	90.8 x 22		24° 38°	V
	LL01ED-ABXxxL06	75.8 x 24.35		38°	
Reflector	LL01SP-ASOxxR49	90 x 50		15° 24° 38° 55°	
	LL01SP-ATHxxR49	75 x 40		15° 24° 38°	
	LL01ZZ-AAAxL49	70 x 35		38° 55°	

■ LHCI 1205

Type	Part Number	DxH(mm)	Full Angle	FWHM	Holder
Single	LL01CR-BAYxxL06	75.8 x 22.5		24° 38°	
	LL01CT-AMYxxL06	75.8 x 23		24° 38°	
	LL01ZZ-AOFxxL06-M2	76.4 x 16.7		24° 38°	V
	LL01CT-APGxxL06-M2	90.8 x 22		24° 38°	V
	LL01ED-ABXxxL06	75.8 x 24.35		24° 38°	
	LL01ED-ASAxL06-P	90.6 x 22		12° 24° 38°	
Reflector	LL01SP-ASOxxR49	90 x 50		15° 24° 38° 55°	
	LL01SP-ATHxxR49	75 x 40		15° 24° 38°	
	LL01TJ-AONxxR49	50 x 20		24° 60°	
	LL01ZZ-AAAxL49	70 x 35		38° 55°	

■ LHCI 1204

Type	Part Number	DxH(mm)	Full Angle	FWHM	Holder
Single	LL01CR-BAYxxL06	75.8 x 22.5		24° 38°	
	LL01CT-AMYxxL06	75.8 x 23		24° 38°	
	LL01ZZ-AOFxxL06-M2	76.4 x 16.7		24° 38°	V
	LL01CT-APGxxL06-M2	90.8 x 22		24° 38°	V
	LL01ED-ABXxxL06	75.8 x 24.35		24° 38°	
	LL01ED-ASAxL06-P	90.6 x 22		12° 24° 38°	
Reflector	LL01SP-ASOxxR49	90 x 50		15° 24° 38° 55°	
	LL01SP-ATHxxR49	75 x 40		15° 24° 38°	
	LL01ZZ-AAAxL49	70 x 35		38° 55°	

■ LHCI 1208

Type	Part Number	DxH(mm)	Full Angle	FWHM	Holder
Single	LL01CR-BAYxxL06	75.8 x 22.5		24° 38°	
	LL01CT-AMYxxL06	75.8 x 23		24°	
	LL01ZZ-AOFxxL06-M2	76.4 x 16.7		24° 38°	V
	LL01CT-APGxxL06-M2	90.8 x 22		24° 38°	V
	LL01ED-ABXxxL06	75.8 x 24.35		24° 38°	
	LL01ED-ASAxL06-P	90.6 x 22		12° 24° 38°	
Reflector	LL01SP-ASOxxR49	90 x 50		15° 24° 38° 55°	
	LL01SP-ATHxxR49	75 x 40		15° 24° 38°	
	LL01TJ-AONxxR49	50 x 20		24° 60°	
	LL01ZZ-AAAxL49	70 x 35		38° 55°	



■ Rebel

Type	Part Number	DxH(mm)	Full Angle	FWHM	Holder
Single	LL01CR-BRxxL06	19.65 x 12.5	10x45° 15x50° 15x80° 40x90° 40°		
	LL01LU-DFxxL06-M2	13.5 x 7.35	80° 100° 30x65°		V
	LL01CR-DGxxL06	28.8 x 16.75	30° 40° 50° 60°		
	LL01CR-HQxxL06	14.8 x 9.5	40° 60° 80°		
	LL01CR-NExxL06	19.4 x 15	25° 40° 60° 80° 10x45° 25x45°		
	LL01ED-AJxxL06	28.9 x 19.7	45° 60°		
	LL01ED-AKxxL06	34.4 x 18.8	40°		
	LL01ED-CTxxL06	31 x 11.2	38° 80°		
	LL01OS-AFC15L06	19.4 x 11.43		10° 15° 25° 30°	
	LL01LU-AFCxxL06-M2	21.3 x 12.4		10° 15° 25° 30° 10x35° 15x30°	V
	LL01NI-AAFxxL02	11.8 x 6.5		45° 60°	
	LL01NI-GRxxL06	19.45 x 13.5	40° 60° 80°		
	LL01OS-AXxxL02	20 x 11.5	20° 40° 60°		
	LL01OS-BWxxL06	37.2 x 15.35	30°		
	LL01OS-BYxxL06	37.2 x 15.35	30°		
	3 in 1	LL01OS-MQxxL06	19.45 x 13.7	40° 60°	
LL01LU-QDxxL06-M2		23 x 9.63	25° 40° 60° 30x65°		V
LL01LU-FLxxL06-M2		24.3 x 11.5	10° 25° 40° 60° 30x65°		V
LL01ED-FMxxL06		19.9 x 10.55	38°		
LL01LU-AAxxL06		19.7 x 13.8	20x65°		
LL01LU-LHxxL06-M2		22.4 x 9.63	15°		V
LL01ZZ-AHAXxxL06		50 x 25.4		5°	
LL03CR-AZxxL06		50 x 14.5	25° 45°		
LL03CR-RXxxL06		35 x 9.6	40° 60°		
LL03ED-UYxxL06		33.2 x 10.3	40°		
4 in 1	LL03LU-DMxxL06	23.1 x 11	15° 25° 40°		
	LL03LU-DOxxL06	35 x 10.6	15° 25° 40°		
	LL03OS-GKxxL06	33.2 x 9.8	25° 40° 60°		
	LL04CR-RXxxL06	35 x 9.7	40° 60°		
	LL04ED-UYxxL06	37 x 10.3	40°		
	LL04LU-DNxxL06	25.4 x 10.5	15° 25° 40°		
Street Lighting	LL04LU-DOxxL06	35 x 10.4	15° 25° 40°		
	LL04LU-GPxxL06	22.2 x 6.8	15° 25° 45°		
	LL04OS-GKxxL06	37 x 9.8	40° 60°		
	LL04ZZ-EXxxL06	25.4 x 10.4	30°		

Type	Part Number	DxH(mm)	Full Angle	FWHM	Holder
6 in 1	LL06CR-CKxL06	73.2 x 13.5	25°		
	LL06CR-RXxxL06	50 x 9.65	40° 60°		
	LL06ED-ADxxL06	73.3 x 11.5	25° 40° 60°		
	LL06CR-AXMxxL06-M2	76 x 13		15° 25°	V
	LL06CR-AXLxxL06-M2	76 x 13		25°	V
	7 in 1	LL07CR-RXxxL06	50 x 10.3	40° 60°	
LL07ED-UYxxL06		47 x 10.3	40°		
LL07OS-GKxxL06		47 x 9.8	40° 60°		
LL07ZZ-FUxxL06		50.35 x 10.7		15° 25°	
LL07ZZ-FVxxL06		39.2 x 10.6		15° 25°	
9 in 1	LL09CR-RXxxL06	70 x 10.3	40° 60°		
	LL09ED-UYxxL06	67 x 10.3	40°		
	LL09OS-GKxxL06	67 x 9.8	40° 60°		
	LL09ED-ATxxL06	90.6 x 17.5	40°		
12 in 1	LL12CR-RXxxL06	70 x 10.3	40° 60°		
	LL12ED-AGxxL06	112 x 13.4	45°		
	LL12ED-UYxxL06	67 x 10.3	40°		
15 in 1	LL12OS-GKxxL06	67 x 9.8	40° 60°		
18 in 1	LL15ED-BHxxL06	95 x 11.1	40°		
24 in 1	LL18ED-BIxxL06	110 x 13.1	25° 40°		
36 in 1	LL24ED-ABxxL06	174.5 x 12.7	45°		
Street Lighting	LL36ED-AAxxL06	140 x 12.6	45°		
	LL01CR-APM80150L02	18 x 12.5 x 6.95		80°x150° (Asymmetry)	
	LL01CR-AU85135L02	18 x 10.2 x 6.1		85°x135° (Asymmetry)	
	LL01CR-FT60135L02	18 x 9.3 x 5.9		60°x135° (Symmetry)	
	LL01CR-KM6090L02	17.55 x 11.6 x 8.6		60°x90° (Symmetry)	
	LL01CR-OG85150L02	18 x 8.95 x 6.2		85°x150° (Symmetry)	
	LL01CR-OW70130L02	17.4 x 12.75 x 7.2		70°x130° (Asymmetry)	
	LL01LU-AIK45135L02	18 x 12.5 x 7.05		45°x135° (Asymmetry)	
	LL01LU-UQ70140L02	18 x 11 x 6.6		70°x140° (Asymmetry)	
	LL01ZZ-AGX45155L02	18 x 12.5 x 7		45°x155° (Asymmetry)	
LL24CR-AU75135L02	120 x 100 x 10.2		75°x135° (Asymmetry)		

Rebel Es

Type	Part Number	DxH(mm)	Full Angle	FWHM	Holder
Single	LL01CR-BRxxL06	19.65 x 12.5	40° 10x45° 15x50° 15x80° 40x90°		
	LL01LU-DFxxL06-M2	13.5 x 7.35	80° 100° 30x65°		V
	LL01CR-DGxxL06	28.8 x 16.75	30° 40° 50° 60°		
	LL01CR-HQxxL06	14.8 x 9.5	40° 60° 80°		
	LL01CR-NExxL06	19.4 x 15	25° 40° 60° 80° 10x45° 25x45°		
	LL01ED-AJxxL06	28.9 x 18.55	60°		
	LL01LU-AFCxxL06-M2	21.3 x 12.4	15x60° 20x50°		V
	LL01NI-AAFxxL02	11.8 x 6.5		60°	
	LL01NI-GRxxL06	19.45 x 13.5	40° 60° 80°		
	LL01OS-AXxxL02	20 x 11.4	60°		
	LL01OS-MQxxL06	19.45 x 13.7	40° 60°		
	LL01LU-EXxxL06-M2	22.4 x 9.7	25° 40° 60° 30x65°		V
	LL01LU-FLxxL06-M2	24.3 x 11.5	10° 25° 40° 60° 30x65°		V
LL01LU-LHxxL06-M2	22.4 x 9.63	15°		V	
LL01ZZ-AHAxxL06	50 x 25.4			5°	
3 in 1	LL03CR-AZxxL06	50 x 14.5	45° 60°		
	LL03CR-RXxxL06	35 x 9.6	40° 60°		
	LL03ED-UYxxL06	33.2 x 10.3	40°		
4 in 1	LL04CR-RXxxL06	35 x 9.7	40° 60°		
	LL04ED-UYxxL06	37 x 10.3	40°		
	LL04LU-GPxxL06	22.2 x 6.8	15° 25° 45°		
	LL04DD-AMGxxL06	35 x 7		38°	
6 in 1	LL06CR-RXxxL06	50 x 9.65	40° 60°		
	LL06ED-ADxxL06	73.3 x 11.5	8° 25° 40° 60°		
7 in 1	LL07CR-RXxxL06	50 x 10.3	40° 60°		
	LL07ED-BFxxL06	43.9 x 8.55	25°		
	LL07ED-GKxxL06	47 x 10.2	25° 40°		
	LL07ED-UYxxL06	47 x 10.3	40°		

Type	Part Number	DxH(mm)	Full Angle	FWHM	Holder
9 in 1	LL09CR-RXxxL06	70 x 10.3	40° 60°		
	LL09ED-BZxxL06	90.75 x 16.5	15° 25°		
	LL09ED-UYxxL06	67 x 10.3	40°		
12 in 1	LL12CR-RXxxL06	70 x 10.3	40° 60°		
	LL12ED-UYxxL06	67 x 10.3	40°		
15 in 1	LL15ED-BHxxL06	95 x 11.1	40°		
18 in 1	LL18ED-BLxxL06	110 x 13.1	40°		
24 in 1	LL24ED-ABxxL06	174.5 x 12.7	25° 45°		
36 in 1	LL36ED-AAxxL06	140 x 12.6	45°		
12 in 1	LL01CR-AU85135L02	18 x 10.2 x 6.1		85°x135° (Asymmetry)	
	LL01CR-FT60135L02	18 x 9.3 x 5.9		60°x135° (Symmetry)	
	LL01CR-KM6090L02	17.55 x 11.6 x 8.6		60°x90° (Symmetry)	
	LL01CR-OG85150L02	18 x 8.95 x 6.2		85°x150° (Symmetry)	
	LL01LU-AEV50150L02	18 x 12.5 x 6.3		50°x150° (Asymmetry)	
	LL01LU-AIK45135L02	18 x 12.5 x 7.05		45°x135° (Asymmetry)	
	LL01LU-UQ70140L02	18 x 11 x 6.6		70°x140° (Asymmetry)	
	LL01ZZ-AGX45155L02	18 x 12.5 x 7		45°x155° (Asymmetry)	
	LL14LU-ALY90130L19	250 x 60 x 9.3		90°x130° (Asymmetry)	
	LL24CR-AU75135L02	120 x 100 x 10.2		75°x135° (Asymmetry)	
	LL28CR-UI65140L14	259.2 x 79.7 x 12.2		65°x140° (Asymmetry)	





■ Luxeon T

Type	Part Number	DxH(mm)	Full Angle	FWHM	Holder
Single	LL01CR-BExxL06	20.9 x 9.2	60°		
	LL01CR-BMxxL06	35.8 x 15.85	40°		
	LL01CR-BNExxL06	19.4 x 14.6	40° 35°x70°		
	LL01CR-BRxxL06	19.65 x 12.5	10x45° 15x50° 15x80° 40x90°		
	LL01CR-DFxxL06	11.8 x 6.65	80° 100° 30°x65°		
	LL01CR-DGxxL06	28.8 x 16.75	20° 30° 40° 50° 60°		
	LL01CR-HQxxL06	14.8 x 9.4	60°		
	LL01CR-NExxL06	19.4 x 15	15° 17° 25° 40° 60° 80° 10x45° 25x45°		
	LL01CR-PVxxL02	45 x 23.7	45° 60° 80°		
	LL01CR-SQxxL06	19.4 x 12.9	40° 60° 80°		
	LL01CR-WlxxL02	28.8 x 17.4		25° 40°	
	LL01CR-XSxxL06	22.2 x 10.6	40°		
	LL01CR-YJxxL02	19.4 x 12.7	40° 60° 80° 100°		
	LL01CR-ZExxL02	35 x 20.4		20°	
	LL01ED-AFDxxL06	26 x 15.3		20°	
	LL01ED-AJxxL06	28.9 x 19.7	25° 40° 60°		
	LL01ED-AKxxL06	34.4 x 18.8	40°		
	LL01ED-ALxxL06	19.7 x 9.9	30x65°		
	LL01ED-ANxxL06	22.7 x 9.6	15x50°		
	LL01ED-AOxxL06	19.4 x 13.45	60°		
	LL01ED-ASxxR06	19.9 x 10.55	38°		
	LL01ED-CTxxL06	31 x 11.2	80°		
	LL01ED-CYxxL06	26.8 x 18.9	30°		
	LL01LU-AFCxxL06	19.4 x 11.8	20x50°		
	LL01CR-AAFxxL02	11.8 x 6.65		25°	
	LL01NI-AAFxxL02	11.8 x 6.65		45° 60°	
	LL01NI-ANExxL02	19.4 x 14.94		10° 20° 30°	
	LL01NI-GRxxL06	19.45 x 13.5	40° 60° 80°		
	LL01OS-AXxxL02	20 x 11.5	20° 40° 60°		
	LL01OS-BWxxL06	37.2 x 15.35	30°		
LL01OS-BYxxL06	37.2 x 15.35	10° 30°			
LL01OS-MQxxL06	19.45 x 13.7	15° 25° 40° 60°			
LL01ZZ-AFLxxL02	22.2 x 10.4		35°		
LL01ZZ-AHZxxL02	22.2 x 10.6		24° 38°		
LL01ZZ-EXxxL06	21 x 9.3	40° 30°x65°			

Type	Part Number	DxH(mm)	Full Angle	FWHM	Holder
Single	LL01ZZ-FLxxL06	22.2 x 10.6	10° 25° 40° 60°		
	LL01CR-ADT40L06	35 x 10.65	40°		
	LL01CR-FO40L06	35.8 x 15.75	40°		
	LL01ED-FM38L06	19.9 x 10.55	38°		
	LL01LU-AA2065L06	19.7 x 13.8	20°x65°		
	LL01LU-LH15L06	21 x 9.15	15°		
	LL01NI-DZ2040L06	22 x 15.7	20°x40°		
	LL01OS-CB15L06	25.6 x 10	15°		
	LL03CR-AZ25L06	50x14.5	25° 45°		
	LL03CR-RX25L06	35x9.6	25° 40° 60°		
3 in 1	LL03ED-BC15L06	43.9x9.5		15° 25°	
	LL03ED-CT38L06	31x11.2	38° 80°		
	LL03ED-UY40L06	33.2x10.3	40° 60°		
	LL03LU-DM15L06	23.1x11	15° 25°		
	LL03LU-DO15L06	35x10.6	15° 25°		
	LL03OS-GK40L06	33.2x9.8	40° 60° 80°		
	LL04CR-RX40L06	35x9.7	40° 60°		
4 in 1	LL04ED-BD15L06	43.9x9.5		15°	
	LL04LU-DN15L06	25.4x10.5		15° 25°	
	LL04LU-DO15L06	35x10.4		15° 25°	
	LL04LU-GP15L06	22.2x6.8		15°	
LL04OS-GK40L06	37x9.8	40° 60° 80°			
6 in 1	LL06CR-RX40L06	50x9.65	40° 60°		
7 in 1	LL07CR-RX40L06	50x10.3	40° 60°		
	LL07OS-GK40L06	47x9.8	40° 60° 80°		
9 in 1	LL09CR-RX40L06	70x10.3	40° 60°		
	LL09OS-GK40L06	67x9.8	40° 60° 80°		
12 in 1	LL12CR-RX40L06	70x10.3	40° 60°		
	LL12OS-GK40L06	67x9.8	40° 60° 80°		
Street Lighting	LL01CR-FT60135L02	18 x 9.3 x 5.9		60°x135° (Symmetry)	
	LL01CR-OW70130L02	17.4 x 12.75 x 7.2		70°x130° (Asymmetry)	
	LL01OS-AU60130L02	30.1 x 14.3 x 8.5		60°x130° (Symmetry)	
	LL01OS-AU60140L02	16 x 8.8 x 5.33		60°x140° (Asymmetry)	

Luxeon M

Type	Part Number	DxH(mm)	Full Angle	FWHM	Holder
Single	LL01CR-ABGxxL02	34 x 15.7		24° 38° 55°	
	LL01CR-ABHxxL02	50 x 10.4		40° 60°	
	LL01CR-ADPxxL06	75.8 x 35.2		15° 24° 38°	
	LL01ED-ABYxxL02	44 x 14.1		24°	
	LL01CR-BRxxL06	19.65 x 12.5	40°		
	LL01LU-DGxxL06-M2	32.8 x 18		30° 40° 50° 60°	V
	LL01CR-PVxxL02	45 x 23.7	45° 60° 80°		
	LL01CR-WlxxL02	28.8 x 17.4		25° 40°	
	LL01CR-ZExxL02	35 x 20.4		20° 30° 45°	
	LL01ED-AFDxxL06	26 x 15.3		20°	
	LL01ED-AJxxL06	28.9 x 18.55	60°		
	LL01ED-AKxxL06	34.4 x 18.8	40°		
	LL01ED-AYxxL06	43.8 x 24.5	38°	10°	
	LL01ED-CYxxL06	26.8 x 18.9	30° 45°		
	LL01LU-AFLxxL02-M2	24.3 x 11.5		35° 50° 70°	V
LL01ED-BVxxL06	19.9 x 10.7	60°			
6 in 1	LL06ED-ADxxL06	73.3 x 11.5	40° 60°		
	LL06CR-AXMxxL06-M2	76 x 13		15° 25° 35°	V
	LL06CR-AXLxxL06-M2	76 x 13		25°	V
Street Lighting	LL01CR-XW70140L02	32 x 17.6 x 9.8		70°x140° (Asymmetry)	
	LL01LU-AGV80150L02	32 x 18.5 x 9.5		80°x150° (Asymmetry)	

Luxeon S

Type	Part Number	DxH(mm)	Full Angle	FWHM	Holder
Single	LL01CR-ABGxxL02	34 x 15.7		24° 38° 55°	
	LL01CR-ADPxxL06	75.8 x 35.2		15° 24° 38°	
	LL01ED-ABYxxL02	44 x 14.1		24°	
	LL01CR-PVxxL02	45 x 23.7	45° 60° 80°		
	LL01CR-ZExxL02	35 x 20.4		20° 30° 45°	
	LL01ED-AYxxL06	43.8 x 24.5	38°	10°	
	LL01LU-AFLxxL02-M2	24.3 x 11.5		35° 50°	V



■ Oslon 80°

Type	Part Number	DxH(mm)	Full Angle	FWHM	Holder
Single	LL01OS-BDFxxL06-M2	13.5 x 7.35	40° 60° 100°		V
	LL01CR-BRxxL06	19.65 x 12.5	40°		
	LL01CR-DGxxL06	28.8 x 16.65	30° 40° 60°		
	LL01CR-HQxxL06	14.8 x 9.6	15° 30° 40° 60° 80°		
	LL01CR-NExxL06	19.4 x 15	40° 60° 80° 25x45°		
	LL01CR-OTxxL06	15 x 9.7	40° 60° 80°		
	LL01ED-AJxxL06	28.9 x 19.7	40° 60°		
	LL01ED-AKxxL06	34.4 x 18.8	40°		
	LL01ED-BBxxL06	35.8 x 16.5	60°		
	LL01ED-CTxxL06	31 x 11.2	38°		
	LL01OS-AFCxxL06-M2	21.3 x 12.4		10° 15° 25° 30° 10x35° 15x30°	V
	LL01OS-AAFxxL06-M2	13.5 x 7.35		25°	V
	LL01NI-GRxxL06	19.45 x 13.5	40° 60° 80°		
	LL01OS-AXxxL02	20 x 11.5	40° 60°		
	LL01OS-BWxxL06	37.2 x 15.35	30°		
	LL01OS-BYxxL06	37.2 x 15.35	30°		
	LL01OS-HGxxL06	10 x 6	40° 60°		
	LL01OS-MQxxL06-M2	21.05 x 14.75	15° 25° 40° 60°		V
	LL01OS-EXxxL06-M2	22.4 x 9.7	10° 25° 40° 60° 30x65°		V
	3 in 1	LL01ZZ-FLxxL06	22.2 x 10.6	25° 40° 60°	
LL01ED-FMxxL06		19.9 x 10.55	38°		
LL01OS-CBxxL06		25.6 x 10	15°		
LL01ZZ-AHAxxL06		50 x 25.4		5°	
LL01OS-BFVxxL06		20.8 x 12.35		15° 25° 30° 15x40°	
LL03CR-RXxxL06		35 x 9.6	40° 60°		
LL03ED-UYxxL06		33.2 x 10.3	40°		
LL03LU-DMxxL06		23.1 x 11	15° 25° 40°		
LL03LU-DOxxL06		35 x 10.6	15° 25° 40°		
LL03OS-GKxxL06		33.2 x 9.8	25° 40° 60° 80°		
4 in 1	LL04CR-GPxxL06	22.2 x 6.7	25° 38° 45°		
	LL04CR-RXxxL06	35 x 9.7	40° 60°		
	LL04ED-UYxxL06	37 x 10.3	40°		
	LL04LU-DNxxL06	25.4 x 10.5		15° 25° 40°	
	LL04LU-DOxxL06	35 x 10.4		15° 25° 40°	
LL04OS-GKxxL06	37 x 9.8	40° 60° 80°			

Type	Part Number	DxH(mm)	Full Angle	FWHM	Holder
6 in 1	LL06CR-AXNxxL06-M2	76 x 13		25°	V
	LL06CR-RXxxL06	50 x 9.65	40° 60°		
	LL06ED-ADxxL06	73.3 x 11.5	25° 40° 60°		
	LL06CR-AXMxxL06-M2	76 x 13		15° 25° 35°	V
	LL06CR-AXLxxL06-M2	76 x 13		25°	V
7 in 1	LL07CR-RXxxL06	50 x 10.3	40° 60°		
	LL07ED-UYxxL06	47 x 10.3	40°		
	LL07OS-GKxxL06	47 x 9.8	40° 60° 80°		
	LL07ZZ-FUxxL06	50.35 x 10.7	15° 25°		
	LL07ZZ-FVxxL06	39.2 x 10.6	15° 25°		
9 in 1	LL09CR-RXxxL06	70 x 10.3	40° 60°		
	LL09ED-UYxxL06	67 x 10.3	40°		
	LL09OS-GKxxL06	67 x 9.8	40° 60° 80°		
12 in 1	LL12CR-RXxxL06	70 x 10.3	40° 60°		
	LL12ED-AGxxL06	112 x 13.4	45°		
	LL12ED-UYxxL06	67 x 10.3	40°		
	LL12OS-GKxxL06	67 x 9.8	40° 60° 80°		
24 in 1	LL24ED-ABxxL06	174.5 x 12.7	45°		
36 in 1	LL36ED-AAxxL06	140 x 12.6	45°		
60 in 1	LL60ED-BOxxL06	180 x 13.1	45°		
Street Lighting	LL01CR-APM80150L02	18 x 12.5 x 6.95		80°x150° (Asymmetry)	
	LL01CR-AU85135L02	18 x 10.2 x 6.1		85°x135° (Asymmetry)	
	LL01CR-FT60135L02	18 x 9.3 x 5.9		60°x135° (Symmetry)	
	LL01CR-KM6090L02	17.55 x 11.6 x 8.6		60°x90° (Symmetry)	
	LL01CR-OW70130L02	17.4 x 12.75 x 7.2		70°x130° (Asymmetry)	
	LL01OS-AU60140L02	16 x 5.3		60°x140° (Asymmetry)	
	LL24CR-AU75135L02	120 x 100 x 10.2		75°x135° (Asymmetry)	
	LL28CR-UI65140L14	259.2 x 79.7 x 12.2		65°x140° (Asymmetry)	
	LL30CR-PT60140L02	235 x 71 x 9.4		60°x140° (Asymmetry)	



■ **Oslon 150°**

Type	Part Number	DxH(mm)	Full Angle	FWHM	Holder	Type	Part Number	DxH(mm)	Full Angle	FWHM	Holder
Single	LL01CR-BEXxL06	20.9 x 9.2		25° 40° 60°		9 in 1	LL09ED-UYxxL06	67 x 10.3	40°		
	LL01CR-BRxxL06	19.65 x 12.5	40° 15x50°			12 in 1	LL12ED-AGxxL06	112 x 13.4	40°		
	LL01OS-BDFxxL06-M2	13.5 x 7.35	25° 60° 80° 30x65°		V		LL12ED-BGxxL06	95 x 11.2	45°		
	LL01CR-DGxxL06	28.8 x 16.65	30° 40° 60°			18 in 1	LL12ED-UYxxL06	67 x 10.3	40°		
	LL01CR-HQxxL06	14.8 x 9.5	40° 60°				LL18ED-BlxxL06	110 x 13.1	40°		
	LL01CR-NExx06	19.4 x 15	25° 40° 60°			Street Lighting	LL01CR-AU85135L02	18 x 10.2 x 6.1		85°x135° (Asymmetry)	
	LL01CR-OTxxL06	15 x 9.7	40° 60° 80°				LL01CR-OW70130L02	17.4 x 12.75 x 7.2		70°x130° (Asymmetry)	
	LL01ED-AJxxL06	28.9 x 19.7	25° 40° 60°				LL24CR-AU75135L02	120 x 100 x 10.2		75°x135° (Asymmetry)	
	LL01ED-AKxxL06	34.4 x 18.8	25° 40°								
	LL01ED-ASxxR06	19.9 x 10.55	38° 60°								
	LL01ED-BBxxL06	35.8 x 16.5	60°								
	LL01ED-CTxxL06	31 x 11.2	38°								
	LL01ED-CVxxL06	19.6 x 12.3	25°								
	LL01NI-ANExxL02	19.4 x 14.94		10° 20° 30°							
	LL01NI-GRxxL06	19.45 x 13.5	40°								
	LL01OS-AXxxL02	20 x 11.5	40°								
	LL01OS-BWxxL06	37.2 x 15.35	30°								
	LL01OS-BYxxL06	37.2 x 15.35	30°								
	LL01OS-EXxxL06-M2	22.4 x 9.7	25° 40° 30x65°		V						
	LL01ZZ-FLxxL06	22.2 x 10.6	25° 40° 60° 30x65°								
LL01ED-FMxxL06	19.9 x 10.55	38°									
LL01OS-CBxxL06	25.6 x 10	15°									
LL01ZZ-AHAXxL06	50 x 25.4		5°								
3 in 1	LL03ED-CTxxL06	31 x 11.2									
	LL03ED-UYxxL06	33.2 x 10.3	38°								
	LL03LU-DMxxL06	23.1 x 11		40°							
4 in 1	LL03LU-DOxxL06	35 x 10.6		25° 40°							
	LL04ED-UYxxL06	37 x 10.3	25° 40°								
	LL04LU-DNxxL06	25.4 x 10.5	40°								
6 in 1	LL04LU-DOxxL06	35 x 10.4	25° 40°								
	LL06CR-AXNxxL06-M2	76 x 13		25°	V						
	LL06ED-ADxxL06	73.3 x 11.5	25°								
	LL06CR-AXMxxL06-M2	76 x 13		25°	V						
7 in 1	LL06CR-AXLxxL06-M2	76 x 13		25°	V						
	LL07ED-UYxxL06	47 x 10.3	40°								



Oslon
150°



■ Oslon Square

Type	Part Number	DxH(mm)	Full Angle	FWHM	Holder
Single	LL01CR-ACZxxL02	27.8 x 10.2		24° 38°	
	LL01OS-BDFxxL06-M2	13.5 x 7.35	40° 60°		V
	LL01CR-BEXxxL06	20.9 x 9.2	40° 60°		
	LL01CR-BMxxL06	35.8 x 15.85	40°		
	LL01CR-BNExxL06	19.4 x 14.6	25° 40° 60° 35x70°		
	LL01CR-BRxxL06	19.65 x 12.5	40° 10x45° 15x50° 15x80° 40x90°		
	LL01OS-BDFxL06-M2	11.8 x 6.65	40° 60° 80° 100° 30x65°		V
	LL01CR-DGxxL06	28.8 x 16.75	20° 30° 40° 50° 60°		
	LL01CR-HQxxL06	14.8 x 9.6	30° 40° 60° 80°		
	LL01CR-NExxL06	19.4 x 15	15° 25° 40° 60° 80° 10x45° 25x45°		
	LL01CR-OTxxL06	15 x 9.7	80°		
	LL01CR-SQxxL06	19.4 x 12.9	40° 60°		
	LL01CR-WLxxL02	28.8 x 17.4		25° 40°	
	LL01CR-XSxxL06	22.2 x 10.6	40°		
	LL01CR-YJxxL02	19.4 x 12.6	40° 60°		
	LL01CR-ZExxL02	35 x 20.4		20° 45°	
	LL01ED-ACZxxL02	35 x 10.7		24° 38°	
	LL01ED-AFDxxL06	26 x 15.3		20°	
	LL01ED-AJxxL06	28.9 x 19.7	40° 60°		
	LL01ED-AKxxL06	34.4 x 18.8	25° 40°		
	LL01ED-ALxxL06	19.65 x 11.4	15° 30x65°		
	LL01ED-ANxxL06	22.7 x 9.6	15x50°		
	LL01ED-AOxxL06	19.4 x 13.45	60°		
	LL01ED-ASxxR06	19.9 x 10.55	38°		
	LL01ED-ASxxL06	19.9 x 10.15	60°		
	LL01ED-CTxxL06	31 x 11.2	38°		
	LL01ED-CYxxL06	26.8 x 18.9	30° 45° 30x65°		
	LL01OS-AFCxxL06-M2	19.4 x 11.8	15x60° 20x50°		V
	LL01OS-AAFxxL06-M2	13.5 x 7.35		25° 45° 60°	V
	LL01NI-ANExxL02	19.4 x 14.94		10° 20° 30°	

Type	Part Number	DxH(mm)	Full Angle	FWHM	Holder	
	LL01NI-GRxxL06	19.45 x 13.5	40° 60° 80°			
	LL01OS-AXxxL02	20 x 11.5	20° 40° 60°			
	LL01OS-BWxxL06	37.2 x 15.35	30°			
	LL01OS-BYxxL06	37.2 x 15.35	30°			
	LL01OS-HGxxL06	10 x 6	40°			
	LL01OS-MQxxL06-M2	21.05 x 14.75	15° 25° 40° 60°		V	
	LL01OS-EXxxL06-M2	22.4 x 9.7	10° 25° 40° 60° 30x65°		V	
	LL01ZZ-FLxxL06	24.3 x 11.5	10° 40° 60°		V	
	LL01CR-ADTxxL06	35 x 10.65	40°			
	LL01CR-FOxxL06	35.8 x 15.75	40°			
	LL01ED-FMxxL06	19.9 x 10.55	38°			
	LL01OS-CBxxL06	25.6 x 10	15°			
	3 in 1	LL03CR-RXxxL06	35 x 9.6	40° 60°		
		LL03ED-CTxxL06	31 x 11.2	38°		
		LL03ED-UYxxL06	33.2 x 10.3	40°		
		LL03LU-DOxxL06	35 x 10.6		15° 25° 40°	
LL03OS-GKxxL06		33.2 x 9.8	25° 40° 60°			
LL03CR-CExxL06		34 x 9.9	38°			
4 in 1	LL03CR-HKxxL06	35 x 8.2	40°			
	LL04CR-RXxxL06	35 x 9.7	40° 60°			
	LL04ED-UYxxL06	37 x 10.3	40°			
	LL04LU-DOxxL06	35 x 10.4		15° 25° 40°		
6 in 1	LL04OS-GKxxL06	37 x 9.8	40° 60°			
	LL06CR-AXNxxL06-M2	76 x 13		25°	V	
	LL06CR-RXxxL06	50 x 9.65	40° 60°			
	LL06ED-ADxxL06	73.3 x 11.5	25° 40° 60°			
	LL06CR-AXMxxL06-M2	76 x 13		25°	V	
	LL06ED-BExxL06	43.9 x 8.6	25°			
7 in 1	LL06CR-AXLxxL06-M2	76 x 13		25°	V	
	LL07CR-RXxxL06	50 x 10.3	40° 60°			
	LL07ED-UYxxL06	47 x 10.3	40°			
	LL07OS-GKxxL06	47 x 9.8	40° 60°			
LL07ZZ-FUxxL06	50.35 x 10.7	15° 25°				



Oslon
150°



Oslon
Square



■ **Oslon Square**

Type	Part Number	DxH(mm)	Full Angle	FWHM	Holder
9 in 1	LL09CR-RXxxL06	70 x 10.3	40° 60°		
	LL09ED-BZxxL06	90.75 x 16.5	25°		
	LL09ED-UYxxL06	67 x 10.3	40°		
	LL09OS-GKxxL06	67 x 9.8	40° 60°		
12 in 1	LL12CR-RXxxL06	70 x 10.3	40° 60°		
	LL12ED-UYxxL06	67 x 10.3	40°		
	LL12OS-GKxxL06	67 x 9.8	40° 60°		
Street Lighting	LL01CR-APM80150L02	18 x 12.5 x 6.95		80°x150° (Asymmetry)	
	LL01CR-AU85135L02	18 x 10.2 x 6.1		85°x135° (Asymmetry)	
	LL01CR-FT60135L02	18 x 9.3 x 5.9		60°x135° (Symmetry)	
	LL01CR-KM6090L02	17.55 x 11.6 x 8.6		60°x90° (Symmetry)	
	LL01CR-OG85150L02	18 x 8.95 x 6.2		85°x150° (Symmetry)	
	LL01CR-OW70130L02	17.4 x 12.75 x 7.2		70°x130° (Asymmetry)	
	LL01LU-AEV50150L02	18 x 12.5 x 6.3		50°x150° (Asymmetry)	
	LL24CR-AU75135L02	120 x 100 x 10.2		75°x135° (Asymmetry)	
	LL28CR-UI65140L14	259.2 x 79.7 x 12.2		65°x140° (Asymmetry)	
	LL30CR-PT60140L02	235 x 71 x 9.4		60°x140° (Asymmetry)	

■ **W5AM**

Type	Part Number	DxH(mm)	Full Angle	FWHM	Holder
Single	LL01OS-AXxxL02-M2	21.5 x 13.35	20° 40° 60°		V
	LL01OS-BWxxL06	37.2 x 15.35	30°		
	LL01OS-BYxxL06	37.2 x 15.35	30°		
Street Lighting	LL01OS-AU60130L02	30.1 x 14.3 x 8.5		60°x130° (Symmetry)	
	LL01OS-EL85135L02	20.3 x 12.7 x 7.4		85°x135° (Asymmetry)	

■ **OSTAR**

Type	Part Number	DxH(mm)	Full Angle	FWHM	Holder
Single	LL01CR-ABGxxL02	34 x 15.7		24° 55°	
	LL01CR-ACZxxL02	27.8 x 10.2		24°	
	LL01CR-DGxxL06	28.8 x 16.75	30° 40° 50° 60°		
	LL01CR-NExxL06	19.4 x 14.9	80°		
	LL01CR-PVxxL02	45 x 23.7	45° 60° 80°		
	LL01CR-SQxxL06	19.4 x 12.9	40° 60°		
	LL01CR-WbxxL02	28.8 x 17.4		25° 40°	
	LL01CR-XSxxL06	22.2 x 10.6	40°		
	LL01CR-YJxxL02	19.4 x 12.7	40° 100°		
	LL01CR-ZExxL02	35 x 20.4		20° 45°	
	LL01ED-ACZxxL02	35 x 10.7		24° 38°	
	LL01ED-AJxxL06	28.9 x 19.7	25° 40° 60°		
	LL01ED-AKxxL06	34.4 x 18.8	25° 40°		
	LL01ED-AOxxL06	19.4 x 13.45	60°		
	LL01ED-AQxxL06	22.5 x 10.5	60°		
	LL01ED-ASxxR06	19.9 x 10.55	38° 60°		
	LL01ED-BBxxL06	35.8 x 16.5	60°		
	LL01ED-CYxxL06	26.8 x 18.9	30° 45°		
	LL01NI-GRxxL06	19.45 x 13.5	40° 60° 80°		
	LL01OS-AXxxL02	20 x 11.5	40° 60°		
	LL01OS-BWxxL06	37.2 x 15.35	30°		
	LL01OS-BYxxL06	37.2 x 15.35	30°		
	LL01ZZ-AFLxxL02	22.2 x 10.4		35°	
	LL01ZZ-AHZxxL02	22.2 x 10.6		38°	
	LL01ZZ-FLxxL06	22.2 x 10.6	25° 40° 60°		
	LL01CR-ADTxxL06	35 x 10.65	40°		
	LL01OS-CBxxL06	25.6 x 10	15°		
	3 in 1	LL03CR-AZxxL06	50 x 14.5	45°	
Street Lighting	LL01CR-DL90120L02	26 x 15.8 x 9.15		90°x120° (Asymmetry)	
	LL01CR-OW70130L02	17.4 x 12.75 x 7.2		70°x130° (Asymmetry)	
	LL01CR-XW70140L02	32 x 17.6 x 9.8		70°x140° (Asymmetry)	
	LL01LU-AGV80150L02	32 x 18.5 x 9.5		80°x150° (Asymmetry)	



Oslon Square



OSTAR



W5AM



NVS19A

Type	Part Number	DxH(mm)	Full Angle	FWHM	Holder	Type	Part Number	DxH(mm)	Full Angle	FWHM	Holder	
Single	LL01CR-BRxxL06	19.65 x 12.5	10x45° 15x50° 15x80° 40x90°			Street Lighting	LL04LU-DOxxL06	35 x 10.4		15° 25°		
	LL01CR-B\$xxL06	19.8 x 12.5	60°				4 in 1	LL04LU-GPxxL06	22.2 x 6.8	45°		
	LL01HS-DFxxL02-M2	13.5 x 7.35	80° 100° 30x65°		V			LL04OS-GKxxL06	37 x 9.8	40° 60° 80°		
	LL01XP-DGxxL06-M2	32.8 x 18	20° 30° 40° 50° 60°		V		6 in 1	LL06CR-AXNxxL06-M2	76 x 13		25°	V
	LL01CR-HQxxL06	14.8 x 9.5	15° 40° 60° 80°					LL06ED-ADxxL06	73.3 x 11.5	25° 40° 60°		
	LL01CR-CNExxL06-M2	23.5 x 15.8	17° 25° 40° 60° 80° 10x45° 25x45°		V			LL06CR-AXMxxL06-M2	76 x 13		25°	V
	LL01CR-SQxxL06	19.4 x 12.9	40° 60°				LL06CR-AXLxxL06-M2	76 x 13		25°	V	
	LL01ED-AJxxL06	28.9 x 19.7	40° 60°				7 in 1	LL07ED-GKxxL06	47 x 10.5	40°		
	LL01ED-AKxxL06	34.4 x 18.8	25° 40°					LL07OS-GKxxL06	47 x 9.8	40° 60° 80°		
	LL01ED-AQxxL06	22.5 x 10.45	40°					LL07ZZ-FUxxL06	50.35 x 10.7	25°		
	LL01ED-ASxxL06	19.9 x 10.15	60°				LL07ZZ-FVxxL06	39.2 x 10.6	25° 30° 60°			
	LL01ED-BBxxL06	35.8 x 16.5	60°				9 in 1	LL09ED-BZxxL06	90.75 x 16.5	25°		
	LL01ED-CTxxL06	31 x 11.2	38°					LL09ED-GKxxL06	67 x 10.8	40°		
	LL01ED-CYxxL06	26.8 x 18.9	30° 45°					LL09OS-GKxxL06	67 x 9.8	40° 60° 80°		
	LL01CR-AFCxxL06-M2	21.3 x 12.4	15x60° 20x50°		V		LL09ED-ATxxL06	90.6 x 17.5	40°			
	LL01HS-AAFxxL02-M2	13.5 x 7.35		25° 45° 60°	V		12 in 1	LL12ED-AGxxL06	112 x 13.4	45°		
	LL01NI-ANExxL02-M2	23.5 x 15.8		10° 20° 30°	V			LL12ED-GKxxL06	67 x 10.8	40°		
	LL01NI-GRxxL06	19.45 x 13.5	40° 60° 80°					LL12OS-GKxxL06	67 x 9.8	40° 60° 80°		
	LL01OS-AXxxL02	20 x 11.5	40° 60°				15 in 1	LL15ED-BHxxL06	95 x 11.1	40°		
	LL01OS-BWxxL06	37.2 x 15.35	30°				18 in 1	LL18ED-BlxxL06	110 x 13.1	40°		
	LL01OS-BYxxL06	37.2 x 15.35	30°				24 in 1	LL24ED-ABxxL06	174.5 x 12.7	45°		
	LL01OS-MQxxL06	19.45 x 13.7	40°				36 in 1	LL36ED-AAxxL06	140 x 12.6	45°		
	LL01CR-EXxxL06-M2	22.4 x 9.7	10° 25° 40° 60° 30x65°		V		Street Lighting	LL01CR-APM80150L02	18 x 12.5 x 6.95		80°x150° (Asymmetry)	
	LL01XP-FLxxL06-M2	24.3 x 11.5	25° 40° 30x65°		V			LL01CR-AU85135L02	18 x 10.2 x 6.1		85°x135° (Asymmetry)	
	LL01ED-FMxxL06	19.9 x 10.55	38°					LL01CR-FT60135L02	18 x 9.3 x 5.9		60°x135° (Symmetry)	
	LL01LU-AAxxL06	19.7 x 13.8	20°x65°					LL01CR-KM6090L02	17.55 x 11.6 x 8.6		60°x90° (Symmetry)	
	LL01OS-CBxxL06	25.6 x 10	15°					LL01CR-OW70130L02	17.4 x 12.75 x 7.2		70°x130° (Asymmetry)	
	LL01ZZ-AHAxxL06	50 x 25.4		5°				LL01LU-AIK45135L02	18 x 12.5 x 7.05		45°x135° (Asymmetry)	
	LL03ED-BAxxL06	50.5 x 13	45°					LL01OS-AU60130L02	30.1 x 14.3 x 8.5		60°x130° (Symmetry)	
	LL03ED-GKxxL06	33.2 x 10.2	40°					LL01ZZ-AGX45155L02	18 x 12.5 x 7		45°x155° (Asymmetry)	
LL03LU-DMxxL06	23.1 x 11		15° 25°		LL12ED-VT85160L02	158 x 50 x 9.4			85°x160° (Asymmetry)			
LL03LU-DOxxL06	35 x 10.6		15° 25°		LL24CR-AU75135L02	120 x 100 x 10.2			75°x135° (Asymmetry)			
LL03LU-MKxxL06	23.1 x 11	15° 25°										
LL03NI-QQxxL06	35 x 10.5	25°										
LL03OS-GKxxL06	33.2 x 9.8	25° 60° 80°										
4 in 1	LL04CR-GPxxL06	22.2 x 6.7	38°									
	LL04ED-GKxxL06	37 x 10.3	40°									
	LL04LU-DNxxL06	25.4 x 10.5		15° 25°								



NVS19A



NCS19A

Type	Part Number	DxH(mm)	Full Angle	FWHM	Holder
Single	LL01CR-BRxxL06	19.65 x 12.5	40° 10°x45° 15°x50° 15°x80° 40°x90°		
	LL01HS-DFxxL02-M2	13.5 x 7.35	80° 100° 30°x65°		V
	LL01CR-DGxxL06	28.8 x 16.75	20° 30° 40° 50° 60°		
	LL01CR-HQxxL06	14.8 x 9.6	15° 25° 30° 40° 60° 80°		
	LL01CR-CNExxL06-M2	23.5 x 15.8	17° 25° 40° 60° 80° 25°x45°		V
	LL01CR-SQxxL06	19.4 x 12.9	40° 60°		
	LL01CR-YJxxL02	19.4 x 12.6	40° 60° 80°		
	LL01ED-AJxxL06	28.9 x 19.7	40° 60°		
	LL01ED-AKxxL06	34.4 x 18.8	40°		
	LL01ED-ASxxL06	19.9 x 10.15	60°		
	LL01ED-BBxxL06	35.8 x 16.5	60°		
	LL01ED-CTxxL06	31 x 11.2	38°		
	LL01CR-AFCxxL06-M2	21.3 x 12.4	15°x60°		V
	LL01HS-AAFxxL02-M2	13.5 x 7.35		25°	V
	LL01RP-AAFxxL02-M2	13.5 x 7.35		45° 60°	V
	LL01NI-ANExxL02-M2	23.5 x 15.8		10° 20° 30°	V
	LL01OS-AXxxL02	20 x 11.5	40° 60°		
	LL01OS-MQxxL06	19.45 x 13.7	40° 60°		
	LL01ZZ-EXxxL06	21 x 9.15	10° 25° 40° 60° 30°x65°		
	LL01ZZ-FLxxL06	22.2 x 10.6	25° 40° 60°		
LL01ED-FMxxL06	19.9 x 10.55	35°			
LL01ZZ-AHxxL06	50 x 25.4		5°		
3 in 1	LL03CR-RXxxL06	35 x 9.6	40° 60°		
	LL03ED-BAxxL06	50.5 x 13	45°		
	LL03ED-GKxxL06	33.2 x 10.2	40°		
	LL03ED-UYxxL06	33.2 x 10.3	40°		
	LL03LU-DMxxL06	23.1 x 11		15° 25°	
	LL03LU-DOxxL06	35 x 10.6		15° 25°	
	LL03LU-MKxxL06	23.1 x 11		15° 25°	
4 in 1	LL03NI-QQxxL06	35 x 10.5		25°	
	LL03OS-GKxxL06	33.2 x 9.8		25° 60° 80°	
	LL04CR-RXxxL06	35 x 9.7		40° 60°	
	LL04ED-GKxxL06	37 x 10.3		40°	
	LL04ED-UYxxL06	37 x 10.3		40°	
	LL04LU-DNxxL06	25.4 x 10.5		15° 25°	
	LL04LU-DOxxL06	35 x 10.4		15° 25°	
LL04OS-GKxxL06	37 x 9.8	40° 60° 80°			

Type	Part Number	DxH(mm)	Full Angle	FWHM	Holder
6 in 1	LL06CR-RXxxL06	50 x 9.65	40° 60°		
	LL06ED-ADxxL06	73.3 x 11.5	25° 40° 60°		
	LL06CR-AXMxxL06-M2	76 x 13		15° 25°	V
	LL06CR-AXLxxL06-M2	76 x 13		25°	V
7 in 1	LL07CR-RXxxL06	50 x 10.3	40° 60°		
	LL07ED-GKxxL06	47 x 10.5	40°		
	LL07ED-UYxxL06	47 x 10.3	40°		
	LL07OS-GKxxL06	47 x 9.8	40° 60° 80°		
	LL07ZZ-FUxxL06	50.35 x 10.7		25°	
LL07ZZ-FVxxL06	39.2 x 10.8	30° 60°	25°		
9 in 1	LL09CR-RXxxL06	70 x 10.3	40° 60°		
	LL09ED-GKxxL06	67 x 10.8	40°		
	LL09ED-UYxxL06	67 x 10.3	40°		
	LL09OS-GKxxL06	67 x 9.8	40° 60° 80°		
12 in 1	LL09ED-ATxxL06	90.6 x 17.5	40°		
	LL12CR-RXxxL06	70 x 10.3	40° 60°		
	LL12ED-AGxxL06	112 x 13.4	25°		
	LL12ED-GKxxL06	67 x 10.8	40°		
	LL12ED-UYxxL06	67 x 10.3	40°		
LL12OS-GKxxL06	67 x 9.8	40° 60° 80°			
15 in 1	LL15ED-BHxxL06	95 x 11.1	40°		
18 in 1	LL18ED-BbxxL06	110 x 13.1	25° 40°		
24 in 1	LL24ED-ABxxL06	174.5 x 12.7	45°		
Street Lighting	LL01CR-AU85135L02	18 x 10.2 x 6.1		85°x135° (Asymmetry)	
	LL01CR-FT60135L02	18 x 9.3 x 5.9		60°x135° (Symmetry)	
	LL01CR-KM6090L02	17.55 x 11.6 x 8.6		60°x90° (Symmetry)	
	LL01CR-OW70130L02	17.4 x 12.75 x 7.2		70°x130° (Asymmetry)	
	LL01LU-AIK45135L02	18 x 12.5 x 7.05		45°x135° (Asymmetry)	
	LL01OS-AU60130L02	30.1 x 14.3 x 8.5		60°x130° (Symmetry)	
	LL01ZZ-AGX45155L02	18 x 12.5 x 7		45°x155° (Asymmetry)	
LL24CR-AU75135L02	120 x 100 x 10.2		75°x135° (Asymmetry)		



NCS19A





NVS19B



NVS19B

Type	Part Number	DxH(mm)	Full Angle	FWHM	Holder	Type	Part Number	DxH(mm)	Full Angle	FWHM	Holder	
Single	LL01CR-CRxxL06-M2	13.55 x 7.25	40° 60°		V	4 in 1	LL04CR-RXxxL06	35 x 9.7	40° 60°			
	LL01CR-BMxxL06	35.8 x 15.85	40°				LL04ED-GKxxL06	37 x 10.3	40°			
	LL01CR-BRxxL06	19.65 x 12.5	40° 10x45° 15x50° 15x80° 40x90°				LL04LU-DNxxL06	25.4 x 10.5		15° 25°		
	LL01HS-DFxxL02-M2	13.5 x 7.35	80° 100° 30x65°		V		LL04LU-DOxxL06	35 x 10.4		15° 25°		
	LL01CR-DGxxL06	28.8 x 16.75	20° 30° 40° 50° 60°			5 in 1	LL04OS-GKxxL06	37 x 9.8	40° 60°			
	LL01CR-HQxxL06	14.8 x 9.6	15° 30° 40° 60° 80°				LL05CR-BFRxxL06	35.8 x 6.3	25° 40° 60°			
	LL01CR-CNExxL06-M2	23.5 x 15.8	17° 25° 40° 60° 80° 10x45° 25x45°			V	6 in 1	LL06CR-RXxxL06	50 x 9.65	40° 60°		
	LL01CR-SQxxL06	19.4 x 12.9	40° 60°			LL07CR-BFRxxL06		35.8 x 6.3		25° 40° 60°		
	LL01CR-WIxxL02	28.8 x 17.4	15° 25° 40°			LL07CR-RXxxL06		50 x 10.3	40° 60°			
	LL01CR-XSxxL06	22.2 x 10.6	40°			7 in 1	LL07ED-GKxxL06	47 x 10.5	40°			
	LL01CR-YJxxL02	19.4 x 12.7	80° 100°				LL07OS-GKxxL06	47 x 9.8	40° 60°			
	LL01ED-AFDxxL06	26 x 15.3			20°		LL09CR-RXxxL06	70 x 10.3	40° 60°			
	LL01ED-AJxxL06	28.9 x 19.8	10° 25° 40° 60°			9 in 1	LL09ED-GKxxL06	67 x 10.8	40°			
	LL01ED-ALxxL06	19.7 x 9.9	30x65°				LL09OS-GKxxL06	67 x 10.8	40° 60°			
	LL01ED-ANxxL06	22.6 x 9.9	25°				LL12CR-RXxxL06	70 x 10.3	40° 60°			
	LL01ED-ASxxR06	19.9 x 10.55	38°			12 in 1	LL12ED-GKxxL06	67 x 10.8	40°			
	LL01ED-ASxxL06	19.9 x 10.15	60°				LL12OS-GKxxL06	67 x 9.8	40° 60°			
	LL01ED-BBxxL06	35.8 x 16.5	60°				24 in 1	LL24ED-ABxxL06	174.5 x 12.7	45°		
	LL01ED-CTxxL06	31 x 11.2	38°			LL01CR-AU85135L02		18 x 10.2 x 6.1		85°x135° (Asymmetry)		
	LL01CR-AFCxxL06-M2	21.3 x 12.4	15x60° 20x50°			V		LL01CR-FT60135L02	18 x 9.3 x 5.9		60°x135° (Symmetry)	
	LL01HS-AAFxxL02-M2	13.5 x 7.35			25°	V		LL01CR-KM6090L02	17.55 x 11.6 x 8.6		60°x90° (Symmetry)	
	LL01RP-AAFxxL02-M2	13.5 x 7.35			45° 60°	V	LL01CR-OG85150L02	18 x 8.95 x 6.2		85°x150° (Symmetry)		
	LL01NI-ANExxL02-M2	23.5 x 15.8			10° 20° 30°	V	LL01CR-OW70130L02	17.4 x 12.75 x 7.2		70°x130° (Asymmetry)		
	LL01NI-GRxxL06	19.45 x 13.5	25° 40° 60° 80°				LL01CR-PB70140L02	22.4 x 11.4 x 6.9		70°x140° (Asymmetry)		
	LL01OS-BWxxL06	37.2 x 15.35	30°				LL01LU-AEV50150L02	18 x 12.5 x 6.3		50°x150° (Asymmetry)		
	LL01OS-BYxxL06	37.2 x 15.35	30°				LL01LU-AIK45135L02	18 x 12.5 x 7.05		45°x135° (Asymmetry)		
	LL01OS-MQxxL06	19.45 x 13.7	15° 25° 40° 60°				LL01LU-UQ70140L02	18 x 11 x 6.6		70°x140° (Asymmetry)		
	LL01ZZ-AFLxxL02	22.2 x 10.4			50°		LL01OS-AU60130L02	30.1 x 14.3 x 8.5		60°x130° (Symmetry)		
	LL01CR-EXxxL06-M2	22.4 x 9.7	10° 25° 40° 60° 30x65°			V	LL01OS-AU60140L02	16 x 8.8 x 5.3		60°x140° (Asymmetry)		
	LL01XP-FLxxL06-M2	24.3 x 11.5	10° 25° 40° 60° 30x65°			V	LL14LU-ALY90130L19	250 x 60 x 9.3		90°x130° (Asymmetry)		
	LL01ED-FMxxL06	19.9 x 10.55	38°				LL24CR-AU75135L02	120 x 100 x 10.2		75°x135° (Asymmetry)		
	LL01ED-ZBxxL06	19.6 x 10.4	15°				LL24LU-JT60120L02	126 x 110 x 10.5		60°x120° (Asymmetry)		
	LL01LU-LHxxL06	21 x 9.15	15°				LL24OS-JT110150L02	126 x 110 x 9		110°x150° (Asymmetry)		
	LL01OS-CBxxL06	25.6 x 10	15°				LL28CR-UI65140L14	259.2 x 79.7 x 12.2		65°x140° (Asymmetry)		
LL01ZZ-AHAxxL06	50 x 25.4			5°		LL30CR-PT60140L02	235 x 71 x 9.4		60°x140° (Asymmetry)			
3 in 1	LL03CR-RXxxL06	35 x 9.6	40° 60°									
	LL03ED-GKxxL06	33.2 x 10.2	40°									
	LL03LU-DMxxL06	23.1 x 11	15° 25°									
	LL03LU-DOxxL06	35 x 10.6	15° 25°									
	LL03OS-GKxxL06	33.2 x 9.8	25° 40° 60°									

Street Lighting

■ 757A

Type	Part Number	DxH(mm)	Full Angle	FWHM	Holder
Single	LL01CR-ABGxxL02	34 x 15.7		24°	
	LL01OS-BDFxxL06-M2	13.5 x 7.35	40° 60° 80° 100° 30x65°		V
	LL01CR-DGxxL06	28.8 x 16.75	20° 30° 40° 50°		
	LL01CR-NExxL06	19.4 x 15	17° 40° 60° 80° 10x45°		
	LL01CR-WlxxL02	28.8 x 17.4		25° 40°	
	LL01ED-AJxxL06	28.9 x 19.7	25° 40° 60°		
	LL01ED-AKxxL06	34.4 x 18.8	40°		
	LL01ED-ALxxL06	19.7 x 9.9	30x65°		
	LL01ED-AOxxL06	19.4 x 13.5	40° 60° 80°		
	LL01OS-AFCxxL06-M2	21.3 x 12.4	15x60° 20x50°		V
	LL01OS-AAFxxL02-M2	11.8 x 6.65		25° 45° 60°	
	LL01NI-GRxxL06	19.45 x 13.5	40° 60° 80°		
	LL01OS-MQxxL06-M2	21.05 x 14.75	25° 40° 60°		V
	LL01OS-EXxxL06-M2	22.4 x 9.7	25° 40°		V
	3 in 1	LL01ZZ-FLxxL06	22.2 x 10.6	25° 40° 60°	
LL01LU-AAxxL06		19.7 x 13.8	20°x65°		
LL01NI-DZxxL06		22 x 15.7	20°x40°		
LL03CR-RXxxL06		35 x 9.6	60°		
LL03ED-BCxxL06		43.9 x 9.5	25°		
LL03ED-CTxxL06		31 x 11.2	38° 80°		
LL03ED-GKxxL06		33.2 x 10.2	40° 60° 80°		
LL03CR-HKxxL06		35 x 8.2	40°		
LL03ZZ-EUxxL06		33 x 6.9	38°		
LL03LU-DOxxL06		35 x 10.6	15° 25° 40°		
4 in 1	LL03LU-DMxxL06	23.1x11	15° 25° 40°		
	LL04CR-GPxxL06	22.2 x 6.7	38°		
	LL04CR-RXxxL06	35 x 9.7	60°		
	LL04ED-GKxxL06	37 x 10.3	40°		
	LL04LU-DNxxL06	25.4 x 10.5	25°		
	LL04LU-GPxxL06	22.2 x 6.8	15°		
	LL04NI-DOxxL02	35 x 10.5	25° 40°		
5 in 1	LL04OS-GKxxL06	37 x 9.8	60° 80°		
	LL05CR-BFRxxL06	35.8 x 6.3		25° 40° 60°	
6 in 1	LL06CR-RXxxL06	50 x 9.65	60°		
	LL06ED-ADxxL06	73.3 x 11.5	25° 40°		
7 in 1	LL06CR-AXMxxL06-M2	76 x 13		15° 25°	V
	LL07CR-BFRxxL06	35.8 x 6.3		25° 40° 60°	
	LL07CR-RXxxL06	50 x 10.3	60°		
	LL07ED-GKxxL06	47 x 10.5	40°		
	LL07OS-GKxxL06	67 x 9.8	60° 80°		
9 in 1	LL09CR-RXxxL06	70 x 10.3	60°		
	LL09ED-GKxxL06	67 x 10.8	40°		
	LL09OS-GKxxL06	67 x 9.8	60° 80°		

Type	Part Number	DxH(mm)	Full Angle	FWHM	Holder
12 in 1	LL12CR-RXxxL06	70 x 10.3	60°		
	LL12ED-GKxxL06	67 x 10.8	40°		
	LL12OS-GKxxL06	67 x 9.8	60° 80°		
15 in 1	LL15ED-BHxxL06	95 x 11.1	40°		
18 in 1	LL18ED-BLxxL06	110 x 13.1	40°		
24 in 1	LL24ED-ABxxL06	174.5 x 12.7	45°		
Street Lighting	LL01CR-KM6090L02	17.55 x 11.6 x 8.6		60°x90° (Symmetry)	
	LL01CR-OW70130L02	17.4 x 12.75 x 7.2		70°x130° (Asymmetry)	

■ 383

Type	Part Number	DxH(mm)	Full Angle	FWHM	Holder
Single	LL01CR-DGxxL06	28.8 x 16.75	30° 40° 50° 60°		
	LL01CR-SQxxL06	19.4 x 12.9	60° 80°		
	LL01CR-WlxxL02	28.8 x 17.4		25° 40°	
	LL01CR-XSxxL06	22.2 x 10.6		40°	
	LL01CR-YJxxL02	19.4 x 12.7	60° 80° 100°		
	LL01CR-ZExxL02	35 x 20.4		40°	
	LL01ED-AJxxL06	28.9 x 19.7	40°		
	LL01ED-AKxxL06	34.4 x 18.8	40°		
	LL01ED-BBxxL06	35.8 x 16.5	60°		
	LL01NI-GRxxL06	19.45 x 13.5	60° 80°		
	LL01OS-BWxxL06	37.2 x 15.35	30°		
	LL01OS-BYxxL06	37.2 x 15.35	30°		
	LL01ZZ-AFLxxL02	22.2 x 10.4		35°	
	LL01ZZ-AHZxxL02	22.2 x 10.6		38°	
	LL01ZZ-EXxxL06	21 x 9.3	25° 40° 60° 30x65°		
3 in 1	LL03CR-HKxxL06	35 x 8.2	40°		
6 in 1	LL06CR-AXNxxL06-M2	76 x 13		25°	V
	LL06CR-AXMxxL06-M2	76 x 13		25°	V
12 in 1	LL12ED-AGxxL06	112 x 13.4	45°		
Street Lighting	LL01CR-OW70130L02	17.4 x 12.75 x 7.2		70°x130° (Asymmetry)	
	LL01CR-XW70140L02	32 x 17.6 x 9.8		70°x140° (Asymmetry)	
	LL01LU-AGV80150L02	32 x 18.5 x 9.5		80°x150° (Asymmetry)	
	LL28CR-UI65140L14	259.2 x 79.7 x 12.2		65°x140° (Asymmetry)	
	LL30CR-PT60140L02	235 x 71 x 9.4		60°x140° (Asymmetry)	



383



757A





183A



NSBLL
036
066
121



■ 183A

Type	Part Number	DxH(mm)	Full Angle	FWHM	Holder
Single	LL01CR-BRxxL06	19.65 x 12.5	40° 50°		
	LL01CR-DGxxL06	28.8 x 16.65	30° 40° 60°		
	LL01ED-AJxxL06	28.9 x 19.7	25° 40° 60°		
	LL01ED-AKxxL06	34.4 x 18.8	25° 40°		
	LL01ED-AQxxL06	22.5 x 10.5	40° 60°		
	LL01ED-ASxxL06	19.9 x 10.15	60°		
	LL01ED-BBxxL06	35.8 x 16.5	60°		
	LL01ED-CTxxL06	31 x 11.2	80°		
	LL01ED-CVxxL06	19.6 x 12.3	25° 45°		
	LL01NI-GRxxL06-M2	23.5 x 14.9	40° 60° 80°		V
	LL01OS-AXxxL02	20 x 11.5	40° 60°		
	LL01OS-BWxxL06	37.2 x 15.35	30°		
	LL01OS-BYxxL06	37.2 x 15.35	30°		
	LL01ZZ-EXxxL06	21 x 9.3	25° 40°		
	LL01ZZ-FLxxL06	22.2 x 10.6	25° 40° 30°x65°		
	LL01ED-FMxxL06	19.9 x 10.55	38°		
	LL01OS-CBxxL06	25.6 x 10	15°		
	Single	LL01NI-AAFxxL02-M2	13.5 x 7.35		45° 60°
LL01NI-ANExxL02		19.4 x 14.94		20° 30°	
LL01LU-LHxxL06		21 x 9.15	15°		
3 in 1	LL03ED-BAxxL06	50.5 x 13	45° 60°		
	LL03CR-EKxxL06	35 x 9	40° 60°		
	LL03ED-AFxxL06	50.5 x 20	30° 45°		
	LL03CR-CExxL06	34 x 9.9	38°		
6 in 1	LL03ZZ-EUxxL06	33 x 6.9	38°		
	LL06ED-ATxxL06	73.2 x 13.5	40°		
	LL06ED-DKxxL06	73.2 x 13.7	60°		
6 in 1	LL06CR-CKxxL06	73.2 x 13.5	25°		
	LL06ED-ADxxL06	73.3 x 11.5	40° 60°		
	LL06ED-AExxL06	73.3 x 13.5	25° 40°		
9 in 1	LL09ED-BZxxL06	90.75 x 16.5	25°		
	LL09ED-ATxxL06	90.6 x 17.5	40°		
12 in 1	LL12ED-AGxxL06	112 x 13.4	45°		
15 in 1	LL15ED-BHxxL06	95 x 11.1	40°		
18 in 1	LL18ED-BIxxL06	110 x 13.1	40°		
60 in 1	LL60ED-BOxxL06	180 x 13.1	45°		
Street Lighting	LL01OS-AU60130L02	30.1 x 14.3 x 8.5		60°x130° (Symmetry)	

■ NSBLL036

Type	Part Number	DxH(mm)	Full Angle	FWHM	Holder
Single	LL01CR-ABGxxL02	34 x 15.7		24° 38° 55°	
	LL01CR-ABHxxL02	50 x 10.4		40° 60°	
	LL01ED-ABYxxL02	44 x 14.1		24°	
	LL01CR-AQHxxL02	44 x 14.1		38° 45°	
Reflector	LL01CT-AJZxxR49	50 x 19		55°	
	LL01CT-ALNxxR49	75.8 x 20.1		38° 45°	
	LL01CT-AMXxxR49	44 x 11.8		45°	
	LL01ED-AJMxxR49	35.2 x 7.8		24° 38°	
	LL01ED-AKVxxR49	50 x 29.5		36°	
	LL01ED-AKYxxR49	50.5 x 30		38° 45°	
	LL01ED-ALAXxxR49	75 x 20.1		24°	
	LL01ED-ALixxxR49	50 x 19		24° 38° 55°	
	LL01SP-ATHxxR49	75 x 40		15° 24° 38°	
	LL01ZZ-AAAxL49	70 x 35		38° 55°	

■ NSBLL066

Type	Part Number	DxH(mm)	Full Angle	FWHM	Holder
Single	LL01CR-BAYxxL06	75.8 x 22.5		24° 38°	
	LL01CT-AMYxxL06	75.8 x 23		24°	
	LL01ED-ABXxxL06	75.8 x 24.35		24°	
Reflector	LL01CT-ALNxxR49	75.8 x 20.1		24° 38°	
	LL01ED-AKAXxxR49	85 x 23.5		60°	
	LL01ED-ALAXxxR49	75 x 20.1		38°	
	LL01SP-ASOxxR49	90 x 50		15° 24° 38° 55°	
	LL01SP-ATHxxR49	75 x 40		15° 24° 38°	
	LL01ZZ-AAAxL49	70 x 35		38° 55°	

■ NSBLL 121

Type	Part Number	DxH(mm)	Full Angle	FWHM	Holder
Single	LL01ED-ASAxL02-P	90.6 x 22		12° 24° 38°	
	LL01ED-ASAxL06-P	90.6 x 22		12° 24° 38°	
Reflector	LL01ED-AKAXxxR49	85 x 23.5		60°	
	LL01ED-AKXxxR49	116 x 32		24° 38°	
	LL01ED-ALJxxR49	91.5 x 23.2		38° 45°	
	LL01SP-ASOxxR49	90 x 50		15° 24° 38° 55°	
	LL01SP-ATHxxR49	75 x 40		15° 24° 38°	
	LL01ZZ-AAAxL49	70 x 35		38° 55°	



CLL010/012



CLL020/022



CLL030/032



CLL040



CLL430



■ **CLL010/012**

Type	Part Number	DxH(mm)	Full Angle	FWHM	Holder
Single	LL01CR-ABGxxL02	34 x 15.7		38° 55°	
	LL01ED-ABYxxL02	44 x 14.1		24°	
	LL01CR-AQHxxL02	44 x 14.1		38° 45°	
	LL01CR-DGxxL06	28.8 x 16.75	20° 50°		
	LL01ED-AYxxL06	43.8 x 24.5	10° 38°		
Reflector	LL01BR-TYRxxR34-P	45 x 19.4		24° 34° 50°	
	LL01CT-AJZxxR49	50 x 19		38° 55°	
	LL01CT-AMXxxR49	44 x 11.8		45°	V
	LL01ED-AJMxxR49	35.2 x 7.8		24° 38°	

■ **CLL030/032**

Type	Part Number	DxH(mm)	Full Angle	FWHM	Holder
Single	LL01CR-ABHxxL02	50 x 10.4		40° 60°	
	LL01CR-BAYxxL06	75.8 x 22.5		24° 38°	
	LL01CT-AMYxxL06	75.8 x 23		24° 38°	
	LL01CT-APGxxL06-M2	90.8 x 22		24° 38°	V
	LL01CT-AZNxxL02-P	88.5 x 15		15° 24° 38°	V
	LL01ED-ABXxxL06	75.8 x 24.35		24° 38°	
	LL01ED-ASAxxL02-P	90.6 x 22		12° 24°	
	LL01ED-ASAxxL06-P	90.6 x 22		12° 24° 38°	
	LL01BR-TYRxxR34-P	45 x 19.4		24° 34° 50°	
	LL01CIOTxxR2-P	50 x 30		20° 33° 45°	V
Reflector	LL01CT-ALOxxR49	90.5 x 23.2		24° 38° 55°	V
	LL01CT-AYXxxR35-P	90 x 50		15° 24° 38°	V
	LL01ED-AKAxxR49	85 x 23.5		60°	
	LL01ED-AKXxxR49	116 x 32		24° 38°	
	LL01ED-ALAxxR49	75 x 20.1		24° 38°	
	LL01ED-ALJxxR49	91.5 x 23.2		24° 38° 45°	
	LL01SP-ASOxxR49	90 x 50		15° 24° 38° 55°	
	LL01ZZ-AAAxL49	70 x 35		24° 38° 55°	
	LL01CT-BKYxxR49-BLBxxL51	93 x 35		15° 24° 36° 75°	

■ **CLL040**

Type	Part Number	DxH(mm)	Full Angle	FWHM	Holder
Single	LL01CT-AMYxxL06	75.8 x 23		24° 38°	
	LL01ED-ABXxxL06	75.8 x 24.35		24° 38°	
	LL01ED-ASAxxL06-P	90.6 x 22		12° 24° 38°	

■ **CLL020/022**

Type	Part Number	DxH(mm)	Full Angle	FWHM	Holder
Single	LL01CR-ABHxxL02	50 x 10.4		60°	
	LL01CR-BAYxxL06	75.8 x 22.5		24° 38°	
	LL01CR-PVxxL02	45 x 23.7	45° 60° 80°		
	LL01ZZ-AOFxxL06-M2	74.4 x 13		24° 38°	V
	LL01CT-AZWxxL02-P	76.1 x 12.7		24° 38°	V
	LL01CT-BBXxxL06	69 x 22.7		24° 38°	
	LL01ED-ABXxxL06	75.8 x 24.35		38°	
	LL01ED-ASAxxL06-P	90.6 x 22		12° 24° 38°	
	LL01ED-AYxxL06	43.8 x 24.5	10° 38°		
	LL01CT-BBXxxL06	69 x 22.7		24° 38°	
	LL01BR-TYRxxR34-P	45 x 19.4		24° 34° 50°	
	LL01CT-AJZxxR49	50 x 19		38° 55°	
	LL01CT-ALNxxR49	75.8 x 20.1		38° 45°	V
	LL01CT-AMXxxR49	44 x 11.8		45°	
	LL01CT-AYTxxR35-P	75 x 45		15° 24° 38°	V
Reflector	LL01ED-AKVxxR49	50.5 x 29.5		36°	
	LL01ED-AKYxxR49	50 x 30		38° 45°	
	LL01ED-ALAxR49	75 x 20.1		24° 38°	
	LL01ED-ALJxxR49	50 x 19		24° 38° 55°	
	LL01SP-ATHxxR49	75 x 40		15° 24° 38°	
	LL01TJ-AONxxR49	50 x 20		60°	
	LL01ZZ-AAAxL49	70 x 35		24° 38° 55°	

■ **CLL430**

Type	Part Number	DxH(mm)	Full Angle	FWHM	Holder
Single	LL01CR-ABHxxL02	50 x 10.4		60°	
	LL01CR-PVxxL02	45 x 23.7	45° 60° 80°		
	LL01CT-AOFxxL06	74.4 x 13		24° 38°	
	LL01ED-ASAxxL06-P	90.6 x 22		12° 24° 38°	
	LL01ED-AYxxL06	43.8 x 24.5	10° 38°		
	LL01BR-TYRxxR34-P	45 x 19.4		24° 34° 50°	
Reflector	LL01CT-AJZxxR49	50 x 19		38° 55°	
	LL01CT-ALNxxR49	75.8 x 20.1		38° 45°	
	LL01CT-AMXxxR49	44 x 11.8		45°	
	LL01CT-AYTxxR35-P	75 x 45		15° 24° 38°	
	LL01ED-AKVxxR49	50.5 x 29.5		36°	
	LL01ED-AKYxxR49	50 x 30		38° 45°	
	LL01ED-ALAxR49	75 x 20.1		24° 38°	
	LL01ED-ALJxxR49	50 x 19		24° 38° 55°	
	LL01SP-ATHxxR49	75 x 40		15° 24° 38°	
	LL01TJ-AONxxR49	50 x 20		60°	
	LL01ZZ-AAAxL49	70 x 35		24° 38° 55°	

SHARP

Petite
Zenigata



Mini
Zenigata



■ Petite Zenigata

Type	Part Number	DxH(mm)	Full Angle	FWHM	Holder
Single	LL01CR-ACZxxL02	27.8 x 10.2		24° 38°	
	LL01ED-ABYxxL02	44 x 14.1		24°	
	LL01CR-AQHxxL02	44 x 14.1		38° 45°	
	LL01CR-BEXxxL06	20.9 x 9.2		25°	
	LL01CR-DGXxxL06	28.8 x 16.75	20° 30° 40° 50° 60°		
	LL01CR-WlxxL02	28.8 x 17.4		25° 40°	
	LL01CR-XSxxL06	22.2 x 10.6	40°		
	LL01ED-ACZxxL02	35 x 10.7		24° 38°	
	LL01ED-AFDxxL06	26 x 15.5		15° 20°	
	LL01ED-AJxxL06	28.9 x 19.7	25° 40° 60°		
	LL01ED-AQxxL06	22.5 x 10.5	40° 60°		
	LL01ED-ASxxL06	19.9 x 10.55	38°		
	LL01ED-ASxxR06	19.9 x 10.55	38°		
	LL01ED-ASxxL06	19.9 x 10.15	60°		
	LL01ED-CVxxL06	19.6 x 12.3	15° 25° 45°		
	LL01ED-CYxxL06	26.8 x 19.3	30° 45° 30x65°		
	LL01OS-AXxxL02	20 x 11.5	20° 40° 60°		
	LL01ZZ-AFLxxL02	22.2 x 10.4		35° 50°	
	LL01ZZ-EXxxL06	21 x 9.15	40° 30x65°		
	LL01ZZ-FLxxL06	22.2 x 10.6	25° 40° 60°		
LL01SP-AVA40L06	42 x 9.65		40°		
Reflector	LL01CT-AMXxxR49	44 x 11.8		45°	
	LL01ED-AJMxxR49	35.2 x 7.8		38°	

■ Mini Zenigata

Type	Part Number	DxH(mm)	Full Angle	FWHM	Holder	
Single	LL01CR-ABHxxL02	50 x 10.4		40° 60°		
	LL01CR-BAYxxL06	75.8 x 22.5		24° 38°		
	LL01CR-PVxxL02	45 x 23.7	45° 60° 80°			
	LL01CR-ZExxL02	35 x 20.4		20° 30° 45°		
	LL01CT-AMYxxL06	75.8 x 23		24°		
	LL01CT-AOFxxL06	74.4 x 13		24° 38°		
	LL01CT-APGxxL06	84.6 x 18		24° 38°		
	LL01ED-ABXxxL06	75.8 x 24.35		24° 38°		
	LL01ED-ASAxxL06-P	90.6 x 22		24° 38°		
	LL01SP-AVA40L06	42 x 9.65		40°		
	Reflector	LL01BR-TYRxxR34-P	45 x 19.4		24° 34° 50°	
		LL01CIOTxxR2-P	50 x 30		20° 33° 45°	
LL01CT-AJZxxR49		50 x 19		38° 55°		
LL01CT-ALNxxR49		75.8 x 20.1		38° 45°		
LL01CT-ALOxxR49		90.5 x 23.2		24° 38° 45°		
LL01CT-AMXxxR49		44 x 11.8		45°		
LL01ED-AJMxxR49		35.2 x 7.8		24° 38°		
LL01ED-AKAxxR49		85 x 23.5		60°		
LL01ED-AKVxxR49		50.5 x 29.5		36°		
LL01ED-AKYxxR49		50 x 30		24° 38° 45°		
LL01ED-ALlxxR49		50 x 19		24° 38° 55°		
LL01ZZ-AAAxL49		70 x 35		24° 38° 55°		

■ Mega Zenigata

Type	Part Number	DxH(mm)	Full Angle	FWHM	Holder
Single	LL01CR-BAYxxL06	75.8 x 22.5		24° 38°	
	LL01CT-AMYxxL06	75.8 x 23		24°	
	LL01CT-AOFxxL06	74.4 x 13		24° 38°	
	LL01CT-APGxxL06	84.6 x 18		24° 38°	
	LL01ED-ABXxxL06	75.8 x 24.35		24° 38°	
	LL01ED-ASAxxL06-P	90.6 x 22		24° 38°	
	LL01SP-AVA40L06	42 x 9.65		40°	
Reflector	LL01BR-TYRxxR34-P	45 x 19.4		24° 34° 50°	
	LL01CIOTxxR2-P	50 x 30		20° 33° 45°	
	LL01CT-ALOXxxR49	90.5 x 23.2		24° 38° 45°	
	LL01ED-AKAXxxR49	85 x 23.5		60°	
	LL01ED-AKXxxR49	116 x 32		24° 38°	
	LL01ED-ALAXxxR49	75 x 20.1		24° 38°	
	LL01ED-ALJxxR49	91.5 x 23.2		24° 38° 45°	
	LL01SP-ASOXxxR49	90 x 50		15° 24° 38° 55°	V
	LL01SP-ATHxxR49	75 x 40		15° 24° 38°	V
	LL01ZZ-AAAXxL49	70 x 35		38° 55°	



1LA5



1LA5



Type	Part Number	DxH(mm)	Full Angle	FWHM	Holder
Single	LL01CR-BRxxL06	19.65 x 12.5	30° 40° 50° 40x90°		
	LL01CR-DGxxL06	28.8 x 16.75	30° 40° 50° 60°		
	LL01ED-AHxxL06-M2	21.3 x 14	30° 45° 60°		V
	LL01ED-AJxxL06-M2	31 x 19.3	10° 25° 40° 60°		V
	LL01ED-AKxxL06	34.4 x 18.8	25° 40°		
	LL01ED-ALxxL06-M2	21.3 x 14	15° 30x65°		V
	LL01ED-ANxxL06-M2	25 x 13.5	15x50°		V
	LL01ED-AOxxL06-M2	23.5 x 17.5	30° 40° 60° 80° 25x45°		V
	LL01ED-BAxxL06-M2	26.6 x 12.8	15° 40° 60°		V
	LL01ED-ASxxL06-M2	21.9 x 12.3	15° 38° 60°		V
	LL01ED-BBxxL06	35.8 x 16.5	25° 40° 60°		
	LL01ED-CTxxL06	31 x 11.2	38° 80°		
	LL01ED-CVxxL06-M2	21.5 x 15.0	15° 25° 45°		V
	LL01OS-AXxxL02	20 x 11.5	40° 60°		
	LL01OS-BWxxL06	37.2 x 15.35	30°		
	LL01OS-BYxxL06	37.2 x 15.35	30°		
	LL01ZZ-EXxxL06	21 x 8.75	25°		
	LL01ZZ-FLxxL06	22.2 x 10.6	25° 40°		
	LL01ED-BJxxL06	19.7 x 11.9	38°		
	LL01ED-BPxxL06-M2	21.3 x 14	45°		V
	LL01ED-BV60L06-M2	21.3 x 14	60°		V
	LL01ED-FMxxL06	19.9 x 10.55	38°		
	LL01ED-IHxxL06	87 x 44.25	60°		
	LL01ED-ZBxxL06	19.6 x 10.4	15°		
	LL01LU-AAxxL06	19.7 x 13.8	20°x65°		
	LL01OS-CBxxL06	25.6 x 10	15°		
	LL01ZZ-AHAxxL06	50 x 25.4		5°	
	3 in 1	LL03ED-AFxxL06	50.5 x 20	30° 45° 60° 40x70°	
LL03ED-ASxxL06		37.7 x 10.5	38°		
LL03ED-AZxxL06		50.5 x 13	25° 45° 60°		
LL03ED-BAxxL06		50.5 x 13	25° 45° 60°		

Type	Part Number	DxH(mm)	Full Angle	FWHM	Holder
3 in 1	LL03ED-CTxxL06	31 x 11.2	38° 80°		
	LL03ED-EKxxL06	35 x 9.2	25° 40° 60°		
	LL03ED-AIHxxL06	37 x 8.7	30°		
	LL03ED-ALlxxL06	34.9 x 10.4	30°		
6 in 1	LL06CR-AXNxxL06-M2	76 x 13		25°	V
	LL06ED-ADxxL06	73.3 x 11.5	8° 25° 40° 60°		
	LL06CR-AXMxxL06-M2	76 x 13		15° 25° 35°	V
9 in 1	LL06CR-AXLxxL06-M2	76 x 13		25°	V
	LL09ED-ACxxL06	95.4 x 13.5	15° 25°		
	LL09ED-BZxxL06	90.75 x 16.5	15° 25°		
	LL09ED-ATxxL06-M2	90.6 x 17.5	40°		V
12 in 1	LL09ED-BQxxL06	90.6 x 16.5	25° 60°		
	LL12ED-AGxxL06	112 x 13.4	25° 45°		
	LL12ED-BGxxL06	95 x 11.2	15° 25° 40°		
15 in 1	LL12ED-BQxxL06	90.6 x 16.6	25°		
	LL15ED-BHxxL06	95 x 11.1	15° 25° 40°		
18 in 1	LL18ED-BlxxL06	110 x 13.1	15° 25° 40°		
24 in 1	LL24ED-ABxxL06	174.5 x 12.7	15° 25° 40°		
36 in 1	LL36ED-AAxxL06	140 x 12.6	15° 25° 45°		
60 in 1	LL60ED-BOxxL06	180 x 13.1	25° 45°		
Street Lighting	LL01ED-AU40130L02	18.95 x 14.8 x 8.25		40°x130° (Asymmetry)	
	LL01ED-AU50130L02	30 x 11 x 11.4		50°x130° (Symmetry)	
	LL01ED-AU70135L02	24 x 12.3 x 9.2		70°x135° (Symmetry)	
	LL01ED-LP70130L02	20 x 11.7 x 6.9		70°x130° (Asymmetry)	
	LL01ED-ZP55140L02	19.15 x 10.8 x 9.4		55°x140° (Asymmetry)	
	LL01SH-AU75135L02	24 x 13.2 x 9.6		75°x135° (Symmetry)	
	LL04LZ-NO85140L02	160 x 25 x 9.55		85°x140° (Asymmetry)	
	LL12ED-VT85160L02	158 x 50 x 9.4		85°x160° (Asymmetry)	
	LL24ED-AU75135L02	135 x 112 x 9.6		75°x135° (Asymmetry)	



EdiPower II
EPCX-HR96
EPSX-HRB8
EPSX-HRBF
EPSX-HRBJ



■ **EdiPower II EPCX-HR96**

Type	Part Number	DxH(mm)	Full Angle	FWHM	Holder
Single	LL01CR-ABHxxL02	50 x 10.4		40° 60°	
	LL01ZZ-AOFxxL06-M2	76.4 x 16.7		24° 38°	V
	LL01ED-ABXxxL06	75.8 x 24.35		24° 38°	
	LL01ED-IHxxL06	87 x 44.25	60°		
	LL01CR-BAAXxL02	74 x 3		24°	
Reflector	LL01BR-TYRxxR34-P	45 x 19.4		24° 34° 50°	
	LL01ED-AKY24R49	50.5 x 30		24° 38° 45°	
	LL01ED-ALI24R49	50 x 19		24° 38° 55°	
	LL01ZZ-AAA24L49	70 x 35		24° 38° 55°	

■ **EdiPower II EPSX-HRB8**

Type	Part Number	DxH(mm)	Full Angle	FWHM	Holder
Single	LL01ZZ-AOFxxL06-M2	76.4 x 16.7		24° 38°	V
	LL01CT-APGxxL06	84.6 x 18		24° 38°	
	LL01ED-ABXxxL06	75.8 x 24.35		24° 38°	
	LL01ED-ASAxxL06-P	90.6 x 22		24° 38°	
	LL01ED-IHxxL06	87 x 44.25	60°		
Reflector	LL01CT-ALOxxR49	90.5 x 23.2		24° 45°	
	LL01ED-AKAxxR49	85 x 23.5		60°	
	LL01ED-AKVxxR49	50 x 29.5		36°	
	LL01ED-ALAxxR49	75 x 20.1		24° 38°	

■ **EdiPower II EPSX-HRBF**

Type	Part Number	DxH(mm)	Full Angle	FWHM	Holder
Single	LL01CT-APGxxL06-M2	90.8 x 22		24° 38°	V
	LL01ED-ABXxxL06	75.8 x 24.35		24° 38°	
	LL01ED-ASAxx06-P	90.6 x 22		24° 38°	
	LL01ED-IHxxL06	87 x 44.25	60°		
Reflector	LL01ED-AKAxxR49	85 x 23.5		60°	
	LL01ED-AKXxxR49	116 x 32		24° 38°	
	LL01ED-ALJxxR49	91.5 x 23.2		45°	

■ **EdiPower II EPSX-HRBJ**

Type	Part Number	DxH(mm)	Full Angle	FWHM	Holder
Single	LL01CT-APGxxL06-M2	84.6 x 18		24° 38°	V
	LL01ED-ABXxxL06	75.8 x 24.35		24° 38°	
	LL01ED-ASAxxL06-P	90.6 x 22		24° 38°	
	LL01ED-IHxxL06	87 x 44.25	60°		
Reflector	LL01ED-AKAxxR49	85 x 23.5		60°	
	LL01ED-AKXxxR49	116 x 32		24° 38°	

Federal 3535

Type	Part Number	DxH(mm)	Full Angle	FWHM	Holder
Single	LL01CR-BRxxL06	19.65 x 12.5	40°		
	LL01HS-DFxxL02-M2	13.5 x 7.35	100°		V
	LL01CR-DGxxL06	28.8 x 16.75	30° 40° 50° 60°		
	LL01CR-HQxxL06	14.8 x 9.5	40° 60°		
	LL01CR-NExxL06	19.4 x 15	25° 40° 60° 10x45° 25x45°		
	LL01CR-OTxxL06	15 x 9.7	40° 60° 80°		
	LL01ED-AKxxL06	34.4 x 18.8	25° 40°		
	LL01NI-GRxxL06	19.45 x 13.5	60°		
	LL01OS-BYxxL06	37.2 x 15.35	30°		
	LL01OS-MQxxL06	19.45 x 13.7	40°		
	LL01CR-EXxxL06-M2	22.4 x 9.7	40° 60°		V
	LL01ED-FMxxL06	19.9 x 10.55	38°		
3 in 1	LL03CR-AZxxL06	50 x 14.5	25° 45°		
	LL03CR-RXxxL06	35 x 9.6	40° 60°		
	LL03LU-DMxxL06	23.1 x 11	25° 40°		
	LL03LU-DOxxL06	35 x 10.6	25° 40°		
4 in 1	LL04CR-RXxxL06	35 x 9.7	40° 60°		
	LL04LU-DNxxL06	25.4 x 10.5		25° 40°	
	LL04LU-DOxxL06	35 x 10.4		25° 40°	
	LL04LU-GPxxL06	22.2 x 6.8	45°		
6 in 1	LL06CR-RXxxL06	50 x 9.65	40° 60°		
	LL06CR-AXLxxL06-M2	76 x 13		25°	V
7 in 1	LL07CR-RXxxL06	50 x 10.3	40° 60°		
	LL07ZZ-FUxxL06	50.35 x 10.7	25°		
	LL07ZZ-FVxxL06	39.2 x 10.8	25° 30°		
9 in 1	LL09CR-RXxxL06	70 x 10.3	40° 60°		
12 in 1	LL12CR-RXxxL06	70 x 10.3	40° 60°		
18 in 1	LL18ED-BlxxL06	110 x 13.1	40°		



Federal 3535



Ceramic3535

Type	Part Number	DxH(mm)	Full Angle	FWHM	Holder
Single	LL01CR-AAFxxL02	11.8 x 6.65		25°	
	LL01CR-DFxxL06	11.8 x 6.65	25° 40° 60° 80° 100° 30°x65°		
	LL01NI-AAFxxL02	11.8 x 6.5		45° 60°	
	LL01CR-HQxxL06	14.8 x 9.6	15° 25° 30° 40° 60° 80° 25°x45°		
	LL01CR-OTxxL06	15 x 9.7	25° 40° 60° 80°		
	LL01CR-BNExxL06	19.4 x 14.6		25° 40° 60° 35°x70°	
	LL01CR-NExxL06	19.4 x 15	15° 17° 25° 40° 60° 80° 10°x45° 25°x45°		
	LL01CR-SQxxL06	19.4 x 12.9	40° 60° 80°		
	LL01CR-YJxxL02	19.4 x 12.7	40° 60° 80° 100°		
	LL01LU-AFCxxL06	19.4 x 11.8		10°x35° 15°x30°	
	LL01NI-ANExxL02	19.4 x 14.94		10° 20° 30°	
	LL01OS-AFCxxL06	19.4 x 11.43		15° 25° 30°	
	LL01ED-CVxxL06	19.6 x 12.3	15°		
	LL01CR-BRxxL06	19.65 x 12.5	30° 40° 50° 15°x50° 15°x80° 40°x90°		
	LL01CR-BSxxL06	19.8 x 12.5	10° 38° 60°		
	LL01OS-BFVxxL06	20.8 x 12.35		15° 25° 30°	
	LL01CR-BEXxxL06	20.9 x 9.2		60°	
	LL01ZZ-EXxxL06	21 x 9.3	10° 25° 40°		
	LL01CR-XSxxL06	22.2 x 10.4	25° 40°		
	LL01ZZ-AFLxxL02	22.2 x 10.4		35° 50°	
	LL01ZZ-FLxxL06	22.2 x 10.6	10° 25° 60° 30°x65°		
	LL01CR-DGxxL06	28.8 x 16.75	20° 30° 40° 50° 60°		
	LL01CR-WIxxL02	28.8 x 17.4	15° 25° 40°		
	LL01CR-ZExxL02	35 x 20.4	20° 30° 45°		
	LL01CR-BMxxL06	35.8 x 15.85	15° 40°		
	LL01CR-PVxxL02	45 x 23.7	45° 60°		
	LL01CT-AOFxxL06	74.4 x 13		24° 38°	
	LL01CT-AMYxxL06	76 x 23		24° 38°	
	LL01CT-AZWxxL02-P	76.1 x 12.7		15° 24° 38°	
	LL01CT-APGxxL06	84.6 x 18		24° 38°	
	LL01CT-AZNxxL02-P	88.5 x 15		15° 24° 38°	

Type	Part Number	DxH(mm)	Full Angle	FWHM	Holder
3 in 1	LL03LU-DMxxL06	23.1 x 11	15° 25°		
	LL03ED-CTxxL06	31 x 11.2	38°		
	LL03ED-GKxxL06	33.2 x 10.2	25° 40°		
	LL03CR-RXxxL06	35 x 9.6	40° 60°		
	LL03LU-DOxxL06	35 x 10.6	15° 25°		
4 in 1	LL04CR-GPxxL06	22.2 x 6.7	25° 38° 45°		
	LL04LU-GPxxL06	22.2 x 6.8	15° 25° 45°		
	LL04CR-RXxxL06	35 x 9.7	40° 60°		
	LL04LU-DOxxL06	35 x 10.4	15° 25°		
	LL04ED-GKxxL06	37 x 10.3	25° 40°		
LL04LU-DNxxL06	25.4 x 10.5	15° 25°			
6 in 1	LL06CR-RXxxL06	50 x 9.65	40° 60°		
7 in 1	LL07CR-RXxxL06	50 x 10.3	40° 60°		
	LL07ED-GKxxL06	47 x 10.2	25° 40°		
9 in 1	LL09CR-RXxxL06	70 x 10.3	40° 60°		
	LL09ED-GKxxL06	67 x 10.8	25° 40°		
12 in 1	LL12ED-GKxxL06	67 x 10.2	25° 40°		
	LL12CR-RXxxL06	70 x 10.3	40° 60°		
Street Lighting	LL01CR-APM80150L02	18 x 12.5 x 6.95		80°x150° (Asymmetry)	
	LL01CR-AU85135L02	18 x 10.2 x 6.1		85°x135° (Asymmetry)	
	LL01CR-FT60135L02	18 x 9.3 x 5.9		60°x135° (Symmetry)	
	LL01CR-KM6090L02	17.55 x 11.6 x 8.6		60°x90° (Symmetry)	
	LL01CR-OG85150L02	18 x 8.95 x 6.2		85°x150° (Symmetry)	
	LL01CR-OW70130L02	17.4 x 12.75 x 7.2		70°x130° (Asymmetry)	
	LL01CR-PB70140L02	22.4 x 11.4 x 6.9		70°x140° (Asymmetry)	
	LL01LU-AIK45135L02	18 x 12.5 x 7.05		45°x135° (Asymmetry)	
	LL01LU-NI75140L02	15.7 x 14 x 5.8		75°x140° (Asymmetry)	
	LL01LU-UQ70140L02	18 x 11 x 6.6		70°x140° (Asymmetry)	
	LL01OS-AU60130L02	30.1 x 14.3 x 8.5		60°x130° (Symmetry)	
	LL01OS-AU60140L02	16 x 8.8 x 5.3		60°x140° (Asymmetry)	
	LL01ZZ-AGX45155L02	18 x 12.5 x 7		45°x155° (Asymmetry)	





P4



P4

Type	Part Number	DxH(mm)	Full Angle	FWHM	Holder	Type	Part Number	DxH(mm)	Full Angle	FWHM	Holder
Single	LL01ED-AP70L06-M2	24.6x19.4	60°		V	6 in 1	LL06CR-AXNxxL06-M2	76 x 13		25°	V
	LL01CR-BRxxL	19.6x12.5	40°				LL06ED-ADxxL	73.3x13.9	25° 40° 60°		
	LL01CR-DGxxL	28.8x16.5	30° 40°				LL06CR-AXMxxL06-M2	76 x 13		15° 25° 35°	V
	LL01ED-AJxxL06-M2	31x19.3	25° 40° 60°		V		LL06CR-AXLxxL06-M2	76 x 13		25°	V
	LL01ED-AKxxL	34.6x18.7	25° 40°				LL06ED-BExxL	43.9x8.5	25°		
	LL01ED-BAxxL06-M2	26.6x12.8	40° 60°		V	7 in 1	LL07ED-BFxxL	43.9x8.6	25°		
	LL01ED-BBxxL	35.8x15.9	40°			9 in 1	LL09ED-ACxxL	95x12.8	25°		
	LL01ED-CTxxL	31x11.2	38° 80°				LL09ED-ATxxL06-M2	90.6x16.5	40°		V
	LL01ED-CVxxL02-M2	21.5x15.0	25° 45°		V	LL09ED-BZxxL	90.6x16.5	25°			
	LL01ED-FM38L06-M2	21.9x12.3	38°		V	12 in 1	LL12ED-AGxxL	122x13.5	45°		
	LL01OS-AXxxL	19.7x11.5	40° 60°				LL12ED-BGxxL	95x11.2	25° 40°		
	LL01OS-BWxxL	37.2x15.4	30°			LL12ED-BQxxL	91x17	25°			
	LL01OS-BYxxL	37.2x15.4	30°			15 in 1	LL15ED-BHxxL	95x11.1	25° 40°		
	LL01OS-CBxxL	25.6x10			15°	18 in 1	LL18ED-BIxxL	110x13.1	25° 40°		
	LL01SE-BSxxL	19.9x11.6	38°			24 in 1	LL24ED-ABxxL	174.5x12.5	25° 45°		
LL01ZZ-EXxxL	21x9.3	40° 60°			36 in 1	LL36ED-AAxxL	140x12.7	25° 45°			
LL01ZZ-FLxxL	22x10.6	25°			60 in 1	LL60ED-BOxxL	180x13.1	25°			
3 in 1	LL03CR-CExxL	34x9.9	38°			Street Lighting	LL01ED-AU50130L	30x10.4x10.1		50°x130° (Symmetry)	
	LL03ED-AFxxL	50.5x19.6	45° 60°				LL01ED-AU70135L	24x12.3x9.2		70°x135° (Symmetry)	
	LL03ED-AZxxL	50.5x13	45° 60°				LL01SH-AU75135L	24x12.6x9.3		75°x135° (Symmetry)	
	LL03ED-BAxxL	50.5x13	45° 60°			Oval Lens	LL01ED-AL3065L	19.7x9.9	30°x65°		
	LL03ED-CExxL	34x9.9	38°				LL01LU-AA2065L	19.7x13.8	20°x65°		
LL03ED-CTxxL	31x11.2	38° 80°			LL01NI-DZ2040L	22x13.9		20°x40°			
4 in 1	LL04ED-BDxxL	43.9x9.7	40°								

Type	Part Number	DxH(mm)	Full Angle	FWHM	Holder
Single	LL01CR-BMxxL06	19.4x13.5	40°		
	LL01XP-DGxxL06-M2	32.8x18	30° 40°		V
	LL01ED-AJxxL06	28.8x19.8	25° 40° 60°		
	LL01ED-AKxxL06	34.6x18.7	25° 40°		
	LL01ED-ASxxR06	19.9x10.6	38°		
	LL01ED-ASxxL06	19.9x10.6	60°		
	LL01ED-BBxxL06	35.7x15.9	60°		
	LL01ED-CTxxL06	31x11.2	38°		
	LL01ED-FMxxL06	19.9x10.6	38°		
	LL01NI-GRxxL06	19.4x13.5	40° 60°		
	LL01OS-AXxxL02	19.7x11.5	40°		
	LL01OS-BWxxL06	37.2x15.4	30°		
	LL01OS-BYxxL06	37.2x15.4	30°		
	LL01OS-CBxxL06	25.6x10	15°		
	LL01ZZ-EXxxL06-M2	22.4x9.7	25° 40° 60°		V
LL01XP-FLxxL06-M2	24.3x11.5	25° 40° 60°		V	
3 in 1	LL03ED-GKxxL06	33.2x10.3	40°		
	LL03LU-DMxxL06	23.1x10.9		25° 40°	
	LL03LU-DOxxL06	35x10.5		25°	
4 in 1	LL04ED-GKxxL06	37x10.3	40°		
	LL04LU-DNxxL06	25.4x10.4		25°	
	LL04LU-DOxxL06	35x10.4		25°	
6 in 1	LL06CR-AXNxxL06-M2	76 x 13		25°	V
	LL06ED-ADxxL06	73.3x13.9	60°		
	LL06CR-AXMxxL06-M2	76 x 13		15° 25°	V
	LL06CR-AXLxxL06-M2	76 x 13		25°	V

Type	Part Number	DxH(mm)	Full Angle	FWHM	Holder
7 in 1	LL07ED-GKxxL06	47x10.7	40°		
	LL07ZZ-FUxxL06	50.3x10.8		25°	
	LL007ZZ-FVxxL06	39.1x10.6		25°	
9 in 1	LL09ED-ACxxL06	95x12.8	25°		
	LL09ED-ATxxL06	90.6x16.5	40°		
	LL09ED-GKxxL06	67x9.8	40°		
12 in 1	LL12ED-AGxxL06	122x13.5	45°		
	LL12ED-GKxxL06	67.8x10.8	40°		
15 in 1	LL15ED-BHxxL06	95x11.1	40°		
24 in 1	LL24ED-ABxxL06	174.5x12.5	45°		
36 in 1	LL36ED-AAxxL06	140x12.7	45°		



Z 5





Ceramic
3535



■ Ceramic 3535

Type	Part Number	DxH(mm)	Full Angle	FWHM	Holder	Type	Part Number	DxH(mm)	Full Angle	FWHM	Holder	
Single	LL01CR-DFxxL06	11.8 x 6.65	100°			7 in 1	LL07ZZ-FUxxL06	50.35 x 10.7		25°		
	LL01CR-DGxxL06	28.8 x 16.75	20° 30° 40° 50° 60°				LL07ZZ-FVxxL06	39.2 x 10.8		30° 60°	15° 25°	
	LL01CR-HQxxL06	14.8 x 9.5	60° 80°			9 in 1	LL09CR-RXxxL06	70 x 10.3		40° 60°		
	LL01CR-NExxL06	19.4 x 15	25° 40° 60° 80°				LL09ED-UYxxL06	67 x 10.3		40°		
	LL01CR-XSxxL06	22.2 x 10.6	40°				LL09OS-GKxxL06	67 x 9.8		40° 60°		
	LL01ED-BBxxL06	35.8 x 16.5	60°				LL09ED-ATxxL06	90.6 x 17.5		40°		
	LL01ED-CTxxL06	31 x 11.2	38°			12 in 1	LL12CR-RXxxL06	70 x 10.3		40° 60°		
	LL01LU-AFCxxL06	19.4 x 11.8	20°x50°				LL12ED-AGxxL06	112 x 13.4		45°		
	LL01CR-AAFxxL02	11.8x 6.65		25° 45° 60°			LL12ED-UYxxL06	67 x 10.3		40°		
	LL01OS-BWxxL06	37.2 x 15.35	30°				LL12OS-GKxxL06	67 x 9.8		40° 60°		
	LL01OS-BYxxL06	37.2x 15.35	30°			18 in 1	LL18ED-BlxxL06	110 x 13.1		40°		
	LL01OS-MQxxL06	19.45 x 13.7	25° 40° 60°			24 in 1	LL24ED-ABxxL06	174.5 x 12.7		45°		
	LL01ZZ-EXxxL06	21 x 9.3	40° 60°			Street Lighting	LL01CR-AU85135L02	18 x 10.2 x 6.1		85°x135° (Asymmetry)		
	LL01ZZ-FLxxL06	22.2 x 10.6	10° 40° 60°				LL01CR-FT60135L02	18 x 9.3 x 5.9		60°x135° (Symmetry)		
	LL01ED-FMxxL06	19.9 x 10.55	38°				LL01CR-KM6090L02	17.55 x 11.6 x 8.6		60°x90° (Symmetry)		
LL01OS-CBxxL06	25.6 x 10	15°			LL01CR-OW70130L02		17.4 x 12.75 x 7.2		70°x130° (Asymmetry)			
3 in 1	LL03CR-RXxxL06	35 x 9.6	40° 60°				LL01CR-PB70140L02	22.4 x 11.4 x 6.9		70°x140° (Asymmetry)		
	LL03ED-UYxxL06	33.2 x 10.3	40°				LL24CR-AU75135L02	120 x 100 x 10.2		75°x135° (Asymmetry)		
	LL03OS-GKxxL06	33.2 x 9.8	40° 60°				LL24ED-AU75135L02	135 x 112 x 9.6		75°x135° (Asymmetry)		
4 in 1	LL04CR-RXxxL06	35 x 9.7	40° 60°			LL30CR-PT60140L02	235 x 71 x 9.4		60°x140° (Asymmetry)			
	LL04ED-UYxxL06	37 x 10.3	40°									
	LL04OS-GKxxL06	37 x 9.8	40° 60°									
6 in 1	LL06CR-RXxxL06	50 x 9.65	40° 60°									
7 in 1	LL07CR-RXxxL06	50 x 10.3	40° 60°									
	LL07ED-UYxxL06	47 x 10.3	40°									
	LL07OS-GKxxL06	47 x 9.8	40° 60°									

▶ **Lighting source confirmation:**

LED manufacturer/ Type of LED/ LED spec/ LED sample is required
The LED position layout is needed

▶ **Optical requirements confirmation:**

Required beam angle (in full view)/ if in half view, the light intensity curve is needed
Other luminance demands, such as uniformity, certain level of lux in a specific area from a certain distance

▶ **Mechanical requirements confirmation:**

The limitation of dimensions is necessary

▶ **Installed environment/ application/ other specific requirements, such as material:**

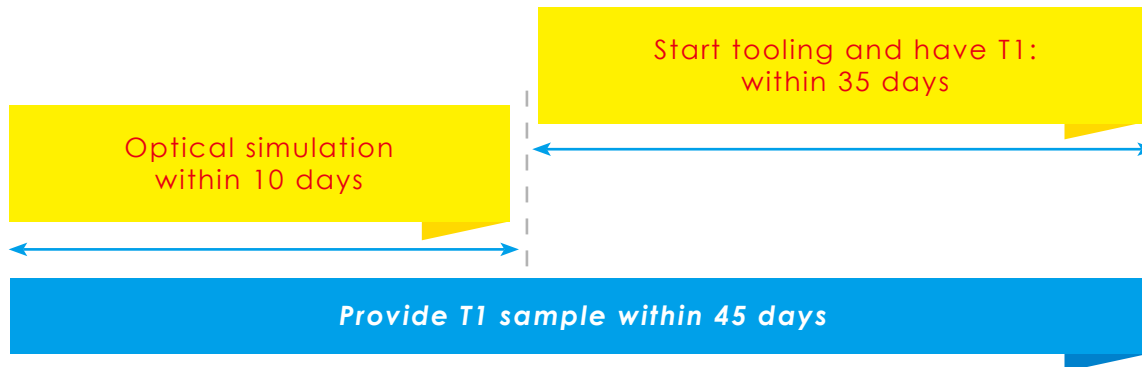



Street Lens



Color Mixing
Lens



Elliptical-Beam
Lens



Fresnel Lens



COB Lens

PRODUCT ROADMAP



Hybrid Lens



Thermal Conductive
Plastic
Semi-Module



Plastic Plating Reflector
Aluminum Stamping Reflector



Automobile
Optics



Omni-Directional
Bulb

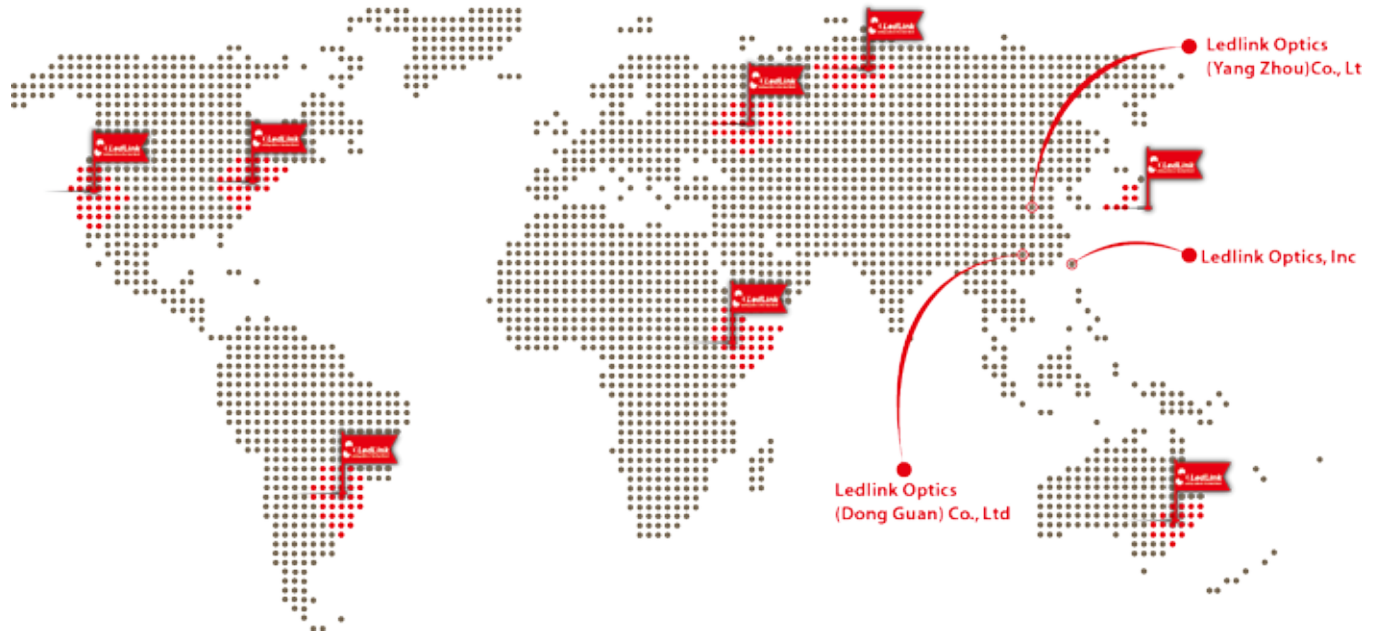

Headquater : Taiwan

15F, No.655, Bannan Rd., Chung-Ho Dist,
New Taipei City, Taiwan.
T:+886-2-8227-6126 / F:+886-2-8227-6127
service@ledlink-optics.com



Factory : Dong-Guan

No.5, TianKeng Industrial District HengLi Town,
DongGuan CityGuangDong Province China
T:+86-769-8897-7888 / F:+86-769-8897-5699
Jerry Yu:+86-138-2916-1132
E:jerry@ledlink-optics.com



Factory : Yang-Zhou

NO.180, Linjiang Road, Yangzhou City,
Jiangsu Province, China
Benson Chou:+86-186-6519-6583
E:benson_chou@ledlink-optics.com

Компания «Life Electronics» занимается поставками электронных компонентов импортного и отечественного производства от производителей и со складов крупных дистрибьюторов Европы, Америки и Азии.

С конца 2013 года компания активно расширяет линейку поставок компонентов по направлению коаксиальный кабель, кварцевые генераторы и конденсаторы (керамические, пленочные, электролитические), за счёт заключения дистрибьюторских договоров

Мы предлагаем:

- Конкурентоспособные цены и скидки постоянным клиентам.
- Специальные условия для постоянных клиентов.
- Подбор аналогов.
- Поставку компонентов в любых объемах, удовлетворяющих вашим потребностям.
- Приемлемые сроки поставки, возможна ускоренная поставка.
- Доставку товара в любую точку России и стран СНГ.
- Комплексную поставку.
- Работу по проектам и поставку образцов.
- Формирование склада под заказчика.
- Сертификаты соответствия на поставляемую продукцию (по желанию клиента).
- Тестирование поставляемой продукции.
- Поставку компонентов, требующих военную и космическую приемку.
- Входной контроль качества.
- Наличие сертификата ISO.

В составе нашей компании организован Конструкторский отдел, призванный помогать разработчикам, и инженерам.

Конструкторский отдел помогает осуществить:

- Регистрацию проекта у производителя компонентов.
- Техническую поддержку проекта.
- Защиту от снятия компонента с производства.
- Оценку стоимости проекта по компонентам.
- Изготовление тестовой платы монтаж и пусконаладочные работы.



Тел: +7 (812) 336 43 04 (многоканальный)

Email: org@lifeelectronics.ru