

---

## 12A High-Speed MOSFET Drivers

---

### Features

- High Peak Output Current: 13A (typical)
- Low Shoot-Through/Cross-Conduction Current in Output Stage
- Wide Input Supply Voltage Operating Range:
  - 4.5V to 18V
- High Continuous Output Current: 2.6A (max.)
- Matched Fast Rise and Fall Times:
  - 21 ns with 10,000 pF Load
  - 42 ns with 22,000 pF Load
- Matched Short Propagation Delays: 44 ns (typ.)
- Low Supply Current:
  - With Logic '1' Input – 140  $\mu$ A (typical)
  - With Logic '0' Input – 40  $\mu$ A (typical)
- Low Output Impedance: 0.9 $\Omega$  (typical)
- Latch-Up Protected: Will Withstand 1.5A Output Reverse Current
- Input Will Withstand Negative Inputs Up To 5V
- Pin-Compatible with the TC4420/TC4429, TC4421/TC4422 and TC4421A/TC4422A MOSFET Drivers
- Space-Saving, Thermally-Enhanced, 8-Pin DFN Package

### Applications

- Line Drivers for Extra Heavily-Loaded Lines
- Pulse Generators
- Driving the Largest MOSFETs and IGBTs
- Local Power ON/OFF Switch
- Motor and Solenoid Driver
- LF Initiator

### General Description

The TC4451/TC4452 are single-output MOSFET drivers. These devices are high-current buffer/drivers capable of driving large MOSFETs and Insulated Gate Bipolar Transistors (IGBTs). The TC4451/TC4452 have matched output rise and fall times, as well as matched leading and falling-edge propagation delay times. The TC4451/TC4452 devices also have very low cross-conduction current, reducing the overall power dissipation of the device.

These devices are essentially immune to any form of upset, except direct overvoltage or over-dissipation. They cannot be latched under any conditions within their power and voltage ratings. These parts are not subject to damage or improper operation when up to 5V of ground bounce is present on their ground terminals. They can accept, without damage or logic upset, more than 1.5A inductive current of either polarity being forced back into their outputs. In addition, all terminals are fully protected against up to 4 kV of electrostatic discharge.

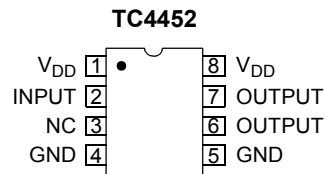
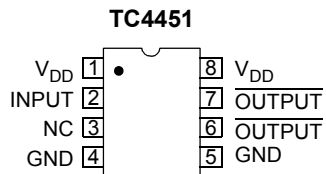
The TC4451/TC4452 inputs may be driven directly from either TTL or CMOS (3V to 18V). In addition, 300 mV of hysteresis is built into the input, providing noise immunity and allowing the device to be driven from slowly rising or falling waveforms.

With both surface-mount and pin-through-hole packages, in addition to a wide operating temperature range, the TC4451/TC4452 family of 12A MOSFET drivers fit into most any application where high gate/line capacitance drive is required.

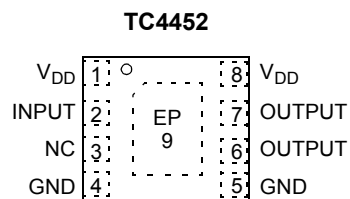
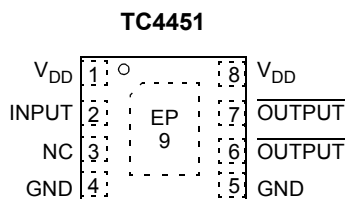
# TC4451/TC4452

## Package Types

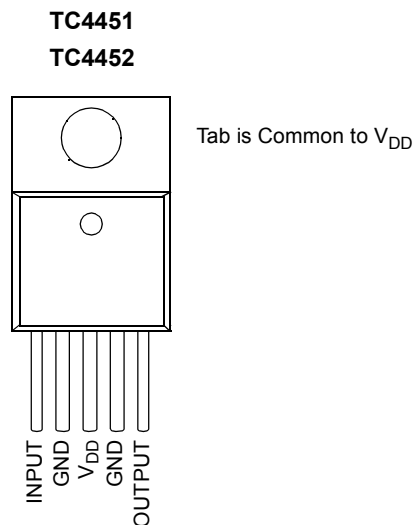
### 8-Pin PDIP/SOIC<sup>(1, 2)</sup>



### 8-Pin DFN<sup>(1, 2)</sup>



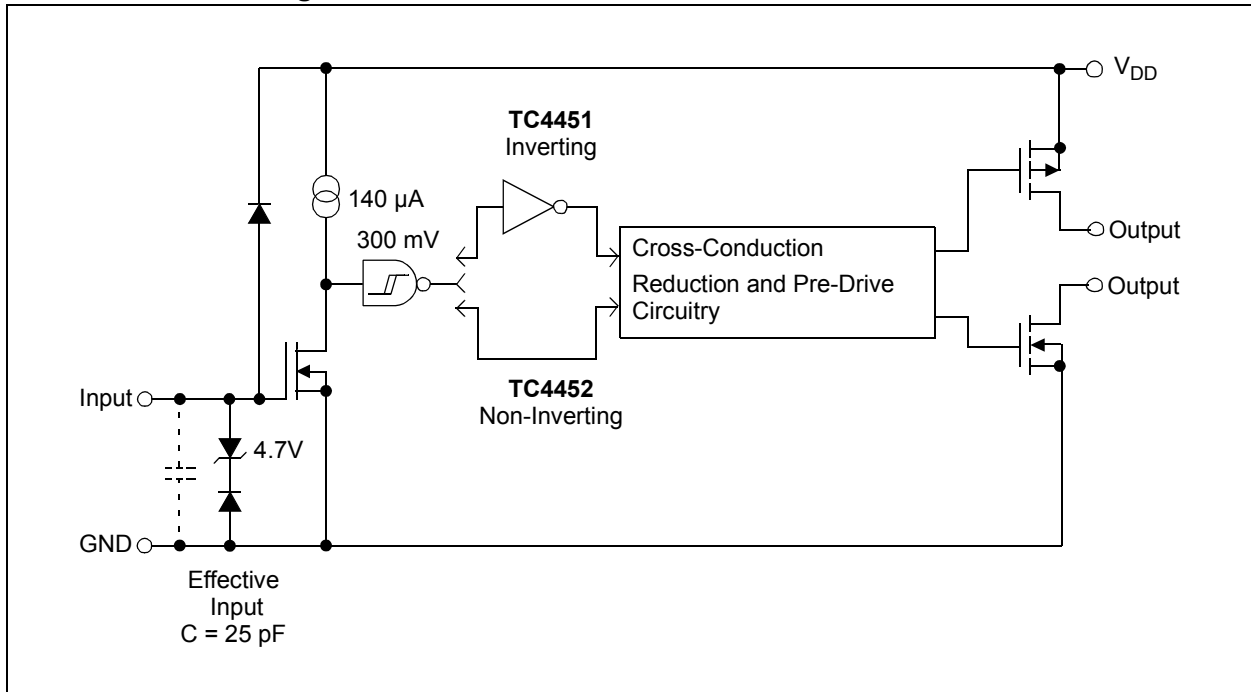
### 5-Pin TO-220<sup>(1, 2)</sup>



**Note 1:** Duplicate pins must both be connected for proper operation.

**2:** Exposed Thermal Pad (EP) of the DFN package is electrically isolated; see [Table 3-1](#).

## Functional Block Diagram



# TC4451/TC4452

## 1.0 ELECTRICAL CHARACTERISTICS

### Absolute Maximum Ratings †

|   |                                   |
|---|-----------------------------------|
| Supply Voltage .....                      | +20V                              |
| Input Voltage .....                       | ( $V_{DD} + 0.3V$ ) to (GND – 5V) |
| Input Current ( $V_{IN} > V_{DD}$ ) ..... | 50 mA                             |

† **Notice:** Stresses above those listed under “Absolute Maximum Ratings” may cause permanent damage to the device. These are stress ratings only and functional operation of the device at these or any other conditions above those indicated in the operation sections of the specifications is not implied. Exposure to Absolute Maximum Rating conditions for extended periods may affect device reliability.

### DC CHARACTERISTICS

| Electrical Specifications: Unless otherwise noted, $T_A = +25^\circ\text{C}$ with $4.5V \leq V_{DD} \leq 18V$ . |           |                  |      |                |               |   |
|---|-----------|------------------|------|----------------|---------------|---|
| Parameters  | Sym       | Min              | Typ  | Max            | Units         | Conditions  |
| <b>Input</b>  |           |                  |      |                |               |   |
| Logic ‘1’, High Input Voltage   | $V_{IH}$  | 2.4              | 1.5  | —              | V             |   |
| Logic ‘0’, Low Input Voltage  | $V_{IL}$  | —                | 1.3  | 0.8            | V             |   |
| Input Current   | $I_{IN}$  | –10              | —    | +10            | $\mu\text{A}$ | $0V \leq V_{IN} \leq V_{DD}$                      |
| Input Voltage   | $V_{IN}$  | –5               | —    | $V_{DD} + 0.3$ | V             |   |
| <b>Output</b>   |           |                  |      |                |               |   |
| High Output Voltage   | $V_{OH}$  | $V_{DD} - 0.025$ | —    | —              | V             | DC Test   |
| Low Output Voltage  | $V_{OL}$  | —                | —    | 0.025          | V             | DC Test   |
| Output Resistance, High   | $R_{OH}$  | —                | 1.0  | 1.5            | $\Omega$      | $I_{OUT} = 10\text{ mA}$ , $V_{DD} = 18V$         |
| Output Resistance, Low  | $R_{OL}$  | —                | 0.9  | 1.5            | $\Omega$      | $I_{OUT} = 10\text{ mA}$ , $V_{DD} = 18V$         |
| Peak Output Current   | $I_{PK}$  | —                | 13   | —              | A             | $V_{DD} = 18V$                                    |
| Continuous Output Current   | $I_{DC}$  | 2.6              | —    | —              | A             | $10V \leq V_{DD} \leq 18V$ (Note 2, Note 3)       |
| Latch-Up Protection Withstand Reverse Current   | $I_{REV}$ | —                | >1.5 | —              | A             | Duty cycle $\leq 2\%$ , $t \leq 300\ \mu\text{s}$ |
| <b>Switching Time (Note 1)</b>  |           |                  |      |                |               |   |
| Rise Time   | $t_R$     | —                | 30   | 40             | ns            | Figure 4-1, $C_L = 15,000\text{ pF}$              |
| Fall Time   | $t_F$     | —                | 32   | 40             | ns            | Figure 4-1, $C_L = 15,000\text{ pF}$              |
| Propagation Delay Time  | $t_{D1}$  | —                | 44   | 52             | ns            | Figure 4-1, $C_L = 15,000\text{ pF}$              |
| Propagation Delay Time  | $t_{D2}$  | —                | 44   | 52             | ns            | Figure 4-1, $C_L = 15,000\text{ pF}$              |
| <b>Power Supply</b>   |           |                  |      |                |               |   |
| Power Supply Current  | $I_S$     | —                | 140  | 200            | $\mu\text{A}$ | $V_{IN} = 3V$                                     |
|   |           | —                | 40   | 100            | $\mu\text{A}$ | $V_{IN} = 0V$                                     |
| Operating Input Voltage   | $V_{DD}$  | 4.5              | —    | 18.0           | V             |   |
| $V_{DD}$ Ramp Rate  | $SV_{DD}$ | 0.2              | —    | —              | V/ms          |   |

- Note 1:** Switching times ensured by design.  
**Note 2:** Tested during characterization, not production tested.  
**Note 3:** Valid for AT and MF packages only.  $T_A = +25^\circ\text{C}$ .

## DC CHARACTERISTICS (OVER OPERATING TEMPERATURE RANGE)

| Electrical Specifications: Unless otherwise noted, over operating temperature range with $4.5V \leq V_{DD} \leq 18V$ . |           |                  |     |       |          |  |
|--|-----------|------------------|-----|-------|----------|--|
| Parameters   | Sym       | Min              | Typ | Max   | Units    | Conditions                                 |
| <b>Input</b>   |           |                  |     |       |          |  |
| Logic '1', High Input Voltage  | $V_{IH}$  | 2.4              | —   | —     | V        |  |
| Logic '0', Low Input Voltage   | $V_{IL}$  | —                | —   | 0.8   | V        |  |
| Input Current  | $I_{IN}$  | -10              | —   | +10   | $\mu A$  | $0V \leq V_{IN} \leq V_{DD}$               |
| <b>Output</b>  |           |                  |     |       |          |  |
| High Output Voltage  | $V_{OH}$  | $V_{DD} - 0.025$ | —   | —     | V        | DC Test                                    |
| Low Output Voltage   | $V_{OL}$  | —                | —   | 0.025 | V        | DC Test                                    |
| Output Resistance, High  | $R_{OH}$  | —                | —   | 2.2   | $\Omega$ | $I_{OUT} = 10 \text{ mA}$ , $V_{DD} = 18V$ |
| Output Resistance, Low   | $R_{OL}$  | —                | —   | 2.0   | $\Omega$ | $I_{OUT} = 10 \text{ mA}$ , $V_{DD} = 18V$ |
| <b>Switching Time (Note 1)</b>   |           |                  |     |       |          |  |
| Rise Time  | $t_R$     | —                | 35  | 60    | ns       | Figure 4-1, $C_L = 15,000 \text{ pF}$      |
| Fall Time  | $t_F$     | —                | 38  | 60    | ns       | Figure 4-1, $C_L = 15,000 \text{ pF}$      |
| Propagation Delay Time   | $t_{D1}$  | —                | 55  | 65    | ns       | Figure 4-1, $C_L = 15,000 \text{ pF}$      |
| Propagation Delay Time   | $t_{D2}$  | —                | 55  | 65    | ns       | Figure 4-1, $C_L = 15,000 \text{ pF}$      |
| <b>Power Supply</b>  |           |                  |     |       |          |  |
| Power Supply Current   | $I_S$     | —                | 200 | 400   | $\mu A$  | $V_{IN} = 3V$                              |
|  |           | —                | 50  | 150   | $\mu A$  | $V_{IN} = 0V$                              |
| Operating Input Voltage  | $V_{DD}$  | 4.5              | —   | 18.0  | V        |  |
| $V_{DD}$ Ramp Rate   | $SV_{DD}$ | 0.2              | —   | —     | V/ms     |  |

**Note 1:** Switching times ensured by design.

## TEMPERATURE CHARACTERISTICS

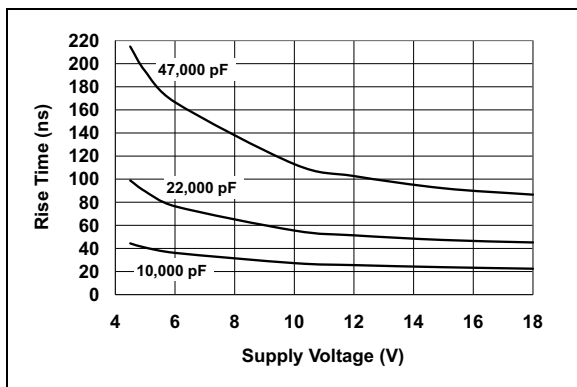
| Electrical Specifications: Unless otherwise noted, all parameters apply with $4.5V \leq V_{DD} \leq 18V$ . |               |     |       |      |               |   |
|--|---------------|-----|-------|------|---------------|---|
| Parameters   | Sym           | Min | Typ   | Max  | Units         | Conditions                                      |
| <b>Temperature Ranges</b>  |               |     |       |      |               |   |
| Specified Temperature Range (V)  | $T_A$         | -40 | —     | +125 | $^{\circ}C$   |   |
| Maximum Junction Temperature   | $T_J$         | —   | —     | +150 | $^{\circ}C$   |   |
| Storage Temperature Range  | $T_A$         | -65 | —     | +150 | $^{\circ}C$   |   |
| <b>Package Thermal Resistances</b>   |               |     |       |      |               |   |
| Thermal Resistance, 5L-TO-220  | $\theta_{JA}$ | —   | 39.5  | —    | $^{\circ}C/W$ | Without heat sink                               |
| Thermal Resistance, 8L-6x5 DFN   | $\theta_{JA}$ | —   | 35.7  | —    | $^{\circ}C/W$ | Typical 4-layer board with vias to ground plane |
| Thermal Resistance, 8L-PDIP  | $\theta_{JA}$ | —   | 89.3  | —    | $^{\circ}C/W$ |   |
| Thermal Resistance, 8L-SOIC  | $\theta_{JA}$ | —   | 149.5 | —    | $^{\circ}C/W$ |   |

# TC4451/TC4452

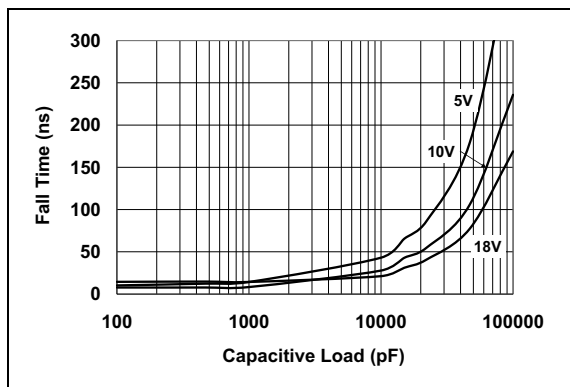
## 2.0 TYPICAL PERFORMANCE CURVES

**Note:** The graphs and tables provided following this note are a statistical summary based on a limited number of samples and are provided for informational purposes only. The performance characteristics listed herein are not tested or guaranteed. In some graphs or tables, the data presented may be outside the specified operating range (e.g., outside specified power supply range) and therefore outside the warranted range.

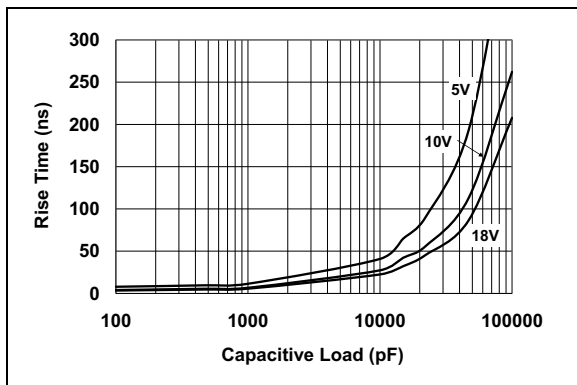
**Note:** Unless otherwise indicated,  $T_A = +25^\circ\text{C}$  with  $4.5\text{V} \leq V_{DD} \leq 18\text{V}$ .



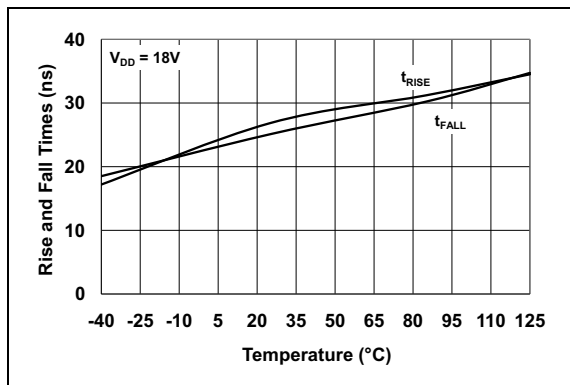
**FIGURE 2-1:** Rise Time vs. Supply Voltage.



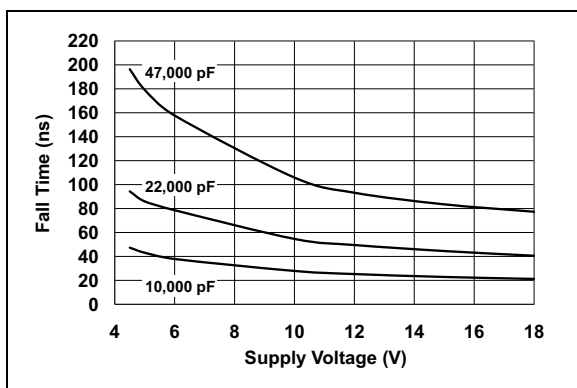
**FIGURE 2-4:** Fall Time vs. Capacitive Load.



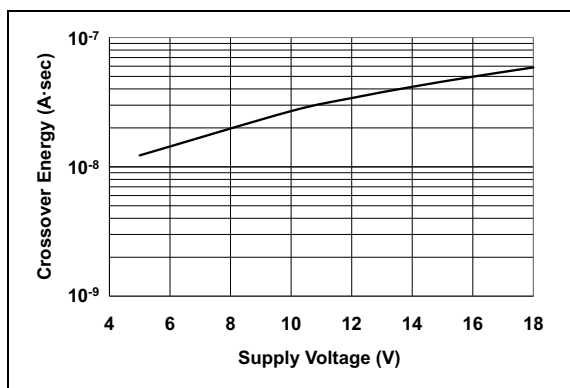
**FIGURE 2-2:** Rise Time vs. Capacitive Load.



**FIGURE 2-5:** Rise and Fall Times vs. Temperature.

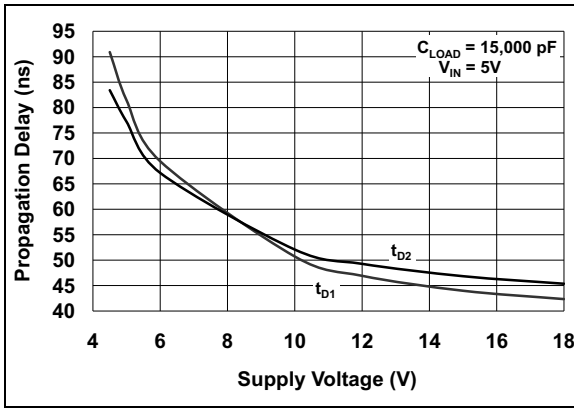


**FIGURE 2-3:** Fall Time vs. Supply Voltage.

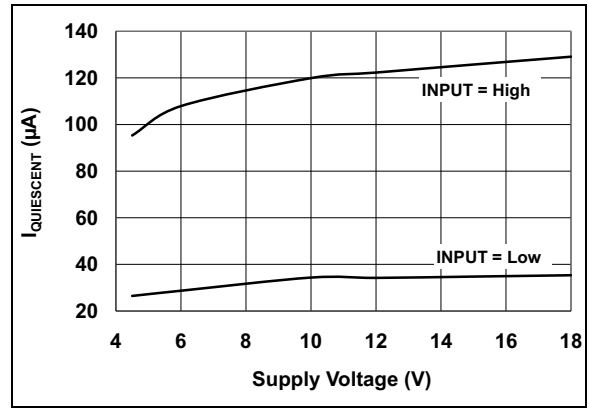


**FIGURE 2-6:** Crossover Energy vs. Supply Voltage.

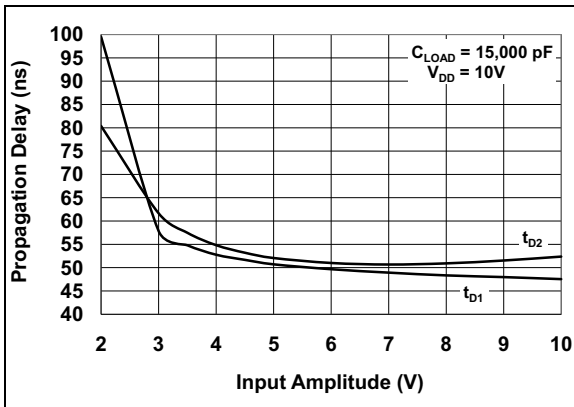
**Note:** Unless otherwise indicated,  $T_A = +25^\circ\text{C}$  with  $4.5\text{V} \leq V_{DD} \leq 18\text{V}$ .



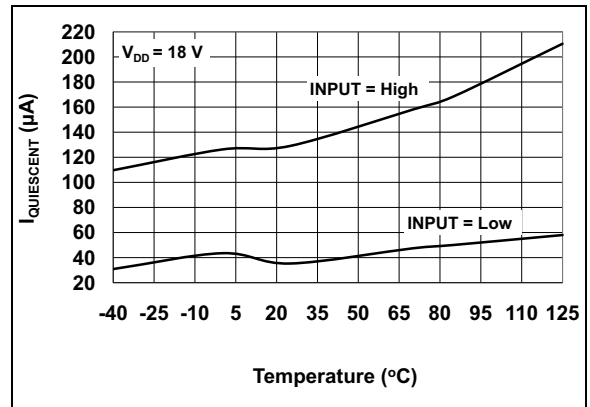
**FIGURE 2-7:** Propagation Delay vs. Supply Voltage.



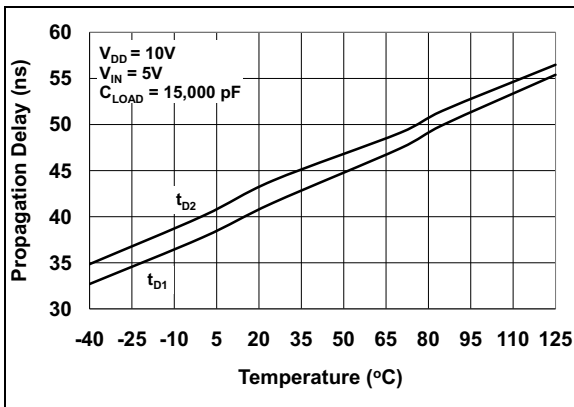
**FIGURE 2-10:** Quiescent Supply Current vs. Supply Voltage.



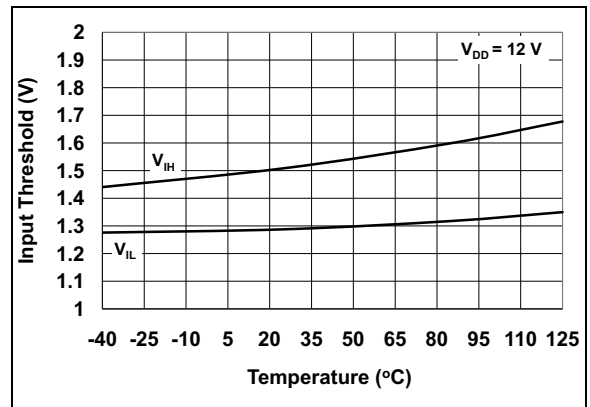
**FIGURE 2-8:** Propagation Delay vs. Input Amplitude.



**FIGURE 2-11:** Quiescent Supply Current vs. Temperature.



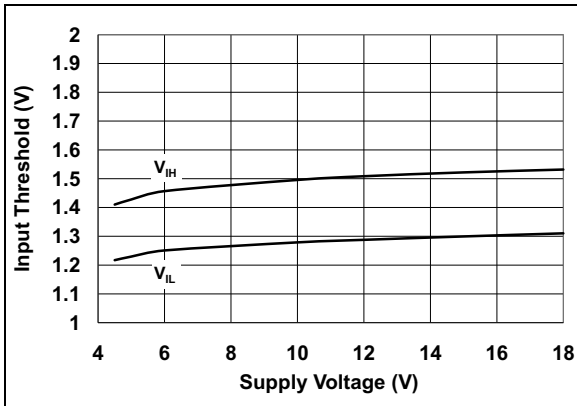
**FIGURE 2-9:** Propagation Delay vs. Temperature.



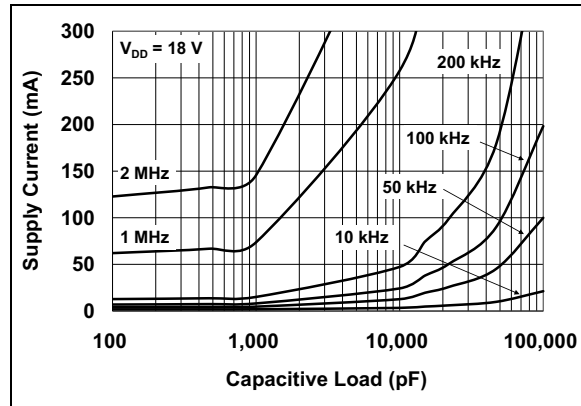
**FIGURE 2-12:** Input Threshold vs. Temperature.

# TC4451/TC4452

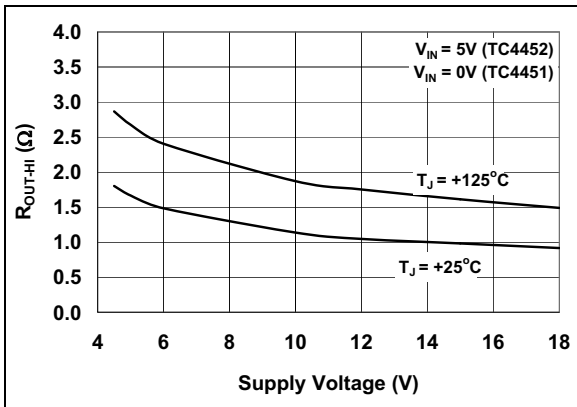
Note: Unless otherwise indicated,  $T_A = +25^\circ\text{C}$  with  $4.5\text{V} \leq V_{DD} \leq 18\text{V}$ .



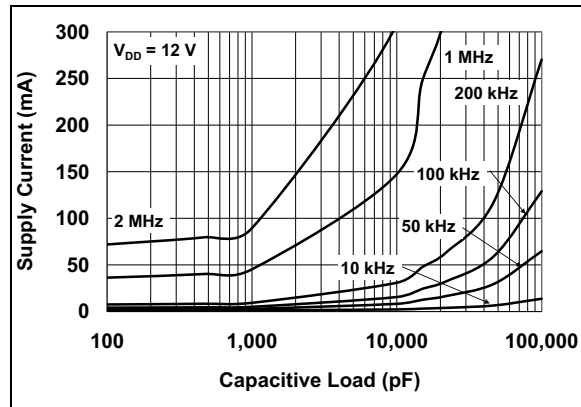
**FIGURE 2-13:** Input Threshold vs. Supply Voltage.



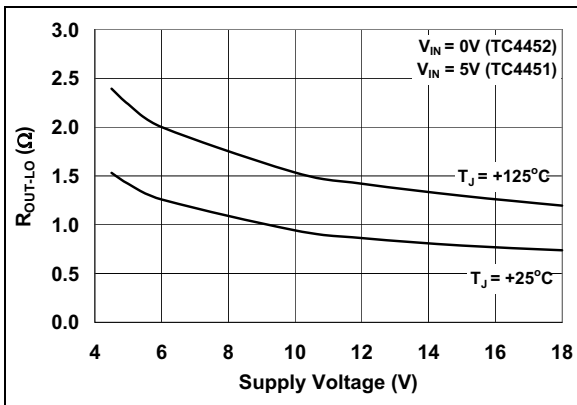
**FIGURE 2-16:** Supply Current vs. Capacitive Load ( $V_{DD} = 18\text{V}$ ).



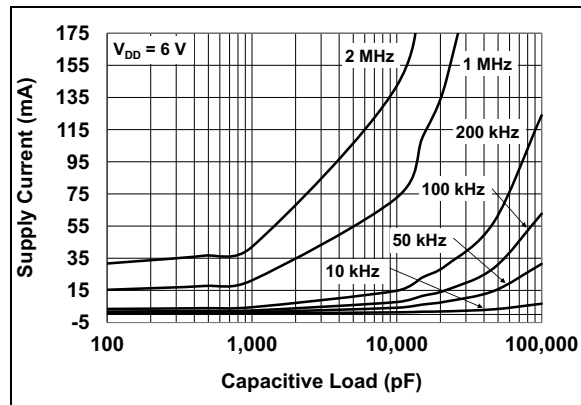
**FIGURE 2-14:** High-State Output Resistance vs. Supply Voltage.



**FIGURE 2-17:** Supply Current vs. Capacitive Load ( $V_{DD} = 12\text{V}$ ).



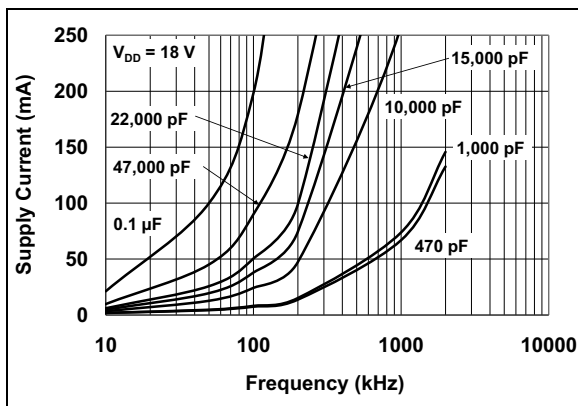
**FIGURE 2-15:** Low-State Output Resistance vs. Supply Voltage.



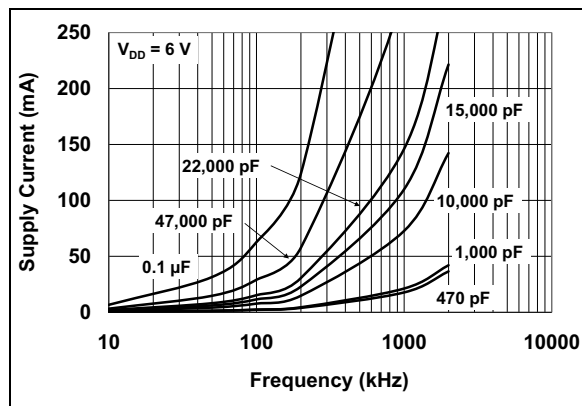
**FIGURE 2-18:** Supply Current vs. Capacitive Load ( $V_{DD} = 6\text{V}$ ).



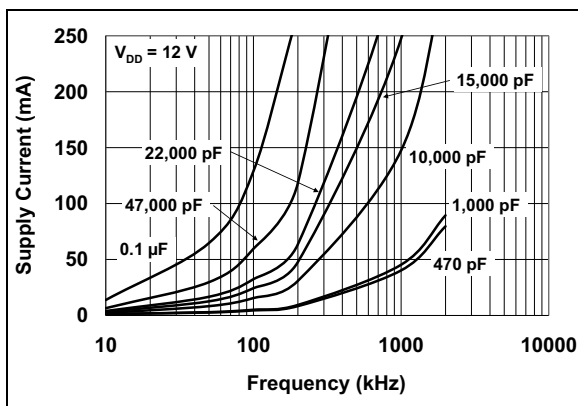
**Note:** Unless otherwise indicated,  $T_A = +25^\circ\text{C}$  with  $4.5\text{V} \leq V_{DD} \leq 18\text{V}$ .



**FIGURE 2-19:** Supply Current vs. Frequency ( $V_{DD} = 18\text{V}$ ).



**FIGURE 2-21:** Supply Current vs. Frequency ( $V_{DD} = 6\text{V}$ ).



**FIGURE 2-20:** Supply Current vs. Frequency ( $V_{DD} = 12\text{V}$ ).

# TC4451/TC4452

## 3.0 PIN DESCRIPTIONS

The descriptions of the pins are listed in [Table 3-1](#).

**TABLE 3-1: PIN FUNCTION TABLE**

| 8-Pin PDIP, SOIC | 8-Pin DFN | 5-Pin TO-220 | Symbol   | Description                              |
|------------------|-----------|--------------|----------|--|
| 1                | 1         | —            | $V_{DD}$ | Supply input, 4.5V to 18V                |
| 2                | 2         | 1            | INPUT    | Control input, TTL/CMOS-compatible input |
| 3                | 3         | —            | NC       | No connection                            |
| 4                | 4         | 2            | GND      | Ground                                   |
| 5                | 5         | 4            | GND      | Ground                                   |
| 6                | 6         | 5            | OUTPUT   | CMOS push-pull output                    |
| 7                | 7         | —            | OUTPUT   | CMOS push-pull output                    |
| 8                | 8         | 3            | $V_{DD}$ | Supply input, 4.5V to 18V                |
| —                | 9         | —            | EP       | Exposed metal pad                        |
| —                | —         | TAB          | $V_{DD}$ | Metal tab is at the $V_{DD}$ potential   |

### 3.1 Supply Input ( $V_{DD}$ )

The  $V_{DD}$  input is the bias supply for the MOSFET driver and is rated for 4.5V to 18V with respect to the ground pin. The  $V_{DD}$  input should be bypassed to ground with a local ceramic capacitor. The value of the capacitor should be chosen based on the capacitive load that is being driven. A minimum value of 1.0  $\mu$ F is suggested.

### 3.2 Control Input (INPUT)

The MOSFET driver input is a high-impedance, TTL/CMOS-compatible input. The input also has 300 mV of hysteresis between the high and low thresholds that prevents output glitching even when the rise and fall time of the input signal is very slow.

### 3.3 CMOS Push-Pull Output (OUTPUT)

The MOSFET driver output is a low-impedance, CMOS, push-pull style output capable of driving a capacitive load with 12A peak currents. The MOSFET driver output is capable of withstanding 1.5A peak reverse currents of either polarity.

### 3.4 Ground (GND)

The ground pins are the return path for the bias current and for the high peak currents that discharge the load capacitor. The ground pins should be tied into a ground plane or have very short traces to the bias supply source return.

### 3.5 Exposed Metal Pad (EP)

The exposed metal pad of the 6x5 DFN package is not internally connected to any potential. Therefore, this pad can be connected to a ground plane or other copper plane on a Printed Circuit Board (PCB) to aid in heat removal from the package.

### 3.6 Metal Tab

The metal tab of the TO-220 package is connected to the  $V_{DD}$  potential of the device. This connection to  $V_{DD}$  can be used as a current carrying path for the device.

## 4.0 APPLICATIONS INFORMATION



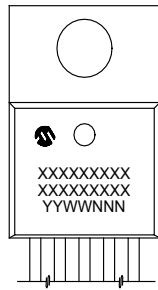
**FIGURE 4-1:** Switching Time Test Circuits.

# TC4451/TC4452

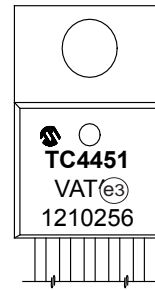
## 5.0 PACKAGING INFORMATION

### 5.1 Package Marking Information

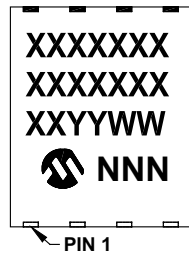
5-Lead TO-220



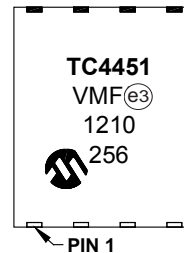
Example:



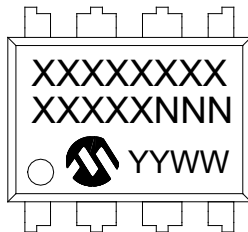
8-Lead DFN-S (6x5x0.9 mm)



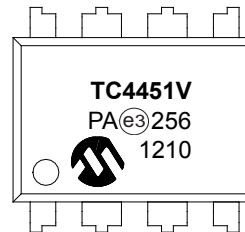
Example:



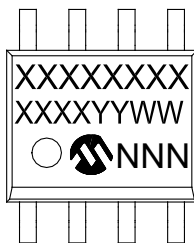
8-Lead PDIP (300 mil)



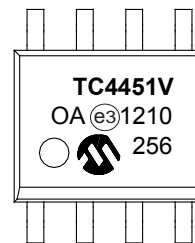
Example



8-Lead SOIC (3.90 mm)



Example



|                |        |  |
|----------------|--------|--|
| <b>Legend:</b> | XX...X | Customer-specific information  |
|                | Y      | Year code (last digit of calendar year)  |
|                | YY     | Year code (last 2 digits of calendar year)   |
|                | WW     | Week code (week of January 1 is week '01')   |
|                | NNN    | Alphanumeric traceability code   |
|                | (e3)   | Pb-free JEDEC designator for Matte Tin (Sn)  |
|                | *      | This package is Pb-free. The Pb-free JEDEC designator (e3) can be found on the outer packaging for this package. |

**Note:** In the event the full Microchip part number cannot be marked on one line, it will be carried over to the next line, thus limiting the number of available characters for customer-specific information.

## 5-Lead Plastic Transistor Outline (AT) [TO-220]

**Note:** For the most current package drawings, please see the Microchip Packaging Specification located at <http://www.microchip.com/packaging>



| Dimension Limits       | Units | INCHES   |      |      |
|------------------------|-------|----------|------|------|
|                        |       | MIN      | NOM  | MAX  |
| Number of Pins         | N     | 5        |      |      |
| Pitch                  | e     | .067 BSC |      |      |
| Overall Pin Pitch      | e1    | .268 BSC |      |      |
| Overall Height         | A     | .140     | –    | .190 |
| Overall Width          | E     | .380     | –    | .420 |
| Overall Length         | D     | .560     | –    | .650 |
| Molded Package Length  | D1    | .330     | –    | .355 |
| Tab Length             | H1    | .204     | –    | .293 |
| Tab Thickness          | A1    | .020     | –    | .055 |
| Mounting Hole Center   | Q     | .100     | –    | .120 |
| Mounting Hole Diameter | φP    | .139     | –    | .156 |
| Lead Length            | L     | .482     | –    | .590 |
| Base to Bottom of Lead | A2    | .080     | –    | .115 |
| Lead Thickness         | c     | .012     | –    | .025 |
| Lead Width             | b     | .015     | .027 | .040 |

**Notes:**

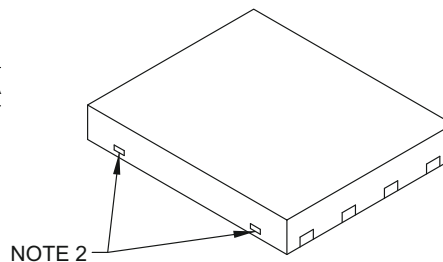
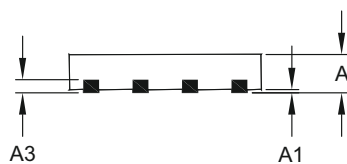
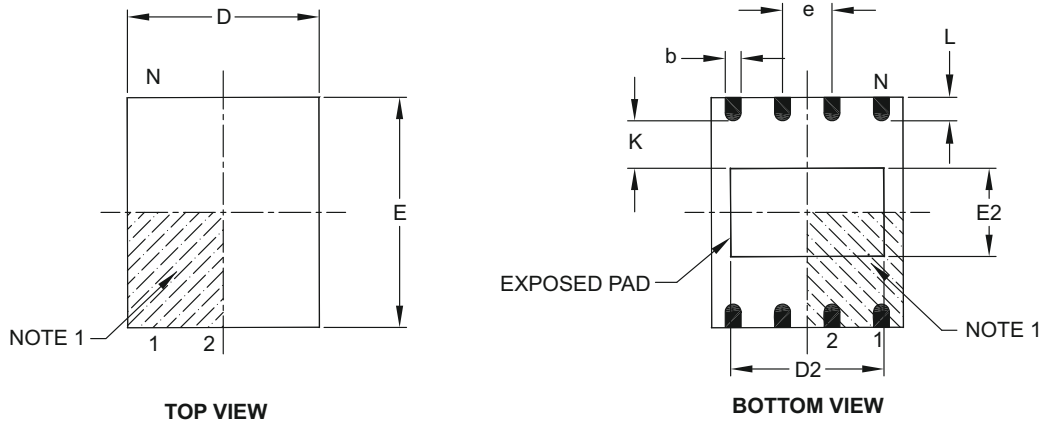
- Dimensions D and E do not include mold flash or protrusions. Mold flash or protrusions shall not exceed .005" per side.
- Dimensioning and tolerancing per ASME Y14.5M.  
BSC: Basic Dimension. Theoretically exact value shown without tolerances.

Microchip Technology Drawing C04-036B

# TC4451/TC4452

## 8-Lead Plastic Dual Flat, No Lead Package (MF) – 6x5 mm Body [DFN-S]

**Note:** For the most current package drawings, please see the Microchip Packaging Specification located at <http://www.microchip.com/packaging>



| Dimension Limits       | Units | MILLIMETERS |      |      |
|------------------------|-------|-------------|------|------|
|                        |       | MIN         | NOM  | MAX  |
| Number of Pins         | N     | 8           |      |      |
| Pitch                  | e     | 1.27 BSC    |      |      |
| Overall Height         | A     | 0.80        | 0.85 | 1.00 |
| Standoff               | A1    | 0.00        | 0.01 | 0.05 |
| Contact Thickness      | A3    | 0.20 REF    |      |      |
| Overall Length         | D     | 5.00 BSC    |      |      |
| Overall Width          | E     | 6.00 BSC    |      |      |
| Exposed Pad Length     | D2    | 3.90        | 4.00 | 4.10 |
| Exposed Pad Width      | E2    | 2.20        | 2.30 | 2.40 |
| Contact Width          | b     | 0.35        | 0.40 | 0.48 |
| Contact Length         | L     | 0.50        | 0.60 | 0.75 |
| Contact-to-Exposed Pad | K     | 0.20        | -    | -    |

**Notes:**

- Pin 1 visual index feature may vary, but must be located within the hatched area.
- Package may have one or more exposed tie bars at ends.
- Package is saw singulated.
- Dimensioning and tolerancing per ASME Y14.5M.

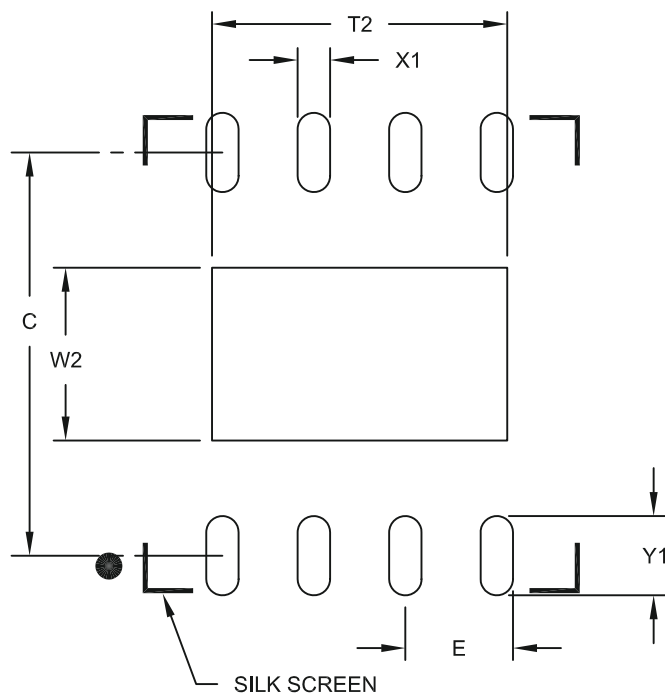
BSC: Basic Dimension. Theoretically exact value shown without tolerances.

REF: Reference Dimension, usually without tolerance, for information purposes only.

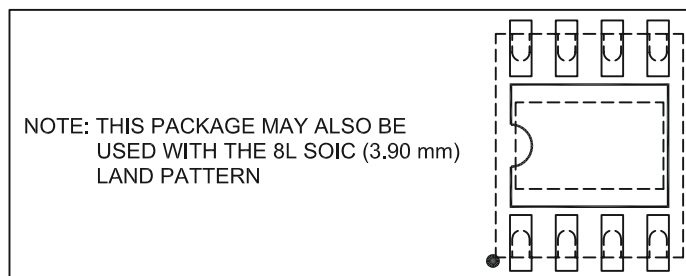
Microchip Technology Drawing C04-122B

## 8-Lead Plastic Dual Flat, No Lead Package (MF) - 6x5 mm Body [DFN-S]

**Note:** For the most current package drawings, please see the Microchip Packaging Specification located at <http://www.microchip.com/packaging>



RECOMMENDED LAND PATTERN



| Dimension Limits           | Units | MILLIMETERS |     |      |
|----------------------------|-------|-------------|-----|------|
|                            |       | MIN         | NOM | MAX  |
| Contact Pitch              | E     | 1.27 BSC    |     |      |
| Optional Center Pad Width  | W2    |             |     | 2.40 |
| Optional Center Pad Length | T2    |             |     | 4.10 |
| Contact Pad Spacing        | C     | 5.60        |     |      |
| Contact Pad Width (X8)     | X1    |             |     | 0.45 |
| Contact Pad Length (X8)    | Y1    |             |     | 1.10 |

**Notes:**

1. Dimensioning and tolerancing per ASME Y14.5M

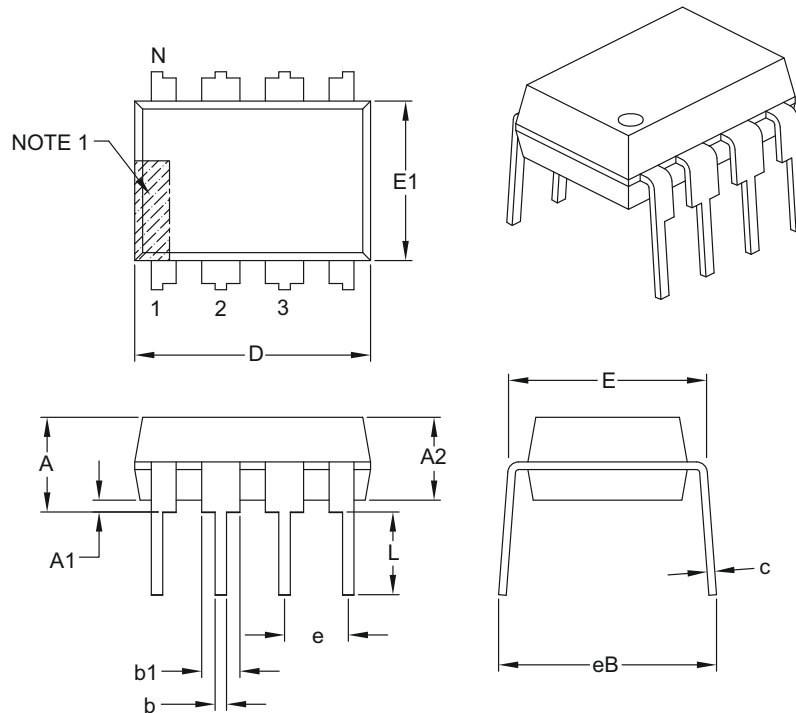
BSC: Basic Dimension. Theoretically exact value shown without tolerances.

Microchip Technology Drawing No. C04-2122A

# TC4451/TC4452

## 8-Lead Plastic Dual In-Line (PA) – 300 mil Body [PDIP]

**Note:** For the most current package drawings, please see the Microchip Packaging Specification located at <http://www.microchip.com/packaging>



| Dimension Limits           | Units | INCHES   |      |      |
|----------------------------|-------|----------|------|------|
|                            |       | MIN      | NOM  | MAX  |
| Number of Pins             | N     | 8        |      |      |
| Pitch                      | e     | .100 BSC |      |      |
| Top to Seating Plane       | A     | –        | –    | .210 |
| Molded Package Thickness   | A2    | .115     | .130 | .195 |
| Base to Seating Plane      | A1    | .015     | –    | –    |
| Shoulder to Shoulder Width | E     | .290     | .310 | .325 |
| Molded Package Width       | E1    | .240     | .250 | .280 |
| Overall Length             | D     | .348     | .365 | .400 |
| Tip to Seating Plane       | L     | .115     | .130 | .150 |
| Lead Thickness             | c     | .008     | .010 | .015 |
| Upper Lead Width           | b1    | .040     | .060 | .070 |
| Lower Lead Width           | b     | .014     | .018 | .022 |
| Overall Row Spacing §      | eB    | –        | –    | .430 |

**Notes:**

- Pin 1 visual index feature may vary, but must be located with the hatched area.
- § Significant Characteristic.
- Dimensions D and E1 do not include mold flash or protrusions. Mold flash or protrusions shall not exceed .010" per side.
- Dimensioning and tolerancing per ASME Y14.5M.

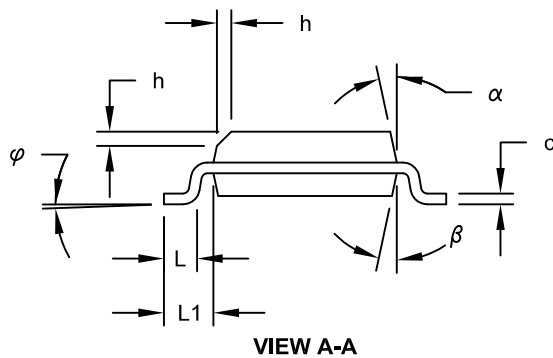
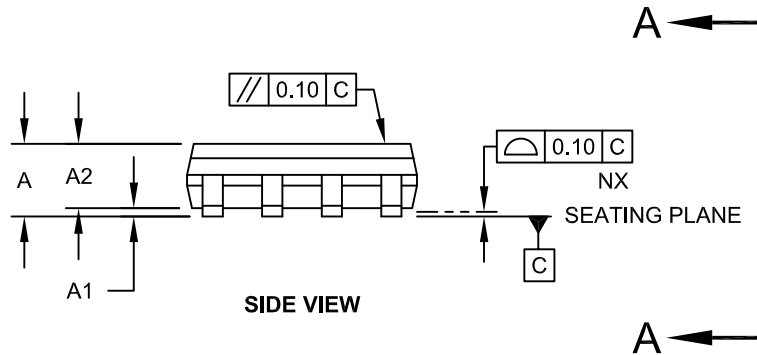
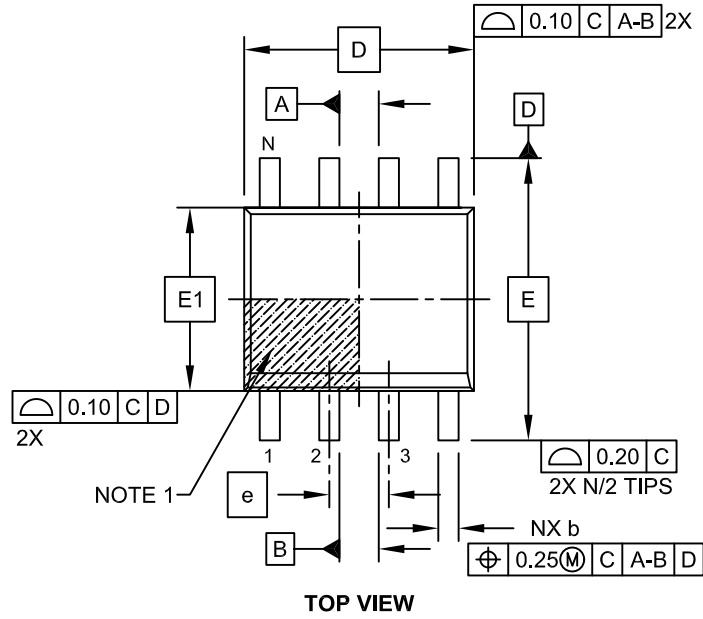
BSC: Basic Dimension. Theoretically exact value shown without tolerances.

Microchip Technology Drawing C04-018B



## 8-Lead Plastic Small Outline (OA) - Narrow, 3.90 mm Body [SOIC]

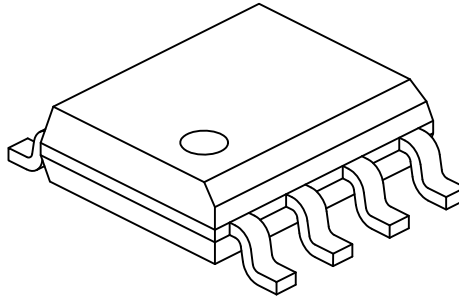
**Note:** For the most current package drawings, please see the Microchip Packaging Specification located at <http://www.microchip.com/packaging>



# TC4451/TC4452

## 8-Lead Plastic Small Outline (OA) - Narrow, 3.90 mm Body [SOIC]

**Note:** For the most current package drawings, please see the Microchip Packaging Specification located at <http://www.microchip.com/packaging>



|                          |           | Units | MILLIMETERS |     |      |
|--------------------------|-----------|-------|-------------|-----|------|
| Dimension Limits         |           |       | MIN         | NOM | MAX  |
| Number of Pins           | N         |       | 8           |     |      |
| Pitch                    | e         |       | 1.27 BSC    |     |      |
| Overall Height           | A         |       | -           | -   | 1.75 |
| Molded Package Thickness | A2        |       | 1.25        | -   | -    |
| Standoff §               | A1        |       | 0.10        | -   | 0.25 |
| Overall Width            | E         |       | 6.00 BSC    |     |      |
| Molded Package Width     | E1        |       | 3.90 BSC    |     |      |
| Overall Length           | D         |       | 4.90 BSC    |     |      |
| Chamfer (Optional)       | h         |       | 0.25        | -   | 0.50 |
| Foot Length              | L         |       | 0.40        | -   | 1.27 |
| Footprint                | L1        |       | 1.04 REF    |     |      |
| Foot Angle               | $\varphi$ |       | 0°          | -   | 8°   |
| Lead Thickness           | c         |       | 0.17        | -   | 0.25 |
| Lead Width               | b         |       | 0.31        | -   | 0.51 |
| Mold Draft Angle Top     | $\alpha$  |       | 5°          | -   | 15°  |
| Mold Draft Angle Bottom  | $\beta$   |       | 5°          | -   | 15°  |

### Notes:

1. Pin 1 visual index feature may vary, but must be located within the hatched area.
2. § Significant Characteristic
3. Dimensions D and E1 do not include mold flash or protrusions. Mold flash or protrusions shall not exceed 0.15mm per side.
4. Dimensioning and tolerancing per ASME Y14.5M

BSC: Basic Dimension. Theoretically exact value shown without tolerances.

REF: Reference Dimension, usually without tolerance, for information purposes only.

Microchip Technology Drawing No. C04-057C Sheet 2 of 2

## 8-Lead Plastic Small Outline (OA) – Narrow, 3.90 mm Body [SOIC]

**Note:** For the most current package drawings, please see the Microchip Packaging Specification located at <http://www.microchip.com/packaging>



RECOMMENDED LAND PATTERN

| Dimension Limits        | Units | MILLIMETERS |      |      |
|-------------------------|-------|-------------|------|------|
|                         |       | MIN         | NOM  | MAX  |
| Contact Pitch           | E     | 1.27 BSC    |      |      |
| Contact Pad Spacing     | C     |             | 5.40 |      |
| Contact Pad Width (X8)  | X1    |             |      | 0.60 |
| Contact Pad Length (X8) | Y1    |             |      | 1.55 |

Notes:

1. Dimensioning and tolerancing per ASME Y14.5M

BSC: Basic Dimension. Theoretically exact value shown without tolerances.

Microchip Technology Drawing No. C04-2057A

# TC4451/TC4452

---

NOTES:

## APPENDIX A: REVISION HISTORY

### Revision B (March 2012)

The following is the list of modifications:

1. Added  $V_{DD}$  Ramp Rate value in both [DC Characteristics](#) and [DC Characteristics \(Over Operating Temperature Range\)](#) tables.
2. Updated package thermal resistances values in [Temperature Characteristics](#) table.
3. Updated package specification drawings in [Section 5.0, Packaging Information](#) to show all available drawings.

### Revision A (February 2006)

Original release of this document.

# TC4451/TC4452

---

NOTES:

## PRODUCT IDENTIFICATION SYSTEM

To order or obtain information, e.g., on pricing or delivery, refer to the factory or the listed sales office.

| <u>PART NO.</u>    | <u>X</u>                 | <u>XX</u>  | <u>XXX</u>             | <b>Examples:</b>  |
|--------------------|--------------------------|--|------------------------|---|
| <b>Device</b>      | <b>Temperature Range</b> | <b>Package</b>   | <b>Tape &amp; Reel</b> |   |
| Device:            |                          | TC4451: 12A High-Speed MOSFET Driver, Inverting<br>TC4452: 12A High-Speed MOSFET Driver, Non-Inverting   |                        | a) TC4451VAT: 12A High-Speed Inverting MOSFET Driver, TO-220 package<br>b) TC4451VOA: 12A High-Speed Inverting MOSFET Driver, SOIC package<br>c) TC4451VMF: 12A High-Speed Inverting MOSFET Driver, DFN package           |
| Temperature Range: | V                        | = -40°C to +125°C  |                        | a) TC4452VPA: 12A High-Speed Non-Inverting MOSFET Driver, PDIP package<br>b) TC4452VOA: 12A High-Speed Non-Inverting MOSFET Driver, SOIC package<br>c) TC4452VMF: 12A High-Speed Non-Inverting MOSFET Driver, DFN package |
| Package: *         |                          | AT = TO-220, 5-lead<br>MF = Dual, Flat, No-Lead (6x5 mm Body), 8-lead<br>MF713 = Dual, Flat, No-Lead (6x5 mm Body), 8-lead (Tape and Reel)<br>PA = Plastic DIP (300 mil Body), 8-lead<br>OA = Plastic SOIC (150 mil Body), 8-lead<br>OA713 = Plastic SOIC (150 mil Body), 8-lead (Tape and Reel) |                        |   |
|                    |                          | *All package offerings are Pb Free (Lead Free).  |                        |   |

# TC4451/TC4452

---

NOTES:



---

**Note the following details of the code protection feature on Microchip devices:**

- Microchip products meet the specification contained in their particular Microchip Data Sheet.
- Microchip believes that its family of products is one of the most secure families of its kind on the market today, when used in the intended manner and under normal conditions.
- There are dishonest and possibly illegal methods used to breach the code protection feature. All of these methods, to our knowledge, require using the Microchip products in a manner outside the operating specifications contained in Microchip's Data Sheets. Most likely, the person doing so is engaged in theft of intellectual property.
- Microchip is willing to work with the customer who is concerned about the integrity of their code.
- Neither Microchip nor any other semiconductor manufacturer can guarantee the security of their code. Code protection does not mean that we are guaranteeing the product as "unbreakable."

Code protection is constantly evolving. We at Microchip are committed to continuously improving the code protection features of our products. Attempts to break Microchip's code protection feature may be a violation of the Digital Millennium Copyright Act. If such acts allow unauthorized access to your software or other copyrighted work, you may have a right to sue for relief under that Act.

---

Information contained in this publication regarding device applications and the like is provided only for your convenience and may be superseded by updates. It is your responsibility to ensure that your application meets with your specifications. MICROCHIP MAKES NO REPRESENTATIONS OR WARRANTIES OF ANY KIND WHETHER EXPRESS OR IMPLIED, WRITTEN OR ORAL, STATUTORY OR OTHERWISE, RELATED TO THE INFORMATION, INCLUDING BUT NOT LIMITED TO ITS CONDITION, QUALITY, PERFORMANCE, MERCHANTABILITY OR FITNESS FOR PURPOSE. Microchip disclaims all liability arising from this information and its use. Use of Microchip devices in life support and/or safety applications is entirely at the buyer's risk, and the buyer agrees to defend, indemnify and hold harmless Microchip from any and all damages, claims, suits, or expenses resulting from such use. No licenses are conveyed, implicitly or otherwise, under any Microchip intellectual property rights.

**Trademarks**

The Microchip name and logo, the Microchip logo, dsPIC, KEELOQ, KEELOQ logo, MPLAB, PIC, PICmicro, PICSTART, PIC<sup>32</sup> logo, rPIC and UNI/O are registered trademarks of Microchip Technology Incorporated in the U.S.A. and other countries.

FilterLab, Hampshire, HI-TECH C, Linear Active Thermistor, MXDEV, MXLAB, SEEVAL and The Embedded Control Solutions Company are registered trademarks of Microchip Technology Incorporated in the U.S.A.

Analog-for-the-Digital Age, Application Maestro, chipKIT, chipKIT logo, CodeGuard, dsPICDEM, dsPICDEM.net, dsPICworks, dsSPEAK, ECAN, ECONOMONITOR, FanSense, HI-TIDE, In-Circuit Serial Programming, ICSP, Mindi, MiWi, MPASM, MPLAB Certified logo, MPLIB, MPLINK, mTouch, Omniscient Code Generation, PICC, PICC-18, PICDEM, PICDEM.net, PICKit, PICtail, REAL ICE, rLAB, Select Mode, Total Endurance, TSHARC, UniWinDriver, WiperLock and ZENA are trademarks of Microchip Technology Incorporated in the U.S.A. and other countries.

SQTP is a service mark of Microchip Technology Incorporated in the U.S.A.

All other trademarks mentioned herein are property of their respective companies.

© 2006-2012, Microchip Technology Incorporated, Printed in the U.S.A., All Rights Reserved.

 Printed on recycled paper.

ISBN: 978-1-62076-077-2

**QUALITY MANAGEMENT SYSTEM**  
**CERTIFIED BY DNV**  
**== ISO/TS 16949 ==**

*Microchip received ISO/TS-16949:2009 certification for its worldwide headquarters, design and wafer fabrication facilities in Chandler and Tempe, Arizona; Gresham, Oregon and design centers in California and India. The Company's quality system processes and procedures are for its PIC<sup>®</sup> MCUs and dsPIC<sup>®</sup> DSCs, KEELOQ<sup>®</sup> code hopping devices, Serial EEPROMs, microperipherals, nonvolatile memory and analog products. In addition, Microchip's quality system for the design and manufacture of development systems is ISO 9001:2000 certified.*



# MICROCHIP

## Worldwide Sales and Service

### AMERICAS

**Corporate Office**  
2355 West Chandler Blvd.  
Chandler, AZ 85224-6199  
Tel: 480-792-7200  
Fax: 480-792-7277  
Technical Support:  
<http://www.microchip.com/support>  
Web Address:  
[www.microchip.com](http://www.microchip.com)

**Atlanta**  
Duluth, GA  
Tel: 678-957-9614  
Fax: 678-957-1455

**Boston**  
Westborough, MA  
Tel: 774-760-0087  
Fax: 774-760-0088

**Chicago**  
Itasca, IL  
Tel: 630-285-0071  
Fax: 630-285-0075

**Cleveland**  
Independence, OH  
Tel: 216-447-0464  
Fax: 216-447-0643

**Dallas**  
Addison, TX  
Tel: 972-818-7423  
Fax: 972-818-2924

**Detroit**  
Farmington Hills, MI  
Tel: 248-538-2250  
Fax: 248-538-2260

**Indianapolis**  
Noblesville, IN  
Tel: 317-773-8323  
Fax: 317-773-5453

**Los Angeles**  
Mission Viejo, CA  
Tel: 949-462-9523  
Fax: 949-462-9608

**Santa Clara**  
Santa Clara, CA  
Tel: 408-961-6444  
Fax: 408-961-6445

**Toronto**  
Mississauga, Ontario,  
Canada  
Tel: 905-673-0699  
Fax: 905-673-6509

### ASIA/PACIFIC

**Asia Pacific Office**  
Suites 3707-14, 37th Floor  
Tower 6, The Gateway  
Harbour City, Kowloon  
Hong Kong  
Tel: 852-2401-1200  
Fax: 852-2401-3431

**Australia - Sydney**  
Tel: 61-2-9868-6733  
Fax: 61-2-9868-6755

**China - Beijing**  
Tel: 86-10-8569-7000  
Fax: 86-10-8528-2104

**China - Chengdu**  
Tel: 86-28-8665-5511  
Fax: 86-28-8665-7889

**China - Chongqing**  
Tel: 86-23-8980-9588  
Fax: 86-23-8980-9500

**China - Hangzhou**  
Tel: 86-571-2819-3187  
Fax: 86-571-2819-3189

**China - Hong Kong SAR**  
Tel: 852-2401-1200  
Fax: 852-2401-3431

**China - Nanjing**  
Tel: 86-25-8473-2460  
Fax: 86-25-8473-2470

**China - Qingdao**  
Tel: 86-532-8502-7355  
Fax: 86-532-8502-7205

**China - Shanghai**  
Tel: 86-21-5407-5533  
Fax: 86-21-5407-5066

**China - Shenyang**  
Tel: 86-24-2334-2829  
Fax: 86-24-2334-2393

**China - Shenzhen**  
Tel: 86-755-8203-2660  
Fax: 86-755-8203-1760

**China - Wuhan**  
Tel: 86-27-5980-5300  
Fax: 86-27-5980-5118

**China - Xian**  
Tel: 86-29-8833-7252  
Fax: 86-29-8833-7256

**China - Xiamen**  
Tel: 86-592-2388138  
Fax: 86-592-2388130

**China - Zhuhai**  
Tel: 86-756-3210040  
Fax: 86-756-3210049

### ASIA/PACIFIC

**India - Bangalore**  
Tel: 91-80-3090-4444  
Fax: 91-80-3090-4123

**India - New Delhi**  
Tel: 91-11-4160-8631  
Fax: 91-11-4160-8632

**India - Pune**  
Tel: 91-20-2566-1512  
Fax: 91-20-2566-1513

**Japan - Osaka**  
Tel: 81-66-152-7160  
Fax: 81-66-152-9310

**Japan - Yokohama**  
Tel: 81-45-471-6166  
Fax: 81-45-471-6122

**Korea - Daegu**  
Tel: 82-53-744-4301  
Fax: 82-53-744-4302

**Korea - Seoul**  
Tel: 82-2-554-7200  
Fax: 82-2-558-5932 or  
82-2-558-5934

**Malaysia - Kuala Lumpur**  
Tel: 60-3-6201-9857  
Fax: 60-3-6201-9859

**Malaysia - Penang**  
Tel: 60-4-227-8870  
Fax: 60-4-227-4068

**Philippines - Manila**  
Tel: 63-2-634-9065  
Fax: 63-2-634-9069

**Singapore**  
Tel: 65-6334-8870  
Fax: 65-6334-8850

**Taiwan - Hsin Chu**  
Tel: 886-3-5778-366  
Fax: 886-3-5770-955

**Taiwan - Kaohsiung**  
Tel: 886-7-536-4818  
Fax: 886-7-330-9305

**Taiwan - Taipei**  
Tel: 886-2-2500-6610  
Fax: 886-2-2508-0102

**Thailand - Bangkok**  
Tel: 66-2-694-1351  
Fax: 66-2-694-1350

### EUROPE

**Austria - Wels**  
Tel: 43-7242-2244-39  
Fax: 43-7242-2244-393

**Denmark - Copenhagen**  
Tel: 45-4450-2828  
Fax: 45-4485-2829

**France - Paris**  
Tel: 33-1-69-53-63-20  
Fax: 33-1-69-30-90-79

**Germany - Munich**  
Tel: 49-89-627-144-0  
Fax: 49-89-627-144-44

**Italy - Milan**  
Tel: 39-0331-742611  
Fax: 39-0331-466781

**Netherlands - Drunen**  
Tel: 31-416-690399  
Fax: 31-416-690340

**Spain - Madrid**  
Tel: 34-91-708-08-90  
Fax: 34-91-708-08-91

**UK - Wokingham**  
Tel: 44-118-921-5869  
Fax: 44-118-921-5820

11/29/11

Компания «Life Electronics» занимается поставками электронных компонентов импортного и отечественного производства от производителей и со складов крупных дистрибьюторов Европы, Америки и Азии.

С конца 2013 года компания активно расширяет линейку поставок компонентов по направлению коаксиальный кабель, кварцевые генераторы и конденсаторы (керамические, пленочные, электролитические), за счёт заключения дистрибьюторских договоров

Мы предлагаем:

- Конкурентоспособные цены и скидки постоянным клиентам.
- Специальные условия для постоянных клиентов.
- Подбор аналогов.
- Поставку компонентов в любых объемах, удовлетворяющих вашим потребностям.
- Приемлемые сроки поставки, возможна ускоренная поставка.
- Доставку товара в любую точку России и стран СНГ.
- Комплексную поставку.
- Работу по проектам и поставку образцов.
- Формирование склада под заказчика.
- Сертификаты соответствия на поставляемую продукцию (по желанию клиента).
- Тестирование поставляемой продукции.
- Поставку компонентов, требующих военную и космическую приемку.
- Входной контроль качества.
- Наличие сертификата ISO.

В составе нашей компании организован Конструкторский отдел, призванный помогать разработчикам, и инженерам.

Конструкторский отдел помогает осуществить:

- Регистрацию проекта у производителя компонентов.
- Техническую поддержку проекта.
- Защиту от снятия компонента с производства.
- Оценку стоимости проекта по компонентам.
- Изготовление тестовой платы монтаж и пусконаладочные работы.



Тел: +7 (812) 336 43 04 (многоканальный)  
Email: [org@lifeelectronics.ru](mailto:org@lifeelectronics.ru)