

FPC/FFC Connectors

OMRON

XF Series



Connect to your future applications



XF3A

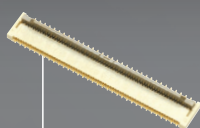

XF3B



XF3C

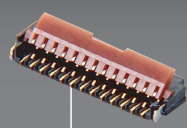

XF3Z **NEW**

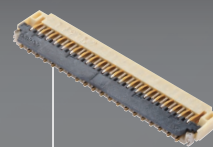

XF3H

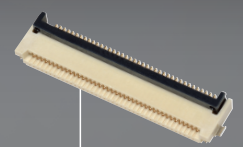

XF3M



XF2B



XF2J



XF2L

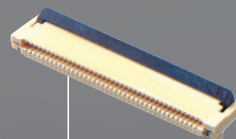

XF2M

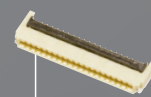



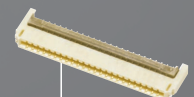







XF2U

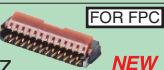

XF2W

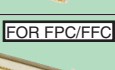
INDEX

Product Overview

Model	Lock mechanism	Pitch	On-board height	Depth (*4)	Applicable FPC/ FFC thickness	Contact type	Page
 <small>FOR FPC</small> XF3C	Rotary backlock	0.25mm	0.85mm	3.8mm	0.12mm	Dual contact	P6
 <small>FOR FPC</small> XF3A	Rotary backlock	0.3mm	0.6mm	3.8mm	0.12mm	Upper contact	P7
 <small>FOR FPC</small> XF3B	Rotary backlock	0.3mm	0.9mm	4.0mm *3	0.2mm	Dual contact	P8
 <small>FOR FPC</small> XF2B	Rotary backlock	0.3mm	1.2mm	5.5mm	0.2mm	Dual contact *1	P9
 <small>FOR FPC</small> NEW XF3Z	Rotary frontlock	0.3mm	1.0mm	3.5mm	0.2mm	Lower contact	P10
 <small>FOR FPC</small> XF3H	Rotary frontlock	0.3mm	0.95mm	3.5mm	0.2mm	Lower contact	P11
 <small>FOR FPC</small> XF2U	Rotary backlock	0.5mm	0.9mm	3.5mm	0.2mm	Dual contact	P12
 <small>FOR FPC/FFC</small> XF2W	Rotary backlock	0.5mm	1.1mm	3.5mm *3	0.3mm	Dual contact	P13
 <small>FOR FPC/FFC</small> XF3M	Rotary backlock	0.5mm	2.0mm	6.4mm *6	0.3mm	Dual/upper contact	P15
		1.0mm					P17
 <small>FOR FPC/FFC</small> XF2M	Rotary backlock	0.5mm	2.0mm *2	5.9mm *2	0.3mm	Dual contact	P18
 <small>FOR FPC</small> XF2L	Slide lock	0.5mm	1.2mm	3.45mm	0.3mm	Upper/lower contact	P19
 <small>FOR FPC/FFC</small> XF2J	Slide lock	0.5mm	4.15mm *5	3.45mm	0.3mm	Single-sided contact	P20

*1: Models with 61 pins have upper contacts.

*2: Dimensions of multiple type is different.

*3: 4.1 mm for more than 45 pins.

*4: These are latch closed dimension.

*5: 4.25 mm for 40 pins.

*6: Easy-operation type is different.

Model Number Legend

* Use this legend when determining the product specifications from the model number. Choose from the model numbers listed in this catalog when ordering.

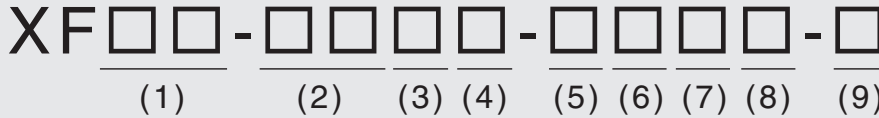

(1) Classification in Series
2B, 2J, 2L, 2M, 2U, 2W,
3A, 3B, 3C, 3H, 3M, 3M(1), 3Z

(2) Number of Signal Contact Pins

(3) Signal Contact Arrangement
1: One-row, double-sided contact
2: One-row, single-sided contact
(including upper contact and top entry)

3: One-row, single-sided contact
(lower contact)
4: Two-row, double-sided contact
5: Two-row, single-sided contact

(4) Terminal Shape
4: SMT terminals
(top entry)
5: SMT terminals
(side entry)

(5) Applicable FPC thickness
1: 0.3mm
3: 0.2mm
4: 0.12mm

(6) Terminal Arrangement
□: Standard
1: Staggered arrangement
(forward arrangement)
2: Staggered arrangement
(backward arrangement)

(7) Plating
A: Au
B: Au flash
D: Sn

(8) Identification code
(9) Special Correspondence
R100: 100pcs
*Only XF2J, XF2M, XF2W,
XF3M, XF3M(1)

Applications



■ Mobile phones

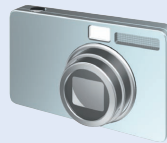

■ Digital cameras



■ Digital music players



■ Storage Device



■ Digital video cameras

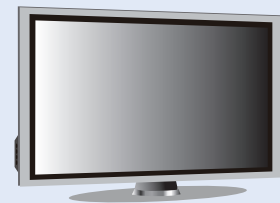

■ LCD-TV, PDP-TV



■ Ultra sound



■ Electricity meter



■ Surveillance camera

Features of Rotary Backlock Mechanism

Feature 1

Rotary latch is independent of the FPC socket

➔ **The Rotary latch will not release if the FPC is lifted.**

High reliability – A mounted FPC will not detach even if excess force is applied to it.

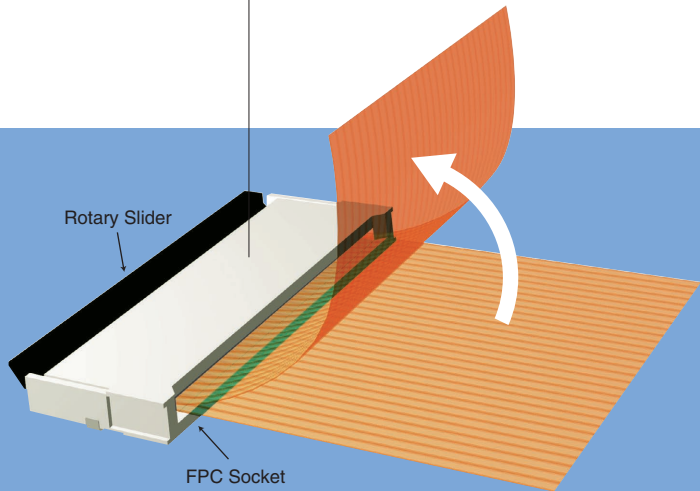

Feature 2

Four-sided housing

➔ **Construction prevents FPC displacement.**

Mounting reliability is enhanced because the FPC is held in a four-sided housing and is unaffected by the slider operation.

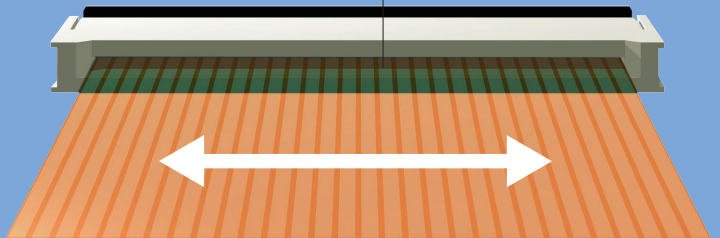

Tradition Rotary Connector

1. Mount the connector.

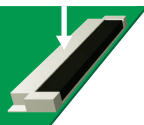

2. Release the rotary latch.

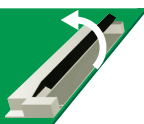

3. Insert the FPC.

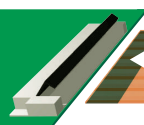

4. Lock the rotary latch.

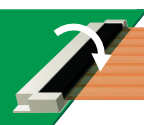

Rotary Backlock Mechanism Connector

1. Mount the connector.

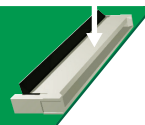

2. Insert the FPC.

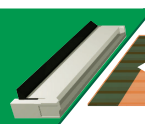

3. Lock the rotary slider.



Feature 3

Dual contact

* Except the XF3A series and XF2B-61 pin.

➔ **There is no need to distinguish between the upper and lower FPC connection.**

The contacts make contact from both sides, so there is no need to distinguish between upper and lower contacts when connecting PCBs.

Feature 4

Delivered with the rotary latch open.

➔ **Less work required for FPC Mounting.**

Compared with traditional rotary lock connectors, production efficiency is greatly improved because there is no need to take the additional step of opening the latch.

Introduction of Product

XF3M

Improved insertion into FPC/FFC cable connectors with sure lock feeling to confirm proper connection.

- Models available with 0.5-mm or 1.0-mm pitch with the same structure.
- Models available with dual contacts or upper contacts. (Models with upper contacts come only with a 0.5-mm pitch.)
- Models available with gold or tin plating. (Tin plating is available only with models with dual contacts.)
- Models with 80 pins (multiple type) available with 0.5-mm pitch.
- Rotary backlock mechanism.
- Connectors are delivered with the lock lever rotated to an upright position to facilitate solder inspection after mounting.

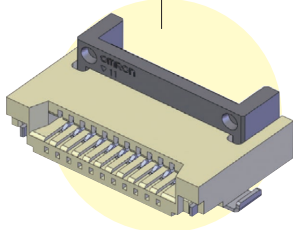

Connector Specifications

Pitch	0.5mm 1.0mm
Height	2.0mm
Depth	6.4mm
FPC thickness	0.3mm
Contact orientation	Dual/Upper contact
Lock mechanism	Rotary backlock mechanism

Improved FPC/FFC Insertion and Lock Feeling

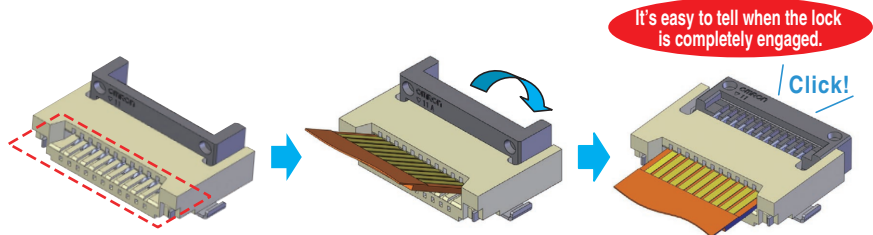

The insertion opening is easy to see.

Supports a Wide Range of Connection Applications

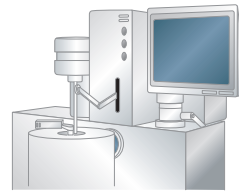
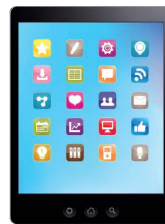

XF3A

Ultra-low profile with an on-board height of 0.6mm.

- Ultra-low construction supports LCR downsizing.
- Rotary backlock mechanism.
- For upper contacts only.

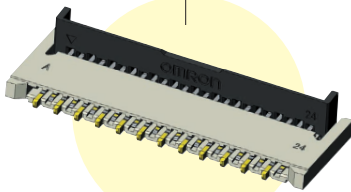

Connector Specifications

Pitch	0.3mm
Height	0.6mm
Depth	3.8mm
FPC thickness	0.12mm
Contact orientation	Upper contact
Lock mechanism	Rotary backlock mechanism

ZIF structure with 0.6mm on-board height

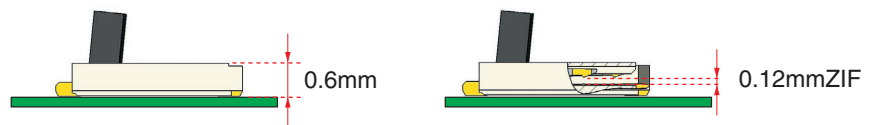

Contribute to Downsizing of Mobile Devices

Possible to downsize compare with existing connectors.

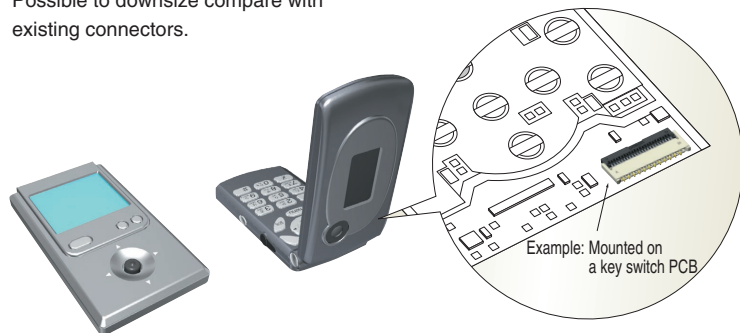

XF3C

For FPC

Rotary Backlock Connector (0.25-mm Pitch, Dual Contact)

0.25-mm Pitch with Dual contact and Rotary Backlock Mechanism

- Wide molding wall on the rear bottom of the connector allows greater freedom in board design.
- Dual contact.
- Gold plated with an applicable FPC thickness of 0.12 mm.
- Halogen Free (*)

* OMRON uses the following standard to determine halogen-free construction: 900 ppm max. for Br, 900 ppm max. for Cl, and 1,500 ppm max. for Br+Cl.

RoHS compliant

■ Ratings and Specifications

Rated current	0.2 A AC/DC
Rated voltage	50 V AC/DC
Contact resistance	80 mΩ max. (at 20 mV DC max., 100 mA max.)
Insulation resistance	100 MΩ min. (at 250 V DC)
Dielectric strength	250 V AC for 1 min. (leakage current: 1 mA max.)
Insertion durability	20 times
Ambient operating temperature	-30 to 85 °C (With no icing or condensation)

■ Materials and Finish

Housing	LCP resin (UL94 V-0)/natural
Slider	LCP resin (UL94 V-0)/black
Contacts	Spring copper alloy/nickel substrate (2 μm) Gold-plated contacts (0.15 μm)

■ Dimensions

XF3C-□□45-41A

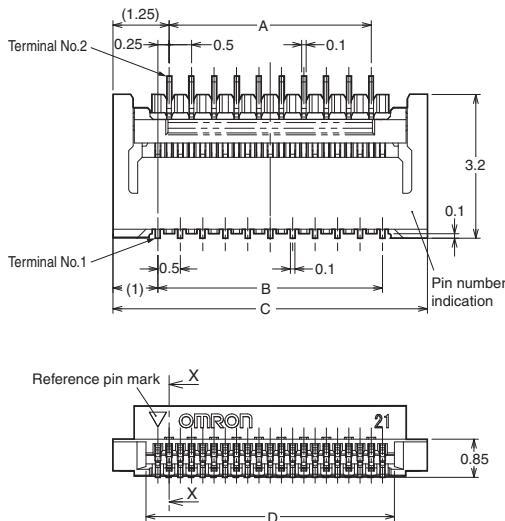
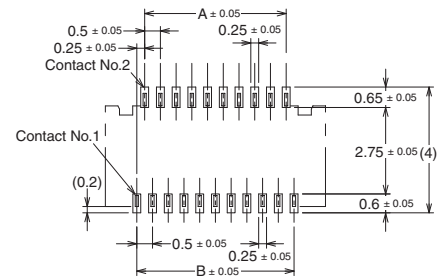

Table of Dimensions

Pins ^{*1}	Model	A	B	C	D
17	XF3C-1745-41A	3.5	4.0	6.0	4.55
19	XF3C-1945-41A	4.0	4.5	6.5	5.05
23	XF3C-2345-41A	5.0	5.5	7.5	6.05
25	XF3C-2545-41A	5.5	6.0	8.0	6.55
35	XF3C-3545-41A	8.0	8.5	10.5	9.05
45	XF3C-4545-41A	10.5	11.0	13.0	11.55
51	XF3C-5145-41A	12.0	12.5	14.5	13.05
59	XF3C-5945-41A	14.0	14.5	16.5	15.05

PCB Dimensions (TOP VIEW)



Recommended FPC Dimensions

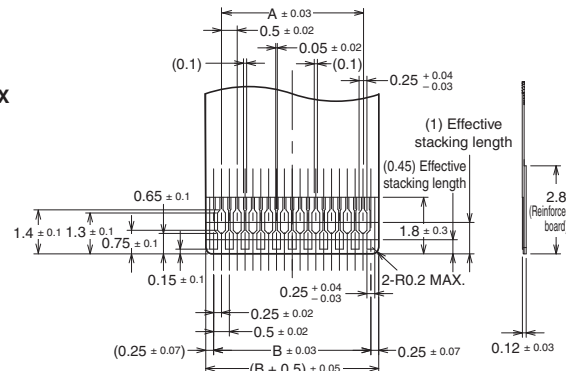

Cross-section diagram: X-X

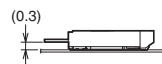

■ Ordering Information

Pins ^{*1}	Model	Quantity per reel (unit) ^{*2}
17	XF3C-1745-41A	2,000
19	XF3C-1945-41A	
23	XF3C-2345-41A	
25	XF3C-2545-41A	
35	XF3C-3545-41A	
45	XF3C-4545-41A	
51	XF3C-5145-41A	
59	XF3C-5945-41A	

- *1. Please consult your OMRON representative for available pin count.
*2. Please order by integer multiple of the quantity per reel.

XF3A

For FPC

Rotary Backlock Connector (0.3-mm Pitch, Upper Contact)

On-board height 0.6 mm, the lowest class profile in the industry. Rotary Backlock Connectors with 0.3-mm pitch.

- Wide molding wall on the rear bottom of the connector allows greater freedom in board design.
- Upper Contact
- Gold plated with an applicable FPC thickness of 0.2 mm.
- Halogen Free (*)

* OMRON uses the following standard to determine halogen-free construction: 900 ppm max. for Br, 900 ppm max. for Cl, and 1,500 ppm max. for Br+Cl.



RoHS compliant

■ Ratings and Specifications

Rated current	0.2 A AC/DC
Rated voltage	50 V AC/DC
Contact resistance	80 mΩ max. (at 20 mV DC max., 100 mA max.)
Insulation resistance	100 MΩ min. (at 250 V DC)
Dielectric strength	250 V AC for 1 min. (leakage current: 1 mA max.)
Insertion durability	10 times
Ambient operating temperature	-30 to 85 °C (With no icing or condensation)

■ Materials and Finish

Housing	LCP resin (UL94 V-0)/natural
Slider	LCP resin (UL94 V-0)/black
Contacts	Spring copper alloy/nickel substrate (2 μm) Gold-plated contacts (0.15 μm)

■ Dimensions

XF3A-□□55-41A

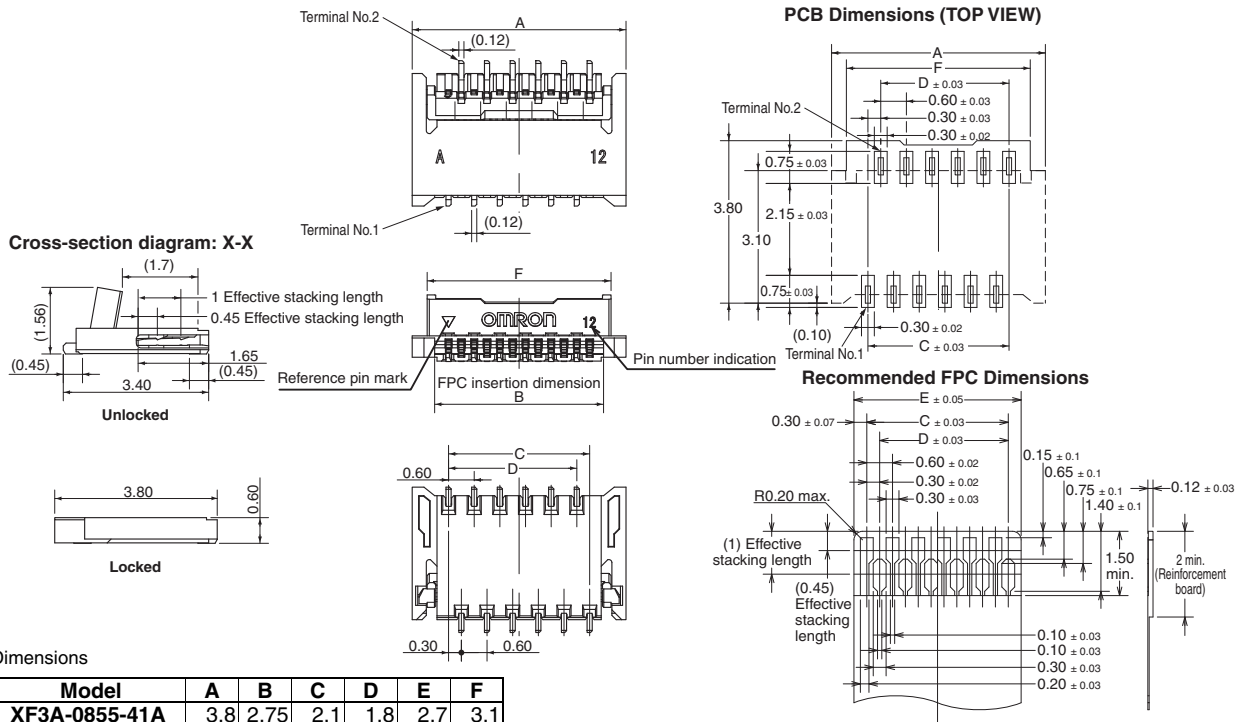

Table of Dimensions

Pins ^{*1}	Model	A	B	C	D	E	F
8	XF3A-0855-41A	3.8	2.75	2.1	1.8	2.7	3.1
12	XF3A-1255-41A	5.0	3.95	3.3	3.0	3.9	4.3
17	XF3A-1755-41A	6.5	5.45	4.8	4.2	5.4	5.8
23	XF3A-2355-41A	8.3	7.25	6.6	6.0	7.2	7.6
25	XF3A-2555-41A	8.9	7.85	7.2	6.6	7.8	8.2
51	XF3A-5155-41A	16.7	15.65	15.0	14.4	15.6	16.0

■ Ordering Information

Pins ^{*1}	Model	Quantity per reel (unit) ^{*2}
8	XF3A-0855-41A	4,000
12	XF3A-1255-41A	
17	XF3A-1755-41A	
23	XF3A-2355-41A	
25	XF3A-2555-41A	
51	XF3A-5155-41A	

- *1. Please consult your OMRON representative for available pin count.
*2. Please order by integer multiple of the quantity per reel.

XF3B

For FPC

Rotary Backlock Connector (0.3-mm Pitch, Dual Contact)

Rotary Backlock Mechanism with 0.3-mm Pitch and Low Profile of 0.9 mm

- Wide molding wall on the rear bottom of the connector allows greater freedom in board design.
- Dual contact model to enhance the contact structure of lower contact.
- Gold plated with an applicable FPC thickness of 0.2 mm.
- Halogen Free (*)

* OMRON uses the following standard to determine halogen-free construction: 900 ppm max. for Br, 900 ppm max. for Cl, and 1,500 ppm max. for Br+Cl.

RoHS compliant



■ Ratings and Specifications

Rated current	0.2 A AC/DC
Rated voltage	50 V AC/DC
Contact resistance	80 mΩ max. (at 20 mV DC max., 100 mA max.)
Insulation resistance	100 MΩ min. (at 250 V DC)
Dielectric strength	250 V AC for 1 min. (leakage current: 1 mA max.)
Insertion durability	20 times
Ambient operating temperature	-30 to 85 °C (With no icing or condensation)

■ Materials and Finish

Housing	LCP resin (UL94 V-0)/natural
Slider	LCP resin (UL94 V-0)/brown
Contacts	Spring copper alloy/nickel substrate (2 μm) Gold-plated contacts (0.15 μm)

■ Dimensions

XF3B-□□45-31A
XF3B-□□45-31AE

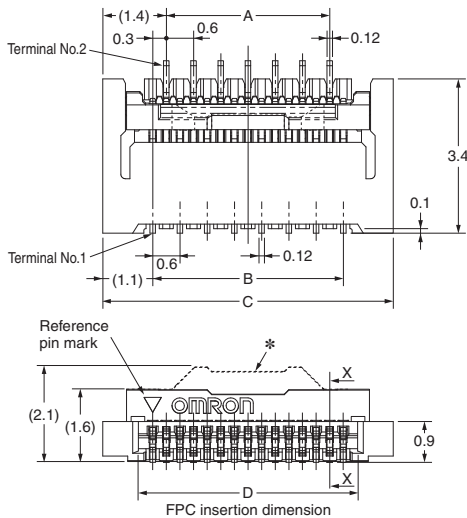

Cross-section diagram: X-X

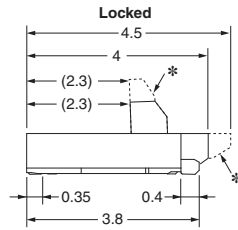

* Dotted lines indicate the shape and dimensions of the XF3B-□□45-31AE connectors.

Table of Dimensions

Pins ^{*1}	Model	A	B	C	D
8	XF3B-0845-31A	1.8	2.1	4.3	2.75
19	XF3B-1945-31A	4.8	5.4	7.6	6.05
25	XF3B-2545-31A	6.6	7.2	9.4	7.85
35	XF3B-3545-31A	9.6	10.2	12.4	10.85
51	XF3B-5145-31AE	14.4	15.0	17.2	15.65
67	XF3B-6745-31AE	19.2	19.8	22.0	20.45

PCB Dimensions (TOP VIEW)

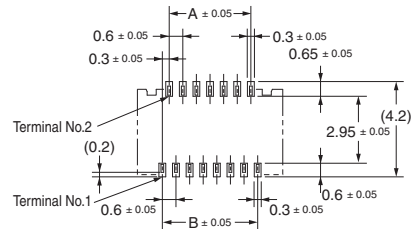

Recommended FPC Dimensions

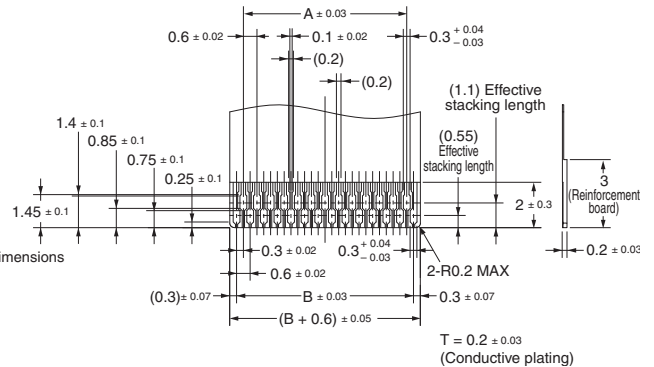

■ Ordering Information

Pins ^{*1}	Model	Quantity per reel (unit) ^{*2}
8	XF3B-0845-31A	2,000
19	XF3B-1945-31A	
25	XF3B-2545-31A	
35	XF3B-3545-31A	
51	XF3B-5145-31AE	1,500
67	XF3B-6745-31AE	

- *1. Please consult your OMRON representative for available pin count.
- *2. Please order by integer multiple of the quantity per reel.

XF2B

For FPC

Rotary Backlock Connector (0.3-mm Pitch, Dual Contact)

Rotary Backlock Mechanism with 0.3-mm Pitch

- Wide molding wall on the rear bottom of the connector allows greater freedom in board design.
- Dual contact reduces the number of parts.
- Gold plated with an applicable FPC thickness of 0.2 mm.
- Halogen Free (*)

* OMRON uses the following standard to determine halogen-free construction: 900 ppm max. for Br, 900 ppm max. for Cl, and 1,500 ppm max. for Br+Cl.

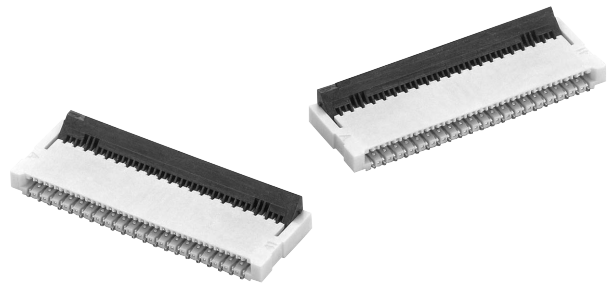

RoHS compliant

■ Ratings and Specifications

Rated current	0.2 A AC/DC
Rated voltage	50 V AC/DC
Contact resistance	50 mΩ max. (at 20 mV DC max., 100 mA max.)
Insulation resistance	100 MΩ min. (at 250 V DC)
Dielectric strength	250 V AC for 1 min. (leakage current: 1 mA max.)
Insertion durability	20 times
Ambient operating temperature	-30 to 85 °C (With no icing or condensation)

■ Materials and Finish

Housing	LCP resin (UL94 V-0)/natural
Slider	LCP resin (UL94 V-0)/black
Contacts	Spring copper alloy/nickel substrate (2 μm) Gold-plated contacts (0.15 μm)

■ Dimensions

XF2B-□□□5-31A

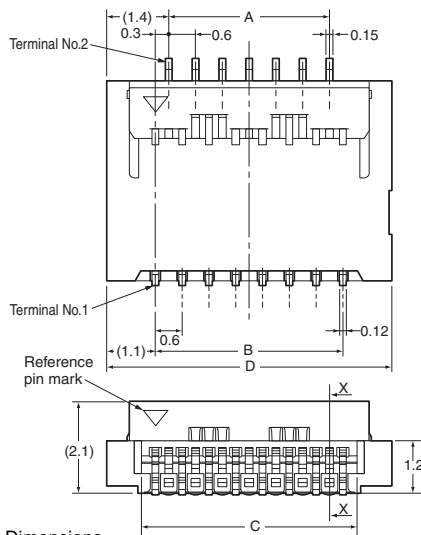
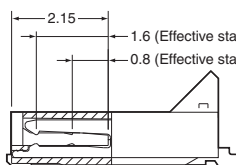

Table of Dimensions

Pins ^{*1}	Model	A	B	C	D
17	XF2B-1745-31A	4.2	4.8	5.5	7.0
21	XF2B-2145-31A	5.4	6.0	6.7	8.2
23	XF2B-2345-31A	6.0	6.6	7.3	8.8
25	XF2B-2545-31A	6.6	7.2	7.9	9.4
27	XF2B-2745-31A	7.2	7.8	8.5	10.0
31	XF2B-3145-31A	8.4	9.0	9.7	11.2
33	XF2B-3345-31A	9.0	9.6	10.3	11.8
35	XF2B-3545-31A	9.6	10.2	10.9	12.4
39	XF2B-3945-31A	10.8	11.4	12.1	13.6
41	XF2B-4145-31A	11.4	12.0	12.7	14.2
45	XF2B-4545-31A	12.6	13.2	13.9	15.4
51	XF2B-5145-31A	14.4	15.0	15.7	17.2
61	XF2B-6155-31A	17.4	18.0	18.7	20.2

Cross-section diagram: X-X



PCB Dimensions (TOP VIEW)

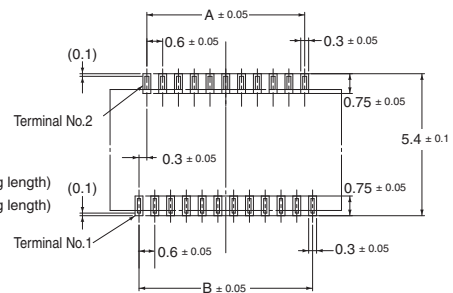

Recommended FPC Dimensions

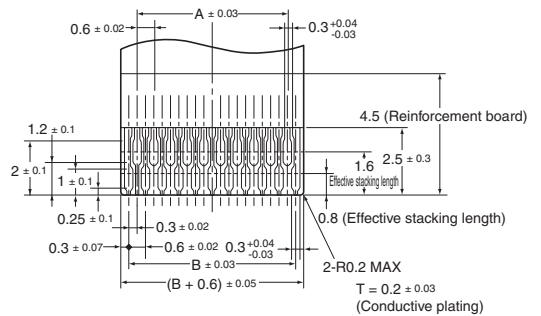

■ Ordering Information

Pins ^{*1}	Model	Pins ^{*1}	Model	Quantity per reel (unit) ^{*2}
17	XF2B-1745-31A	35	XF2B-3545-31A	1,500
21	XF2B-2145-31A	39	XF2B-3945-31A	
23	XF2B-2345-31A	41	XF2B-4145-31A	
25	XF2B-2545-31A	45	XF2B-4545-31A	
27	XF2B-2745-31A	51	XF2B-5145-31A	
31	XF2B-3145-31A	61	XF2B-6155-31A ^{*3}	
33	XF2B-3345-31A	-	-	

- *1. Please consult your OMRON representative for available pin count.
- *2. Please order by integer multiple of the quantity per reel.
- *3. Upper contact.

XF3Z

For FPC

Rotary Frontlock Connector (0.3-mm Pitch, Lower Contact)

High-reliability rotary-front-lock with 0.3-mm pitch and low profile

- Ultra-slim connector with a depth of 3.5 mm.
- Wide molding wall on the rear bottom of the connector allows greater freedom in board design.
- Slider open locking mechanism makes work efficient.
- Gold plated with an applicable FPC thickness of 0.2 mm.
- Halogen Free (*)

* OMRON uses the following standard to determine halogen-free construction: 900 ppm max. for Br, 900 ppm max. for Cl, and 1,500 ppm max. for Br+Cl

RoHS compliant

NEW

■ Ratings and Specifications

Rated current	0.2 A AC/DC
Rated voltage	50 V AC/DC
Contact resistance	80 mΩ max. (at 20 mV DC max., 100 mA max.)
Insulation resistance	100 MΩ min. (at 250 V DC)
Dielectric strength	250 V AC for 1 min. (leakage current: 1 mA max.)
Insertion durability	20 times
Ambient operating temperature	-55 to 85 °C (With no icing or condensation)

■ Materials and Finish

Housing	LCP resin (UL94 V-0)/black
Slider	PA resin (UL94 HB)/brown
Contacts	Spring copper alloy/nickel substrate (1.5 μm) Gold-plated contacts (flash)
Hold-down	Copper alloy/tin plating (1 μm)

■ Dimensions

XF3Z-□□55-31B

XF3Z

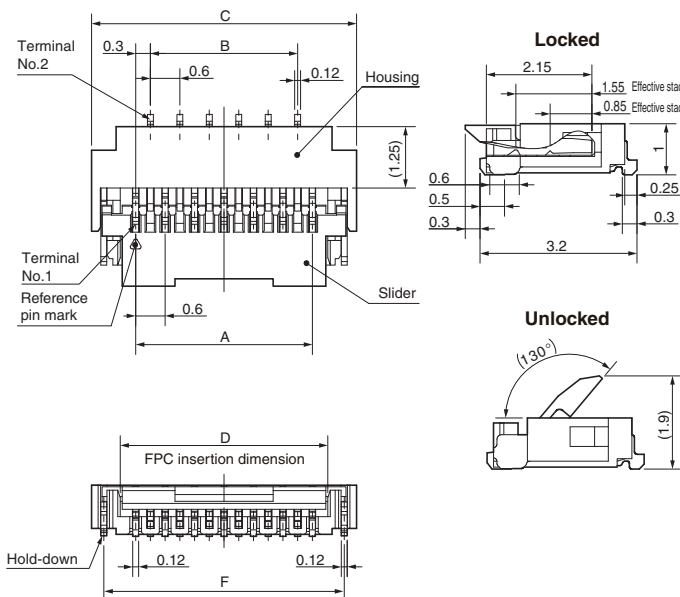

PCB Dimensions (TOP VIEW)

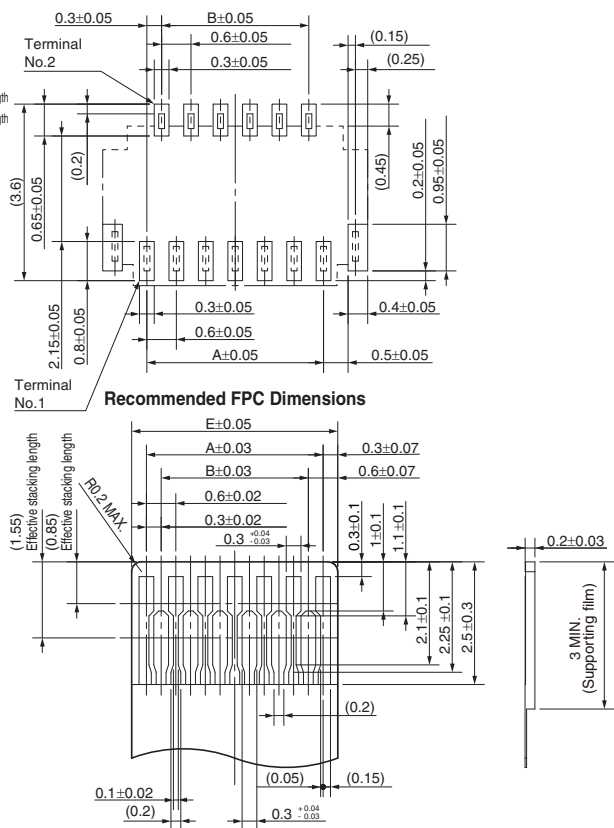

Table of Dimensions

Pins *1	Model	A	B	C	D	E	F
13	XF3Z-1355-31B	3.6	3.0	5.4	4.23	4.2	4.9
25	XF3Z-2555-31B	7.2	6.6	9.0	7.83	7.8	8.5
(35)	XF3Z-3555-31B	10.2	9.6	12.0	10.83	10.8	11.5

■ Ordering Information

Pins *1	Model	Quantity per reel (unit) *2
13	XF3Z-1355-31B	3000
25	XF3Z-2555-31B	
(35)	XF3Z-3555-31B	

- *1. Please consult your OMRON representative for available pin count. Please consult your OMRON representative for the marketing dates for pin counts in parentheses.
- *2. Please order by integer multiple of the quantity per reel.

XF3H

Rotary Frontlock Connector (0.3-mm Pitch, Lower Contact)

For FPC

High-reliability rotary-front-lock with 0.3-mm pitch and low profile

- Ultra-slim connector with a depth of 3.5 mm.
- Wide molding wall on the rear bottom of the connector allows greater freedom in board design.
- Slider open locking mechanism makes work efficient.
- Gold plated with an applicable FPC thickness of 0.2 mm.
- Halogen Free (*)

* OMRON uses the following standard to determine halogen-free construction: 900 ppm max. for Br, 900 ppm max. for Cl, and 1,500 ppm max. for Br+Cl.

RoHS compliant

■ Ratings and Specifications

Rated current	0.2 A AC/DC
Rated voltage	50 V AC/DC
Contact resistance	80 mΩ max. (at 20 mV DC max., 100 mA max.)
Insulation resistance	100 MΩ min. (at 250 V DC)
Dielectric strength	250 V AC for 1 min. (leakage current: 1 mA max.)
Insertion durability	20 times
Ambient operating temperature	-30 to 85 °C (With no icing or condensation)

■ Materials and Finish

Housing	LCP resin (UL94 V-0)/natural
Slider	LCP resin (UL94 V-0)/black
Contacts	Spring copper alloy/nickel substrate (2 μm) Gold-plated contacts (0.15 μm)
Hold-down	Copper alloy/tin plating (2 μm)



■ Dimensions

XF3H-□□55-31AR

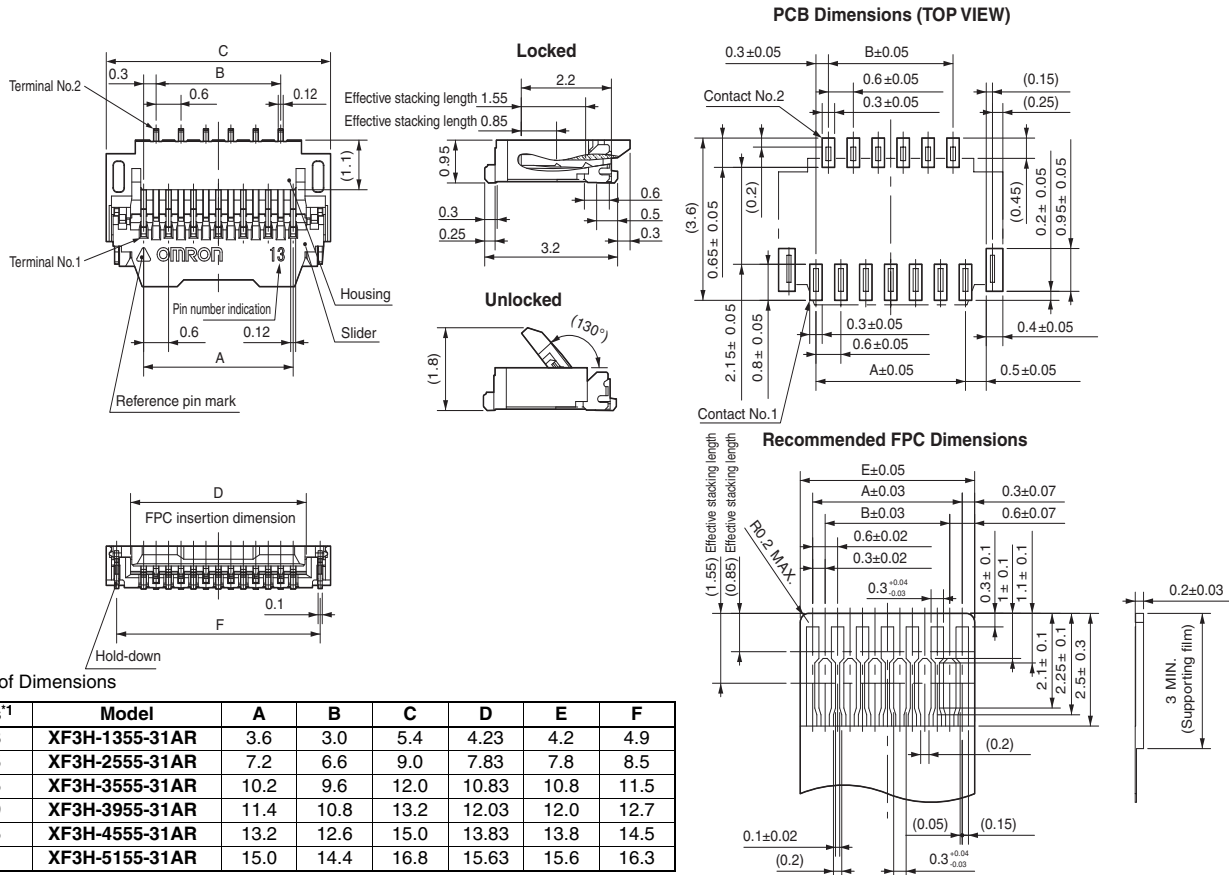

Table of Dimensions

Pins ^{*1}	Model	A	B	C	D	E	F
13	XF3H-1355-31AR	3.6	3.0	5.4	4.23	4.2	4.9
25	XF3H-2555-31AR	7.2	6.6	9.0	7.83	7.8	8.5
35	XF3H-3555-31AR	10.2	9.6	12.0	10.83	10.8	11.5
39	XF3H-3955-31AR	11.4	10.8	13.2	12.03	12.0	12.7
45	XF3H-4555-31AR	13.2	12.6	15.0	13.83	13.8	14.5
51	XF3H-5155-31AR	15.0	14.4	16.8	15.63	15.6	16.3

■ Ordering Information

Pins ^{*1}	Model	Quantity per reel (unit) ^{*2}
13	XF3H-1355-31AR	3,000
25	XF3H-2555-31AR	
35	XF3H-3555-31AR	
39	XF3H-3955-31AR	
45	XF3H-4555-31AR	
51	XF3H-5155-31AR	

*1. Please consult your OMRON representative for available pin count.

*2. Please order by integer multiple of the quantity per reel.

XF3H

Rotary Backlock Mechanism with Depth of 3.5-mm and Low Profile of 0.9 mm

- Ultra-slim connector with a depth of 3.5 mm.
- Dual contact reduces the number of parts.
- Wide molding wall on the rear bottom of the connector allows greater freedom in board design.
- Gold plated with an applicable FPC thickness of 0.2 mm.
- Halogen Free (*)

* OMRON uses the following standard to determine halogen-free construction: 900 ppm max. for Br, 900 ppm max. for Cl, and 1,500 ppm max. for Br+Cl.

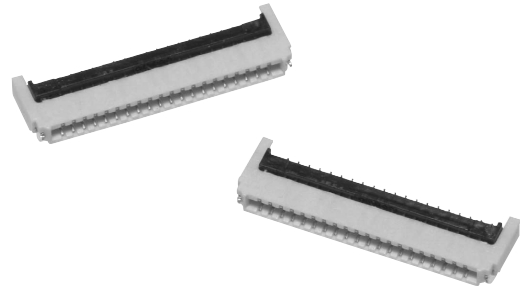

RoHS compliant

■ Ratings and Specifications

Rated current	0.5 A AC/DC
Rated voltage	50 V AC/DC
Contact resistance	60 mΩ max. (at 20 mV DC max., 100 mA max.)
Insulation resistance	100 MΩ min. (at 250 V DC)
Dielectric strength	250 V AC for 1 min. (leakage current: 1 mA max.)
Insertion durability	20 times
Ambient operating temperature	-30 to 85 °C (With no icing or condensation)

■ Materials and Finish

Housing	LCP resin (UL94 V-0)/natural
Slider	LCP resin (UL94 V-0)/black
Contacts	Spring copper alloy/nickel substrate (2 μm) Gold-plated contacts (0.15 μm)
Hold-down	Copper alloy/tin plating (2 μm)

■ Dimensions

XF2U-□□15-3A

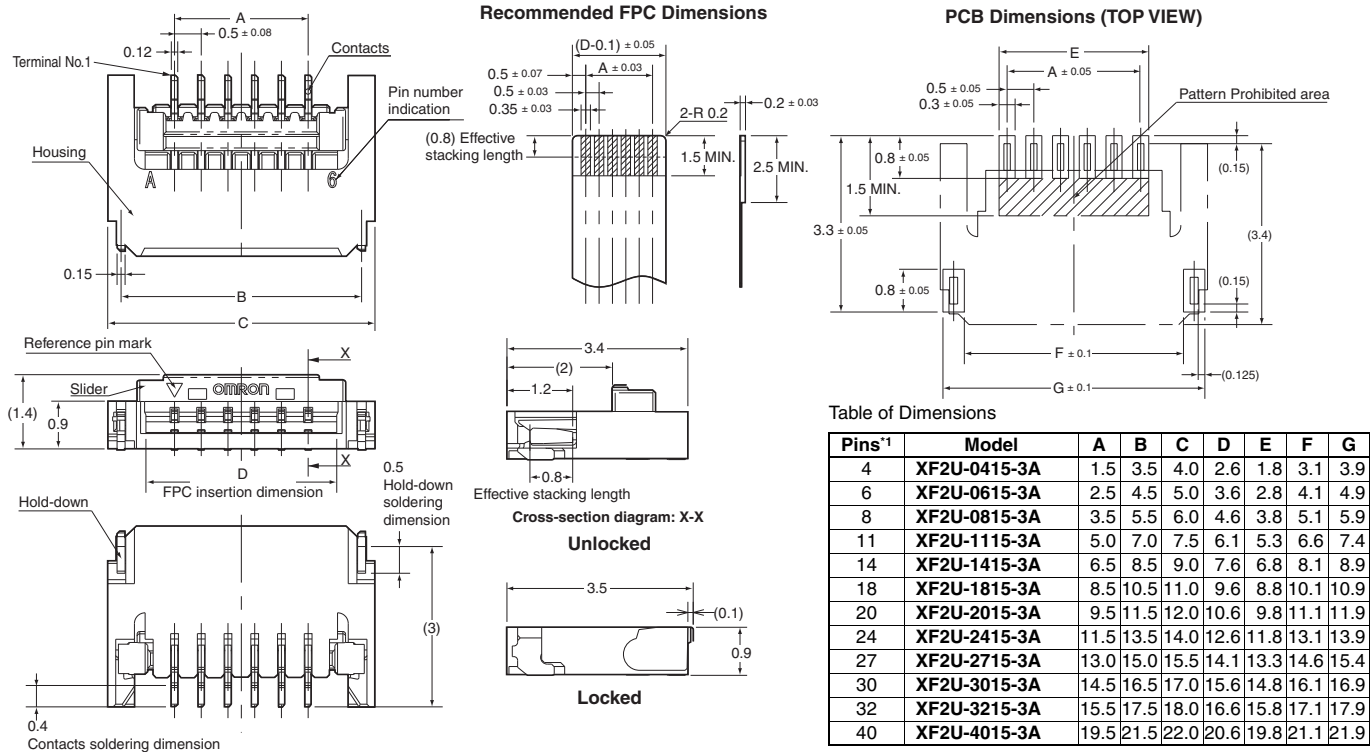

■ Ordering Information

Pins ¹	Model	Quantity per reel (unit) ²
4	XF2U-0415-3A	3,000
6	XF2U-0615-3A	
8	XF2U-0815-3A	
11	XF2U-1115-3A	
14	XF2U-1415-3A	
18	XF2U-1815-3A	
20	XF2U-2015-3A	
24	XF2U-2415-3A	
27	XF2U-2715-3A	
30	XF2U-3015-3A	
32	XF2U-3215-3A	
40	XF2U-4015-3A	

- *1. Please consult your OMRON representative for available pin count.
*2. Please order by integer multiple of the quantity per reel.

XF2W

Rotary Backlock Connector (0.5-mm Pitch, Dual Contact)

For FPC/FFC

Rotary Backlock Mechanism with 0.5-mm Pitch and Low Profile of 1.1 mm

- Two models available: Low profile connector with a depth of 3.5 mm and easy-operation connector with long slider.
- Dual contact reduces the number of parts.
- Wide molding wall on the rear bottom of the connector allows greater freedom in board design.
- Gold plated with an applicable FPC/FFC thickness of 0.3 mm.
- Halogen Free (*)

* OMRON uses the following standard to determine halogen-free construction: 900 ppm max. for Br, 900 ppm max. for Cl, and 1,500 ppm max. for Br+Cl.

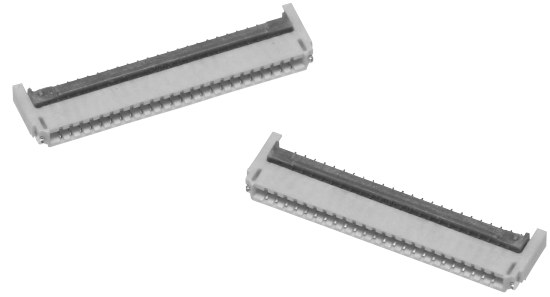

RoHS compliant

■ Ratings and Specifications

Rated current	0.5 A AC/DC
Rated voltage	50 V AC/DC
Contact resistance	60 mΩ max. (at 20 mV DC max., 100 mA max.)
Insulation resistance	100 MΩ min. (at 250 V DC)
Dielectric strength	250 V AC for 1 min. (leakage current: 1 mA max.)
Insertion durability	20 times
Ambient operating temperature	-30 to 85 °C (With no icing or condensation)

■ Materials and Finish

Housing	LCP resin (UL94 V-0)/natural
Slider	LCP resin (UL94 V-0)/brown
Contacts	Spring copper alloy/nickel substrate (2 μm) Gold-plated contacts (0.15 μm)
Hold-down	Copper alloy/tin plating (2 μm)

■ Dimensions

XF2W-□□15-1A

XF2W-□□15-1AE

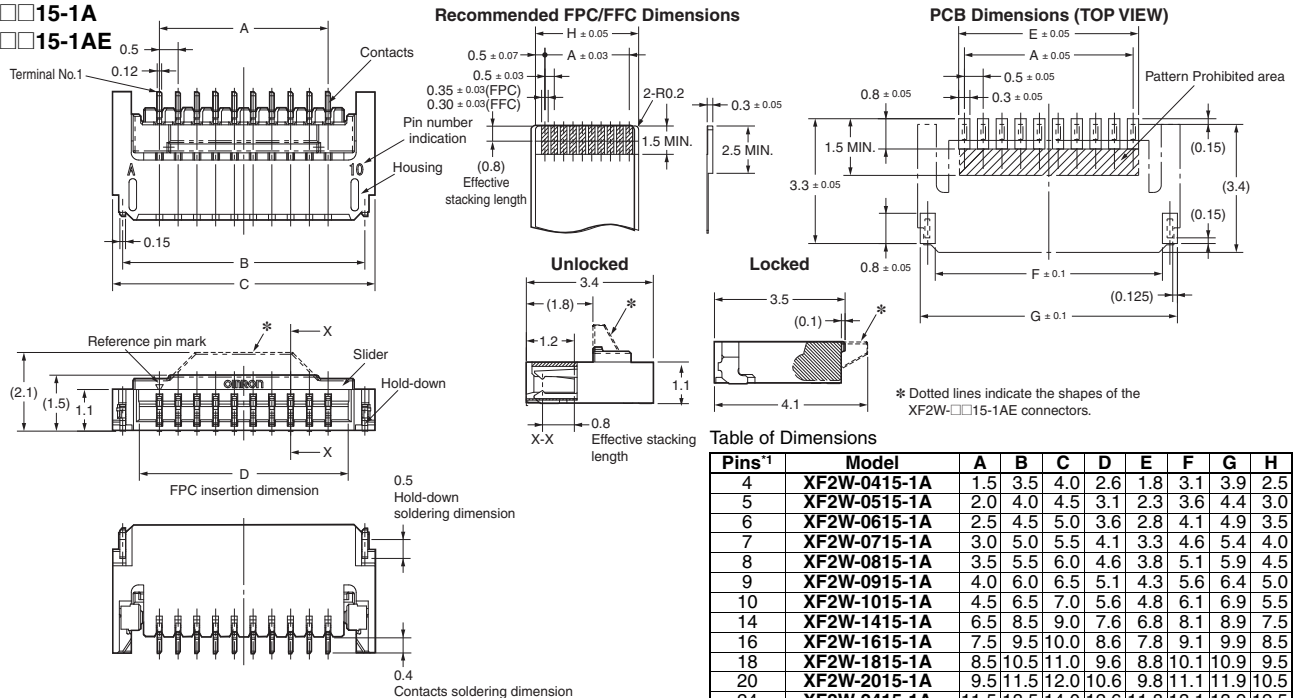

Table of Dimensions

Pins ^{*1}	Model	A	B	C	D	E	F	G	H
4	XF2W-0415-1A	1.5	3.5	4.0	2.6	1.8	3.1	3.9	2.5
5	XF2W-0515-1A	2.0	4.0	4.5	3.1	2.3	3.6	4.4	3.0
6	XF2W-0615-1A	2.5	4.5	5.0	3.6	2.8	4.1	4.9	3.5
7	XF2W-0715-1A	3.0	5.0	5.5	4.1	3.3	4.6	5.4	4.0
8	XF2W-0815-1A	3.5	5.5	6.0	4.6	3.8	5.1	5.9	4.5
9	XF2W-0915-1A	4.0	6.0	6.5	5.1	4.3	5.6	6.4	5.0
10	XF2W-1015-1A	4.5	6.5	7.0	5.6	4.8	6.1	6.9	5.5
14	XF2W-1415-1A	6.5	8.5	9.0	7.6	6.8	8.1	8.9	7.5
16	XF2W-1615-1A	7.5	9.5	10.0	8.6	7.8	9.1	9.9	8.5
18	XF2W-1815-1A	8.5	10.5	11.0	9.6	8.8	10.1	10.9	9.5
20	XF2W-2015-1A	9.5	11.5	12.0	10.6	9.8	11.1	11.9	10.5
24	XF2W-2415-1A	11.5	13.5	14.0	12.6	11.8	13.1	13.9	12.5
26	XF2W-2615-1A	12.5	14.5	15.0	13.6	12.8	14.1	14.9	13.5
40	XF2W-4015-1A	19.5	21.5	22.0	20.6	19.8	21.1	21.9	20.5
45	XF2W-4515-1AE	22.0	24.0	24.5	23.1	22.3	23.6	24.4	23.0
50	XF2W-5015-1AE	24.5	26.5	27.0	25.6	24.8	26.1	26.9	25.5
55	XF2W-5515-1AE	27.0	29.0	29.5	28.1	27.3	28.6	29.4	28.0
60	XF2W-6015-1AE	29.5	31.5	32.0	30.6	29.8	31.1	31.9	30.5
64	XF2W-6415-1AE	31.5	33.5	34.0	32.6	31.8	33.1	33.9	32.5

■ Ordering Information

2000pcs per reel

Pins ^{*1}	Model	Pins ^{*1}	Model	Pins ^{*1}	Model	Pins ^{*1}	Model	Quantity per reel (unit) ^{*2}
4	XF2W-0415-1A	9	XF2W-0915-1A	20	XF2W-2015-1A	50	XF2W-5015-1AE	2,000
5	XF2W-0515-1A	10	XF2W-1015-1A	24	XF2W-2415-1A	55	XF2W-5515-1AE	
6	XF2W-0615-1A	14	XF2W-1415-1A	26	XF2W-2615-1A	60	XF2W-6015-1AE	
7	XF2W-0715-1A	16	XF2W-1615-1A	40	XF2W-4015-1A	64	XF2W-6415-1AE	
8	XF2W-0815-1A	18	XF2W-1815-1A	45	XF2W-4515-1AE			

100pcs per reel

Pins ^{*1}	Model	Pins ^{*1}	Model	Pins ^{*1}	Model	Pins ^{*1}	Model	Quantity per reel (unit) ^{*2}
4	XF2W-0415-1A-R100	9	XF2W-0915-1A-R100	20	XF2W-2015-1A-R100	50	XF2W-5015-1AE-R100	100
5	XF2W-0515-1A-R100	10	XF2W-1015-1A-R100	24	XF2W-2415-1A-R100	55	XF2W-5515-1AE-R100	
6	XF2W-0615-1A-R100	14	XF2W-1415-1A-R100	26	XF2W-2615-1A-R100	60	XF2W-6015-1AE-R100	
7	XF2W-0715-1A-R100	16	XF2W-1615-1A-R100	40	XF2W-4015-1A-R100	64	XF2W-6415-1AE-R100	
8	XF2W-0815-1A-R100	18	XF2W-1815-1A-R100	45	XF2W-4515-1AE-R100			

*1. Please consult your OMRON representative for available pin count.

*2. Please order by integer multiple of the quantity per reel.

Rotary Backlock Connectors Provide Improved Insertion of FPC/FFC Cables and helps Confirm Proper Connection with Sure Lock Feel.

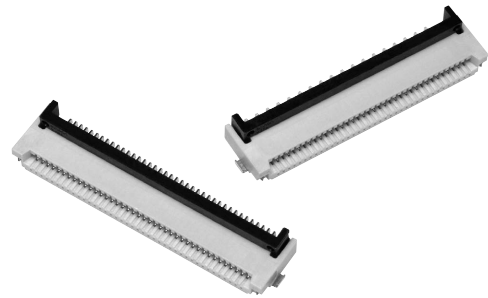

- Models available with 0.5-mm or 1.0-mm pitch.
- Models available with dual contacts or upper contacts.
(Models with upper contacts come only with a 0.5-mm pitch.)
- Models available with gold or tin plating.
(Tin plating is available only with models with dual contacts.)
- Models with 80 pins (multiple type) available with 0.5-mm pitch.
- Applicable FPC/FFC thickness of 0.3 mm.
- Halogen Free (*)

* OMRON uses the following standard to determine halogen-free construction: 900 ppm max. for Br, 900 ppm max. for Cl, and 1,500 ppm max. for Br+Cl.

RoHS compliant

■ Ratings and Specifications

Rated current	0.5 A AC/DC
Rated voltage	50 V AC/DC
Contact resistance	50 mΩ max. (at 20 mV DC max., 100 mA max.)
Insulation resistance	100 MΩ min. (at 250 V DC)
Dielectric strength	250 V AC for 1 min. (leakage current: 1 mA max.)
Insertion durability	Gold plating: 20 times Tin plating: 10 times
Ambient operating temperature	-30 to 85 °C (With no icing or condensation)

■ Materials and Finish

Model	Dual Contact Models		Upper-contact Models
Item	Gold plating	Tin plating	Gold plating
Housing	LCP resin (UL94 V-0)/natural		LCP resin (UL94 V-0)/gray
Slider	LCP resin (UL94 V-0)/black		
Contacts	Spring copper alloy/nickel substrate (1.5 μm)		
	Gold-plated contacts (flash)	Tin-plated contacts (1 μm)	Gold-plated contacts (flash)
Hold-down	Copper alloy/tin plating (1 μm)		

■ Model Number Legend (Refer to *Models* on pages 16 and 17 for the product lineup.)

XF3M - 5-1 -

(1) (2) (3)(4) (5)(6)(7) (8)

(1) Classification in Series

3M : 0.5 mm pitch
3M(1) : 1.0 mm pitch

(3) Signal Contact Arrangement

1 : Dual Contact
2 : Upper Contact

(5) Applicable FPC/FFC thickness

1 : 0.3mm

(7) Slider

Blank : Standard
E : Easy-operation connector

(2) Number of Signal Contact Pins

(4) Terminal Shape

5 : SMT terminals (side entry)

(6) Plating

B : Au flash
D : Sn

(8) Packing unit

R100 : 100pcs

XF3M 0.5-mm pitch model

■ Dimensions

XF3M-□□15-1B
 XF3M-□□15-1BE
 XF3M-□□15-1D
 XF3M-□□25-1B

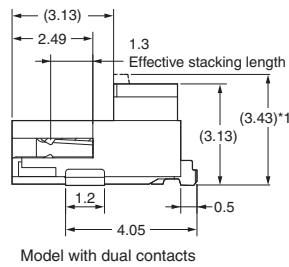
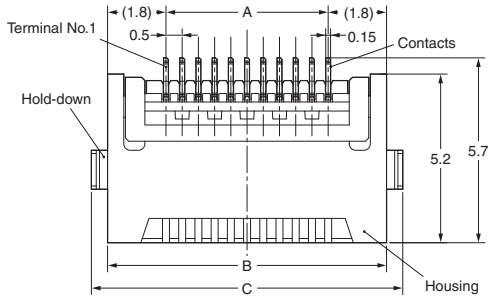

Model with dual contacts
Unlocked

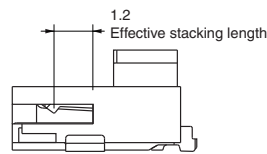
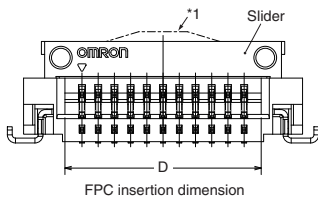

Model with single-sided contacts (upper contacts) *2
Unlocked

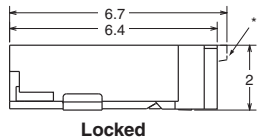

Locked

PCB Dimensions (TOP VIEW)

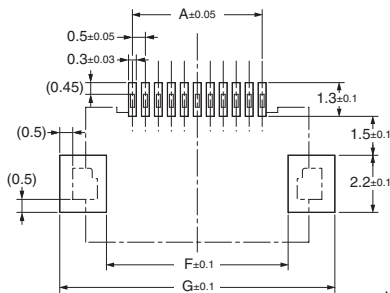

Recommended FPC/FFC Dimensions

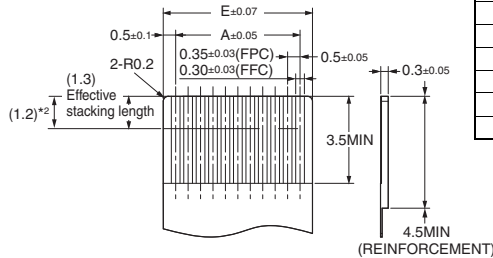

- *1. Dotted lines indicate the shape and dimensions of the XF3M-8015-1BE Connectors.
- *2. For the XF3M-□□25-1B Connectors.

Table of Dimension

Pins*1	A	B	C	D	E	F	G
6	2.5	6.1	7.1	3.55	3.5	4.5	8.1
7	3.0	6.6	7.6	4.05	4.0	5.0	8.6
8	3.5	7.1	8.1	4.55	4.5	5.5	9.1
9	4.0	7.6	8.6	5.05	5.0	6.0	9.6
10	4.5	8.1	9.1	5.55	5.5	6.5	10.1
11	5.0	8.6	9.6	6.05	6.0	7.0	10.6
12	5.5	9.1	10.1	6.55	6.5	7.5	11.1
13	6.0	9.6	10.6	7.05	7.0	8.0	11.6
14	6.5	10.1	11.1	7.55	7.5	8.5	12.1
15	7.0	10.6	11.6	8.05	8.0	9.0	12.6
16	7.5	11.1	12.1	8.55	8.5	9.5	13.1
17	8.0	11.6	12.6	9.05	9.0	10.0	13.6
18	8.5	12.1	13.1	9.55	9.5	10.5	14.1
19	9.0	12.6	13.6	10.05	10.0	11.0	14.6
20	9.5	13.1	14.1	10.55	10.5	11.5	15.1
21	10.0	13.6	14.6	11.05	11.0	12.0	15.6
22	10.5	14.1	15.1	11.55	11.5	12.5	16.1
23	11.0	14.6	15.6	12.05	12.0	13.0	16.6
24	11.5	15.1	16.1	12.55	12.5	13.5	17.1
25	12.0	15.6	16.6	13.05	13.0	14.0	17.6
26	12.5	16.1	17.1	13.55	13.5	14.5	18.1
28	13.5	17.1	18.1	14.55	14.5	15.5	19.1
30	14.5	18.1	19.1	15.55	15.5	16.5	20.1
31	15.0	18.6	19.6	16.05	16.0	17.0	20.6
32	15.5	19.1	20.1	16.55	16.5	17.5	21.1
33	16.0	19.6	20.6	17.05	17.0	18.0	21.6
34	16.5	20.1	21.1	17.55	17.5	18.5	22.1
35	17.0	20.6	21.6	18.05	18.0	19.0	22.6
36	17.5	21.1	22.1	18.55	18.5	19.5	23.1
37	18.0	21.6	22.6	19.05	19.0	20.0	23.6
40	19.5	23.1	24.1	20.55	20.5	21.5	25.1
41	20.0	23.6	24.6	21.05	21.0	22.0	25.6
45	22.0	25.6	26.6	23.05	23.0	24.0	27.6
50	24.5	28.1	29.1	25.55	25.5	26.5	30.1
53	26.0	29.6	30.6	27.05	27.0	28.0	31.6
60	29.5	33.1	34.1	30.55	30.5	31.5	35.1
80	39.5	43.1	44.1	40.55	40.5	41.5	45.1

Ordering Information

● Dual Contact Models - Gold plating

1500pcs per reel

Pins ^{*1}	Model	Pins ^{*1}	Model	Pins ^{*1}	Model	Pins ^{*1}	Model	Quantity per reel (unit) ^{*2}
6	XF3M-0615-1B	16	XF3M-1615-1B	26	XF3M-2615-1B	37	XF3M-3715-1B	1,500
7	XF3M-0715-1B	17	XF3M-1715-1B	(28)	XF3M-2815-1B	40	XF3M-4015-1B	
8	XF3M-0815-1B	18	XF3M-1815-1B	29	XF3M-2915-1B	41	XF3M-4115-1B	
9	XF3M-0915-1B	19	XF3M-1915-1B	30	XF3M-3015-1B	45	XF3M-4515-1B	
10	XF3M-1015-1B	20	XF3M-2015-1B	31	XF3M-3115-1B	50	XF3M-5015-1B	
11	XF3M-1115-1B	21	XF3M-2115-1B	(32)	XF3M-3215-1B	(53)	XF3M-5315-1B	
12	XF3M-1215-1B	22	XF3M-2215-1B	33	XF3M-3315-1B	60	XF3M-6015-1B	
13	XF3M-1315-1B	23	XF3M-2315-1B	34	XF3M-3415-1B			
14	XF3M-1415-1B	24	XF3M-2415-1B	(35)	XF3M-3515-1B			
15	XF3M-1515-1B	25	XF3M-2515-1B	36	XF3M-3615-1B			

1000pcs per reel

Pins ^{*1}	Model
80	XF3M-8015-1BE

100pcs per reel

Pins ^{*1}	Model	Pins ^{*1}	Model	Pins ^{*1}	Model	Pins ^{*1}	Model	Quantity per reel (unit) ^{*2}
6	XF3M-0615-1B-R100	16	XF3M-1615-1B-R100	26	XF3M-2615-1B-R100	37	XF3M-3715-1B-R100	100
7	XF3M-0715-1B-R100	17	XF3M-1715-1B-R100	(28)	XF3M-2815-1B-R100	40	XF3M-4015-1B-R100	
8	XF3M-0815-1B-R100	18	XF3M-1815-1B-R100	29	XF3M-2915-1B-R100	41	XF3M-4115-1B-R100	
9	XF3M-0915-1B-R100	19	XF3M-1915-1B-R100	30	XF3M-3015-1B-R100	45	XF3M-4515-1B-R100	
10	XF3M-1015-1B-R100	20	XF3M-2015-1B-R100	31	XF3M-3115-1B-R100	50	XF3M-5015-1B-R100	
11	XF3M-1115-1B-R100	21	XF3M-2115-1B-R100	(32)	XF3M-3215-1B-R100	(53)	XF3M-5315-1B-R100	
12	XF3M-1215-1B-R100	22	XF3M-2215-1B-R100	33	XF3M-3315-1B-R100	60	XF3M-6015-1B-R100	
13	XF3M-1315-1B-R100	23	XF3M-2315-1B-R100	34	XF3M-3415-1B-R100	80	XF3M-8015-1BE-R100	
14	XF3M-1415-1B-R100	24	XF3M-2415-1B-R100	(35)	XF3M-3515-1B-R100			
15	XF3M-1515-1B-R100	25	XF3M-2515-1B-R100	36	XF3M-3615-1B-R100			

● Dual Contact Models - Tin plating

1500pcs per reel

Pins ^{*1}	Model	Pins ^{*1}	Model	Pins ^{*1}	Model	Quantity per reel (unit) ^{*2}
(6)	XF3M-0615-1D	(11)	XF3M-1115-1D	(16)	XF3M-1615-1D	1,500
(7)	XF3M-0715-1D	(12)	XF3M-1215-1D	(17)	XF3M-1715-1D	
(8)	XF3M-0815-1D	(13)	XF3M-1315-1D	(18)	XF3M-1815-1D	
(9)	XF3M-0915-1D	(14)	XF3M-1415-1D	(19)	XF3M-1915-1D	
(10)	XF3M-1015-1D	(15)	XF3M-1515-1D	(20)	XF3M-2015-1D	

100pcs per reel

Pins ^{*1}	Model	Pins ^{*1}	Model	Pins ^{*1}	Model	Quantity per reel (unit) ^{*2}
(6)	XF3M-0615-1D-R100	(11)	XF3M-1115-1D-R100	(16)	XF3M-1615-1D-R100	100
(7)	XF3M-0715-1D-R100	(12)	XF3M-1215-1D-R100	(17)	XF3M-1715-1D-R100	
(8)	XF3M-0815-1D-R100	(13)	XF3M-1315-1D-R100	(18)	XF3M-1815-1D-R100	
(9)	XF3M-0915-1D-R100	(14)	XF3M-1415-1D-R100	(19)	XF3M-1915-1D-R100	
(10)	XF3M-1015-1D-R100	(15)	XF3M-1515-1D-R100	(20)	XF3M-2015-1D-R100	

● Upper-contact Models - Gold plating

1500pcs per reel

Pins ^{*1}	Model	Pins ^{*1}	Model	Pins ^{*1}	Model	Quantity per reel (unit) ^{*2}
(6)	XF3M-0625-1B	12	XF3M-1225-1B	18	XF3M-1825-1B	1,500
7	XF3M-0725-1B	(13)	XF3M-1325-1B	(19)	XF3M-1925-1B	
8	XF3M-0825-1B	14	XF3M-1425-1B	(20)	XF3M-2025-1B	
9	XF3M-0925-1B	(15)	XF3M-1525-1B	22	XF3M-2225-1B	
(10)	XF3M-1025-1B	16	XF3M-1625-1B	24	XF3M-2425-1B	
(11)	XF3M-1125-1B	(17)	XF3M-1725-1B	40	XF3M-4025-1B	

100pcs per reel

Pins ^{*1}	Model	Pins ^{*1}	Model	Pins ^{*1}	Model	Quantity per reel (unit) ^{*2}
(6)	XF3M-0625-1B-R100	(12)	XF3M-1225-1B-R100	(18)	XF3M-1825-1B-R100	100
(7)	XF3M-0725-1B-R100	(13)	XF3M-1325-1B-R100	(19)	XF3M-1925-1B-R100	
(8)	XF3M-0825-1B-R100	(14)	XF3M-1425-1B-R100	(20)	XF3M-2025-1B-R100	
(9)	XF3M-0925-1B-R100	(15)	XF3M-1525-1B-R100	(22)	XF3M-2225-1B-R100	
(10)	XF3M-1025-1B-R100	(16)	XF3M-1625-1B-R100	(24)	XF3M-2425-1B-R100	
(11)	XF3M-1125-1B-R100	(17)	XF3M-1725-1B-R100	(40)	XF3M-4025-1B-R100	

*1. Please consult your OMRON representative for available pin count.

Please consult your OMRON representative for the marketing dates for pin counts in parentheses.

*2. Please order by integer multiple of the quantity per reel.

XF3M(1) 1.0-mm pitch model

■ Dimensions

XF3M(1)-□□15-1B
XF3M(1)-□□15-1D

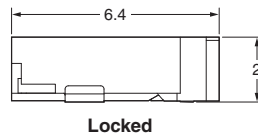
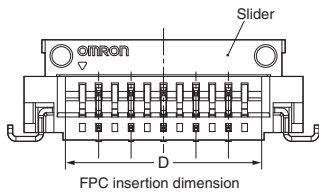
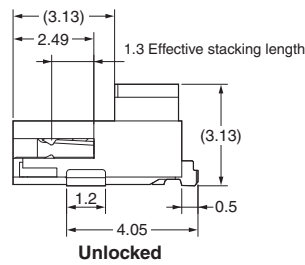
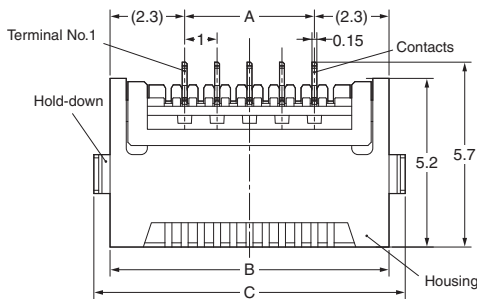

PCB Dimensions (TOP VIEW)

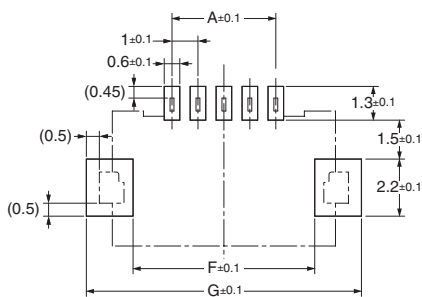

Recommended FPC/FFC Dimensions

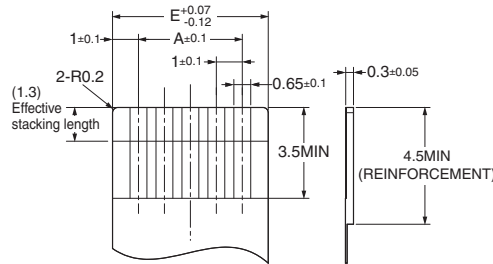

Table of Dimensions

Pins*1	A	B	C	D	E	F	G
4	3.0	7.6	8.6	5.05	5.0	6.0	9.6
5	4.0	8.6	9.6	6.05	6.0	7.0	10.6
6	5.0	9.6	10.6	7.05	7.0	8.0	11.6
7	6.0	10.6	11.6	8.05	8.0	9.0	12.6
8	7.0	11.6	12.6	9.05	9.0	10.0	13.6
9	8.0	12.6	13.6	10.05	10.0	11.0	14.6
10	9.0	13.6	14.6	11.05	11.0	12.0	15.6
11	10.0	14.6	15.6	12.05	12.0	13.0	16.6
12	11.0	15.6	16.6	13.05	13.0	14.0	17.6
15	14.0	18.6	19.6	16.05	16.0	17.0	20.6
16	15.0	19.6	20.6	17.05	17.0	18.0	21.6
17	16.0	20.6	21.6	18.05	18.0	19.0	22.6
18	17.0	21.6	22.6	19.05	19.0	20.0	23.6
20	19.0	23.6	24.6	21.05	21.0	22.0	25.6
22	21.0	25.6	26.6	23.05	23.0	24.0	27.6
26	25.0	29.6	30.6	27.05	27.0	28.0	31.6
30	29.0	33.6	34.6	31.05	31.0	32.0	35.6

■ Ordering Information

● Dual Contact Models - Gold plating

1500pcs per reel

Pins*1	Model	Pins*1	Model	Pins*1	Model	Pins*1	Model	Quantity per reel (unit) *2
4	XF3M(1)-0415-1B	9	XF3M(1)-0915-1B	15	XF3M(1)-1515-1B	22	XF3M(1)-2215-1B	1,500
5	XF3M(1)-0515-1B	10	XF3M(1)-1015-1B	16	XF3M(1)-1615-1B	26	XF3M(1)-2615-1B	
6	XF3M(1)-0615-1B	11	XF3M(1)-1115-1B	(17)	XF3M(1)-1715-1B	30	XF3M(1)-3015-1B	
7	XF3M(1)-0715-1B	12	XF3M(1)-1215-1B	18	XF3M(1)-1815-1B			
8	XF3M(1)-0815-1B	14	XF3M(1)-1415-1B	20	XF3M(1)-2015-1B			

100pcs per reel

Pins*1	Model	Pins*1	Model	Pins*1	Model	Pins*1	Model	Quantity per reel (unit) *2
4	XF3M(1)-0415-1B-R100	9	XF3M(1)-0915-1B-R100	15	XF3M(1)-1515-1B-R100	22	XF3M(1)-2215-1B-R100	100
5	XF3M(1)-0515-1B-R100	10	XF3M(1)-1015-1B-R100	16	XF3M(1)-1615-1B-R100	26	XF3M(1)-2615-1B-R100	
6	XF3M(1)-0615-1B-R100	11	XF3M(1)-1115-1B-R100	(17)	XF3M(1)-1715-1B-R100	30	XF3M(1)-3015-1B-R100	
7	XF3M(1)-0715-1B-R100	12	XF3M(1)-1215-1B-R100	18	XF3M(1)-1815-1B-R100			
8	XF3M(1)-0815-1B-R100	14	XF3M(1)-1415-1B-R100	20	XF3M(1)-2015-1B-R100			

● Dual Contact Models - Tin plating

1500pcs per reel

Pins*1	Model	Pins*1	Model	Pins*1	Model	Quantity per reel (unit) *2
(4)	XF3M(1)-0415-1D	(9)	XF3M(1)-0915-1D	(16)	XF3M(1)-1615-1D	1,500
(5)	XF3M(1)-0515-1D	10	XF3M(1)-1015-1D	(17)	XF3M(1)-1715-1D	
(6)	XF3M(1)-0615-1D	(11)	XF3M(1)-1115-1D	(18)	XF3M(1)-1815-1D	
(7)	XF3M(1)-0715-1D	(12)	XF3M(1)-1215-1D	(20)	XF3M(1)-2015-1D	
(8)	XF3M(1)-0815-1D	(15)	XF3M(1)-1515-1D			

100pcs per reel

Pins*1	Model	Pins*1	Model	Pins*1	Model	Quantity per reel (unit) *2
(4)	XF3M(1)-0415-1D-R100	(9)	XF3M(1)-0915-1D-R100	(16)	XF3M(1)-1615-1D-R100	100
(5)	XF3M(1)-0515-1D-R100	10	XF3M(1)-1015-1D-R100	(17)	XF3M(1)-1715-1D-R100	
(6)	XF3M(1)-0615-1D-R100	(11)	XF3M(1)-1115-1D-R100	(18)	XF3M(1)-1815-1D-R100	
(7)	XF3M(1)-0715-1D-R100	(12)	XF3M(1)-1215-1D-R100	(20)	XF3M(1)-2015-1D-R100	
(8)	XF3M(1)-0815-1D-R100	(15)	XF3M(1)-1515-1D-R100			

*1. Please consult your OMRON representative for available pin count.
Please consult your OMRON representative for the marketing dates for pin counts in parentheses.
*2. Please order by integer multiple of the quantity per reel.

XF2M

Rotary Backlock Connector (0.5-mm Pitch, Dual Contact)

For FPC/FFC

High-reliability rotary-lock and Superior Work Efficiency.

- Dual contact reduces the number of parts.
- Applicable FPC/FFC thickness of 0.3 mm (Gold plating type).
- Halogen Free (*)

* OMRON uses the following standard to determine halogen-free construction: 900 ppm max. for Br, 900 ppm max. for Cl, and 1,500 ppm max. for Br+Cl.

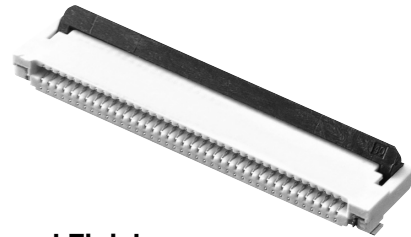

RoHS compliant

■ Ratings and Specifications

Rated current	0.5 A AC/DC
Rated voltage	50 V AC/DC
Contact resistance	50 mΩ max. (at 20 mV DC max., 100 mA max.)
Insulation resistance	100 MΩ min. (at 250 V DC)
Dielectric strength	250 V AC for 1 min. (leakage current: 1 mA max.)
Insertion durability	20 times
Ambient operating temperature	-30 to 85 °C (With no icing or condensation)

■ Materials and Finish

Housing	LCP resin (UL94 V-0)/natural
Slider	LCP resin (UL94 V-0)/black
Contacts	Spring copper alloy/nickel substrate (2 μm) Gold-plated contacts (0.15 μm)
Hold-down	Copper alloy/tin plating (1.5 μm)

■ Dimensions

XF2M-□□15-1A
XF2M-□□15-1AH

Table of Dimensions

Pins ¹	Model	A	B	C	D	E	F	G
6	XF2M-0615-1A	2.5	3.6	6.5	7.1	5.1	4.1	7.5
8	XF2M-0815-1A	3.5	4.6	7.5	8.1	6.1	5.1	8.5
10	XF2M-1015-1A	4.5	5.6	8.5	9.1	7.1	6.1	9.5
12	XF2M-1215-1A	5.5	6.6	9.5	10.1	8.1	7.1	10.5
14	XF2M-1415-1A	6.5	7.6	10.5	11.1	9.1	8.1	11.5
18	XF2M-1815-1A	8.5	9.6	12.5	13.1	11.1	10.1	13.5
20	XF2M-2015-1A	9.5	10.6	13.5	14.1	12.1	11.1	14.5
22	XF2M-2215-1A	10.5	11.6	14.5	15.1	13.1	12.1	15.5
24	XF2M-2415-1A	11.5	12.6	15.5	16.1	14.1	13.1	16.5
26	XF2M-2615-1A	12.5	13.6	16.5	17.1	15.1	14.1	17.5
30	XF2M-3015-1A	14.5	15.6	18.5	19.1	17.1	16.1	19.5
32	XF2M-3215-1A	15.5	16.6	19.5	20.1	18.1	17.1	20.5
33	XF2M-3315-1A	16.0	17.1	20.0	20.6	18.6	17.6	21.0
34	XF2M-3415-1A	16.5	17.6	20.5	21.1	19.1	18.1	21.5
35	XF2M-3515-1A	17.0	18.1	21.0	21.6	19.6	18.6	22.0
36	XF2M-3615-1A	17.5	18.6	21.5	22.1	20.1	19.1	22.5
38	XF2M-3815-1A	18.5	19.6	22.5	23.1	21.1	20.1	23.5
40	XF2M-4015-1A	19.5	20.6	23.5	24.1	22.1	21.1	24.5
42	XF2M-4215-1A	20.5	21.6	24.5	25.1	23.1	22.1	25.5
45	XF2M-4515-1A	22.0	23.1	26.0	26.6	24.6	23.6	27.0
50	XF2M-5015-1A	24.5	25.6	28.5	29.1	27.1	26.1	29.5
54	XF2M-5415-1AH	26.5	27.6	30.5	31.1	29.1	28.1	31.5
55	XF2M-5515-1AH	27.0	28.1	31.0	31.6	29.6	28.6	32.0
60	XF2M-6015-1AH	29.5	30.6	33.5	34.1	32.1	31.1	34.5

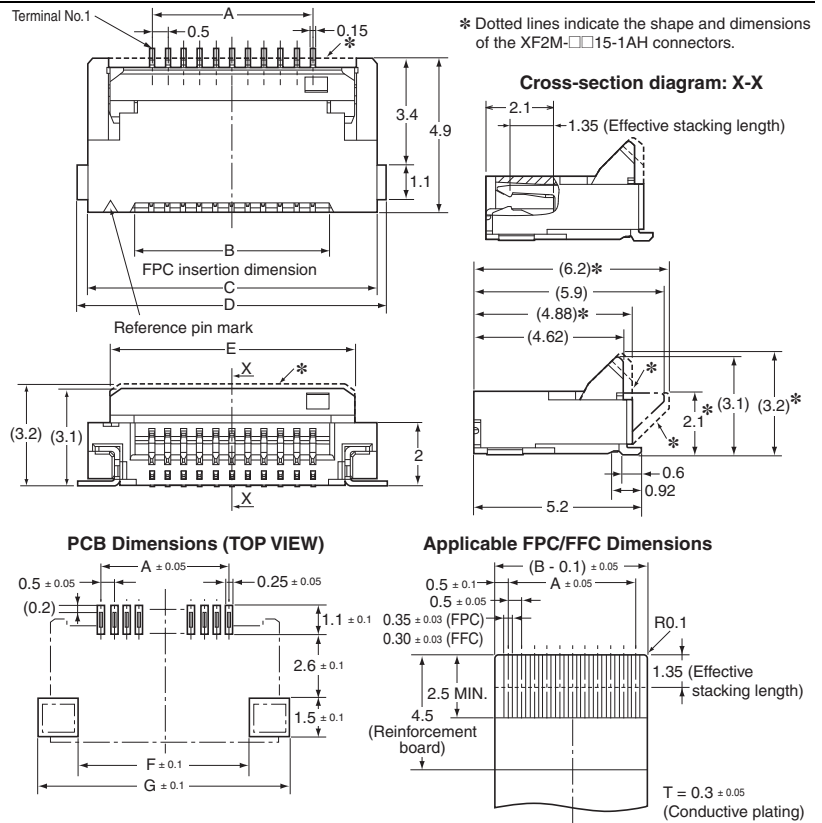

■ Ordering Information

1500pcs per reel

Pins ¹	Model	Pins ¹	Model	Pins ¹	Model	Pins ¹	Model	Quantity per reel (unit) ²
6	XF2M-0615-1A	22	XF2M-2215-1A	35	XF2M-3515-1A	54	XF2M-5415-1AH	1,500
8	XF2M-0815-1A	24	XF2M-2415-1A	36	XF2M-3615-1A	55	XF2M-5515-1AH	
10	XF2M-1015-1A	26	XF2M-2615-1A	38	XF2M-3815-1A	60	XF2M-6015-1AH	
12	XF2M-1215-1A	30	XF2M-3015-1A	40	XF2M-4015-1A			
14	XF2M-1415-1A	32	XF2M-3215-1A	42	XF2M-4215-1A			
18	XF2M-1815-1A	33	XF2M-3315-1A	45	XF2M-4515-1A			
20	XF2M-2015-1A	34	XF2M-3415-1A	50	XF2M-5015-1A			

100pcs per reel

Pins ¹	Model	Pins ¹	Model	Pins ¹	Model	Pins ¹	Model	Quantity per reel (unit) ²
6	XF2M-0615-1A-R100	22	XF2M-2215-1A-R100	35	XF2M-3515-1A-R100	54	XF2M-5415-1AH-R100	100
8	XF2M-0815-1A-R100	24	XF2M-2415-1A-R100	36	XF2M-3615-1A-R100	55	XF2M-5515-1AH-R100	
10	XF2M-1015-1A-R100	26	XF2M-2615-1A-R100	38	XF2M-3815-1A-R100	60	XF2M-6015-1AH-R100	
12	XF2M-1215-1A-R100	30	XF2M-3015-1A-R100	40	XF2M-4015-1A-R100			
14	XF2M-1415-1A-R100	32	XF2M-3215-1A-R100	42	XF2M-4215-1A-R100			
18	XF2M-1815-1A-R100	33	XF2M-3315-1A-R100	45	XF2M-4515-1A-R100			
20	XF2M-2015-1A-R100	34	XF2M-3415-1A-R100	50	XF2M-5015-1A-R100			

*1. Please consult your OMRON representative for available pin count.

*2. Please order by integer multiple of the quantity per reel.

XF2L

ZIF Slide-locking Connector (0.5-mm Pitch)

For FPC

Greater Freedom in Board Design with a Bottom Wall and the Smallest On-board Area in the Industry

- Smallest on-board area and volume in the industry.
- Low on-board height of only 1.2 mm.
- Highest board design surface efficiency in the industry with a bottom wall preventing terminal exposure.
- Construction with secure slider locking mechanism.
- Applicable FPC thickness of 0.3 mm (Gold plating type).
- Halogen Free (*)

* OMRON uses the following standard to determine halogen-free construction: 900 ppm max. for Br, 900 ppm max. for Cl, and 1,500 ppm max. for Br+Cl.



RoHS compliant

■ Ratings and Specifications

Rated current	0.5 A AC/DC
Rated voltage	50 V AC/DC
Contact resistance	30 mΩ max. (at 20 mV DC max., 100 mA max.)
Insulation resistance	100 MΩ min. (at 250 V DC)
Dielectric strength	250 V AC for 1 min. (leakage current: 1 mA max.)
Insertion durability	20 times
Ambient operating temperature	-30 to 85 °C (With no icing or condensation)

■ Materials and Finish

Item	Model	XF2L (Upper-contact Models)	XF2L (Lower-contact Models)
Housing		LCP resin (UL94 V-0)/natural	
Slider		LCP resin (UL94 V-0)/black	LCP resin (UL94 V-0)/brown
Contacts		Spring copper alloy/nickel substrate (2 μm) Gold-plated contacts (0.15 μm)	
Hold-down		Copper alloy/tin plating (1.5 μm)	

■ Dimensions

XF2L-□□□5-1A

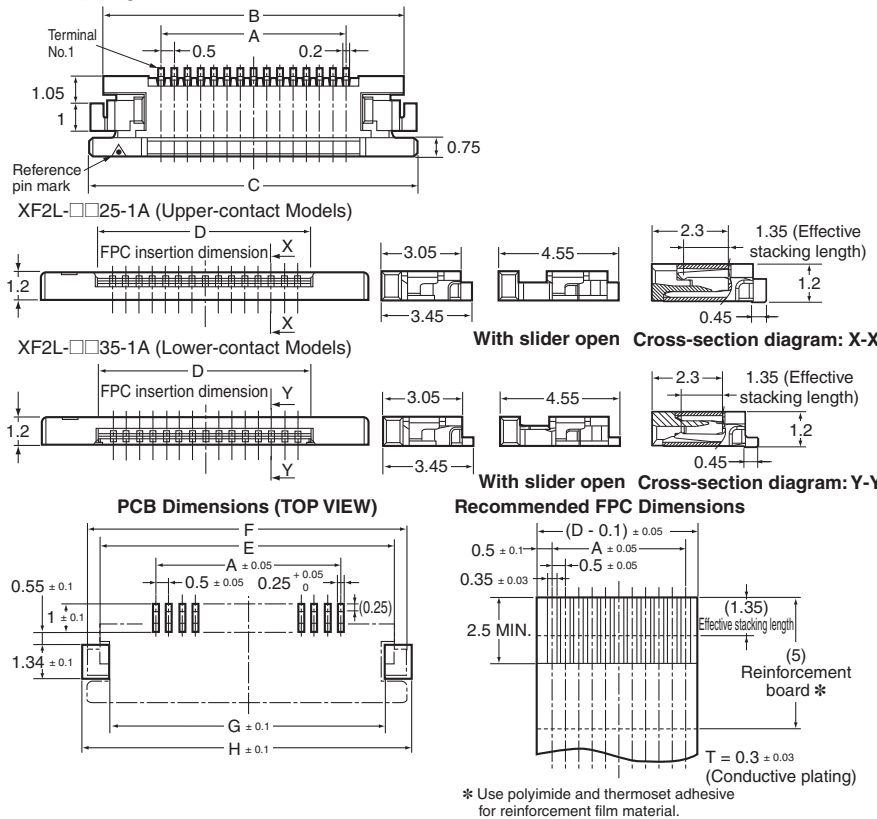

■ Ordering Information

Pins ^{*1}	List of Models	Model	Pins ^{*1}	List of Models	Model	Pins ^{*1}	List of Models	Model	Quantity per reel (unit) ^{*2}
4	Upper Contact	XF2L-0425-1A	10	Upper Contact	XF2L-1025-1A	19	Lower contact	XF2L-1935-1A	3,000
5	Lower contact	XF2L-0535-1A		Lower contact	XF2L-1035-1A	20	Lower contact	XF2L-2035-1A	
6	Upper Contact	XF2L-0625-1A	12	Upper Contact	XF2L-1225-1A	21	Upper Contact	XF2L-2125-1A	
	Lower contact	XF2L-0635-1A		Lower contact	XF2L-1235-1A	22	Lower contact	XF2L-2235-1A	
7	Upper Contact	XF2L-0725-1A	13	Upper Contact	XF2L-1325-1A	24	Lower contact	XF2L-2435-1A	
	Lower contact	XF2L-0735-1A		Lower contact	XF2L-1335-1A	26	Upper Contact	XF2L-2625-1A	
8	Upper Contact	XF2L-0825-1A	15	Lower contact	XF2L-1535-1A	30	Upper Contact	XF2L-3025-1A	
	Lower contact	XF2L-0835-1A		Upper Contact	XF2L-1825-1A		Lower contact	XF2L-3035-1A	
9	Upper Contact	XF2L-0925-1A	18	Lower contact	XF2L-1835-1A	-	-	-	

*1. Please consult your OMRON representative for available pin count.

*2. Please order by integer multiple of the quantity per reel.

XF2J

ZIF Slide-locking Connector (0.5-mm Pitch)

For FPC/FFC

Top-entry ZIF Connector.

- Low on-board height of only 4.15 mm.
- Correspond for auto-mounting, secured the pick-and-place on top of the connector.
- Models with reverse terminal type also available.
- Applicable FPC/FFC thickness of 0.3 mm (Gold plating type).

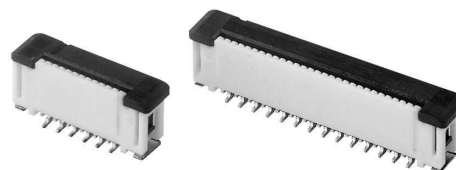

RoHS compliant

■ Ratings and Specifications

Rated current	0.5 A AC/DC
Rated voltage	50 V AC/DC
Contact resistance	30 mΩ max. (at 20 mV DC max., 100 mA max.)
Insulation resistance	100 MΩ min. (at 250 V DC)
Dielectric strength	250 V AC for 1 min. (leakage current: 1 mA max.)
Insertion durability	30 times
Ambient operating temperature	-30 to 85 °C (With no icing or condensation)

■ Materials and Finish

Housing	PA46 resin (UL94 V-0)/natural
Slider	LCP resin (UL94 V-0)/black
Contacts	Spring copper alloy/nickel substrate (2 μm), Gold-plated contacts (0.15 μm)
Hold-down	Copper alloy/tin plating (1.5 μm)

■ Dimensions

XF2J-□□24-1□A

Recommended FPC/FFC Dimensions

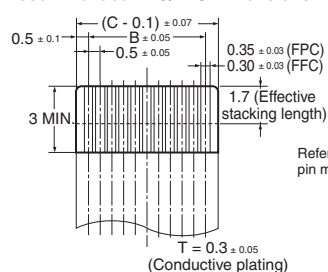

(Standard terminal type)

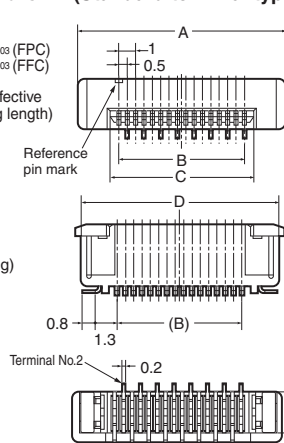

(Reverse terminal type)

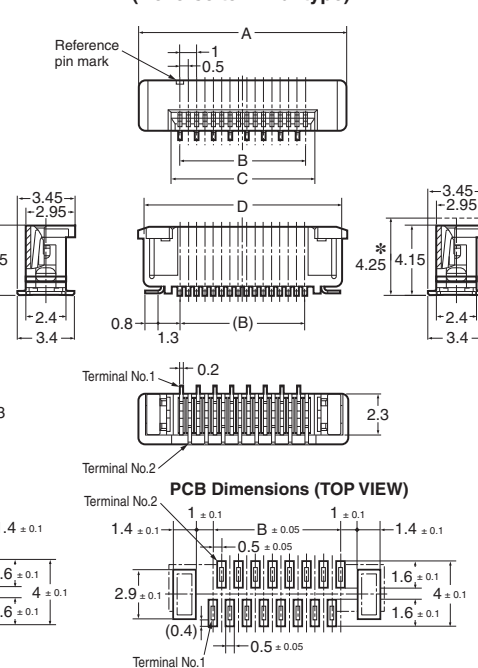

Table of Dimensions

Pins ¹	Model		A	B	C	D
	Standard terminal type	Reverse terminal type				
6	XF2J-0624-11A	XF2J-0624-12A	7.5	2.5	3.6	6.9
8	XF2J-0824-11A	XF2J-0824-12A	8.5	3.5	4.6	7.9
10	XF2J-1024-11A	XF2J-1024-12A	9.5	4.5	5.6	8.9
12	XF2J-1224-11A	XF2J-1224-12A	10.5	5.5	6.6	9.9
14	XF2J-1424-11A	-	11.5	6.5	7.6	10.9
16	XF2J-1624-11A	XF2J-1624-12A	12.5	7.5	8.6	11.9
18	XF2J-1824-11A	XF2J-1824-12A	13.5	8.5	9.6	12.9
20	XF2J-2024-11A	XF2J-2024-12A	14.5	9.5	10.6	13.9
22	XF2J-2224-11A	XF2J-2224-12A	15.5	10.5	11.6	14.9
24	XF2J-2424-11A	XF2J-2424-12A	16.5	11.5	12.6	15.9
26	XF2J-2624-11A	-	17.5	12.5	13.6	16.9
28	XF2J-2824-11A	-	18.5	13.5	14.6	17.9
30	XF2J-3024-11A	-	19.5	14.5	15.6	18.9
40	-	XF2J-4024-12A	25.1	19.5	20.6	24.3

* Dotted lines indicate the shape and dimensions of the XF2J-4024-12A connectors.

■ Ordering Information

1000pcs per reel

Pins ¹	Model		Pins ¹	Model		Pins ¹	Model		Quantity per reel (unit) ²
	Standard terminal type	Reverse terminal type		Standard terminal type	Reverse terminal type		Standard terminal type	Reverse terminal type	
6	XF2J-0624-11A	XF2J-0624-12A	16	XF2J-1624-11A	XF2J-1624-12A	26	XF2J-2624-11A	-	1,000
8	XF2J-0824-11A	XF2J-0824-12A	18	XF2J-1824-11A	XF2J-1824-12A	28	XF2J-2824-11A	-	
10	XF2J-1024-11A	XF2J-1024-12A	20	XF2J-2024-11A	XF2J-2024-12A	30	XF2J-3024-11A	-	
12	XF2J-1224-11A	XF2J-1224-12A	22	XF2J-2224-11A	XF2J-2224-12A	40	-	XF2J-4024-12A	
14	XF2J-1424-11A	-	24	XF2J-2424-11A	XF2J-2424-12A				

100pcs per reel

Pins ¹	Model		Pins ¹	Model		Pins ¹	Model		Quantity per reel (unit) ²
	Standard terminal type	Reverse terminal type		Standard terminal type	Reverse terminal type		Standard terminal type	Reverse terminal type	
6	XF2J-0624-11A-R100	XF2J-0624-12A-R100	16	XF2J-1624-11A-R100	XF2J-1624-12A-R100	26	XF2J-2624-11A-R100	-	100
8	XF2J-0824-11A-R100	XF2J-0824-12A-R100	18	XF2J-1824-11A-R100	XF2J-1824-12A-R100	28	XF2J-2824-11A-R100	-	
10	XF2J-1024-11A-R100	XF2J-1024-12A-R100	20	XF2J-2024-11A-R100	XF2J-2024-12A-R100	30	XF2J-3024-11A-R100	-	
12	XF2J-1224-11A-R100	XF2J-1224-12A-R100	22	XF2J-2224-11A-R100	XF2J-2224-12A-R100	40	-	XF2J-4024-12A-R100	
14	XF2J-1424-11A-R100	-	24	XF2J-2424-11A-R100	XF2J-2424-12A-R100				

*1. Please consult your OMRON representative for available pin count.

*2. Please order by integer multiple of the quantity per reel.

Common Precautions for XF Connectors

■ Safety Precautions

Precautions for Correct Use

For All Models

● For Operating

- Make sure that the FPC has been inserted correctly.
If the FPC is inserted incorrectly from the customer's design specification, the pin number will not match and it may damage the contacts or cause malfunction of the equipment.

- Insert the FPC fully to the back of the connector.

Not doing so may cause a loss of contact reliability.

- Do not lock or unlock the slider with excessive force.

The connector may be damaged, and cause contact failure.

- Do not use the connector of which the slider has once come off.

- When inserting and drawing out the FPC, make sure that the slider has been unlocked first.

Using the FPC in the following ways may damage the FPC, change the shape of the contacts, or result in contact failure.

(1) Drawing out the FPC when the slider is still locked.

(2) Drawing out the FPC by pulling it up and down or from left to right or twisting it sideways.

● For Designing

- When mounting the connector to the FPC, design the FPC so that extreme peel force should not be applied directly on to the connector.

If the FPC bends near the connector, or if the FPC is used with extreme peel force directly on to the connector, it may cause a contact loss.

- If the connector-mounted FPC is installed at a location or in any equipment that will subject the FPC to continuous shake or movement, secure the FPC or take any countermeasure against FPC disconnection from the connector.

- Use FPCs that conform to the appropriate specifications and size as stated or recommended by OMRON.

When using a different FPC, or an FFC, contact OMRON.

- Use the same metal for the FPC plating and the connector plating.

- “Whiskers” may protrude from the FPC film of some lead-free FPCs. Be careful when using these units.

- Ensure a metal mask thickness of $t = 0.12$ to 0.15 mm.

The recommended metal mask open area is 90% of the printed circuit board mating dimensions given in the dimensions diagrams.

● For Mounting

- Do not mount (reflow or manual soldering) the connector to PCB with FPC inserted in the connector. Doing so may result in contact failure.

- The reflow conditions are as stated in OMRON's specifications and guidelines.

These conditions, however, depend on the type of solder, the manufacturer, the amount of solder, the size of the circuit board, and the other mounting materials.

- When mounting the connector by manual soldering, observe the following precautions to ensure contact reliability.

(1) Conditions for manual soldering: $350 \pm 10^\circ\text{C}$ 3 ± 1 sec

(2) Do not apply an excessive amount of solder. Excessive solder will cause the flux to rise.

(3) Do not apply the soldering iron to the mount attachments using force. Doing so may cause the connectors to change shape.

(4) Do not apply the soldering iron to any parts of the connector other than the mount attachments. Doing so may cause the connector to change shape.

- There are case that the following phenomenon is sometimes occurred. However there are no bad influences to functions and performance of the connector.

(1) Occurrence of black spot to plastic parts

(2) Occurrence of a weld line to plastic parts

(3) Occurrence of the blister to the plastic parts

(4) Occurrence of discoloration to plating parts of terminal and hold-down or plastic parts of slider after reflow.

● For Board Mounting

- Be careful of board warping. The connector flatness is 0.1 mm max. A large amount of warping, however, may result in soldering faults.

- Do not apply excessive force on the connector before mounting it. The connector may be damaged, resulting in faulty contacts. Do not insert the FPC and lock the slider before mounting the connector.

- Be careful not to apply an excessive load on the board when performing the following actions. The connector may be damaged, resulting in faulty contacts.

(1) Dividing multi-cavity boards.

(2) Securing a board with screws.

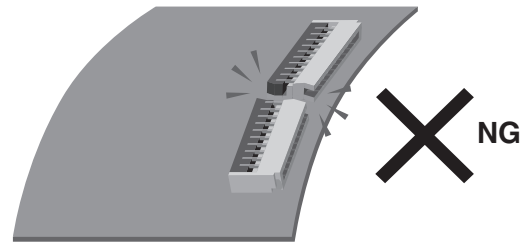

● Storage

(1) Do not store the connectors in locations subject to dust or high humidity.

(2) Do not store the connectors in locations close to sources of gasses such ammonia gas or sulfide gas.

For Slidelocking Models

● For Operating

- When locking the slider, apply pressure to both sides or the entire slider, then push the slider all the way in.

Not doing so may result in contact failure.

● For Designing

- When designing the board, be sure to allow unlocking and operating space for the slider.

- XF2J, XF2M, XF2W and XF3M series are available to use FFC cable.

Please check any condition of each cable in spec sheet, or contact with our Sales side.

Operating the XF Rotary Backlock

FPC connector parts

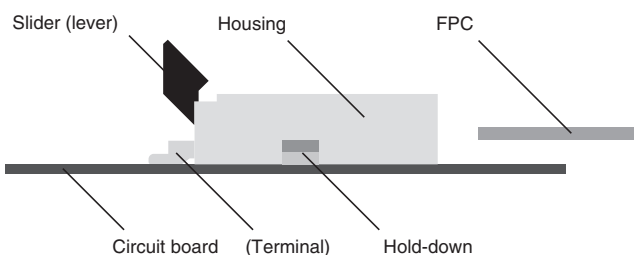

Handling Methods

● For Inserting the FPC

(1) Insert the FPC fully to the back of the connector.

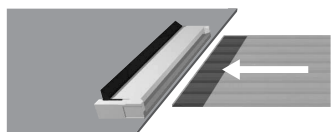

The slider (lever) shown open

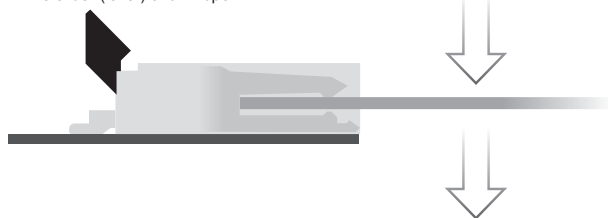

(2) Activate the slider (lever) and lock the FPC in place.

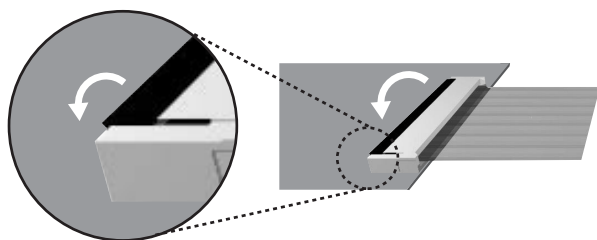

The slider (lever) shown locked

(1) Move the slider (lever) upwards to disengage the locking mechanism.

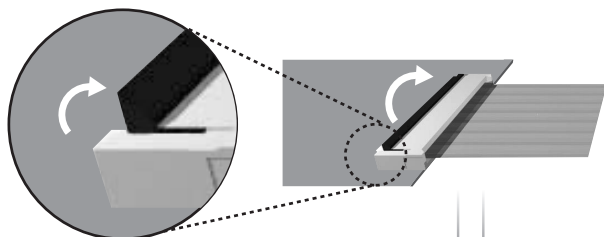

(2) Once the lock has been disengaged, pull the FPC out.

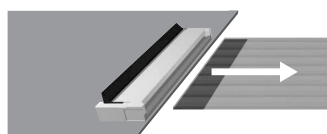

Precautions during Use

● For Operating

(1) Do not lock the slider (lever) without an FPC inserted. Locking the slider (lever) without an FPC inserted will increase the force required to insert an FPC.

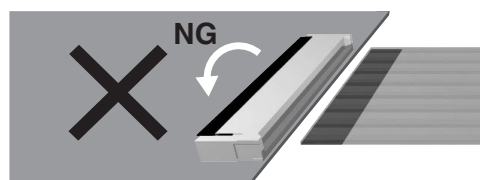

(2) Do not lock or unlock the slider (lever) with excessive force. The connector may be damaged, resulting in faulty contacts. Do not use the slider (lever) again if it becomes detached.

(3) When locking the slider (lever), apply pressure with your fingertips to both sides of the slider (lever) and then twist the slider (lever) until it comes away from the unit. Failing to lock the slider (lever) properly may result in contact failure.

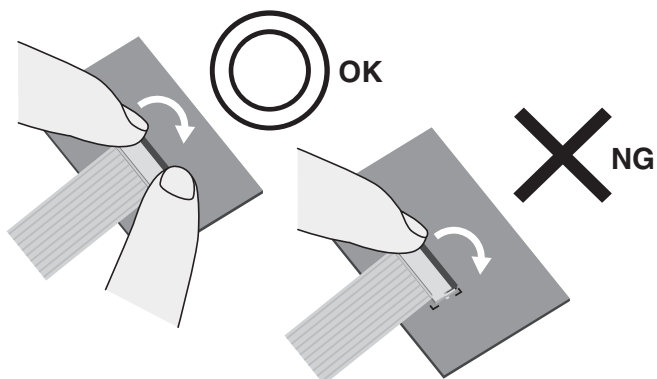

Do not apply force horizontally to the PCB when locking the slider (lever).

The connector may be damaged, resulting in faulty contacts.

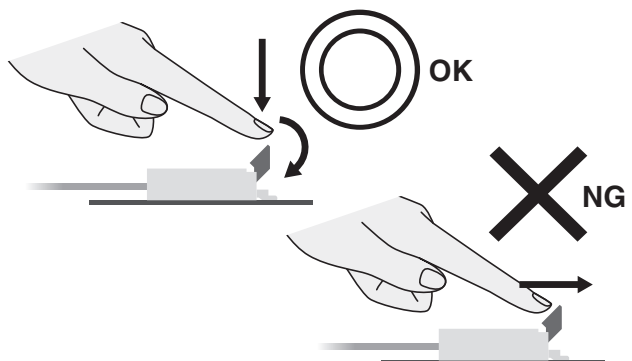

Operating the XF Rotary Backlock

- (4) When unlocking the slider (lever), place your fingers on either side or the entire slider (lever) and slowly lift the slider (lever) up and away.

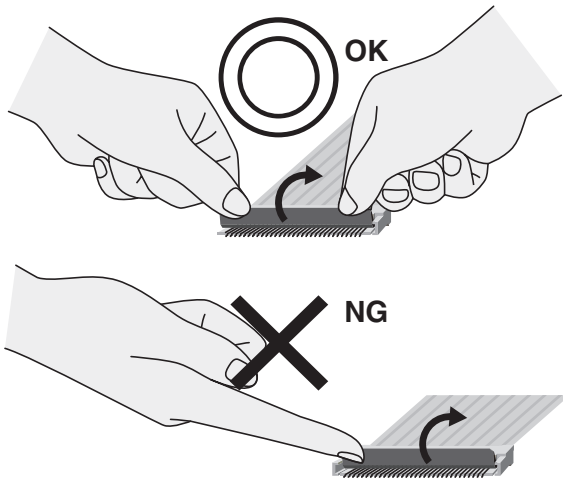

Do not engage the slider past its initial location during the unlocking process.

The connector may be damaged, resulting in faulty contacts.

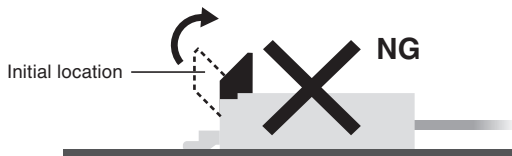

Performing the following action may cause the terminals to change shape or otherwise cause contact failures.

- Using tweezers to unlock the slider (lever).

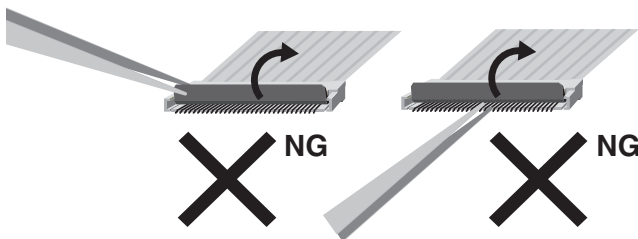

- (5) When inserting and drawing out the FPC, be sure to check that the slider (lever) has been unlocked first.

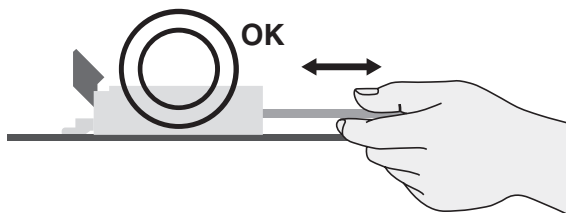

Using the FPC in the following ways may damage the FPC, change the shape of the contacts, or result in contact failure.

- Drawing out the FPC when the slider (lever) is still locked.

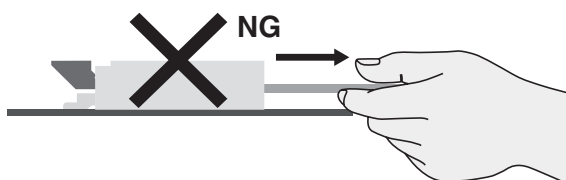

- Drawing out the FPC by pulling it up and down or from left to right or twisting it sideways.

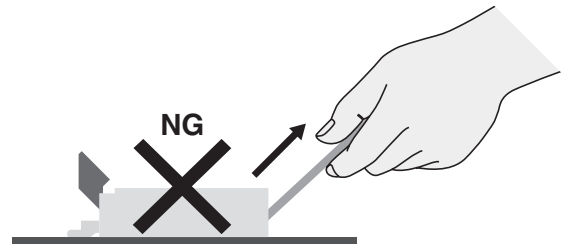

- (6) Make sure that the FPC has been inserted correctly.

If the FPC is inserted incorrectly from the customer's design specification, the pin number will not match and it may damage the contacts or cause malfunction of the equipment.

• For Mounting

- (1) Do not perform reflow or manual soldering with the FPC inserted in the connector and the slider (lever) in the locked position. Doing so may result in contact failure.
- (2) The reflow conditions are as stated in OMRON's specifications and guidelines. These conditions, however, depend on the type of solder, the manufacturer, the amount of solder, the size of the circuit board, and the other mounting materials.

• For Designing

- (1) Design the FPC so that extreme peel force should not be applied directly on to the connector. If the FPC bends near the connector, or if the FPC is used with extreme peel force directly on to the connector, it may cause a contact loss.
- (2) If the FPC is installed at a location or in any equipment that will subject the FPC to continuous shake or movement, secure the FPC.
- (3) Use FPCs that conform to the appropriate specifications and size as stated or recommended by OMRON. When using a different FPC, or an FFC, contact OMRON.
- (4) Use the same metal for the FPC plating and the connector plating.
- (5) "Whiskers" may protrude from the FPC film of some lead-free FPCs. Be careful when using these units.
- (6) When designing the board, be sure to allow locking and operating space for the slider (lever).

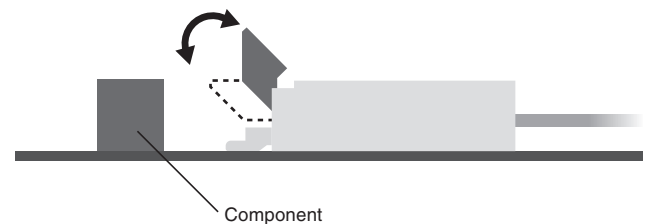

- (7) Make sure that the metal mask thickness is within the appropriate specifications and size as stated by OMRON. The recommended metal mask open area is 90% of the printed circuit board mating dimensions given in the dimensions diagrams.

- XF2J, XF2M, XF2W and XF3M series are available to use FFC cable.

Please check any condition of each cable in spec sheet, or contact with our Sales side.

Operating the XF Rotary Frontlock

FPC connector parts

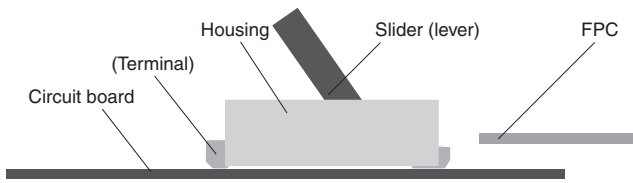

Handling Methods

● For Inserting the FPC

- (1) When unlocking the slider, use your fingernail to rotate and lift the slider.

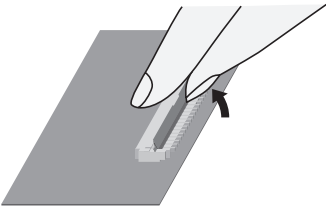

- (2) Securely insert the FPC so that it is perpendicular to the connector and horizontal to the connector.



- (3) When locking the slider, apply pressure with your fingertips to the center of the slider, then twist the slider until it comes away from the unit.

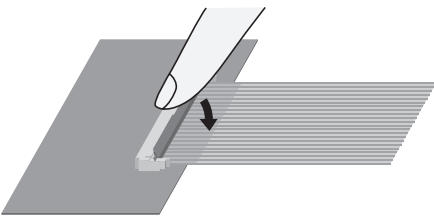

● For Drawing Out the FPC

- (1) Unlock the slider by pushing it up, then remove the FPC.

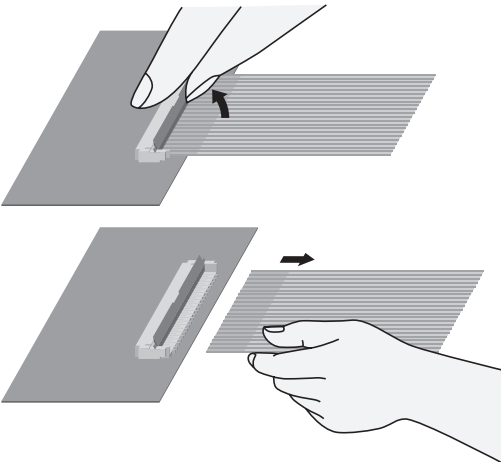

Precautions during Use

● For Operating

- (1) The slider mechanism rotates around a rotary shaft. Operate the slider in a rotating movement.

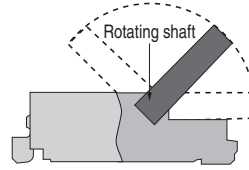

- (2) The slider cannot be opened to an angle of more than 125 degrees. Do not apply force on the slider beyond that point. The connector may be damaged, resulting in faulty contacts. Do not use the connector of which the slider has once come off.

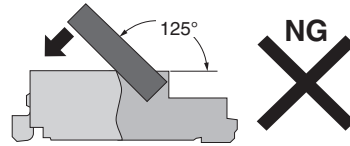

- (3) Lock and unlock the slider using the center of the slider. Using the end of the slider may result in incomplete locking, damage, or contact failure.

- (4) As shown in the following figure, do not touch the terminals with your fingernail or fingers if using the slider without the FPC inserted. Doing so may cause the terminals to change shape and result in contact failure.

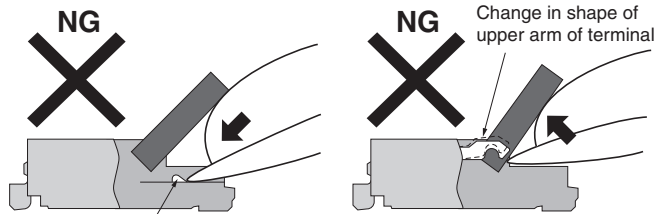

Change in shape of tip of terminal

- (5) Using the FPC in the follow ways may damage the FPC, change the shape of the contacts, or result in contact failure.

- Drawing out the FPC when the slider (lever) is still locked.

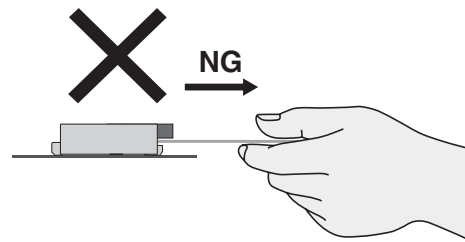

- Drawing out the FPC by pulling it up and down or from left to right or twisting it sideways.

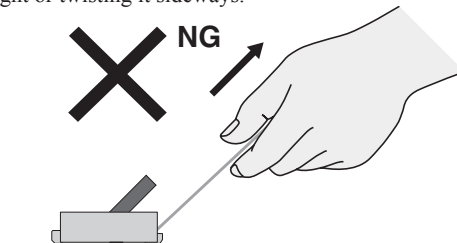

- (6) Make sure that the FPC has been inserted correctly.

If the FPC is inserted incorrectly from the customer's design specification, the pin number will not match and it may damage the contacts or cause malfunction of the equipment.

- For Mounting

- (1) Do not perform reflow or manual soldering with the FPC inserted in the connector. Doing so may result in contact failure.
- (2) The reflow conditions are as stated in OMRON's specifications and guidelines. These conditions, however, depend on the type of solder, the manufacturer, the amount of solder, the size of the circuit board, and the other mounting materials.

- For Designing

- (1) Design the FPC so that extreme peel force should not be applied directly on to the connector. If the FPC bends near the connector, or if the FPC is used with extreme peel force directly on to the connector, it may cause a contact loss.
- (2) If the FPC is installed at a location or in any equipment that will subject the FPC to continuous shake or movement, secure the FPC.
- (3) Use FPCs that conform to the appropriate specifications and size as stated or recommended by OMRON. When using a different FPC, or an FFC, contact OMRON.
- (4) Use the same metal for the FPC plating and the connector plating.
- (5) "Whiskers" may protrude from the FPC film of some lead-free FPCs. Be careful when using these units.
- (6) Make sure that the metal mask thickness is within the appropriate specifications and size as stated by OMRON. The recommended metal mask open area is 90% of the printed circuit board mating dimensions given in the dimensions diagrams.

- Application examples provided in this document are for reference only. In actual applications, confirm equipment functions and safety before using the product.
- Consult your OMRON representative before using the product under conditions which are not described in the manual or applying the product to nuclear control systems, railroad systems, aviation systems, vehicles, combustion systems, medical equipment, amusement machines, safety equipment, and other systems or equipment that may have a serious influence on lives and property if used improperly. Make sure that the ratings and performance characteristics of the product provide a margin of safety for the system or equipment, and be sure to provide the system or equipment with double safety mechanisms.

Note: Do not use this document to operate the Unit.

Компания «Life Electronics» занимается поставками электронных компонентов импортного и отечественного производства от производителей и со складов крупных дистрибьюторов Европы, Америки и Азии.

С конца 2013 года компания активно расширяет линейку поставок компонентов по направлению коаксиальный кабель, кварцевые генераторы и конденсаторы (керамические, пленочные, электролитические), за счёт заключения дистрибьюторских договоров

Мы предлагаем:

- Конкурентоспособные цены и скидки постоянным клиентам.
- Специальные условия для постоянных клиентов.
- Подбор аналогов.
- Поставку компонентов в любых объемах, удовлетворяющих вашим потребностям.
- Приемлемые сроки поставки, возможна ускоренная поставка.
- Доставку товара в любую точку России и стран СНГ.
- Комплексную поставку.
- Работу по проектам и поставку образцов.
- Формирование склада под заказчика.
- Сертификаты соответствия на поставляемую продукцию (по желанию клиента).
- Тестирование поставляемой продукции.
- Поставку компонентов, требующих военную и космическую приемку.
- Входной контроль качества.
- Наличие сертификата ISO.

В составе нашей компании организован Конструкторский отдел, призванный помогать разработчикам, и инженерам.

Конструкторский отдел помогает осуществить:

- Регистрацию проекта у производителя компонентов.
- Техническую поддержку проекта.
- Защиту от снятия компонента с производства.
- Оценку стоимости проекта по компонентам.
- Изготовление тестовой платы монтаж и пусконаладочные работы.



Тел: +7 (812) 336 43 04 (многоканальный)

Email: org@lifeelectronics.ru