

TIP31, TIP31A, TIP31B, TIP31C, (NPN), TIP32, TIP32A, TIP32B, TIP32C, (PNP)



ON Semiconductor®

<http://onsemi.com>

Complementary Silicon Plastic Power Transistors

Designed for use in general purpose amplifier and switching applications.

Features

- Collector–Emitter Saturation Voltage –
 $V_{CE(sat)} = 1.2 \text{ Vdc (Max) @ } I_C = 3.0 \text{ Adc}$
- Collector–Emitter Sustaining Voltage –
 $V_{CEO(sus)} = 40 \text{ Vdc (Min) – TIP31, TIP32}$
 $= 60 \text{ Vdc (Min) – TIP31A, TIP32A}$
 $= 80 \text{ Vdc (Min) – TIP31B, TIP32B}$
 $= 100 \text{ Vdc (Min) – TIP31C, TIP32C}$
- High Current Gain – Bandwidth Product
 $f_T = 3.0 \text{ MHz (Min) @ } I_C = 500 \text{ mAdc}$
- Compact TO–220 AB Package
- Pb–Free Packages are Available*

MAXIMUM RATINGS

Rating	Symbol	Value	Unit
Collector – Emitter Voltage TIP31, TIP32 TIP31A, TIP32A TIP31B, TIP32B TIP31C, TIP32C	V_{CEO}	40 60 80 100	Vdc
Collector–Base Voltage TIP31, TIP32 TIP31A, TIP32A TIP31B, TIP32B TIP31C, TIP32C	V_{CB}	40 60 80 100	Vdc
Emitter–Base Voltage	V_{EB}	5.0	Vdc
Collector Current Continuous Peak	I_C	3.0 5.0	Adc
Base Current	I_B	1.0	Adc
Total Power Dissipation @ $T_C = 25^\circ\text{C}$ Derate above 25°C	P_D	40 0.32	W W/ $^\circ\text{C}$
Total Power Dissipation @ $T_A = 25^\circ\text{C}$ Derate above 25°C	P_D	2.0 0.016	W W/ $^\circ\text{C}$
Unclamped Inductive Load Energy (Note 1)	E	32	mJ
Operating and Storage Junction Temperature Range	T_J, T_{stg}	–65 to +150	$^\circ\text{C}$

Stresses exceeding Maximum Ratings may damage the device. Maximum Ratings are stress ratings only. Functional operation above the Recommended Operating Conditions is not implied. Extended exposure to stresses above the Recommended Operating Conditions may affect device reliability.

1. $I_C = 1.8 \text{ A}$, $L = 20 \text{ mH}$, $P.R.F. = 10 \text{ Hz}$, $V_{CC} = 10 \text{ V}$, $R_{BE} = 100 \Omega$

*For additional information on our Pb–Free strategy and soldering details, please download the ON Semiconductor Soldering and Mounting Techniques Reference Manual, SOLDERRM/D.

3 AMPERE POWER TRANSISTORS COMPLEMENTARY SILICON 40–60–80–100 VOLTS, 40 WATTS

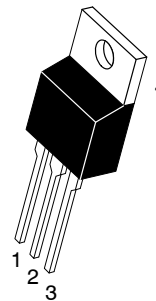

TO–220AB
CASE 221A
STYLE 1

PIN 1. BASE
2. COLLECTOR
3. EMITTER
4. COLLECTOR

MARKING DIAGRAM



TIP3xx = Device Code
xx = 1, 1A, 1B, 1C,
2, 2A, 2B, 2C,
A = Assembly Location
Y = Year
WW = Work Week
G = Pb–Free Package

ORDERING INFORMATION

See detailed ordering and shipping information in the package dimensions section on page 3 of this data sheet.

TIP31, TIP31A, TIP31B, TIP31C, (NPN), TIP32, TIP32A, TIP32B, TIP32C, (PNP)

THERMAL CHARACTERISTICS

Characteristic	Symbol	Max	Unit
Thermal Resistance, Junction-to-Ambient	$R_{\theta JA}$	62.5	$^{\circ}\text{C}/\text{W}$
Thermal Resistance, Junction-to-Case	$R_{\theta JC}$	3.125	$^{\circ}\text{C}/\text{W}$

ELECTRICAL CHARACTERISTICS ($T_C = 25^{\circ}\text{C}$ unless otherwise noted)

Characteristic	Symbol	Min	Max	Unit
----------------	--------	-----	-----	------

OFF CHARACTERISTICS

Collector-Emitter Sustaining Voltage (Note 2) ($I_C = 30 \text{ mAdc}$, $I_B = 0$)	TIP31, TIP32 TIP31A, TIP32A TIP31B, TIP32B TIP31C, TIP32C	$V_{CE(sus)}$	40 60 80 100	- - - -	Vdc
Collector Cutoff Current ($V_{CE} = 30 \text{ Vdc}$, $I_B = 0$) ($V_{CE} = 60 \text{ Vdc}$, $I_B = 0$)	TIP31, TIP32, TIP31A, TIP32A TIP31B, TIP31C, TIP32B, TIP32C	I_{CEO}	- -	0.3 0.3	mAdc
Collector Cutoff Current ($V_{CE} = 40 \text{ Vdc}$, $V_{EB} = 0$) ($V_{CE} = 60 \text{ Vdc}$, $V_{EB} = 0$) ($V_{CE} = 80 \text{ Vdc}$, $V_{EB} = 0$) ($V_{CE} = 100 \text{ Vdc}$, $V_{EB} = 0$)	TIP31, TIP32 TIP31A, TIP32A TIP31B, TIP32B TIP31C, TIP32C	I_{CES}	- - - -	200 200 200 200	μAdc
Emitter Cutoff Current ($V_{BE} = 5.0 \text{ Vdc}$, $I_C = 0$)		I_{EBO}	-	1.0	mAdc

ON CHARACTERISTICS (Note 2)

DC Current Gain ($I_C = 1.0 \text{ Adc}$, $V_{CE} = 4.0 \text{ Vdc}$) ($I_C = 3.0 \text{ Adc}$, $V_{CE} = 4.0 \text{ Vdc}$)		h_{FE}	25 10	- 50	-
Collector-Emitter Saturation Voltage ($I_C = 3.0 \text{ Adc}$, $I_B = 375 \text{ mAdc}$)		$V_{CE(sat)}$	-	1.2	Vdc
Base-Emitter On Voltage ($I_C = 3.0 \text{ Adc}$, $V_{CE} = 4.0 \text{ Vdc}$)		$V_{BE(on)}$	-	1.8	Vdc

DYNAMIC CHARACTERISTICS

Current-Gain - Bandwidth Product ($I_C = 500 \text{ mAdc}$, $V_{CE} = 10 \text{ Vdc}$, $f_{test} = 1.0 \text{ MHz}$)		f_T	3.0	-	MHz
Small-Signal Current Gain ($I_C = 0.5 \text{ Adc}$, $V_{CE} = 10 \text{ Vdc}$, $f = 1.0 \text{ kHz}$)		h_{fe}	20	-	-

2. Pulse Test: Pulse Width $\leq 300 \mu\text{s}$, Duty Cycle $\leq 2.0\%$.

TIP31, TIP31A, TIP31B, TIP31C, (NPN), TIP32, TIP32A, TIP32B, TIP32C, (PNP)



Figure 1. Darlington Circuit Schematic

ORDERING INFORMATION

Device	Package	Shipping
TIP31	TO-220	50 Units / Rail
TIP31G	TO-220 (Pb-Free)	50 Units / Rail
TIP31A	TO-220	50 Units / Rail
TIP31AG	TO-220 (Pb-Free)	50 Units / Rail
TIP31B	TO-220	50 Units / Rail
TIP31BG	TO-220 (Pb-Free)	50 Units / Rail
TIP31C	TO-220	50 Units / Rail
TIP31CG	TO-220 (Pb-Free)	50 Units / Rail
TIP32	TO-220	50 Units / Rail
TIP32G	TO-220 (Pb-Free)	50 Units / Rail
TIP32A	TO-220	50 Units / Rail
TIP32AG	TO-220 (Pb-Free)	50 Units / Rail
TIP32B	TO-220	50 Units / Rail
TIP32BG	TO-220 (Pb-Free)	50 Units / Rail
TIP32C	TO-220	50 Units / Rail
TIP32CG	TO-220 (Pb-Free)	50 Units / Rail

TIP31, TIP31A, TIP31B, TIP31C, (NPN), TIP32, TIP32A, TIP32B, TIP32C, (PNP)

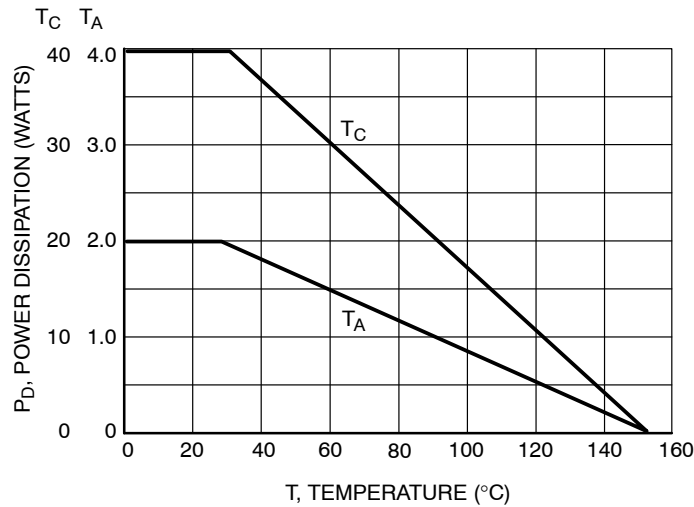
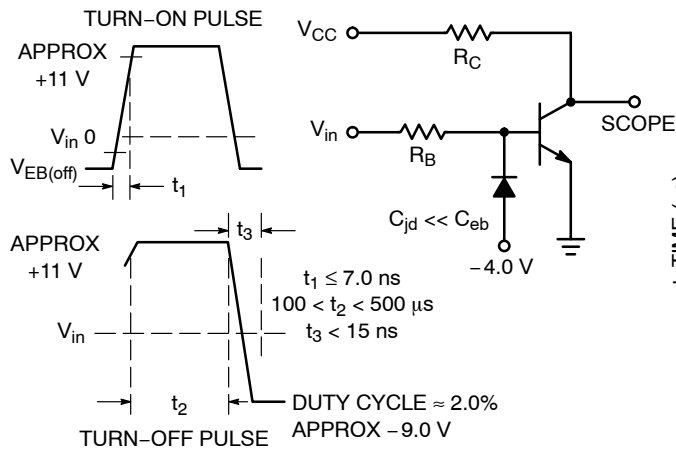

Figure 2. Power Derating



R_B and R_C VARIED TO OBTAIN DESIRED CURRENT LEVELS.

Figure 3. Switching Time Equivalent Circuit

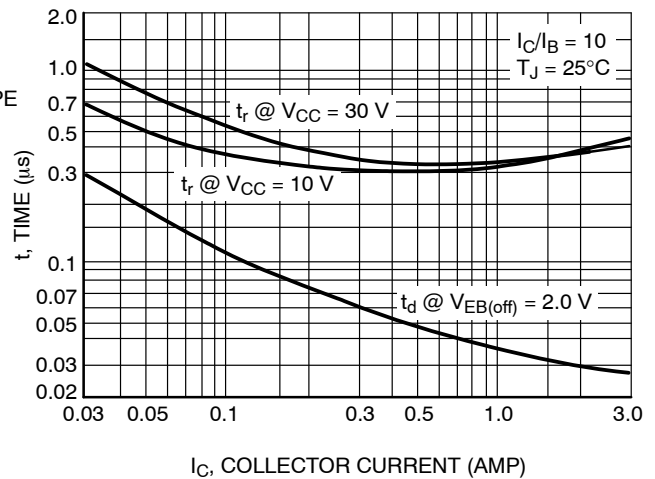

Figure 4. Turn-On Time

TIP31, TIP31A, TIP31B, TIP31C, (NPN), TIP32, TIP32A, TIP32B, TIP32C, (PNP)

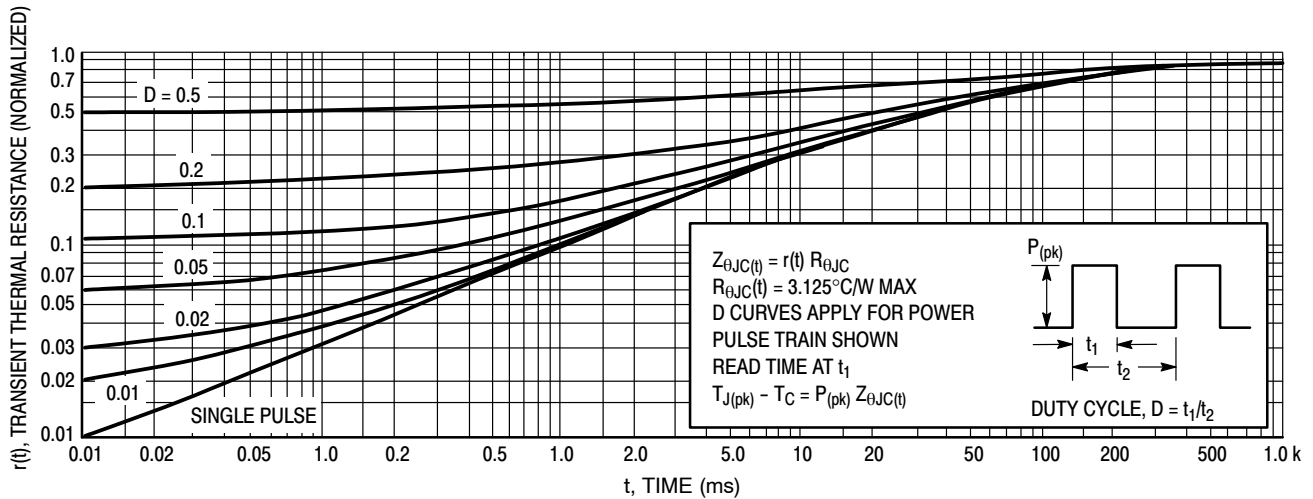

Figure 5. Thermal Response



Figure 6. Active Region Safe Operating Area

There are two limitations on the power handling ability of a transistor: average junction temperature and second breakdown. Safe operating area curves indicate $I_C - V_{CE}$ limits of the transistor that must be observed for reliable operation; i.e., the transistor must not be subjected to greater dissipation than the curves indicate.

The data of Figure 6 is based on $T_{J(pk)} = 150^\circ\text{C}$; T_C is variable depending on conditions. Second breakdown pulse limits are valid for duty cycles to 10% provided $T_{J(pk)} \leq 150^\circ\text{C}$. $T_{J(pk)}$ may be calculated from the data in Figure 5. At high case temperatures, thermal limitations will reduce the power that can be handled to values less than the limitations imposed by second breakdown.



Figure 7. Turn-Off Time



Figure 8. Capacitance

TIP31, TIP31A, TIP31B, TIP31C, (NPN), TIP32, TIP32A, TIP32B, TIP32C, (PNP)

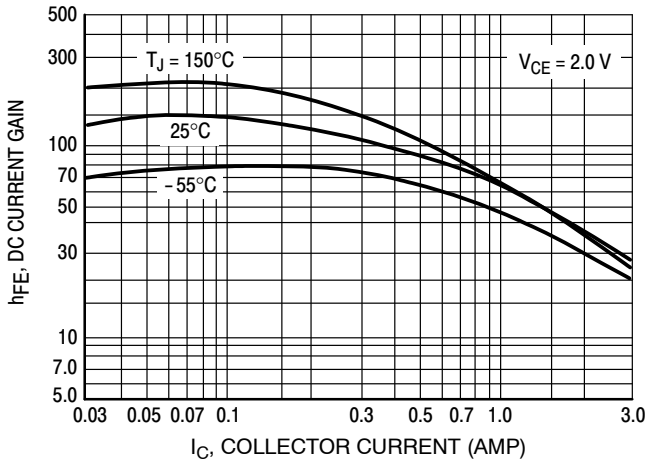

Figure 9. DC Current Gain

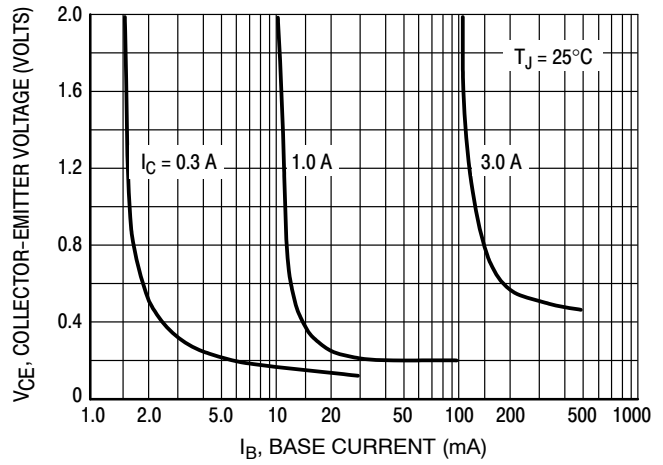

Figure 10. Collector Saturation Region

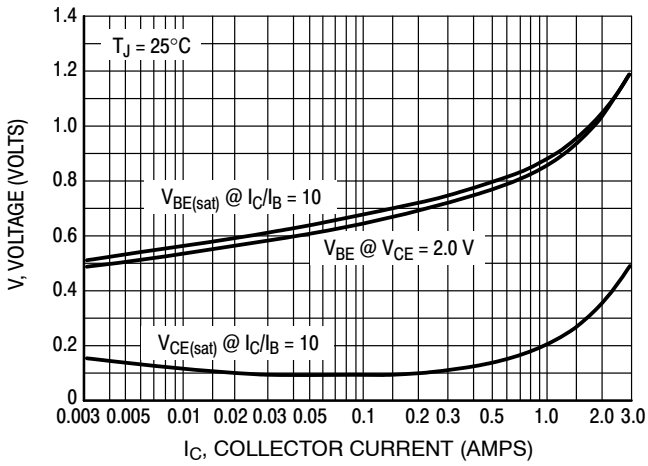

Figure 11. "On" Voltages

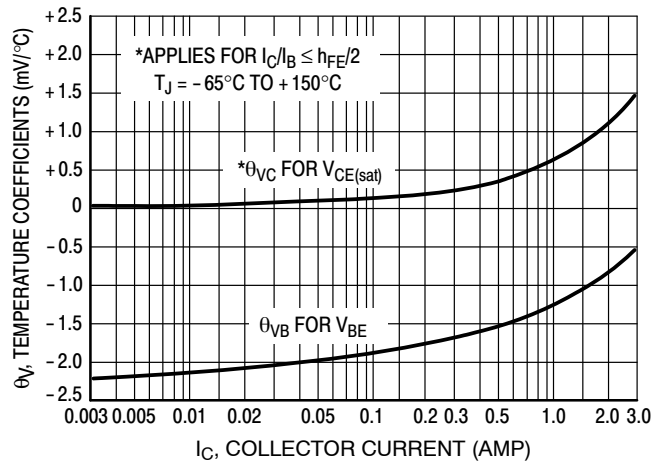

Figure 12. Temperature Coefficients

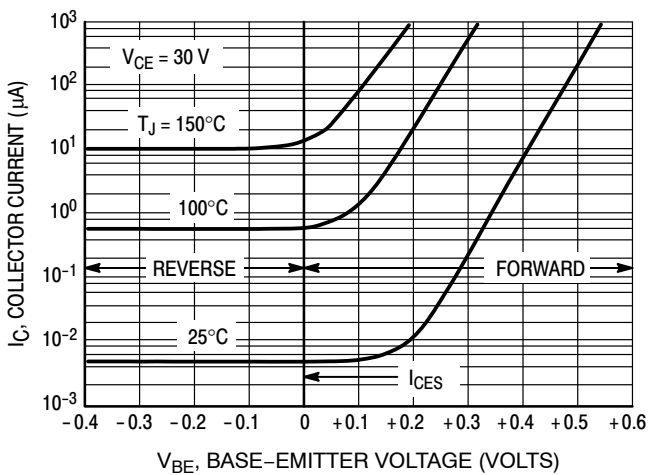

Figure 13. Collector Cut-Off Region

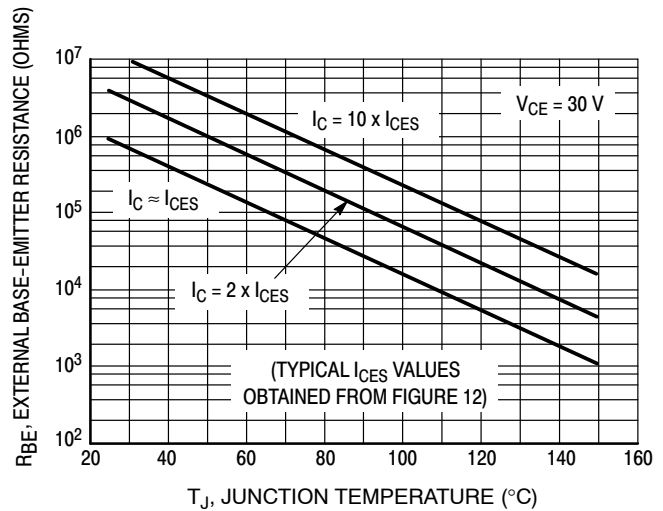
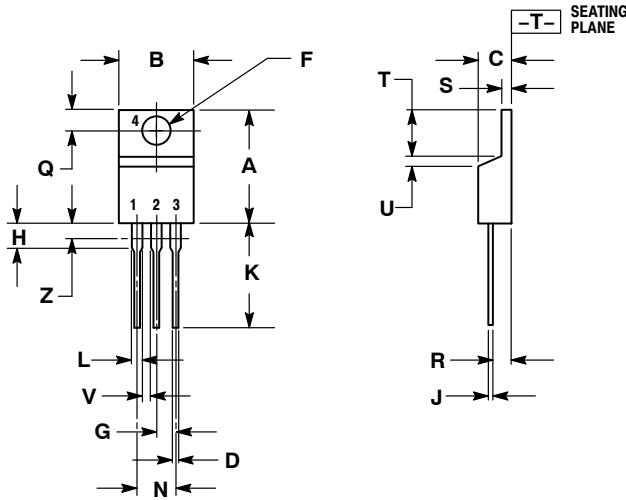

Figure 14. Effects of Base-Emitter Resistance

TIP31, TIP31A, TIP31B, TIP31C, (NPN), TIP32, TIP32A, TIP32B, TIP32C, (PNP)

PACKAGE DIMENSIONS

TO-220 CASE 221A-09 ISSUE AG



NOTES:

1. DIMENSIONING AND TOLERANCING PER ANSI Y14.5M, 1982.
2. CONTROLLING DIMENSION: INCH.
3. DIMENSION Z DEFINES A ZONE WHERE ALL BODY AND LEAD IRREGULARITIES ARE ALLOWED.

DIM	INCHES		MILLIMETERS	
	MIN	MAX	MIN	MAX
A	0.570	0.620	14.48	15.75
B	0.380	0.405	9.66	10.28
C	0.160	0.190	4.07	4.82
D	0.025	0.036	0.64	0.91
F	0.142	0.161	3.61	4.09
G	0.095	0.105	2.42	2.66
H	0.110	0.161	2.80	4.10
J	0.014	0.025	0.36	0.64
K	0.500	0.562	12.70	14.27
L	0.045	0.060	1.15	1.52
N	0.190	0.210	4.83	5.33
Q	0.100	0.120	2.54	3.04
R	0.080	0.110	2.04	2.79
S	0.045	0.055	1.15	1.39
T	0.235	0.255	5.97	6.47
U	0.000	0.050	0.00	1.27
V	0.045	---	1.15	---
Z	---	0.080	---	2.04

STYLE 1:

- PIN 1. BASE
- COLLECTOR
- EMITTER
- COLLECTOR

ON Semiconductor and are registered trademarks of Semiconductor Components Industries, LLC (SCILLC). SCILLC reserves the right to make changes without further notice to any products herein. SCILLC makes no warranty, representation or guarantee regarding the suitability of its products for any particular purpose, nor does SCILLC assume any liability arising out of the application or use of any product or circuit, and specifically disclaims any and all liability, including without limitation special, consequential or incidental damages. "Typical" parameters which may be provided in SCILLC data sheets and/or specifications can and do vary in different applications and actual performance may vary over time. All operating parameters, including "Typicals" must be validated for each customer application by customer's technical experts. SCILLC does not convey any license under its patent rights nor the rights of others. SCILLC products are not designed, intended, or authorized for use as components in systems intended for surgical implant into the body, or other applications intended to support or sustain life, or for any other application in which the failure of the SCILLC product could create a situation where personal injury or death may occur. Should Buyer purchase or use SCILLC products for any such unintended or unauthorized application, Buyer shall indemnify and hold SCILLC and its officers, employees, subsidiaries, affiliates, and distributors harmless against all claims, costs, damages, and expenses, and reasonable attorney fees arising out of, directly or indirectly, any claim of personal injury or death associated with such unintended or unauthorized use, even if such claim alleges that SCILLC was negligent regarding the design or manufacture of the part. SCILLC is an Equal Opportunity/Affirmative Action Employer. This literature is subject to all applicable copyright laws and is not for resale in any manner.

PUBLICATION ORDERING INFORMATION

LITERATURE FULFILLMENT:

Literature Distribution Center for ON Semiconductor
P.O. Box 5163, Denver, Colorado 80217 USA
Phone: 303-675-2175 or 800-344-3860 Toll Free USA/Canada
Fax: 303-675-2176 or 800-344-3867 Toll Free USA/Canada
Email: orderlit@onsemi.com

N. American Technical Support: 800-282-9855 Toll Free
USA/Canada
Europe, Middle East and Africa Technical Support:
Phone: 421 33 790 2910
Japan Customer Focus Center
Phone: 81-3-5773-3850

ON Semiconductor Website: www.onsemi.com

Order Literature: <http://www.onsemi.com/orderlit>

For additional information, please contact your local Sales Representative

Компания «Life Electronics» занимается поставками электронных компонентов импортного и отечественного производства от производителей и со складов крупных дистрибьюторов Европы, Америки и Азии.

С конца 2013 года компания активно расширяет линейку поставок компонентов по направлению коаксиальный кабель, кварцевые генераторы и конденсаторы (керамические, пленочные, электролитические), за счёт заключения дистрибьюторских договоров

Мы предлагаем:

- Конкурентоспособные цены и скидки постоянным клиентам.
- Специальные условия для постоянных клиентов.
- Подбор аналогов.
- Поставку компонентов в любых объемах, удовлетворяющих вашим потребностям.
- Приемлемые сроки поставки, возможна ускоренная поставка.
- Доставку товара в любую точку России и стран СНГ.
- Комплексную поставку.
- Работу по проектам и поставку образцов.
- Формирование склада под заказчика.
- Сертификаты соответствия на поставляемую продукцию (по желанию клиента).
- Тестирование поставляемой продукции.
- Поставку компонентов, требующих военную и космическую приемку.
- Входной контроль качества.
- Наличие сертификата ISO.

В составе нашей компании организован Конструкторский отдел, призванный помогать разработчикам, и инженерам.

Конструкторский отдел помогает осуществить:

- Регистрацию проекта у производителя компонентов.
- Техническую поддержку проекта.
- Защиту от снятия компонента с производства.
- Оценку стоимости проекта по компонентам.
- Изготовление тестовой платы монтаж и пусконаладочные работы.



Тел: +7 (812) 336 43 04 (многоканальный)
Email: org@lifeelectronics.ru