

HLMP-CBxx, HLMP-CMxx T-1³/₄ (5 mm) InGaN Blue and Green LEDs

Description

These high-intensity blue and green LEDs are based on the most efficient and cost-effective InGaN material technology.

These LED lamps are untinted and non-diffused T-1³/₄ packages incorporating second generation optics producing well-defined spatial radiation patterns at specific viewing cone angles.

These lamps are made with an advanced optical grade epoxy offering superior high temperature and high moisture resistance performance in outdoor signal and sign applications. The epoxy contains UV inhibitors to reduce the effects of long term exposure to direct sunlight.

Features

- Viewing angle: 15°, 23°, and 30°
- Well-defined spatial radiation pattern
- High luminous output
- Available in blue and green
 - Blue 470 nm
 - Green 525 nm
- Superior resistance to moisture
- Standoff and non-standoff package

Applications

- Traffic signs
- Variable message signs
- Commercial outdoor advertising

CAUTION! InGaN devices are Class 1C HBM ESD sensitive per JEDEC Standard. Please observe appropriate precautions during handling and processing. Refer to Application Note AN-1142 for additional details.

Figure 1: Package Dimensions

Drawing A (Non-standoff)

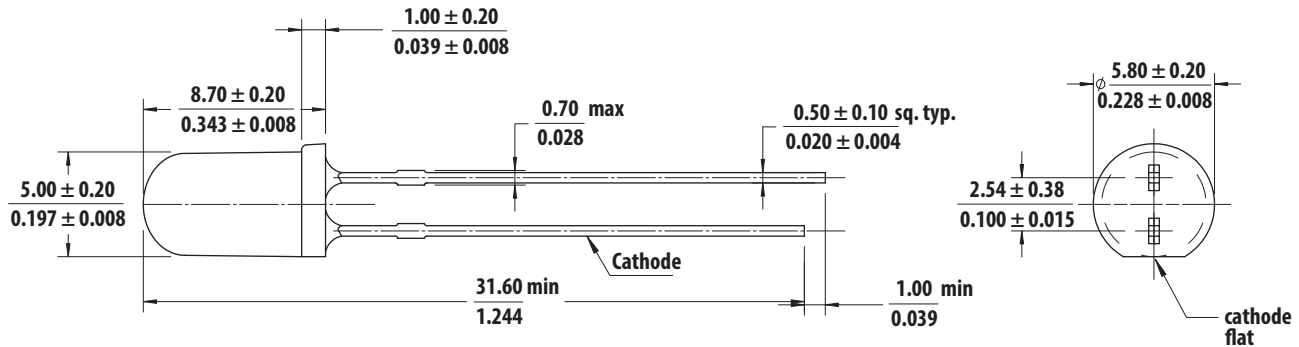

Drawing B (Standoff)

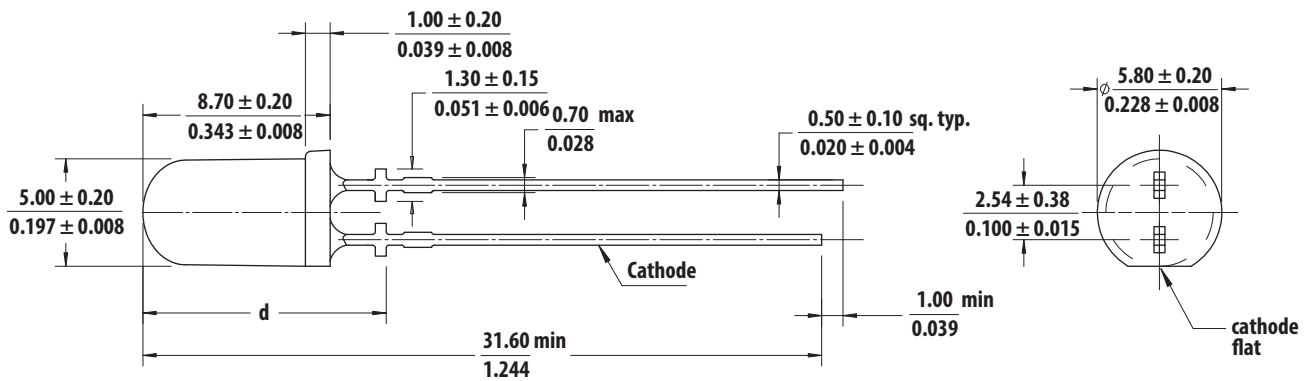

Part Number	Dimension 'd'
HLMP-Cx1H	12.39 mm \pm 0.25 mm
HLMP-Cx2H	12.35 mm \pm 0.25 mm
HLMP-Cx3H	11.93 mm \pm 0.25 mm

NOTE:

1. All dimensions in millimeters (inches).
2. Tolerance is ± 0.20 mm unless other specified.
3. Leads are mild steel with tin plating.
4. The epoxy meniscus is 1.5 mm maximum.

Device Selection Guide

Part Number	Color and Dominant Wavelength λ_d (nm) Typ. ^a [3]	Luminous Intensity I_v (mcd) at 20 mA ^{b, c, d}		Standoff	Typical Viewing Angle (°) ^e
		Min	Max		
HLMP-CB1G-XZ0DD	Blue 470	7200	16000	No	15
HLMP-CB1H-XZ0DD	Blue 470	7200	16000	Yes	
HLMP-CM1G-350DD	Green 525	27000	59000	No	
HLMP-CM1H-350DD	Green 525	27000	59000	Yes	23
HLMP-CB2G-UW0DD	Blue 470	3200	7200	No	
HLMP-CB2H-UW0DD	Blue 470	3200	7200	Yes	
HLMP-CM2G-130DD	Green 525	16000	35000	No	
HLMP-CM2H-130DD	Green 525	16000	35000	Yes	30
HLMP-CB3G-TV0DD	Blue 470	2500	5500	No	
HLMP-CB3H-TV0DD	Blue 470	2500	5500	Yes	
HLMP-CM3G-Y10DD	Green 525	9300	21000	No	
HLMP-CM3H-Y10DD	Green 525	9300	21000	Yes	

- Dominant wavelength, λ_d , is derived from the CIE Chromaticity Diagram and represents the color of the lamp.
- The luminous intensity is measured on the mechanical axis of the lamp package and it is tested with pulsing condition.
- The optical axis is closely aligned with the package mechanical axis.
- Tolerance for each bin limit is $\pm 15\%$.
- $\theta_{1/2}$ is the off-axis angle where the luminous intensity is half the on-axis intensity.

Absolute Maximum Ratings

$T_J = 25^\circ\text{C}$

Parameter	Blue/Green	Unit
DC Forward Current ^a	30	mA
Peak Forward Current ^b	100	mA
Power Dissipation	110	mW
LED Junction Temperature	110	°C
Operating Temperature Range	-40 to +85	°C
Storage Temperature Range	-40 to +100	°C

- Derate linearly as shown in [Figure 5](#).
- Duty factor 10%, frequency 1 kHz.

Electrical/Optical Characteristics

$T_J = 25^\circ\text{C}$

Parameter	Symbol	Min.	Typ.	Max.	Units	Test Conditions
Forward Voltage Blue and Green	V_F	2.8	3.1	3.6	V	$I_F = 20\text{ mA}$
Reverse Voltage ^a Blue and Green	V_R	5	—	—	V	$I_R = 10\ \mu\text{A}$
Dominant Wavelength ^b Blue Green	λ_d	460 520	470 525	480 540	nm	$I_F = 20\text{ mA}$
Peak Wavelength Blue Green	λ_{PEAK}	— —	461 517	— —	nm	Peak of Wavelength of Spectral Distribution at $I_F = 20\text{ mA}$
Thermal resistance	$R\theta_{J-PIN}$	—	240	—	$^\circ\text{C/W}$	LED junction to pin
Luminous Efficacy ^c Blue Green	η_V	— —	68 475	— —	lm/W	Emitted Luminous Power/Emitted Radiant Power
Thermal coefficient of λ_d Blue Green		— —	0.02 0.03	— —	nm/ $^\circ\text{C}$	$I_F = 20\text{ mA}; +25^\circ\text{ C} \leq T_J \leq +100^\circ\text{ C}$

- Indicates product final testing condition, long-term reverse bias is not recommended.
- The dominant wavelength is derived from the Chromaticity Diagram and represents the color of the lamp.
- The radiant intensity, I_e in watts per steradian, maybe found from the equation $I_e = I_v / \eta_V$ where I_v is the luminous intensity in candelas and η_V is the luminous efficacy in lumens/ watt.

Part Numbering System

H L M P -

x ₁	x ₂	x ₃	x ₄
----------------	----------------	----------------	----------------

 -

x ₅	x ₆	x ₇	x ₈	x ₉
----------------	----------------	----------------	----------------	----------------

Code	Description	Option	
x ₁	Package type	C	5-mm Standard Round InGaN
x ₂	Color	B	Blue
		M	Green
x ₃ x ₄	Viewing Angle and Lead Standoffs	1G	15° without lead standoffs
		1H	15° with lead standoffs
		2G	23° without lead standoffs
		2H	23° with lead standoffs
		3G	30° without lead standoffs
		3H	30° with lead standoffs
x ₅	Minimum intensity bin		See Device Selection Guide
x ₆	Maximum intensity bin		See Device Selection Guide
x ₇	Color bin selection	0	Full range
x ₈ x ₉	Packaging option	DD	Ammopack

Bin Information

Intensity Bin Limit Table (1.3:1 Iv Bin Ratio)

Bin	Intensity (mcd) at 20 mA	
	Min	Max
T	2500	3200
U	3200	4200
V	4200	5500
W	5500	7200
X	7200	9300
Y	9300	12000
Z	12000	16000
1	16000	21000
2	21000	27000
3	27000	35000
4	35000	45000
5	45000	59000

Tolerance for each bin limit is ± 15%.

Green Color Bin Table

Bin	Min Dom	Max Dom	Xmin	Ymin	Xmax	Ymax
1	520.0	524.0	0.0743	0.8338	0.1856	0.6556
			0.1650	0.6586	0.1060	0.8292
2	524.0	528.0	0.1060	0.8292	0.2068	0.6463
			0.1856	0.6556	0.1387	0.8148
3	528.0	532.0	0.1387	0.8148	0.2273	0.6344
			0.2068	0.6463	0.1702	0.7965
4	532.0	536.0	0.1702	0.7965	0.2469	0.6213
			0.2273	0.6344	0.2003	0.7764
5	536.0	540.0	0.2003	0.7764	0.2659	0.6070
			0.2469	0.6213	0.2296	0.7543

Tolerance for each bin limit is ± 0.5 nm.

Blue Color Bin Table

Bin	Min Dom	Max Dom	Xmin	Ymin	Xmax	Ymax
1	460.0	464.0	0.1440	0.0297	0.1766	0.0966
			0.1818	0.0904	0.1374	0.0374
2	464.0	468.0	0.1374	0.0374	0.1699	0.1062
			0.1766	0.0966	0.1291	0.0495
3	468.0	472.0	0.1291	0.0495	0.1616	0.1209
			0.1699	0.1062	0.1187	0.0671
4	472.0	476.0	0.1187	0.0671	0.1517	0.1423
			0.1616	0.1209	0.1063	0.0945
5	476.0	480.0	0.1063	0.0945	0.1397	0.1728
			0.1517	0.1423	0.0913	0.1327

Tolerance for each bin limit is ± 0.5 nm.

NOTE: All bin categories are established for classification of products. Products may not be available in all bin categories. Contact your Broadcom® representative for further information.

Broadcom Color Bin on CIE 1931 Chromaticity Diagram

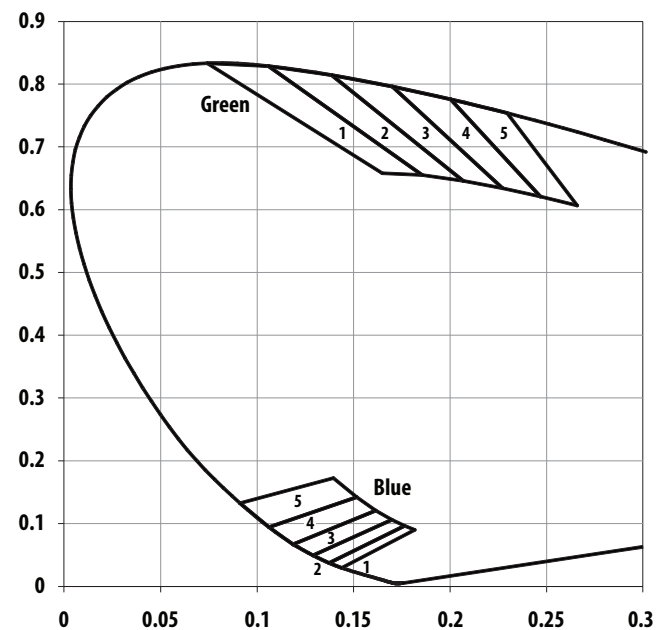

Figure 2: Relative Intensity vs. Wavelength

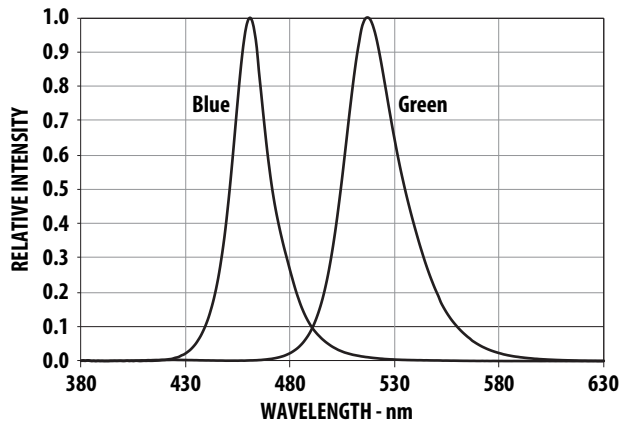

Figure 3: Forward Current vs. Forward Voltage

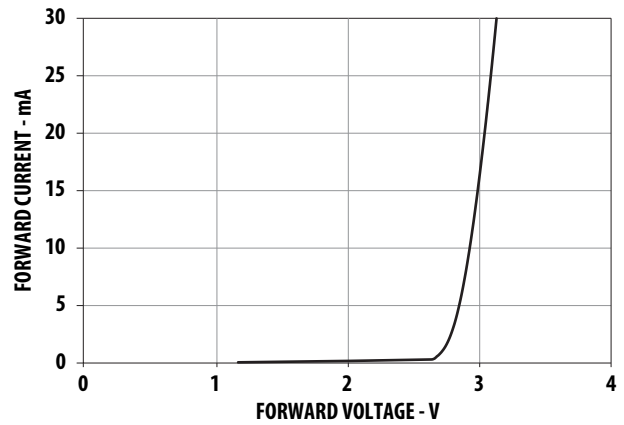

Figure 4: Relative Intensity vs. Forward Current

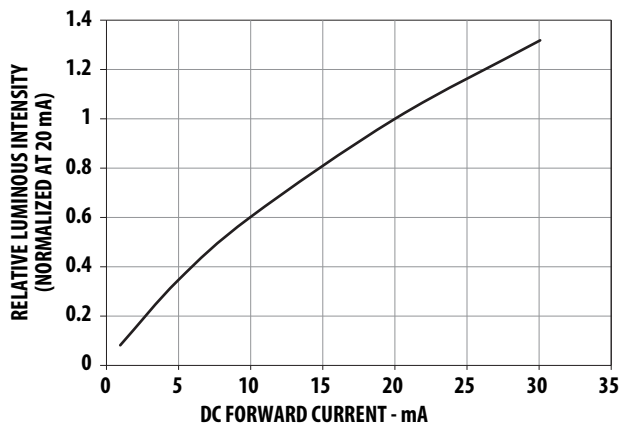

Figure 5: Maximum Forward Current vs. Ambient Temperature

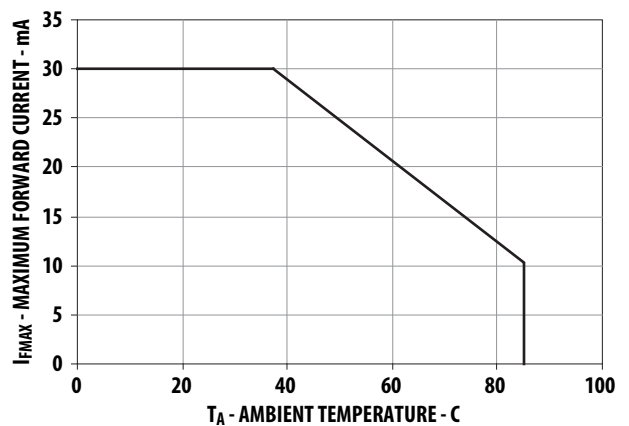

Figure 6: Relative Dominant Wavelength Shift vs. Forward Current

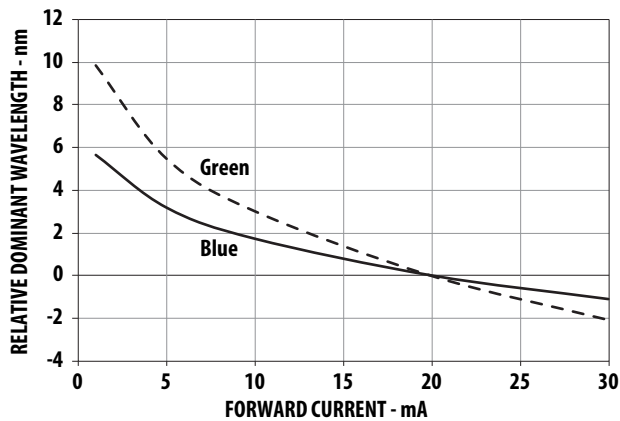

Figure 7: Representative Radiation Pattern for 15° Viewing Angle Lamp

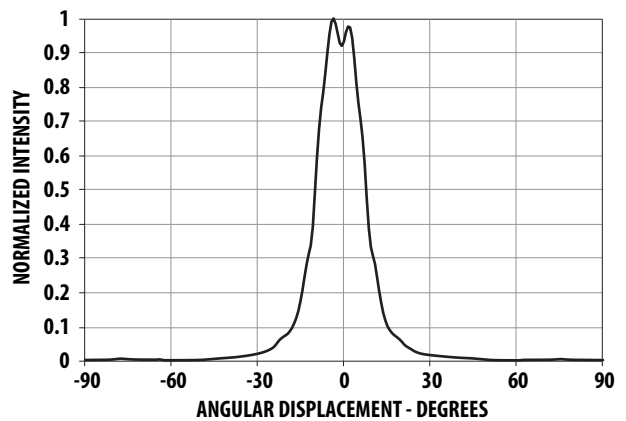

Figure 8: Representative Radiation Pattern for 23° Viewing Angle Lamp

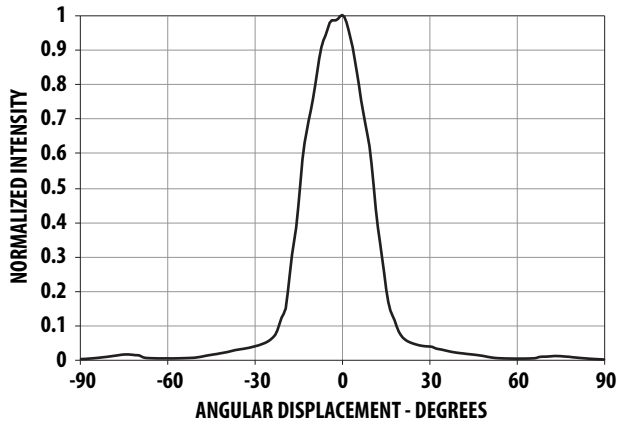

Figure 9: Representative Radiation Pattern for 30° Viewing Angle Lamp

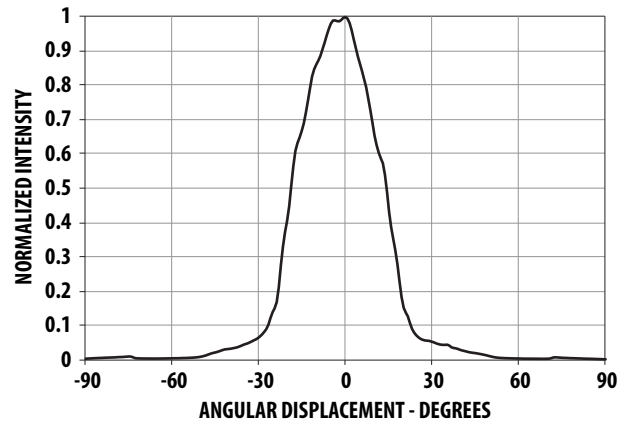

Figure 10: Relative Light Output vs. Junction Temperature

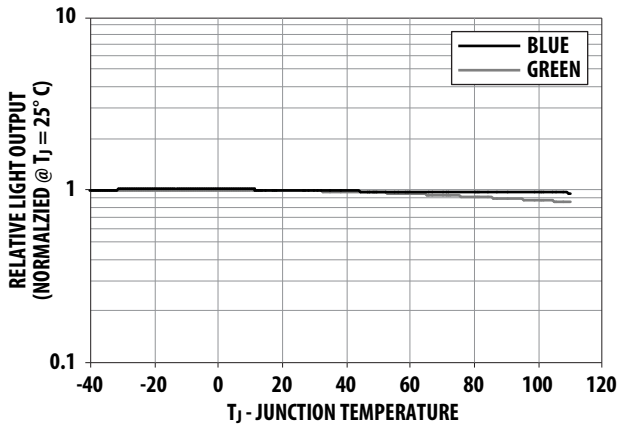
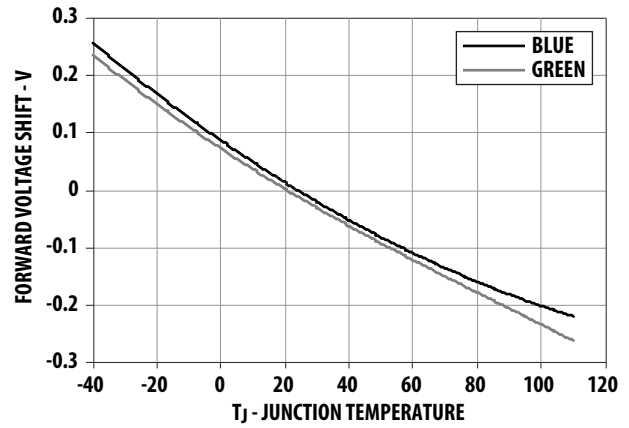

Figure 11: Forward Voltage Shift vs. Junction Temperature



Precautions

Lead Forming

- The leads of an LED lamp may be preformed or cut to length prior to insertion and soldering on PC board.
- For better control, use the proper tool to precisely form and cut the leads to applicable length rather than doing it manually.
- If manual lead cutting is necessary, cut the leads after the soldering process. The solder connection forms a mechanical ground that prevents mechanical stress due to lead cutting from traveling into LED package. Use this method for hand soldering operations, as the excess lead length also acts as a small heat sink.

Soldering and Handling

- Take care during PCB assembly and soldering process to prevent damage to the LED component.
- The LED component may be effectively hand-soldered to PCB; however, do this only under unavoidable circumstances, such as rework. The closest manual soldering distance of the soldering heat source (soldering iron's tip) to the body is 1.59 mm. Soldering the LED using soldering iron tip closer than 1.59 mm might damage the LED.



- Apply ESD precautions on the soldering station and personnel to prevent ESD damage to the LED component, which is ESD sensitive. Refer to Broadcom application note AN-1142 for details. The soldering iron used must have a grounded tip to ensure electrostatic charge is properly grounded.
- Recommended soldering condition:

	Wave Soldering ^{a, b}	Manual Solder Dipping
Pre-heat temperature	105°C max.	—
Preheat time	60s max.	—
Peak temperature	260°C max.	260°C max.
Dwell time	5s max.	5s max.

a. The above conditions refer to measurement with a thermocouple mounted at the bottom of the PCB.
 b. Use only bottom preheaters to reduce thermal stress experienced by the LED.

- Set and maintain wave soldering parameters according to the recommended temperature and dwell time. Perform a daily check on the soldering profile to ensure that it is always conforming to recommended soldering conditions.

NOTE: PCBs with different sizes and design (component density) have different heat masses (heat capacities). This might cause a change in temperature experienced by the board if the same wave soldering setting is used. Recalibrate the soldering profile again before loading a new type of PCB.

Broadcom LED Configuration

Figure 12: LED Configuration

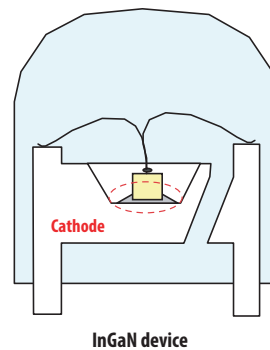

- Any alignment fixture that is applied during wave soldering must be loosely fitted and must not apply weight or force on LED. Use nonmetal material because it absorbs less heat during the wave soldering process.
- At elevated temperatures, the LED is more susceptible to mechanical stress. Therefore, allow the PCB to cool down to room temperature prior to handling, which includes removal of alignment fixture or pallet.
- If PCB board contains both through hole (TH) LED and other surface-mount components, solder the surface-mount components on the top side of the PCB. If surface mount must be on the bottom side, solder these components using reflow soldering prior to the insertion of the TH LED.

- The recommended PC board plated through holes (PTH) size for LED component leads follows.

LED Component Lead Size	Diagonal	Plated Through-Hole Diameter
0.45 × 0.45 mm (0.018 in. × 0.018 in.)	0.636 mm (0.025 inch)	0.98 mm to 1.08 mm (0.039 in. to 0.043 in.)
0.50 mm × 0.50 mm (0.020 in. × 0.020 in.)	0.707 mm (0.028 inch)	1.05 mm to 1.15 mm (0.041 in. to 0.045 in.)

- Over-sizing the PTH can lead to a twisted LED after clinching. However, undersizing the PTH can cause difficulty inserting the TH LED.

Refer to application note AN-5334 for more information about soldering and handling of high brightness TH LED lamps.

Figure 13: Example of Wave Soldering Temperature Profile for TH LED

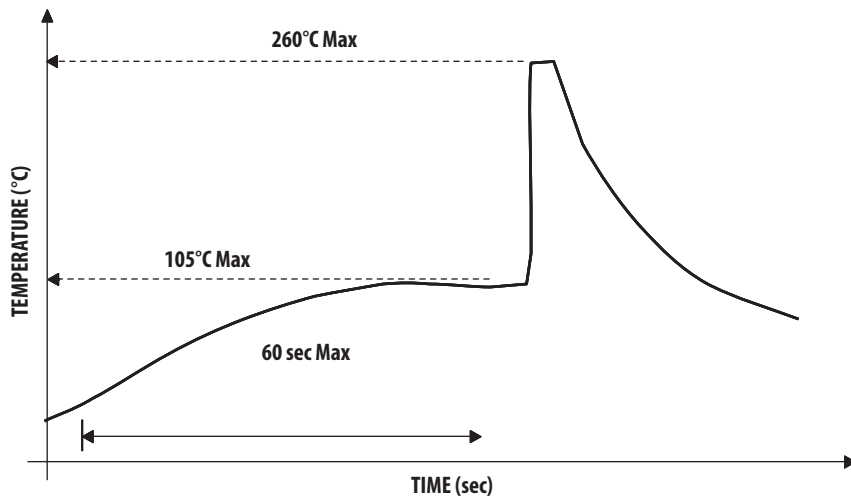

Recommended solder:
 Sn63 (Leaded solder alloy)
 SAC305 (Lead free solder alloy)

Flux: Rosin flux

Solder bath temperature: 255°C ± 5°C
 (maximum peak temperature = 260°C)

Dwell time: 3.0 sec - 5.0 sec
 (maximum = 5sec)

Note: Allow for board to be sufficiently cooled to room temperature before exerting mechanical force.

Figure 14: Ammo Packs Drawing

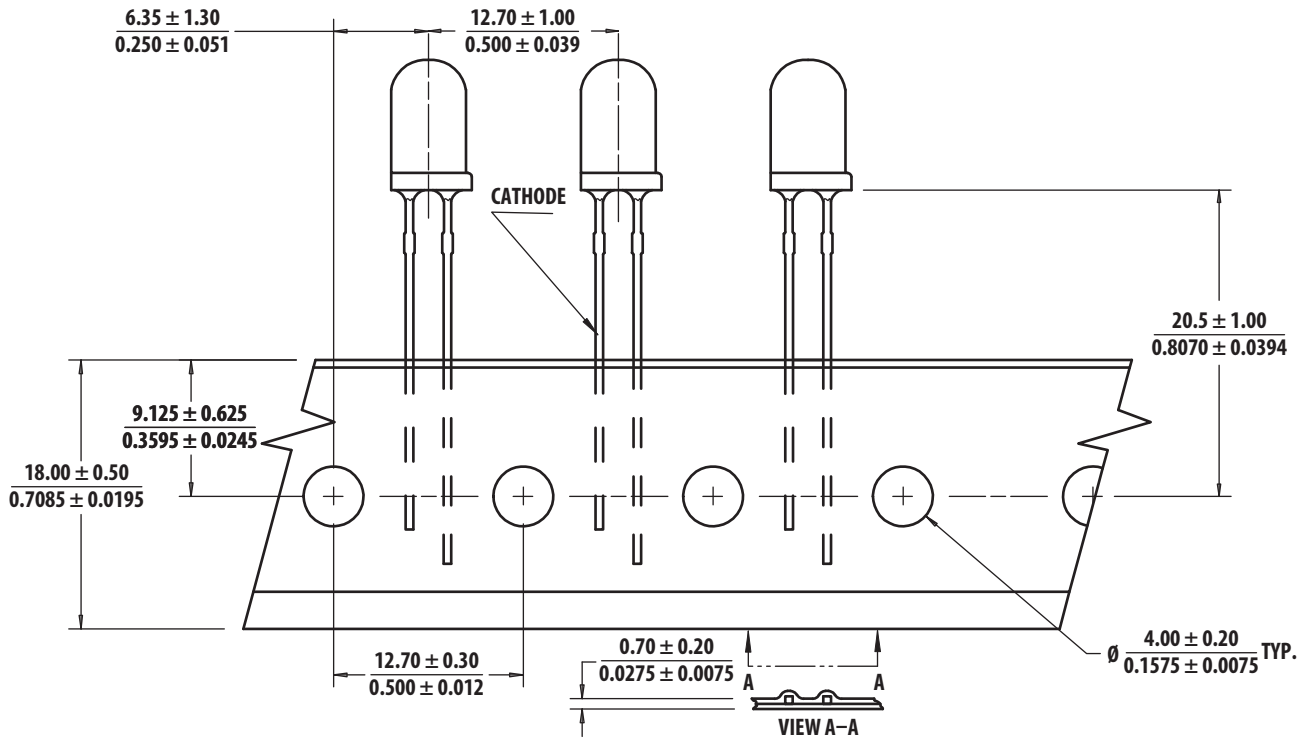

NOTE: The ammo-packs drawing is applicable for packaging option -DD and -ZZ and regardless standoff or non-standoff.

Figure 15: Packaging Box for Ammo Packs

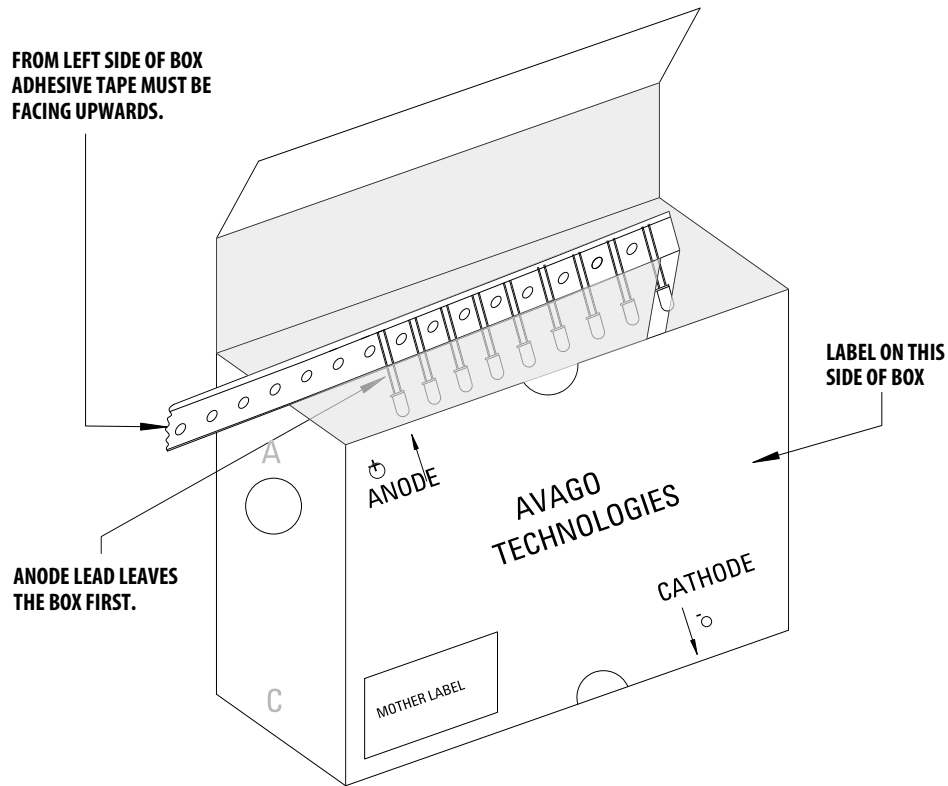

NOTE: For InGaN devices, the ammo pack packaging box contains an ESD logo.

Packaging Label

Figure 16: Mother Label (Available on packaging box of ammo pack and shipping box)











AVAGO TECHNOLOGIES	
(1P) Item: Part Number 	STANDARD LABEL LS0002 RoHS Compliant e3 max temp 260C
(1T) Lot: Lot Number 	(Q) QTY: Quantity 
LPN: 	CAT: Intensity Bin 
(9D)MFG Date: Manufacturing Date 	BIN: Color Bin
<hr/>	
(P) Customer Item: 	
(V) Vendor ID: 	(9D) Date Code: Date Code 
<hr/>	
DeptID: 	Made In: Country of Origin 

Figure 17: Baby Label (Only available on bulk packaging)

AVAGO TECHNOLOGIES	
Lamps Baby Label	
(1P) PART #: Part Number 	RoHS Compliant e3 max temp 260C
(1T) LOT #: Lot Number 	
(9D)MFG DATE: Manufacturing Date 	QUANTITY: Packing Quantity 
C/O: Country of Origin	
<hr/>	
Customer P/N: 	CAT: Intensity Bin 
Supplier Code: 	BIN: Color Bin 
	DATECODE: Date Code 

Disclaimer

Broadcom's products and software are not specifically designed, manufactured, or authorized for sale as parts, components, or assemblies for the planning, construction, maintenance, or direct operation of a nuclear facility or for use in medical devices or applications. The customer is solely responsible, and waives all rights to make claims against Broadcom or its suppliers, for all loss, damage, expense, or liability in connection with such use.

Broadcom, the pulse logo, Connecting everything, Avago Technologies, Avago, and the A logo are among the trademarks of Broadcom and/or its affiliates in the United States, certain other countries, and/or the EU.

Copyright © 2014–2018 Broadcom. All Rights Reserved.

The term "Broadcom" refers to Broadcom Limited and/or its subsidiaries. For more information, please visit www.broadcom.com.

Broadcom reserves the right to make changes without further notice to any products or data herein to improve reliability, function, or design. Information furnished by Broadcom is believed to be accurate and reliable. However, Broadcom does not assume any liability arising out of the application or use of this information, nor the application or use of any product or circuit described herein, neither does it convey any license under its patent rights nor the rights of others.



Компания «Life Electronics» занимается поставками электронных компонентов импортного и отечественного производства от производителей и со складов крупных дистрибьюторов Европы, Америки и Азии.

С конца 2013 года компания активно расширяет линейку поставок компонентов по направлению коаксиальный кабель, кварцевые генераторы и конденсаторы (керамические, пленочные, электролитические), за счёт заключения дистрибьюторских договоров

Мы предлагаем:

- Конкурентоспособные цены и скидки постоянным клиентам.
- Специальные условия для постоянных клиентов.
- Подбор аналогов.
- Поставку компонентов в любых объемах, удовлетворяющих вашим потребностям.
- Приемлемые сроки поставки, возможна ускоренная поставка.
- Доставку товара в любую точку России и стран СНГ.
- Комплексную поставку.
- Работу по проектам и поставку образцов.
- Формирование склада под заказчика.
- Сертификаты соответствия на поставляемую продукцию (по желанию клиента).
- Тестирование поставляемой продукции.
- Поставку компонентов, требующих военную и космическую приемку.
- Входной контроль качества.
- Наличие сертификата ISO.

В составе нашей компании организован Конструкторский отдел, призванный помогать разработчикам, и инженерам.

Конструкторский отдел помогает осуществить:

- Регистрацию проекта у производителя компонентов.
- Техническую поддержку проекта.
- Защиту от снятия компонента с производства.
- Оценку стоимости проекта по компонентам.
- Изготовление тестовой платы монтаж и пусконаладочные работы.



Тел: +7 (812) 336 43 04 (многоканальный)

Email: org@lifeelectronics.ru