

SAGA-HB-IP-WHT

~60° high bay beam

TECHNICAL SPECIFICATIONS:

Dimensions	Ø 50.0 mm
Height	12 mm
Fastening	screw
ROHS compliant	yes ⓘ

MATERIAL SPECIFICATIONS:

Component	Type	Material	Colour	Finish
SAGA-HB-IP	Single lens	Silicone	clear	
SAGA-FRAME-WHT	Holder	HRPC	white	

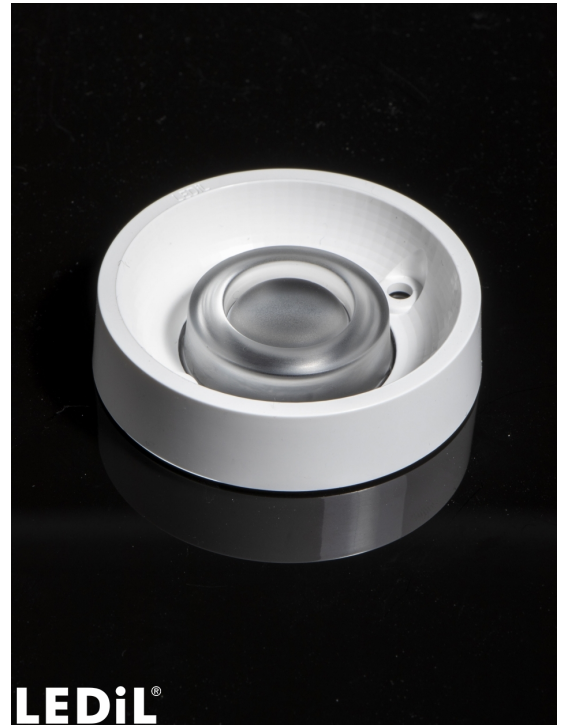

ORDERING INFORMATION:

Component	Type	Qty in box	MOQ	MPQ	Box weight (kg)
CN13990_SAGA-HB-IP-WHT » Box size: 480 x 280 x 300 mm	Single lens	520		26	0.0

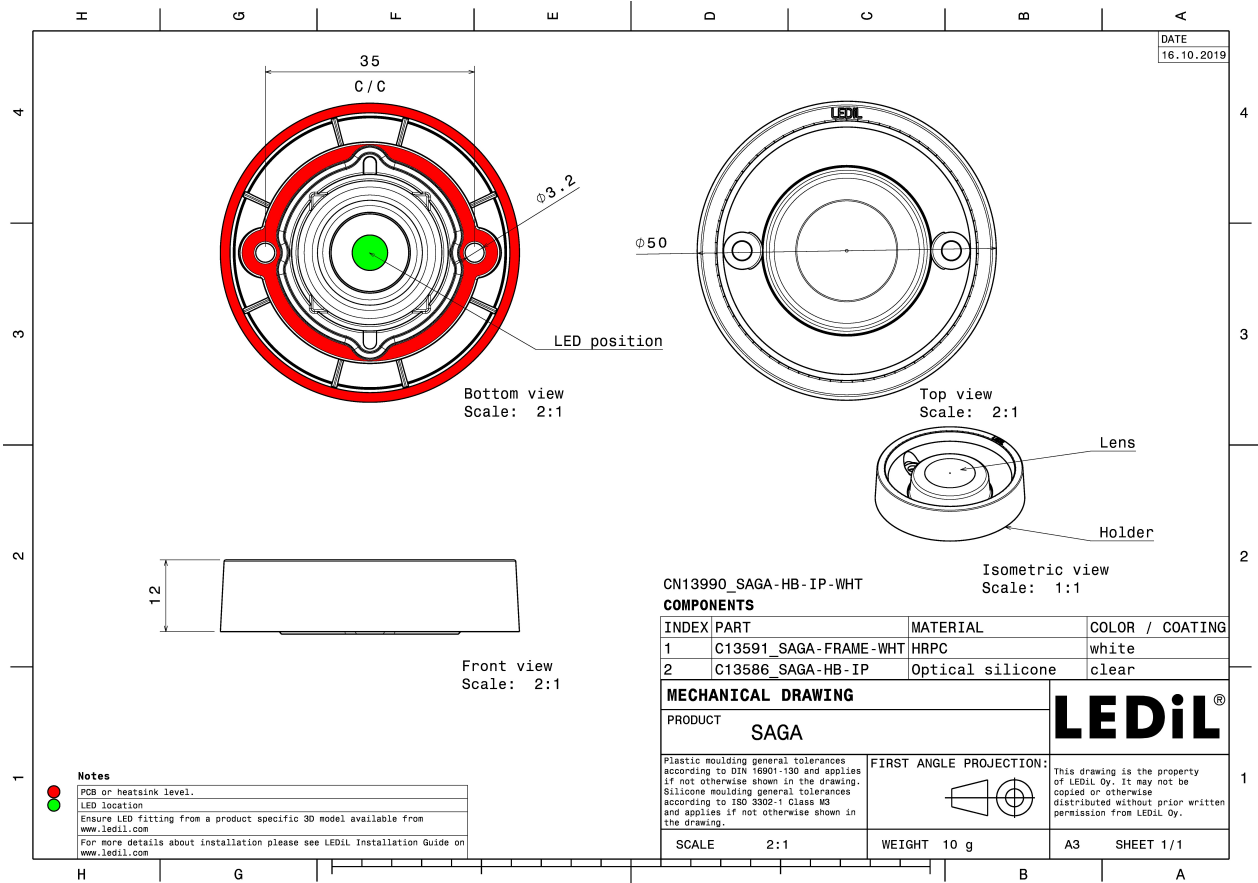

PHOTOMETRIC DATA (MEASURED):

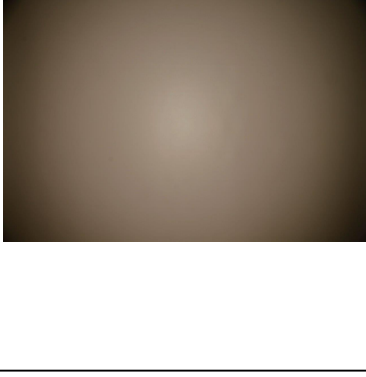
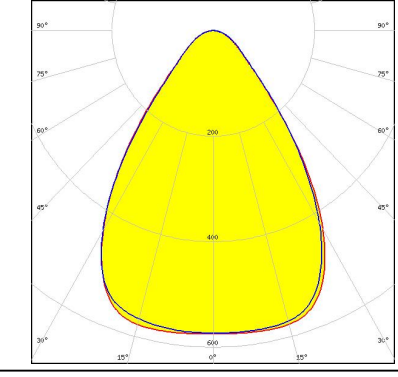
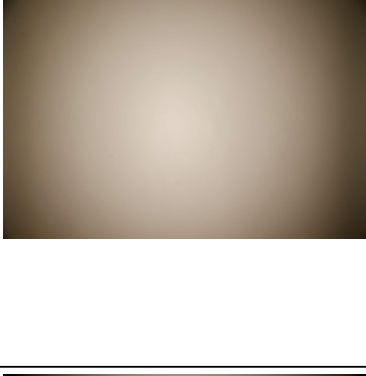
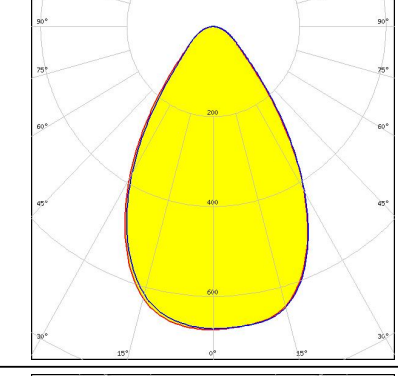
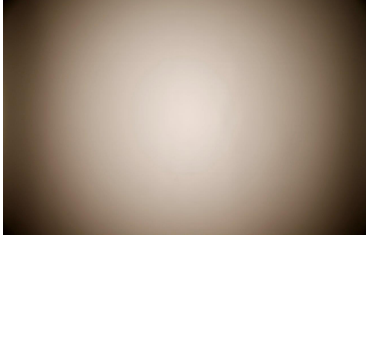
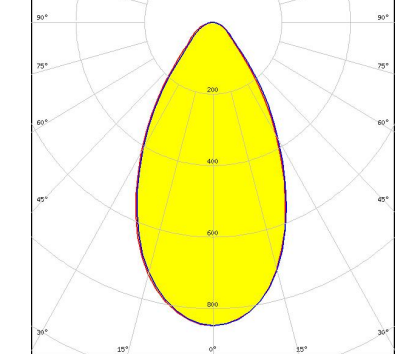
<p>bridgelux.</p> <p>LED V10 Gen6</p> <p>FWHM 58.0°</p> <p>Efficiency 89 %</p> <p>Peak intensity 0.8 cd/lm</p> <p>LEDs/each optic 1</p> <p>Light colour White</p> <p>Required components:</p>		
<p>bridgelux.</p> <p>LED V6 Gen6</p> <p>FWHM 73.0°</p> <p>Efficiency 88 %</p> <p>Peak intensity 0.6 cd/lm</p> <p>LEDs/each optic 1</p> <p>Light colour White</p> <p>Required components:</p>		
<p>bridgelux.</p> <p>LED V8 Gen6</p> <p>FWHM 66.0°</p> <p>Efficiency 88 %</p> <p>Peak intensity 0.7 cd/lm</p> <p>LEDs/each optic 1</p> <p>Light colour White</p> <p>Required components:</p>		
<p>bridgelux.</p> <p>LED VERO10</p> <p>FWHM 58.0°</p> <p>Efficiency 92 %</p> <p>Peak intensity 0.9 cd/lm</p> <p>LEDs/each optic 1</p> <p>Light colour White</p> <p>Required components:</p>		

PHOTOMETRIC DATA (MEASURED):

CITIZEN

LED CLL01x
 FWHM 61.0°
 Efficiency 92 %
 Peak intensity 0.8 cd/lm
 LEDs/each optic 1
 Light colour White
 Required components:

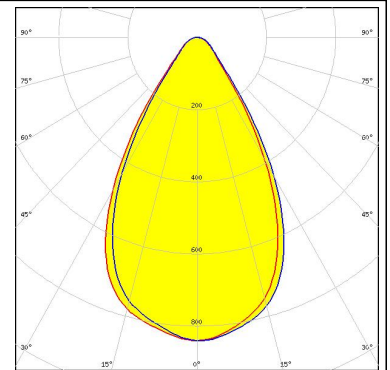

CITIZEN

LED CLL02x/CLU02x (LES10)
 FWHM 58.0°
 Efficiency 91 %
 Peak intensity 0.9 cd/lm
 LEDs/each optic 1
 Light colour White
 Required components:

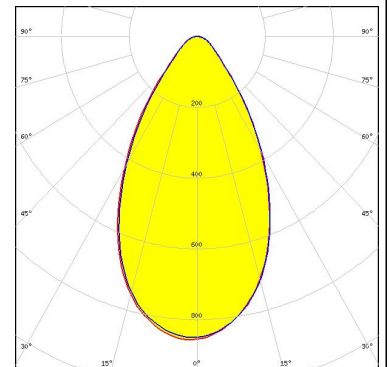
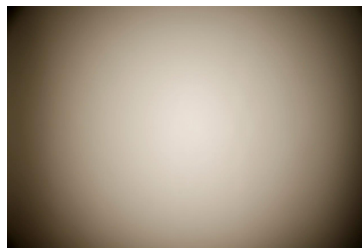

CITIZEN

LED CLL02x/CLU02x (LES10)
 FWHM 47.0°
 Efficiency 86 %
 Peak intensity 1 cd/lm
 LEDs/each optic 1
 Light colour White
 Required components:
 Bender Wirth: 434 Typ L6

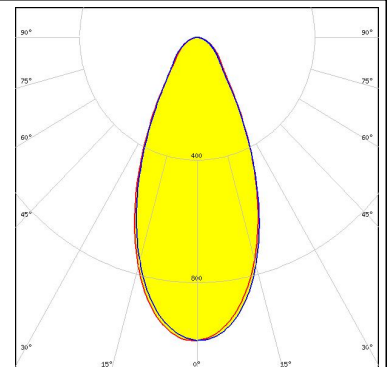
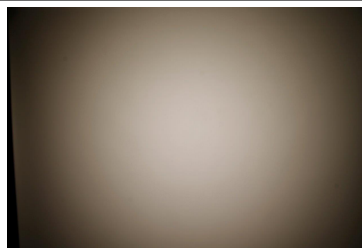

CITIZEN

LED CLL03x/CLU03x
 FWHM 64.0°
 Efficiency 92 %
 Peak intensity 0.7 cd/lm
 LEDs/each optic 1
 Light colour White
 Required components:

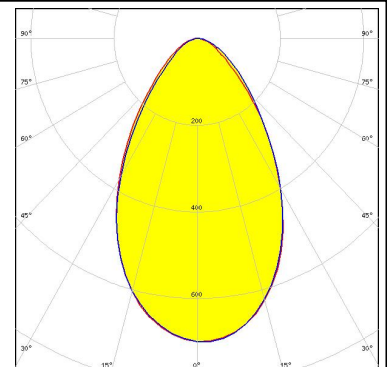
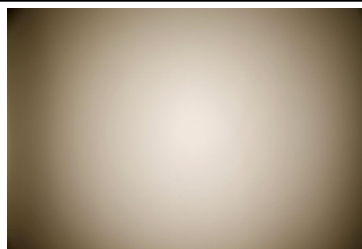

PHOTOMETRIC DATA (MEASURED):

CITIZEN

LED CLL03x/CLU03x
 FWHM 61.0°
 Efficiency 84 %
 Peak intensity 0.6 cd/lm
 LEDs/each optic 1
 Light colour White
 Required components:
 Bender Wirth: 433 Typ L6

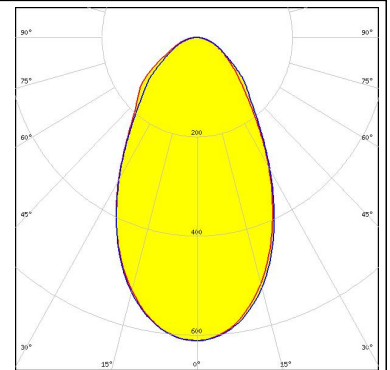
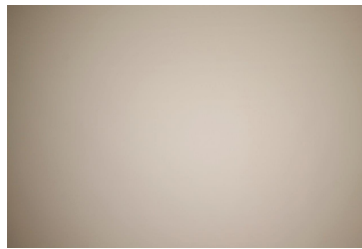

CITIZEN

LED CLU700/701/702
 FWHM 56.0°
 Efficiency 87 %
 Peak intensity 0.9 cd/lm
 LEDs/each optic 1
 Light colour White
 Required components:

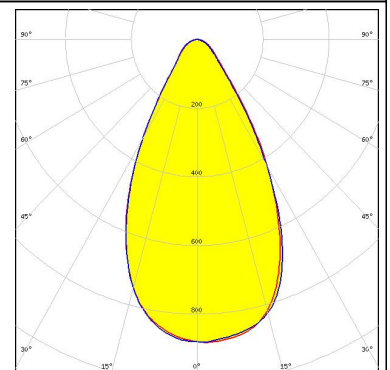
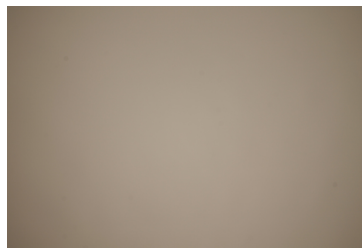

CITIZEN

LED CLU700/701/702
 FWHM 46.0°
 Efficiency 86 %
 Peak intensity 1.1 cd/lm
 LEDs/each optic 1
 Light colour White
 Required components:
 Bender Wirth: 434 Typ L6

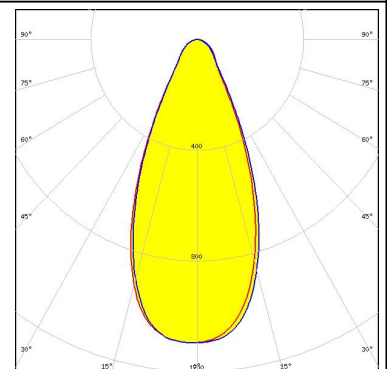
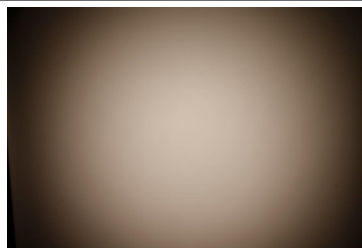

CITIZEN

LED CLU710/711
 FWHM 62.0°
 Efficiency 90 %
 Peak intensity 0.7 cd/lm
 LEDs/each optic 1
 Light colour White
 Required components:

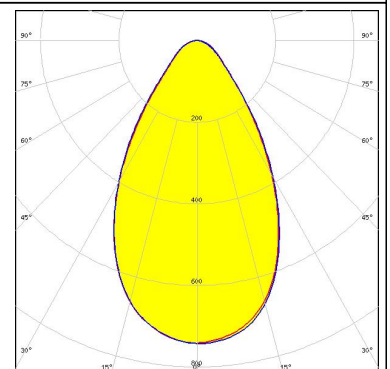
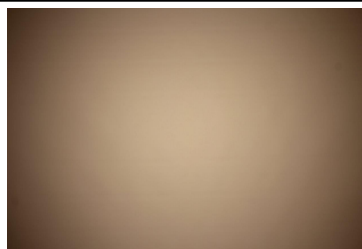

PHOTOMETRIC DATA (MEASURED):

CITIZEN

LED CLU720/721
 FWHM 61.0°
 Efficiency 89 %
 Peak intensity 0.7 cd/lm
 LEDs/each optic 1
 Light colour White
 Required components:

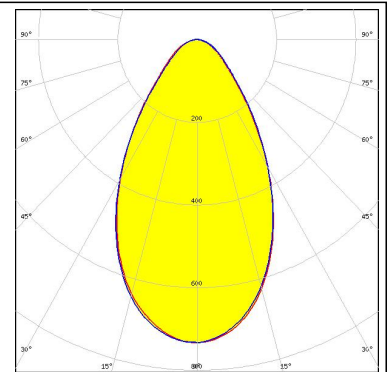
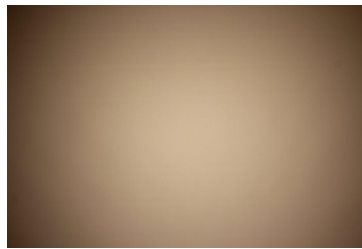

CITIZEN

LED CLU720/721
 FWHM 50.0°
 Efficiency 85 %
 Peak intensity 0.9 cd/lm
 LEDs/each optic 1
 Light colour White
 Required components:
 Bender Wirth: 433 Typ L6

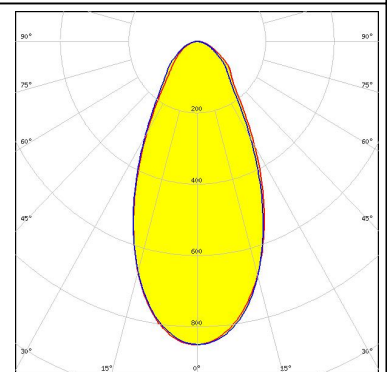
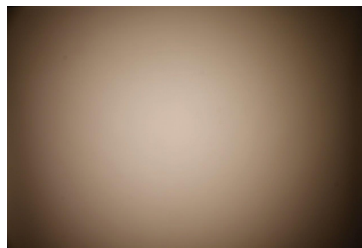

CREE

LED CXA/B 13xx
 FWHM 70.0°
 Efficiency 92 %
 Peak intensity 0.7 cd/lm
 LEDs/each optic 1
 Light colour White
 Required components:

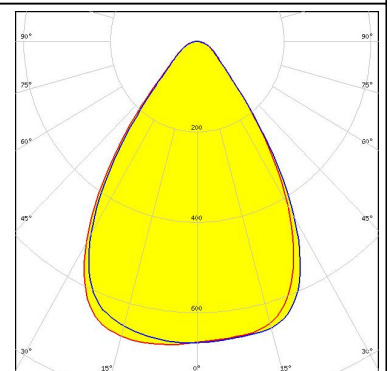
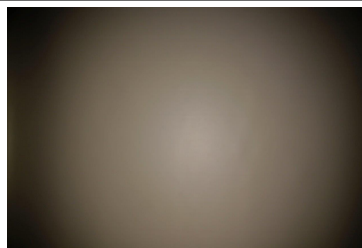

CREE

LED CXA/B 15xx
 FWHM 64.0°
 Efficiency 92 %
 Peak intensity 0.8 cd/lm
 LEDs/each optic 1
 Light colour White
 Required components:

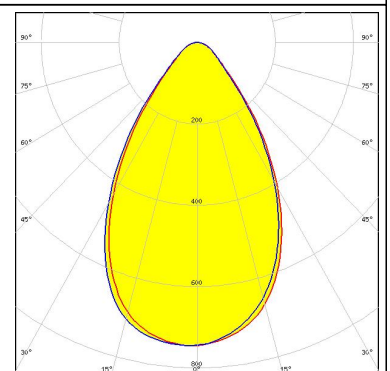
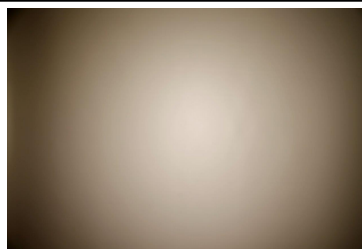

PHOTOMETRIC DATA (MEASURED):

CREE

LED CXA/B 15xx
 FWHM 64.0°
 Efficiency 90 %
 Peak intensity 0.8 cd/lm
 LEDs/each optic 1
 Light colour White
 Required components:

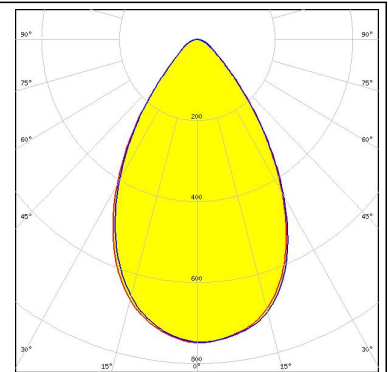
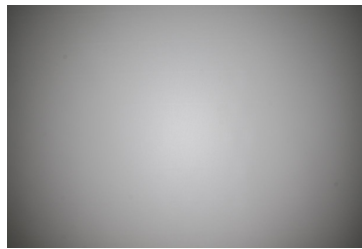

CREE

LED CXA/B 1816 & CXA/B 1820 & CXA 1850
 FWHM 63.0°
 Efficiency 90 %
 Peak intensity 0.7 cd/lm
 LEDs/each optic 1
 Light colour White
 Required components:

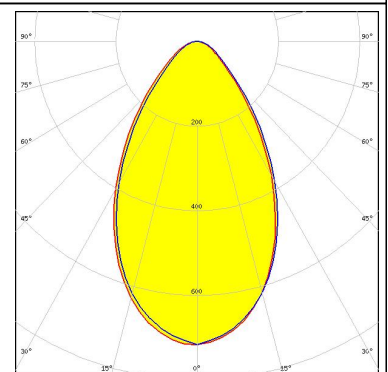
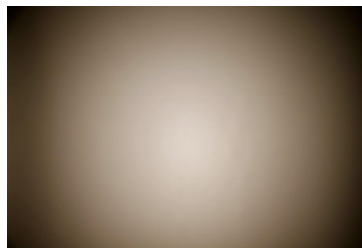

CREE

LED MHD-E/G
 FWHM 60.0°
 Efficiency 90 %
 Peak intensity 0.8 cd/lm
 LEDs/each optic 1
 Light colour White
 Required components:

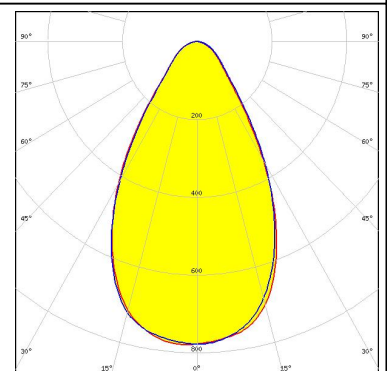
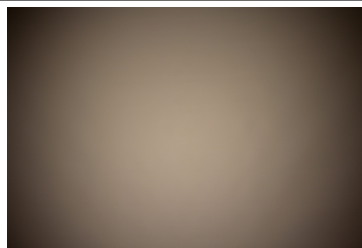

LUMILEDS

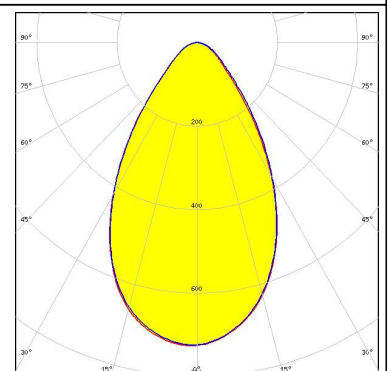
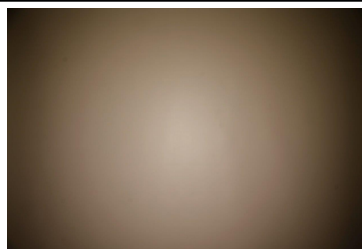

LED LUXEON CoB 1202/1203
 FWHM 63.0°
 Efficiency 89 %
 Peak intensity 0.7 cd/lm
 LEDs/each optic 1
 Light colour White
 Required components:

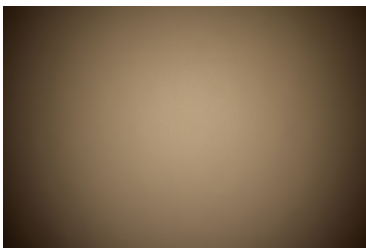
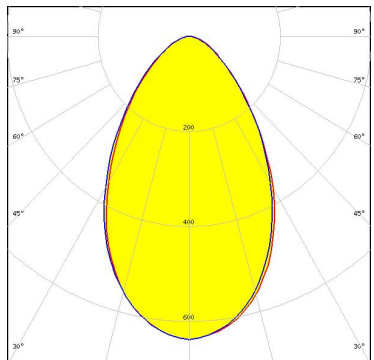
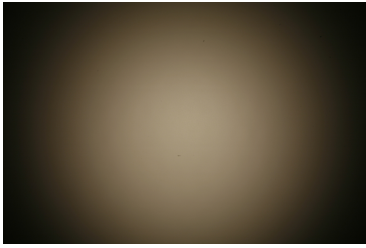
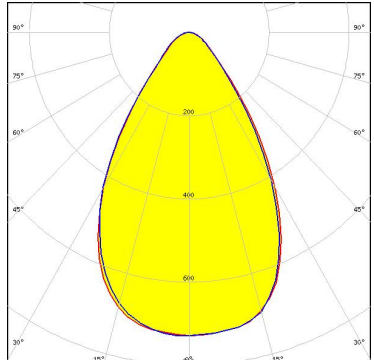
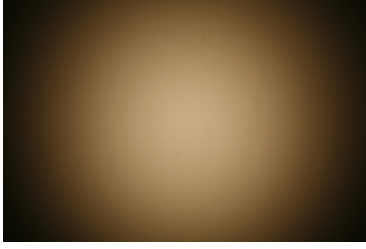
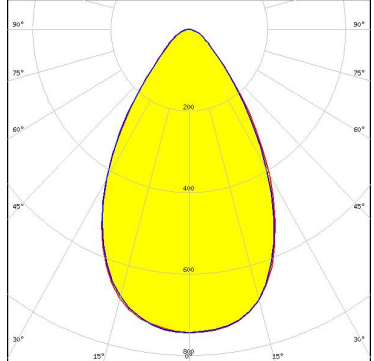

PHOTOMETRIC DATA (MEASURED):

<p>LUMILEDS</p> <p>LED LUXEON CoB 1202s FWHM 67.0° Efficiency 90 % Peak intensity 0.7 cd/lm LEDs/each optic 1 Light colour White Required components:</p>		
<p>LUMINUS</p> <p>LED CxM-14 (19x19) FWHM 66.0° Efficiency 88 % Peak intensity 0.6 cd/lm LEDs/each optic 1 Light colour White Required components:</p>		
<p>LUMINUS</p> <p>LED CxM-6 (12x13) FWHM 66.0° Efficiency 89 % Peak intensity 0.7 cd/lm LEDs/each optic 1 Light colour White Required components:</p>		
<p>LUMINUS</p> <p>LED CXM-7 (13x13) FWHM 64.0° Efficiency 89 % Peak intensity 0.8 cd/lm LEDs/each optic 1 Light colour White Required components:</p>		

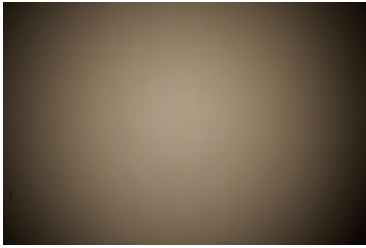
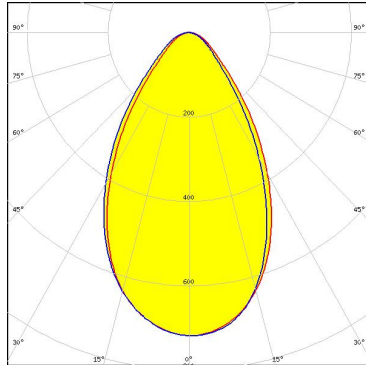
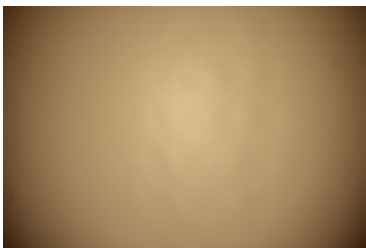
PHOTOMETRIC DATA (MEASURED):

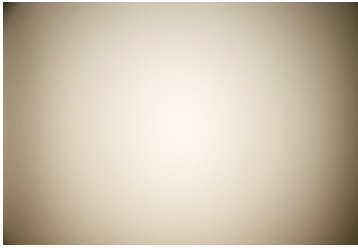
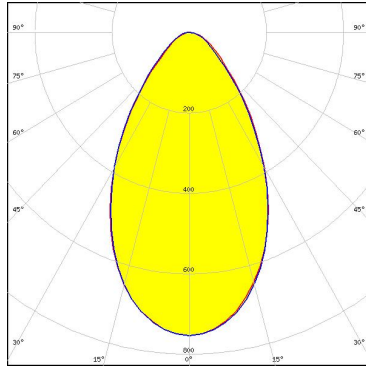
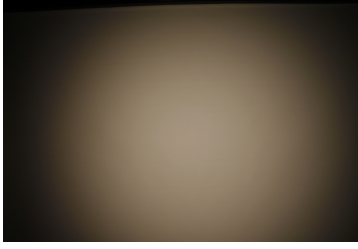
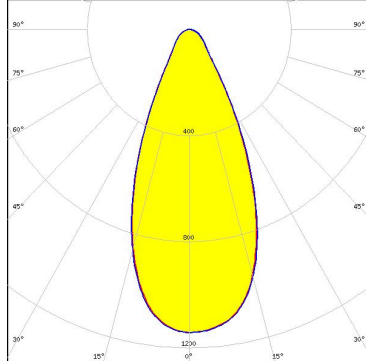
<p>LUMINUS</p> <p>LED CxM-9 (13.5x13.5) FWHM 63.0° Efficiency 88 % Peak intensity 0.7 cd/lm LEDs/each optic 1 Light colour White Required components:</p>		
<p>OSRAM Opto Semiconductors</p> <p>LED Duris S10 FWHM 74.0° Efficiency 91 % Peak intensity 0.7 cd/lm LEDs/each optic 1 Light colour White Required components:</p>		
<p>OSRAM Opto Semiconductors</p> <p>LED Soleriq S13 FWHM 61.0° Efficiency 91 % Peak intensity 0.8 cd/lm LEDs/each optic 1 Light colour White Required components:</p>		
<p>SEOUL SEMICONDUCTOR</p> <p>LED MJT COB LES 6 FWHM 46.0° Efficiency 87 % Peak intensity 1.1 cd/lm LEDs/each optic 1 Light colour White Required components: Bender Wirth: 434 Typ L6</p>		

PHOTOMETRIC DATA (MEASURED):

SHARP

LED Mini Zenigata (GW6BM)
FWHM 62.0°
Efficiency 92 %
Peak intensity 0.8 cd/lm
LEDs/each optic 1
Light colour White
Required components:

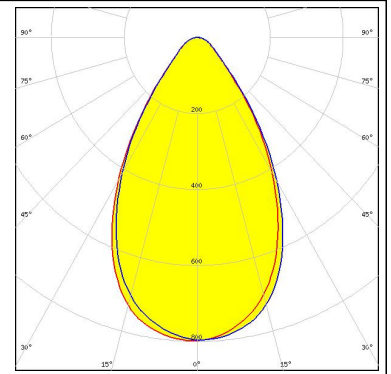
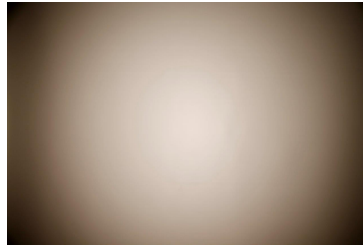

PHOTOMETRIC DATA (SIMULATED):

LUMILEDS

LED LUXEON CoB Compact
FWHM 67.0°
Efficiency 90 %
Peak intensity 0.7 cd/lm
LEDs/each optic 1
Light colour White
Required components:

LUMINUS

LED CxM-14 (19x19)
FWHM 61.0°
Efficiency 84 %
Peak intensity 0.6 cd/lm
LEDs/each optic 1
Light colour White
Required components:
Bender Wirth: 433 Typ L6

LUMINUS

LED CxM-9 (13.5x13.5)
FWHM 47.0°
Efficiency 86 %
Peak intensity 1 cd/lm
LEDs/each optic 1
Light colour White
Required components:
Bender Wirth: 434 Typ L6

NICHIA

LED NCSU334A
FWHM 62.0°
Efficiency 76 %
LEDs/each optic 1
Light colour UV
Required components:

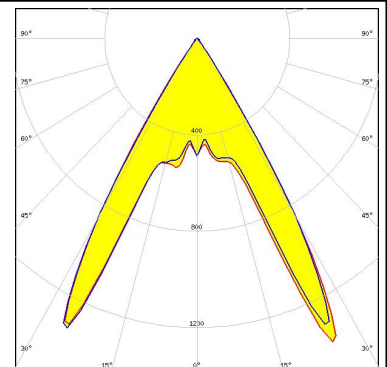

PHOTOMETRIC DATA (SIMULATED):

OSRAM

Opto Semiconductors

LED Soleriq S9
FWHM 56.0°
Efficiency 93 %
Peak intensity 1.1 cd/lm
LEDs/each optic 1
Light colour White
Required components:

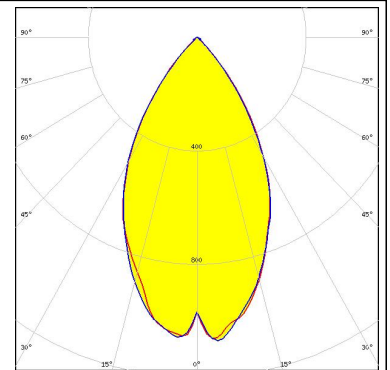

SAMSUNG

LED LC020C
FWHM 42.0°
Efficiency 87 %
Peak intensity 1.6 cd/lm
LEDs/each optic 1
Light colour White
Required components:
Bender Wirth: 479 Typ L6

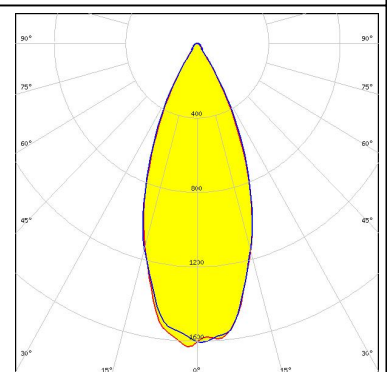

SAMSUNG

LED LC040C
FWHM 51.0°
Efficiency 87 %
Peak intensity 1.1 cd/lm
LEDs/each optic 1
Light colour White
Required components:
Bender Wirth: 480 Typ L6

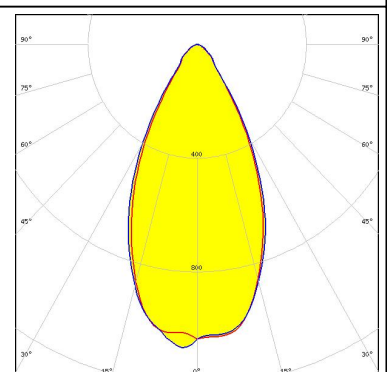

SEOUL SEMICONDUCTOR

LED ZC12/18
FWHM 61.0°
Efficiency 84 %
Peak intensity 0.6 cd/lm
LEDs/each optic 1
Light colour White
Required components:
Bender Wirth: 433 Typ L6

PHOTOMETRIC DATA (SIMULATED):

	
SEOUL SEMICONDUCTOR	
LED	ZC4/6
FWHM	47.0°
Efficiency	86 %
Peak intensity	1 cd/lm
LEDs/each optic	1
Light colour	White
Required components:	
Bender Wirth: 434 Typ L6	

GENERAL INFORMATION:

NOTE: The typical beam angle will be changed by different color, chip size and chip position tolerance. The typical total beam angle is the full angle measured where the luminous intensity is half of the peak value.

Due to use of high power COB's with this product, special attention to proper thermal design is highly recommended. LEDiL has no liability for direct, indirect or consecutive damages arising from the LEDiL products being used outside of the recommended temperature range.

MATERIALS:

As part of our continuous research and improvement processes, and to ensure the best possible quality and availability of our products, LEDiL reserves the right to change material grades without notice.

PRODUCT DATA USER AGREEMENT AND DISCLAIMER:

The measured data in the provided downloadable LEDiL Product Datasheets and Mechanical 2D-Drawings is rounded and provided as reference for planning. LEDiL Oy's optical specifications have been verified by conducting performance testing of the products in accordance with the company's quality system. The reported data are averaged results of multiple measurements with typical variation. LEDiL Oy reserves the right to without prior notification make changes and improvements to its products.

LEDiL Oy assumes neither warranty, nor guarantee nor any other liability of any kind for the contents and correctness of the provided data. The provided data has been generated with highest diligence but the provided data may in reality not represent the complete possible variation range of all intrinsic parameters. Therefore, in certain cases a deviation from the provided data could occur.

LEDiL Oy reserves the right to undertake technical changes of its products without further notification which could lead to changes in the provided data. LEDiL Oy assumes no liability of any kind for the possible deviation from any provided data or any other damage resulting from the usage of the provided data.

The user agrees to this disclaimer and user agreement with the download or usage of the provided files.

LEDiL Oy

Joensuunkatu 13
FI-24240 SALO
Finland

LEDiL Inc.

228 West Page Street
Suite D
Sycamore IL 60178
USA

Local sales and technical support

www.ledil.com/where_to_buy

Shipping locations

Salo, Finland
Hong Kong, China

Distribution Partners

www.ledil.com/where_to_buy

Компания «Life Electronics» занимается поставками электронных компонентов импортного и отечественного производства от производителей и со складов крупных дистрибьюторов Европы, Америки и Азии.

С конца 2013 года компания активно расширяет линейку поставок компонентов по направлению коаксиальный кабель, кварцевые генераторы и конденсаторы (керамические, пленочные, электролитические), за счёт заключения дистрибьюторских договоров

Мы предлагаем:

- Конкурентоспособные цены и скидки постоянным клиентам.
- Специальные условия для постоянных клиентов.
- Подбор аналогов.
- Поставку компонентов в любых объемах, удовлетворяющих вашим потребностям.
- Приемлемые сроки поставки, возможна ускоренная поставка.
- Доставку товара в любую точку России и стран СНГ.
- Комплексную поставку.
- Работу по проектам и поставку образцов.
- Формирование склада под заказчика.
- Сертификаты соответствия на поставляемую продукцию (по желанию клиента).
- Тестирование поставляемой продукции.
- Поставку компонентов, требующих военную и космическую приемку.
- Входной контроль качества.
- Наличие сертификата ISO.

В составе нашей компании организован Конструкторский отдел, призванный помогать разработчикам, и инженерам.

Конструкторский отдел помогает осуществить:

- Регистрацию проекта у производителя компонентов.
- Техническую поддержку проекта.
- Защиту от снятия компонента с производства.
- Оценку стоимости проекта по компонентам.
- Изготовление тестовой платы монтаж и пусконаладочные работы.



Тел: +7 (812) 336 43 04 (многоканальный)
Email: org@lifeelectronics.ru