

HA1631D01/02/03/04 Series

Dual CMOS Comparator (Push Pull/Open Drain Output)

REJ03D0804-0200

Rev.2.00

Nov 20, 2006

Description

The HA1631D01/02/03/04 are low power dual CMOS Comparator featuring low voltage operation with typical current supply of 10 μ A/100 μ A. They are designed to operate from a single power supply and have push-pull full swing outputs that allow direct connections to logic devices. The Open Drain version HA1631D03/04 enable Output Level shifting through external pull up resistors. Available in MMPAK-8 and TSSOP-8 package.

Features

- Low supply current
 HA1631D01/03 : $I_{DDtyp} = 5 \mu A$ (per comparators)
 HA1631D02/04 : $I_{DDtyp} = 50 \mu A$ (per comparators)
- Low voltage operation : $V_{DD} = 1.8$ to 5.5 V
- Low input offset voltage : $V_{IOmax} = 5$ mV
- Low input bias current : $I_{IBtyp} = 1$ pA
- Maximum output voltage : $V_{OHmin} = 2.9$ V (at $V_{DD} = 3.0$ V)
- Input common voltage range includes ground
- On-chip ESD protection
- Available in MMPAK-8, TSSOP-8 package using Pb free lead frame

Ordering Information

Type No.	Package Name	Package Code
HA1631D01T	TTP-8DAV	PTSP0008JC-B
HA1631D02T		
HA1631D03T		
HA1631D04T		
HA1631D01MM	MMPAK-8	PLSP0008JC-A
HA1631D02MM		
HA1631D03MM		
HA1631D04MM		

Pin Arrangement

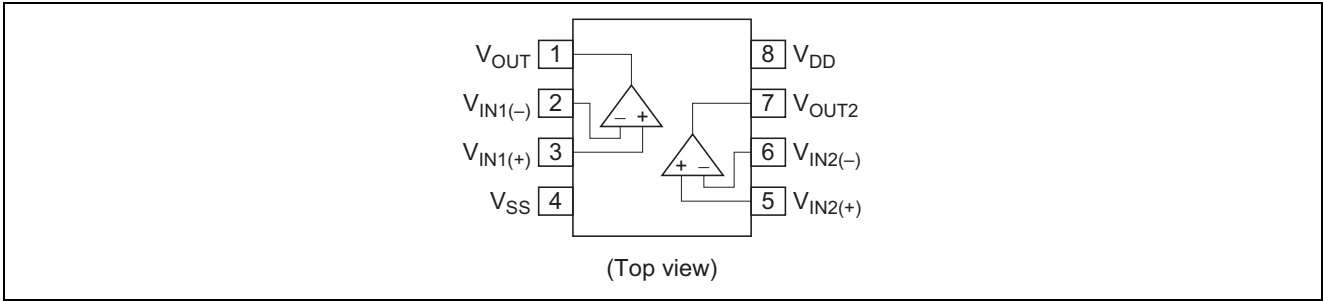

Equivalent Circuit (1/2)

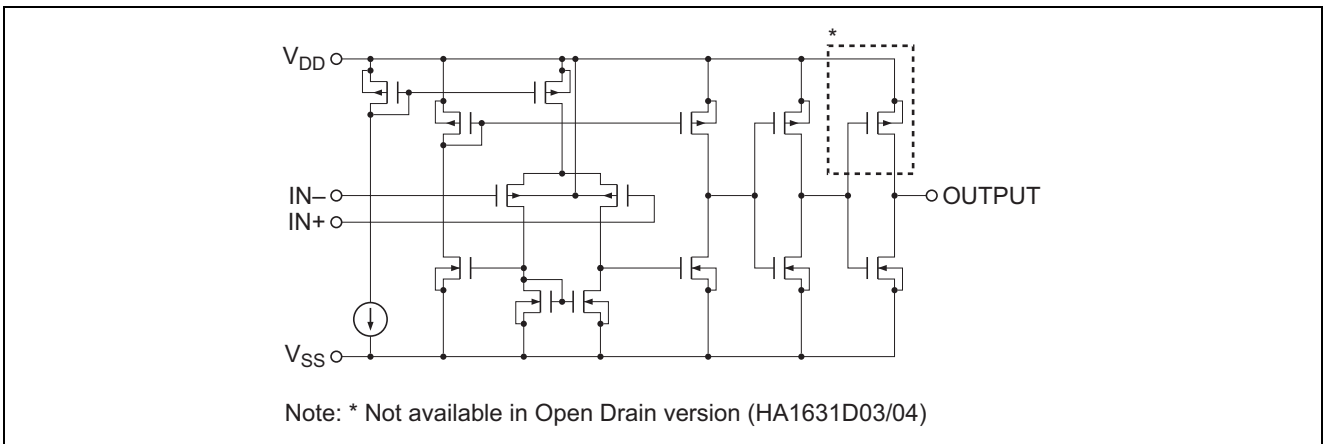

Absolute Maximum Ratings

(Ta = 25°C)

Item	Symbol	Ratings	Unit	Remarks
Supply voltage	V _{DD}	7.0	V	
Differential input voltage	V _{IN(diff)}	-V _{DD} to +V _{DD}	V	Note 1
Input voltage	V _{IN}	-0.1 to +V _{DD}	V	
Output current	I _{OUT}	28	mA	Note 2
Power dissipation	P _T	192	mW	TSSOP-8
Operating temperature	T _{opr}	-40 to +85	°C	
Storage temperature	T _{stg}	-55 to +125	°C	

Notes: 1. Do not apply input voltage exceeding V_{DD} or 7 V.

2. The maximum output current is the maximum allowable value for continuous operation.

Electrical Characteristics

(Ta = 25°C, V_{DD} = 3.0 V, V_{SS} = 0 V)

Item	Symbol	Min	Typ	Max	Unit	Test Conditions	
Input offset voltage	V _{IO}	—	—	5	mV	V _{IN} = V _{DD} /2, R _L = 1 MΩ	
Input bias current	I _{IB}	—	(1)	—	pA	V _{IN} = V _{DD} /2	
Input offset current	I _{IO}	—	(1)	—	pA	V _{IN} = V _{DD} /2	
Common mode input voltage range	V _{CM}	-0.1	—	2.1	V		
Supply current	HA1631D01/03	I _{DD}	—	10	20	μA	V _{DD} = 3 V, V _{IN+} = 1 V, V _{IN-} = 0 V
	HA1631D02/04		—	100	200	μA	
Response time	HA1631D01	TP _{LH}	—	(1.20)	—	μs	1 V DC bias, 100 mV overdrive, C _L = 15 pF
	HA1631D01/03	TP _{HL}	—	(0.55)	—	μs	
	HA1631D01	t _r	—	(24)	—	ns	
	HA1631D01/03	t _f	—	(7)	—	ns	
	HA1631D02	TP _{LH}	—	(0.33)	—	μs	
	HA1631D02/04	TP _{HL}	—	(0.17)	—	μs	
	HA1631D02	t _r	—	(12)	—	ns	
Output source current (Only for HA1631D01/02)	I _{OSOURCE}	6	13	—	mA	V _{out} = 2.5 V	
		7	14	—	mA	V _{out} = 0.5 V	
Common mode rejection ratio	HA1631D01/03	CMRR	60	80	—	dB	V _{IN1} = 0 V, V _{IN2} = 2 V
	HA1631D02/04		50	70	—	dB	
Power supply rejection ratio	PSRR	60	80	—	dB	V _{DD1} = 1.8 V, V _{DD2} = 5 V	
Output voltage high (Only for HA1631D01/02)	V _{OH}	V _{DD} -0.1	—	—	V	R _L = 10 kΩ to V _{SS}	
Output voltage low	V _{OL}	—	—	0.1	V	R _L = 10 kΩ to V _{DD}	
Output leakage current (Only for HA1631D03/04)	I _{LO}	—	—	0.1	μA	V _{IN+} = 1 V, V _{IN-} = 0 V, V _O = 3 V	
Operating voltage range	V _{opr}	1.8	—	5.5	V		

Note: (): Design specification

Table of Graphs

Electrical Characteristics			HA1631D01 Figure	HA1631D02 Figure	HA1631D03 Figure	HA1631D04 Figure	Test Circuit No.
Supply current	I_{DD}	vs. Supply voltage(Out H)	1-1	2-1	3-1	4-1	1
		vs. Supply voltage(Out L)	1-2	2-2	3-2	4-2	2
		vs. Temperature(Out H)	1-3	2-3	3-3	4-3	1
		vs. Frequency(Out H)	1-26	2-26	3-20	4-20	15
Output high voltage	V_{OH}	vs. Rload	1-19	2-19	—	—	4
Output source current	I_{SOURCE}	vs. Output high voltage	1-4	2-4	—	—	3
Output low voltage	V_{OL}	vs. Rload	1-18	2-18	3-15	4-15	6
Output sink current	I_{OSINK}	vs. Output low voltage	1-5	2-5	3-4	4-4	5
Input offset voltage	V_{IO}	vs. Supply voltage	1-6	2-6	3-5	4-5	8
		vs. Temperature	1-7	2-7	3-6	4-6	7
Common mode input voltage range	V_{CM}	vs. Temperature	1-8	2-8	3-7	4-7	9
Power supply rejection ratio	PSRR	vs. Supply voltage	1-9	2-9	3-8	4-8	11
Common mode rejection ratio	CMRR	vs. Input voltage	1-10	2-10	3-9	4-9	12
Input bias current	I_{IB}	vs. Temperature	1-11	2-11	3-10	4-10	10
		vs. Input voltage($V_{DD} = 3\text{ V}$)	1-12	2-12	3-11	4-11	10
		vs. Input voltage($V_{DD} = 7\text{ V}$)	1-13	2-13	3-12	4-12	10
Falling time	t_f	vs. Temperature	1-14	2-14	3-13	4-13	13
		vs. Cload	1-16	2-16	3-14	4-14	13
		Time waveform	1-21	2-21	3-16	4-16	13
Rising time	t_r	vs. Temperature	1-15	2-15	—	—	13
		vs. Cload	1-17	2-17	—	—	13
		Time waveform	1-20	2-20	—	—	13
Propagation delay time	TP_{LH}	Time waveform	1-22	2-22	—	—	13
	TP_{HL}	Time waveform	1-23	2-23	3-17	4-17	13
Cross talk	$V_{OUT}(CH1)$	vs. Input voltage	1-24	2-24	3-18	4-18	14
	$V_{OUT}(CH2)$	vs. Input voltage	1-25	2-25	3-19	4-19	14

Main Characteristics

(unless otherwise noted, $V_{DD} = 3\text{ V}$, $V_{SS} = 0\text{ V}$, $T_a = 25^\circ\text{C}$)

Figure 1-1 HA1631D01
Supply Current vs. Supply Voltage
(Output High)

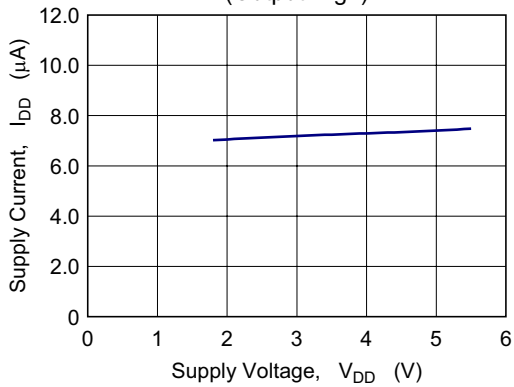

Figure 1-2 HA1631D01
Supply Current vs. Supply Voltage
(Output Low)

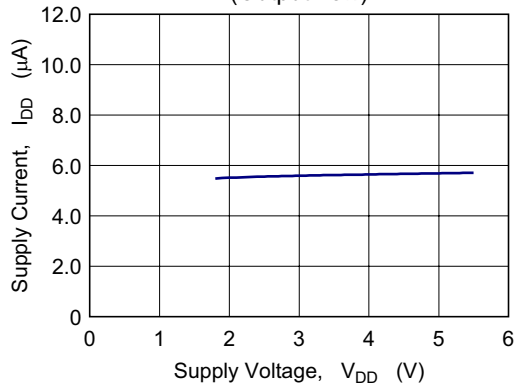

Figure 1-3 HA1631D01
Supply Current vs. Ambient Temperature

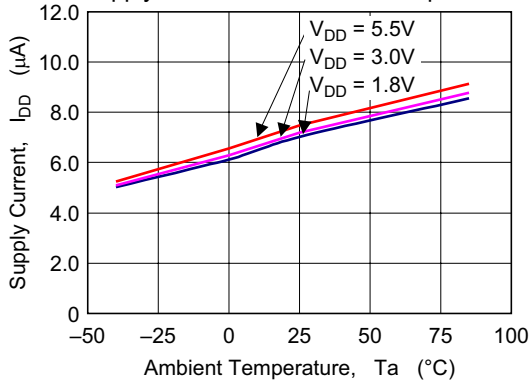

Figure 1-4 HA1631D01
Output High Voltage vs. Output Source Current

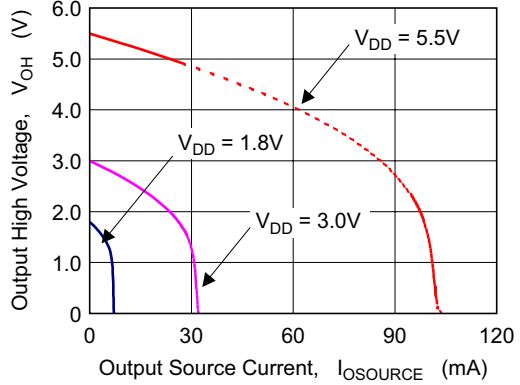

Figure 1-5 HA1631D01
Output Low Voltage vs. Output Sink Current

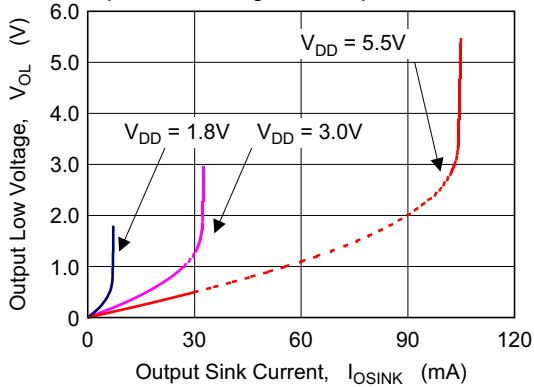
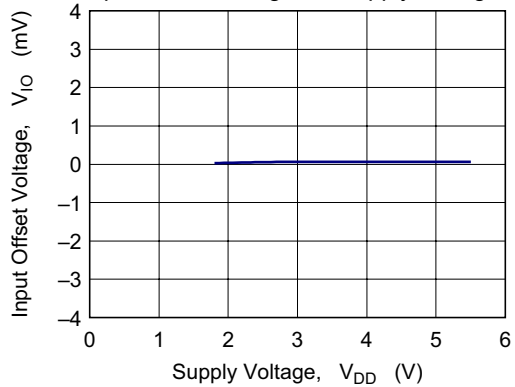
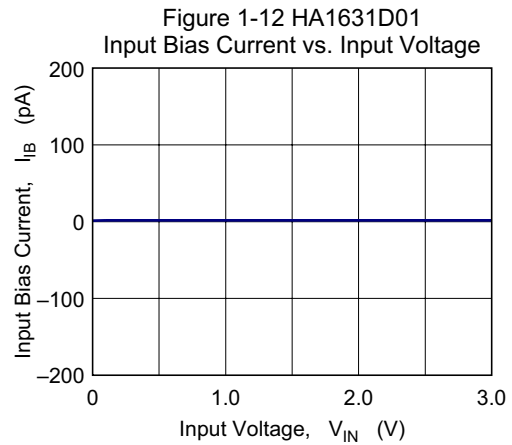
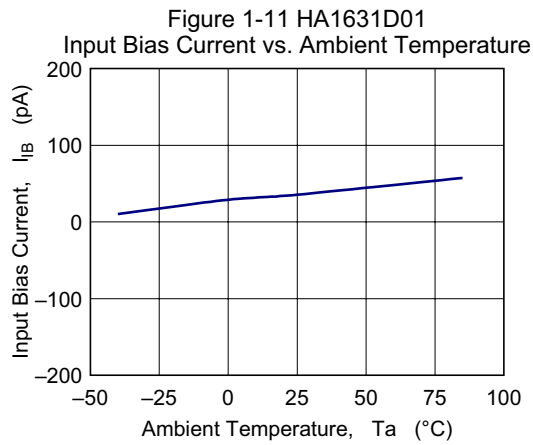
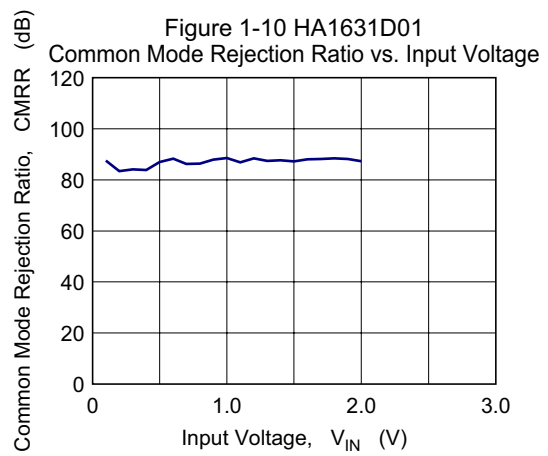
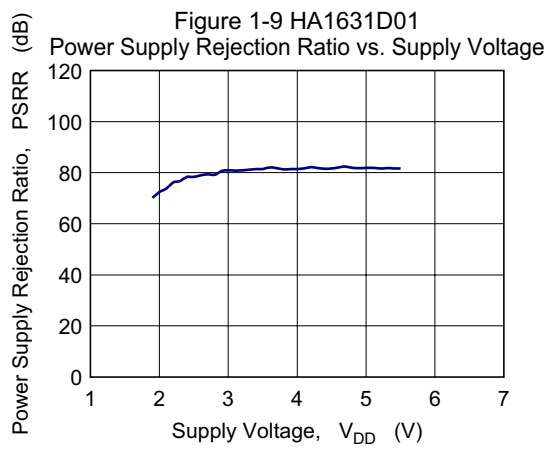
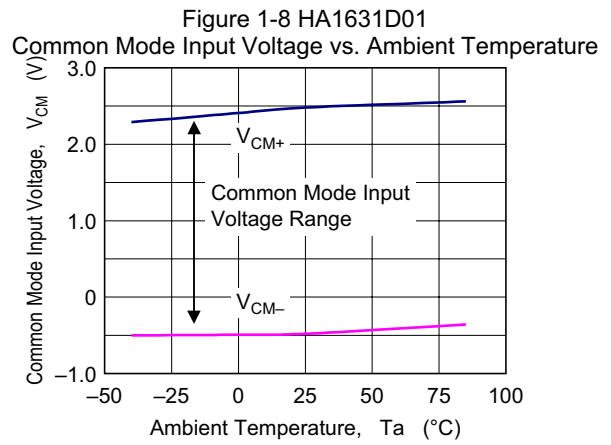
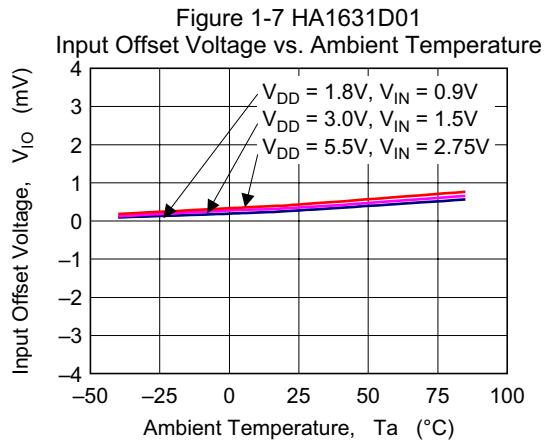

Figure 1-6 HA1631D01
Input Offset Voltage vs. Supply Voltage



(unless otherwise noted, $V_{DD} = 3\text{ V}$, $V_{SS} = 0\text{ V}$, $T_a = 25^\circ\text{C}$)



(unless otherwise noted, $V_{DD} = 3\text{ V}$, $V_{SS} = 0\text{ V}$, $T_a = 25^\circ\text{C}$)

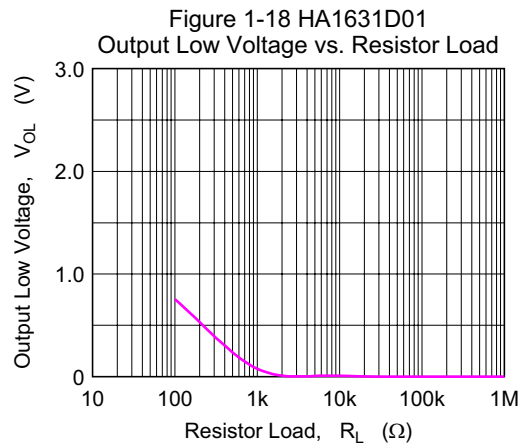
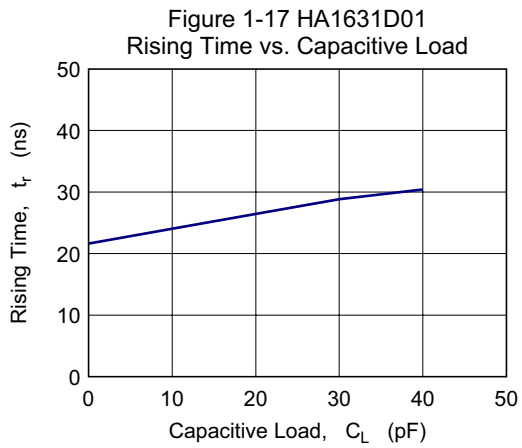
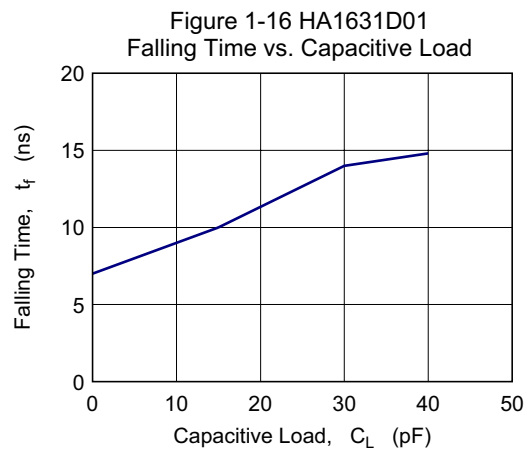
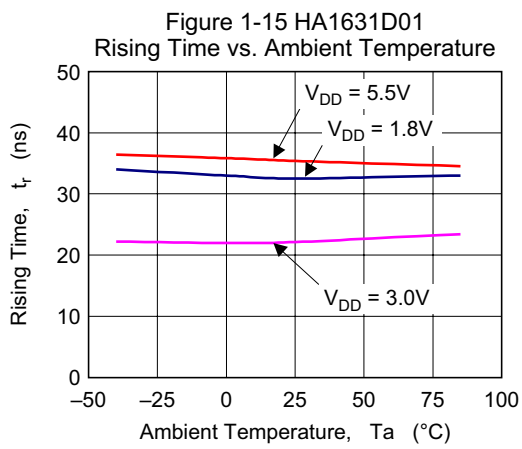
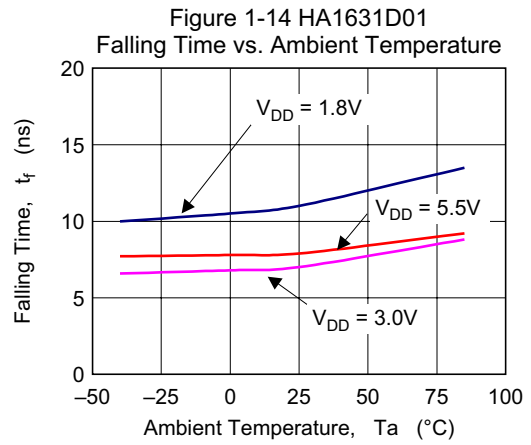
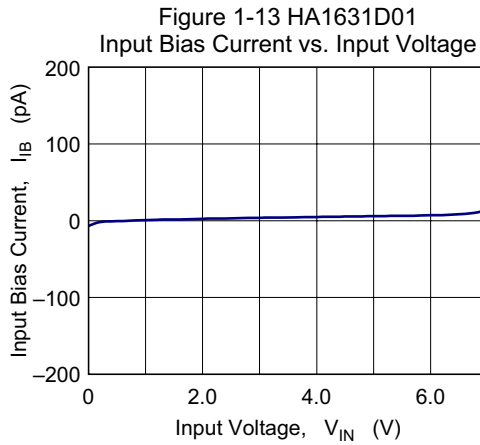

(unless otherwise noted, $V_{DD} = 3\text{ V}$, $V_{SS} = 0\text{ V}$, $T_a = 25^\circ\text{C}$)

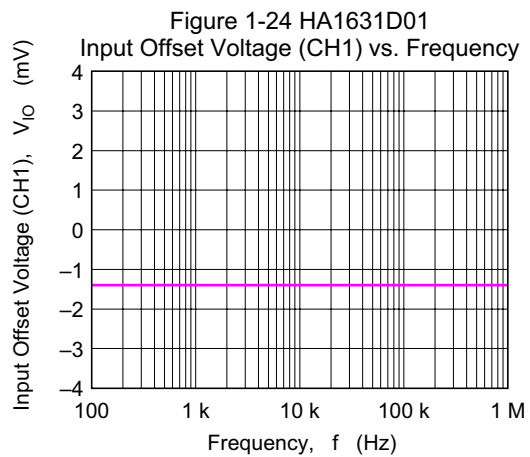
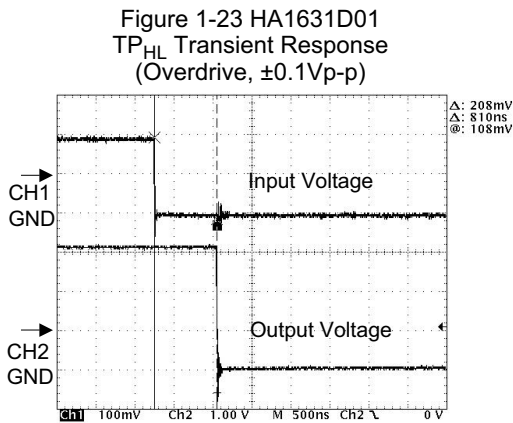
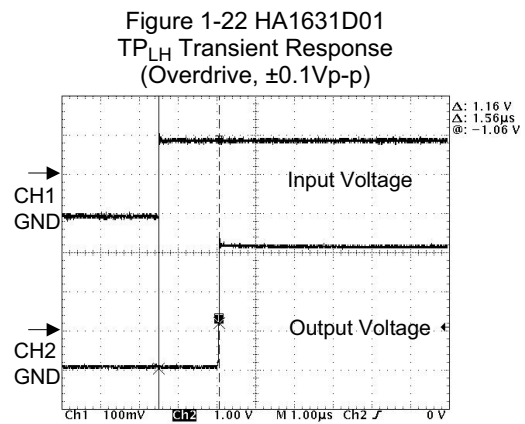
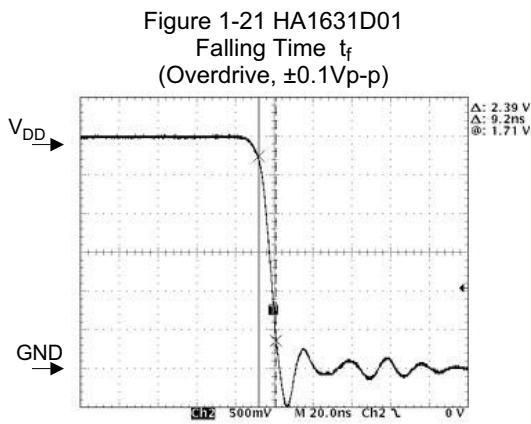
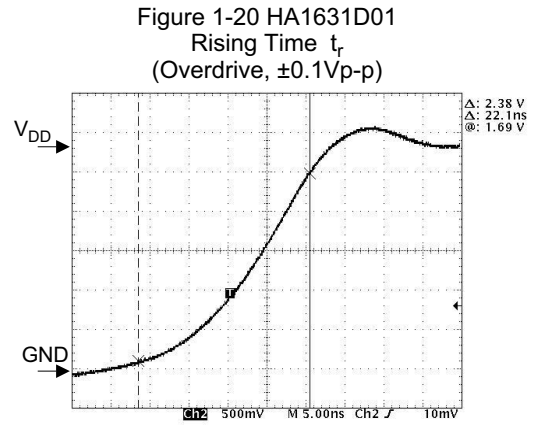
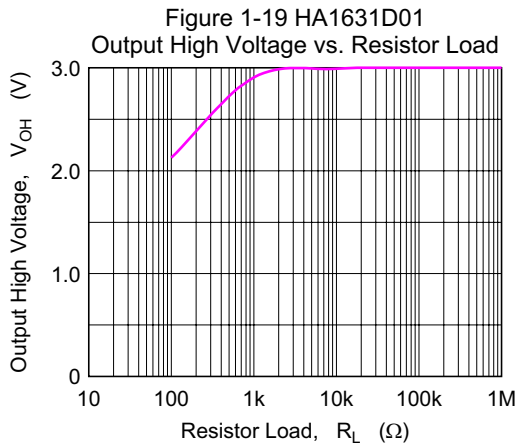

(unless otherwise noted, $V_{DD} = 3\text{ V}$, $V_{SS} = 0\text{ V}$, $T_a = 25^\circ\text{C}$)

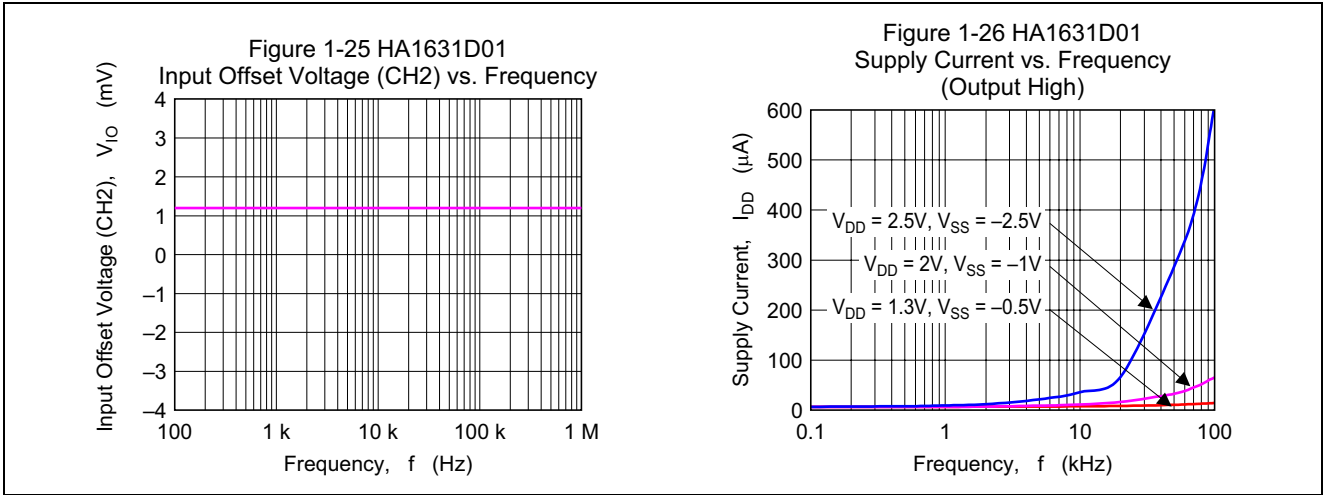

(unless otherwise noted, $V_{DD} = 3\text{ V}$, $V_{SS} = 0\text{ V}$, $T_a = 25^\circ\text{C}$)

Figure 2-1 HA1631D02
Supply Current vs. Supply Voltage
(Output High)

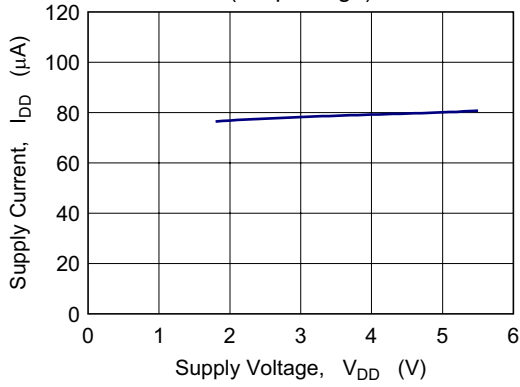

Figure 2-2 HA1631D02
Supply Current vs. Supply Voltage
(Output Low)

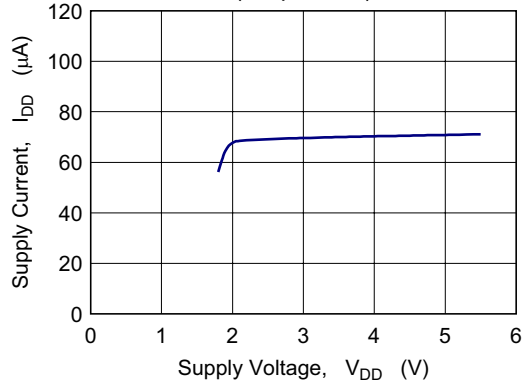

Figure 2-3 HA1631D02
Supply Current vs. Ambient Temperature

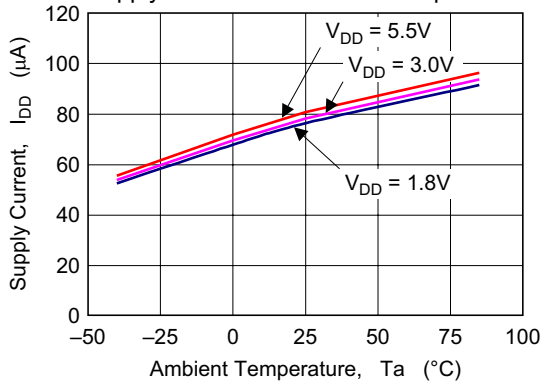

Figure 2-4 HA1631D02
Output High Voltage vs. Output Source Current

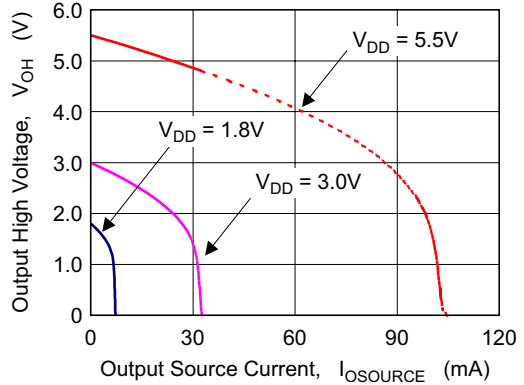

Figure 2-5 HA1631D02
Output Low Voltage vs. Output Sink Current

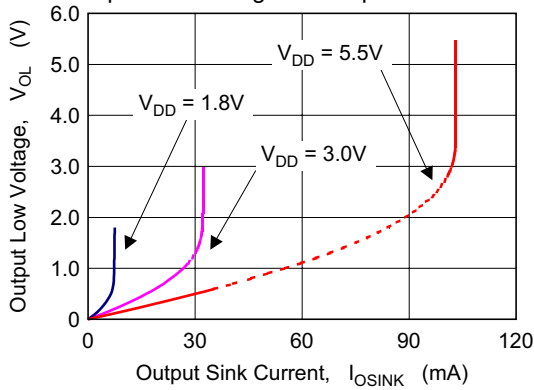
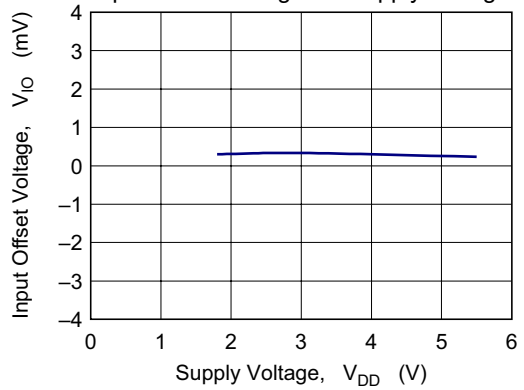
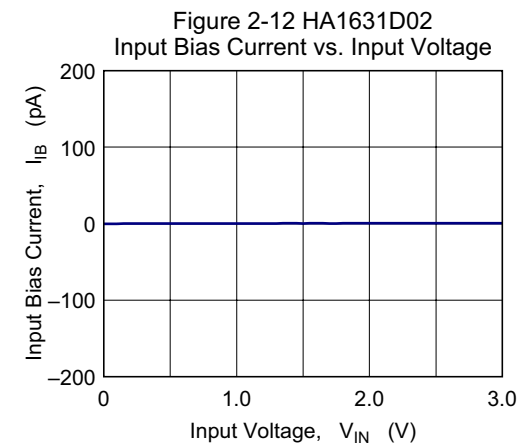
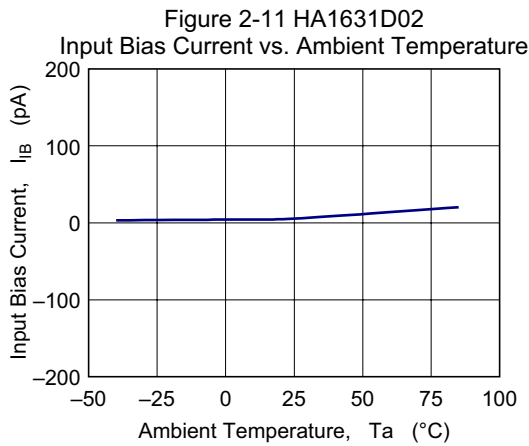
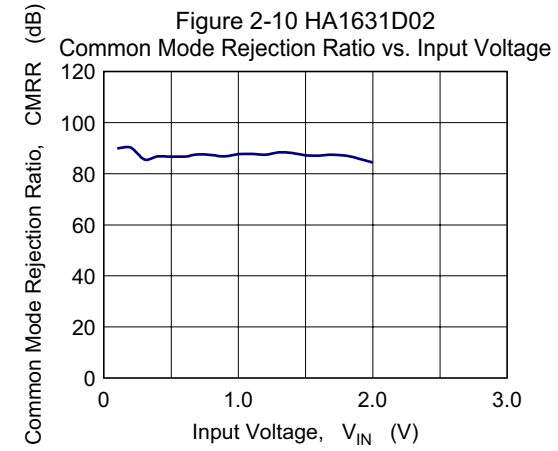
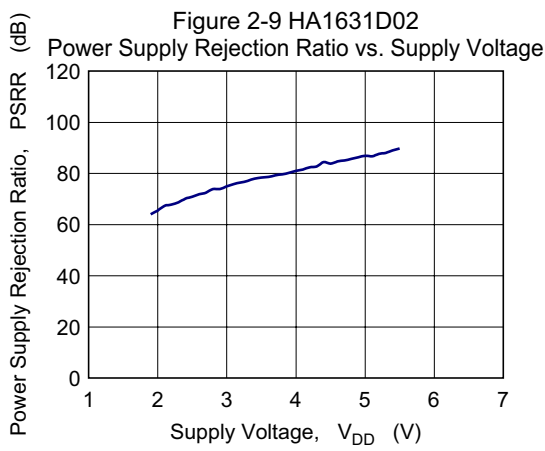
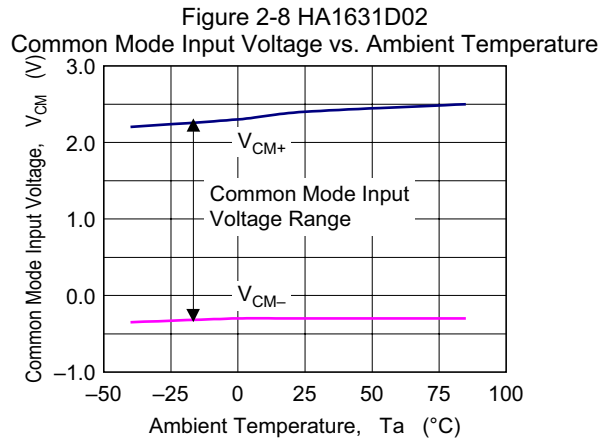
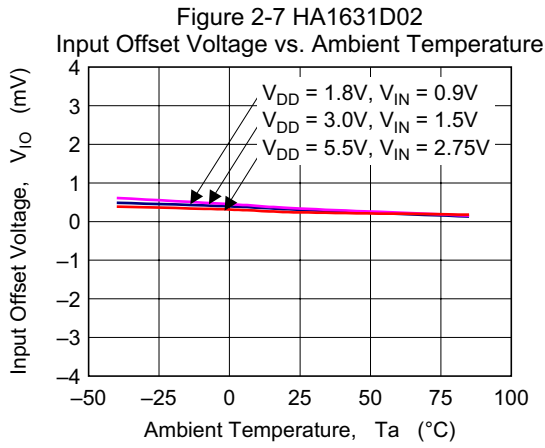

Figure 2-6 HA1631D02
Input Offset Voltage vs. Supply Voltage



(unless otherwise noted, $V_{DD} = 3\text{ V}$, $V_{SS} = 0\text{ V}$, $T_a = 25^\circ\text{C}$)



(unless otherwise noted, $V_{DD} = 3\text{ V}$, $V_{SS} = 0\text{ V}$, $T_a = 25^\circ\text{C}$)

Figure 2-13 HA1631D02
Input Bias Current vs. Input Voltage

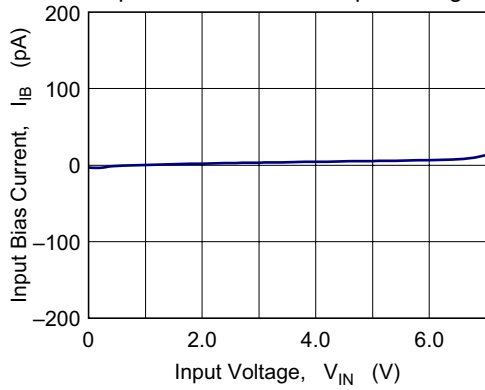

Figure 2-14 HA1631D02
Falling Time vs. Ambient Temperature

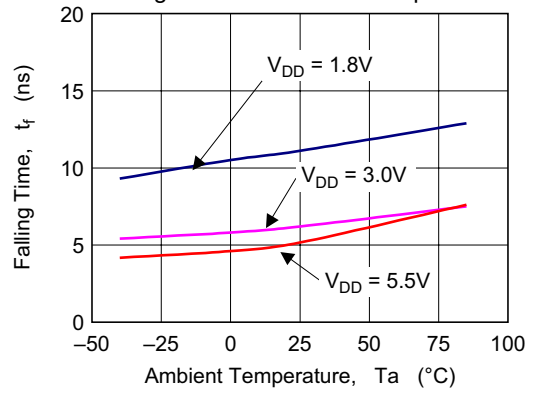

Figure 2-15 HA1631D02
Rising Time vs. Ambient Temperature

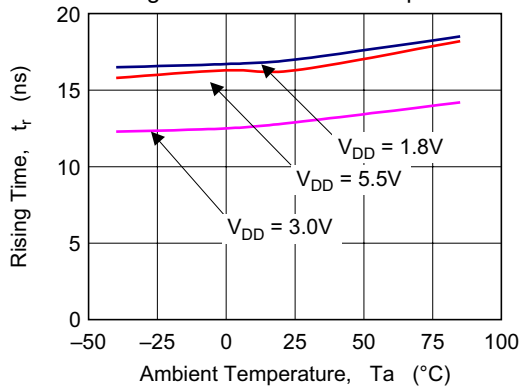

Figure 2-16 HA1631D02
Falling Time vs. Capacitive Load

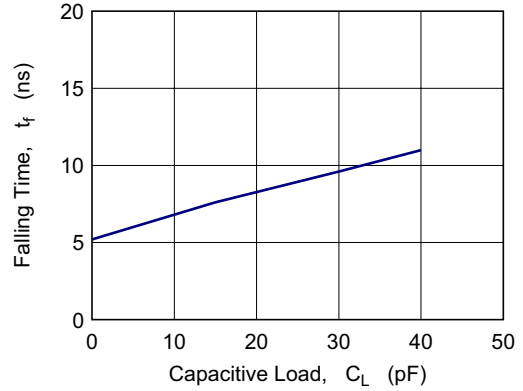

Figure 2-17 HA1631D02
Rising Time vs. Capacitive Load

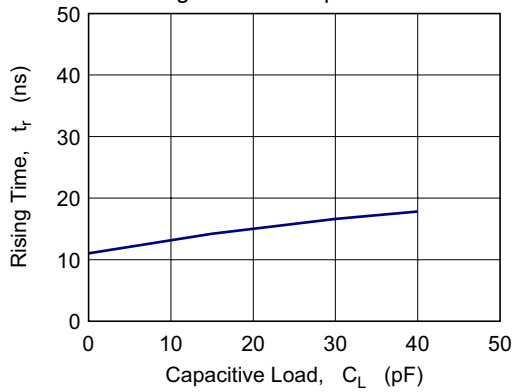
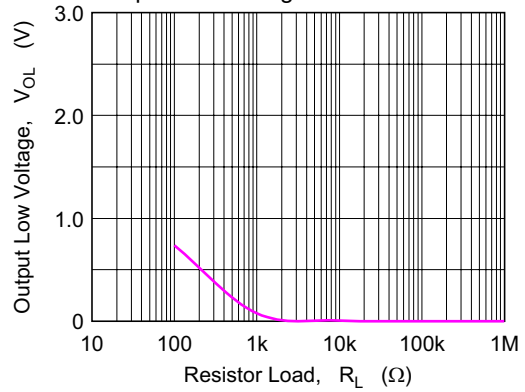
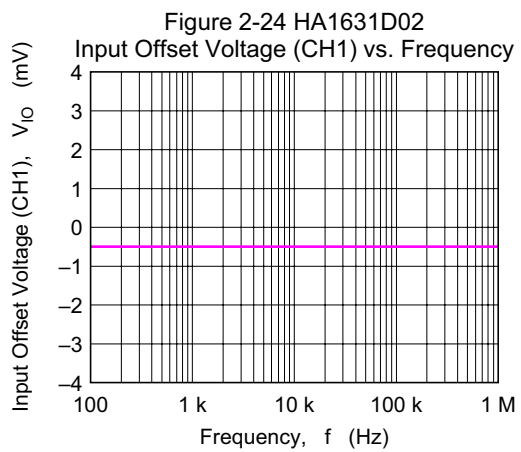
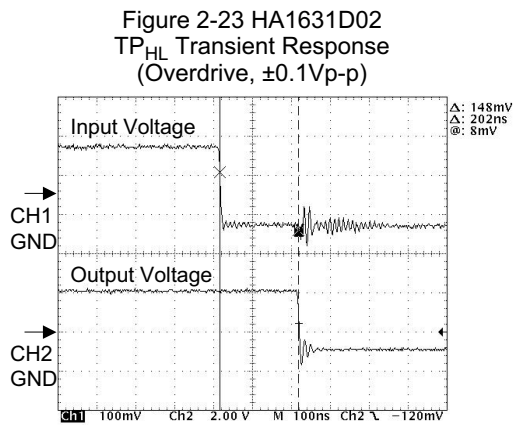
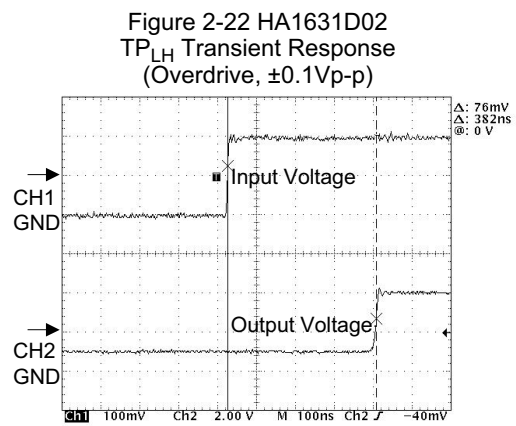
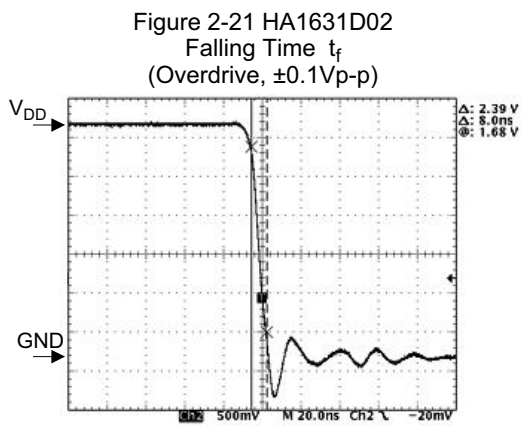
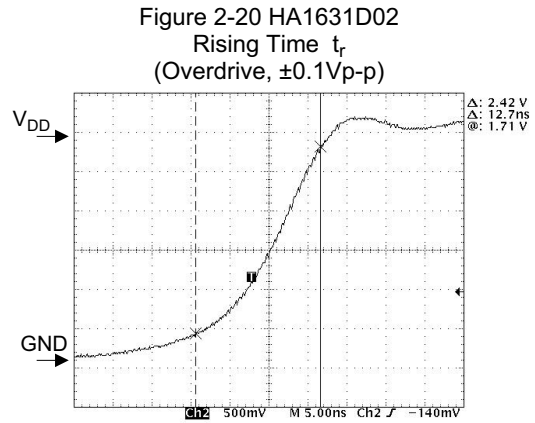
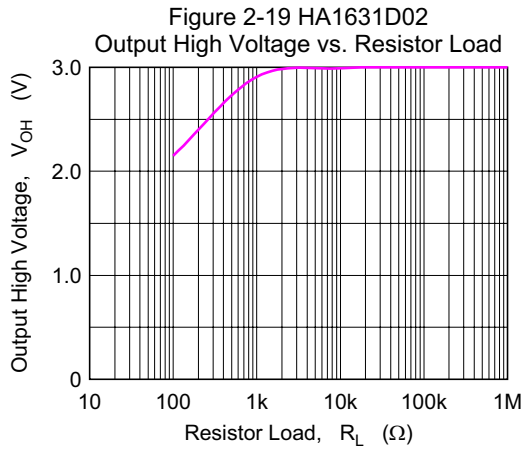

Figure 2-18 HA1631D02
Output Low Voltage vs. Resistor Load



(unless otherwise noted, $V_{DD} = 3\text{ V}$, $V_{SS} = 0\text{ V}$, $T_a = 25^\circ\text{C}$)



(unless otherwise noted, $V_{DD} = 3\text{ V}$, $V_{SS} = 0\text{ V}$, $T_a = 25^\circ\text{C}$)

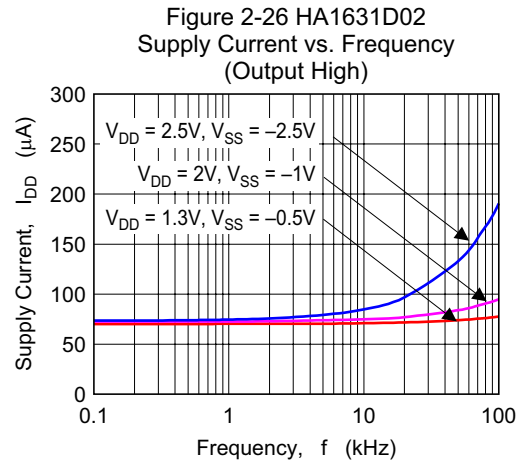
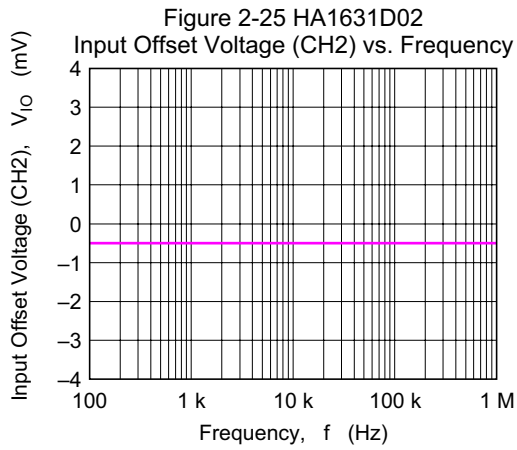

(unless otherwise noted, $V_{DD} = 3\text{ V}$, $V_{SS} = 0\text{ V}$, $T_a = 25^\circ\text{C}$)

Figure 3-1 HA1631D03
Supply Current vs. Supply Voltage
(Output High)

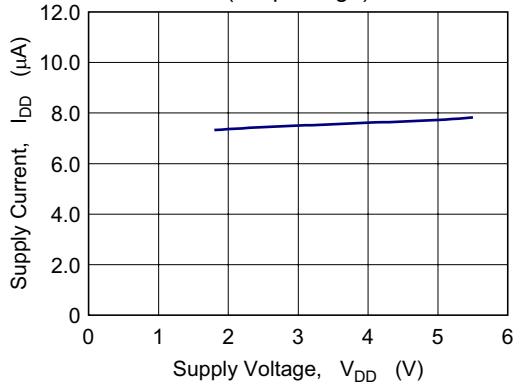

Figure 3-2 HA1631D03
Supply Current vs. Supply Voltage
(Output Low)

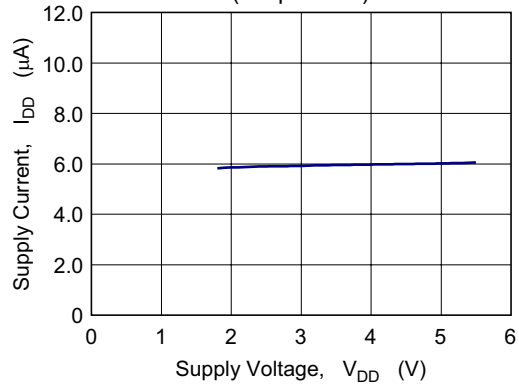

Figure 3-3 HA1631D03
Supply Current vs. Ambient Temperature

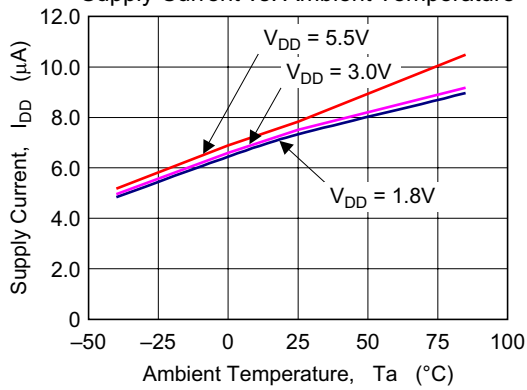

Figure 3-4 HA1631D03
Output Low Voltage vs. Output Sink Current

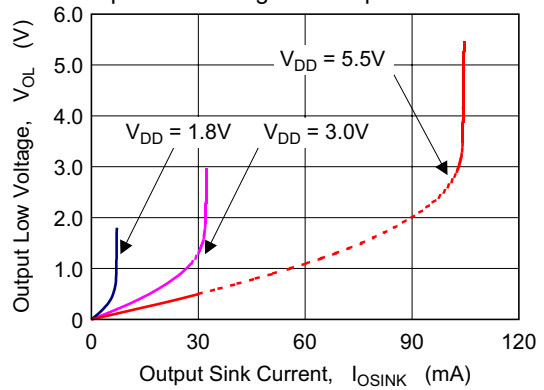

Figure 3-5 HA1631D03
Input Offset Voltage vs. Supply Voltage

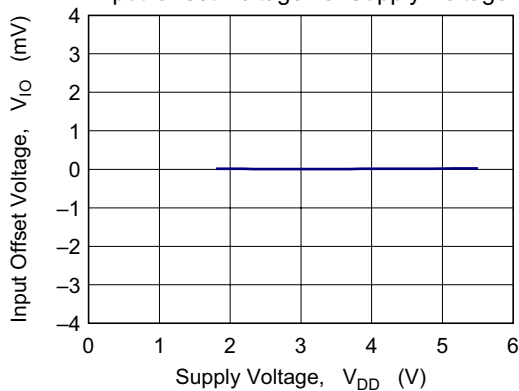
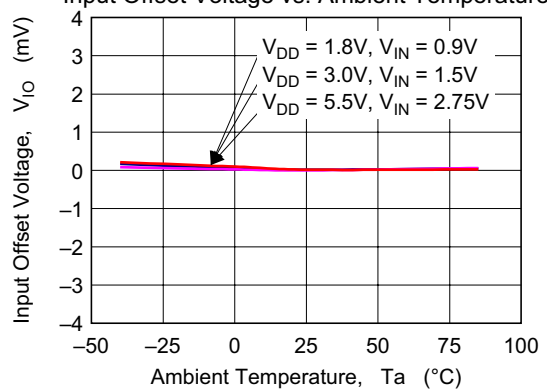

Figure 3-6 HA1631D03
Input Offset Voltage vs. Ambient Temperature



(unless otherwise noted, $V_{DD} = 3\text{ V}$, $V_{SS} = 0\text{ V}$, $T_a = 25^\circ\text{C}$)

Figure 3-7 HA1631D03
Common Mode Input Voltage vs. Ambient Temperature

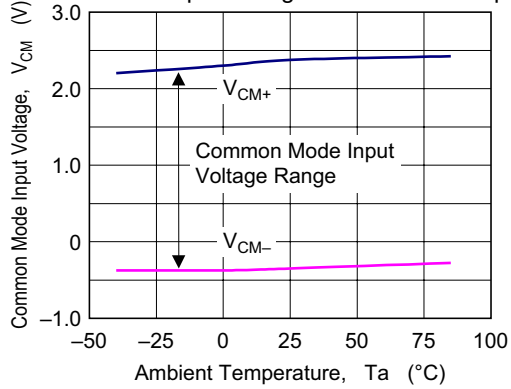

Figure 3-8 HA1631D03
Power Supply Rejection Ratio vs. Supply Voltage

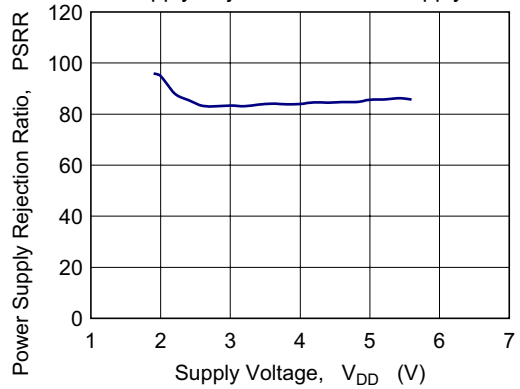

Figure 3-9 HA1631D03
Common Mode Rejection Ratio vs. Input Voltage

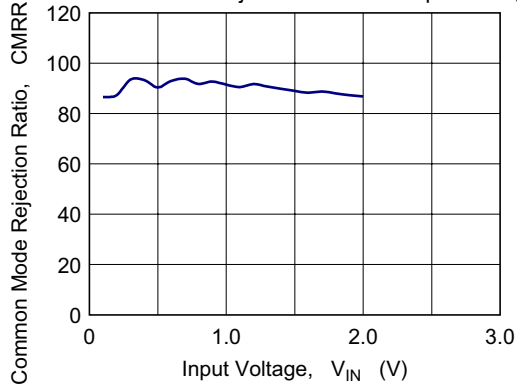

Figure 3-10 HA1631D03
Input Bias Current vs. Ambient Temperature

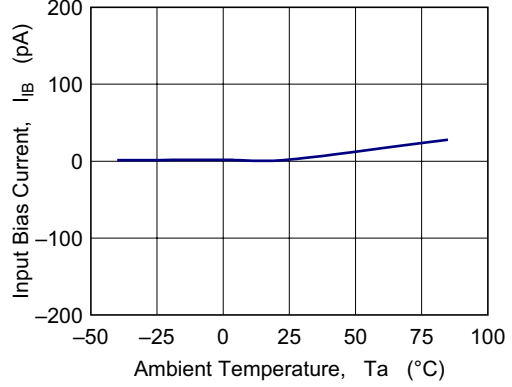

Figure 3-11 HA1631D03
Input Bias Current vs. Input Voltage

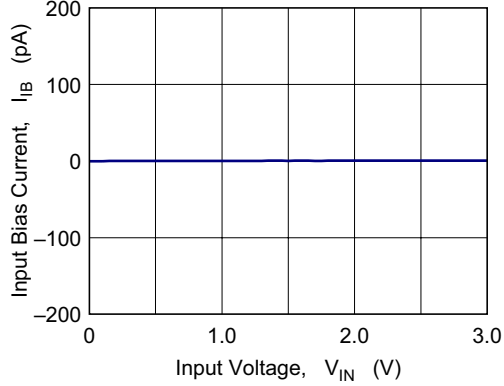
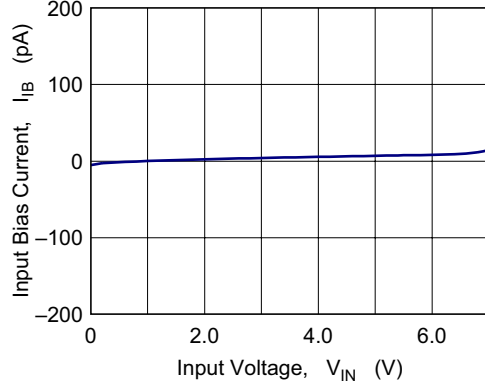
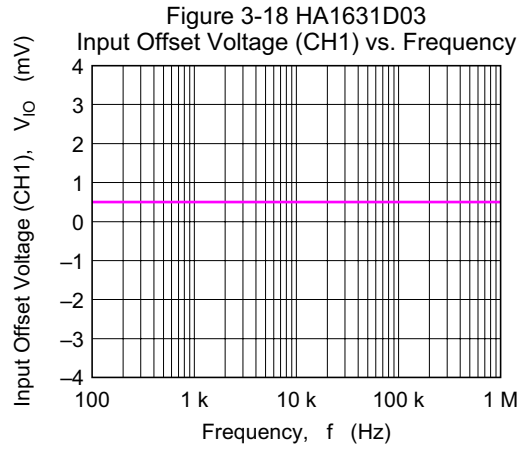
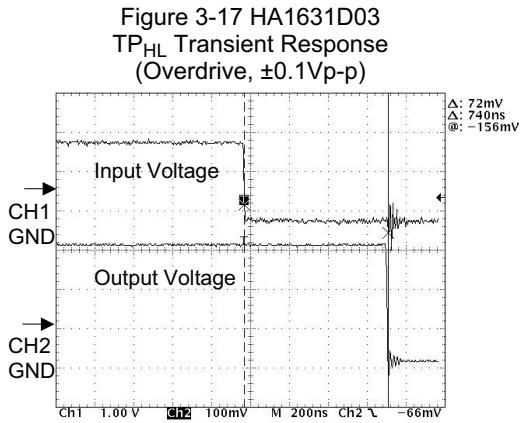
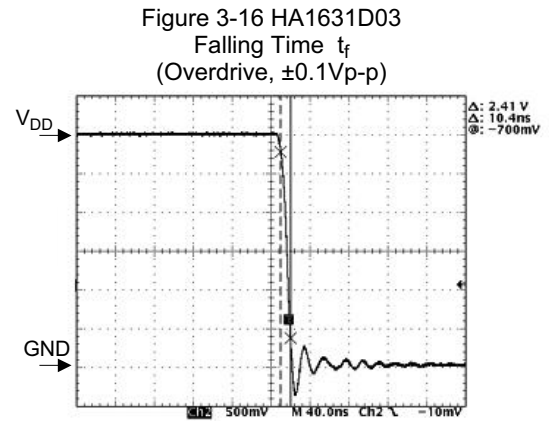
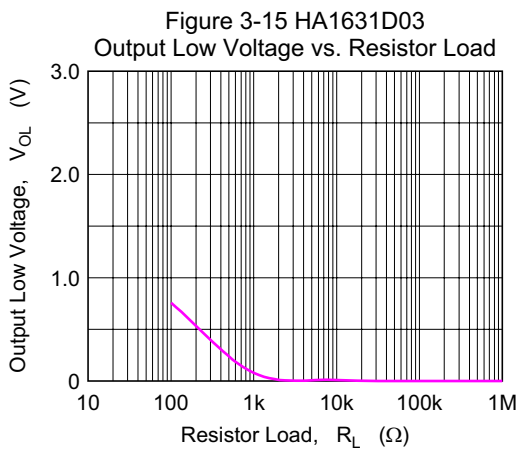
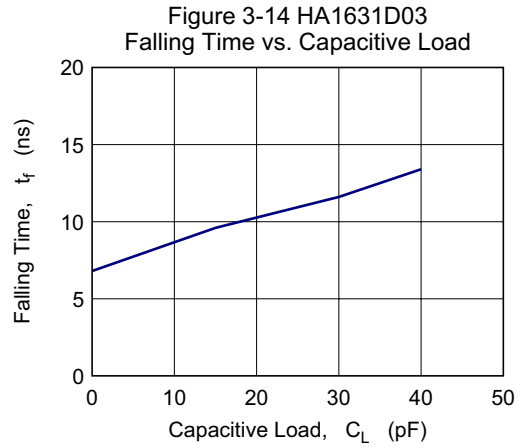
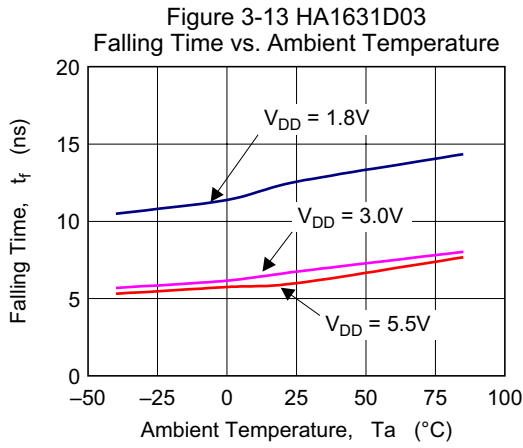

Figure 3-12 HA1631D03
Input Bias Current vs. Input Voltage



(unless otherwise noted, $V_{DD} = 3\text{ V}$, $V_{SS} = 0\text{ V}$, $T_a = 25^\circ\text{C}$)



(unless otherwise noted, $V_{DD} = 3\text{ V}$, $V_{SS} = 0\text{ V}$, $T_a = 25^\circ\text{C}$)

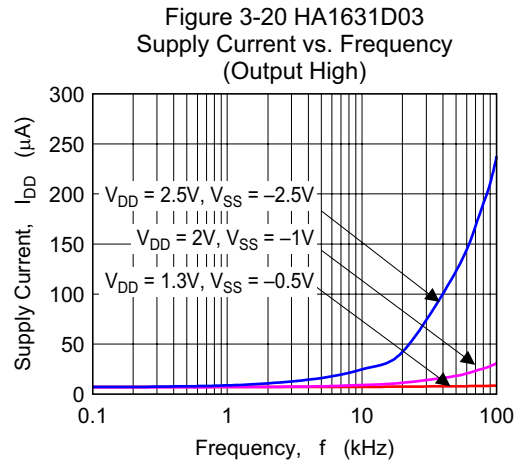
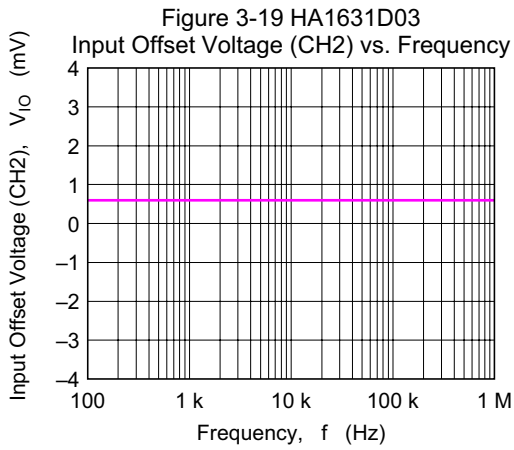

(unless otherwise noted, $V_{DD} = 3\text{ V}$, $V_{SS} = 0\text{ V}$, $T_a = 25^\circ\text{C}$)

Figure 4-1 HA1631D04
Supply Current vs. Supply Voltage
(Output High)

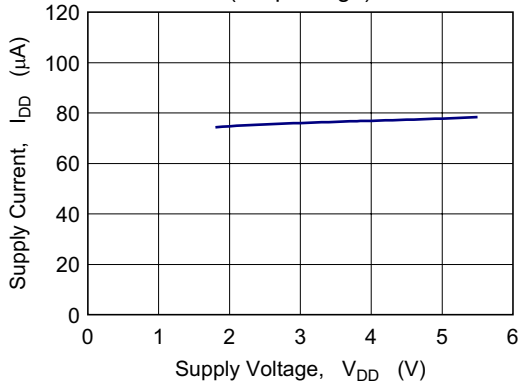

Figure 4-2 HA1631D04
Supply Current vs. Supply Voltage
(Output Low)

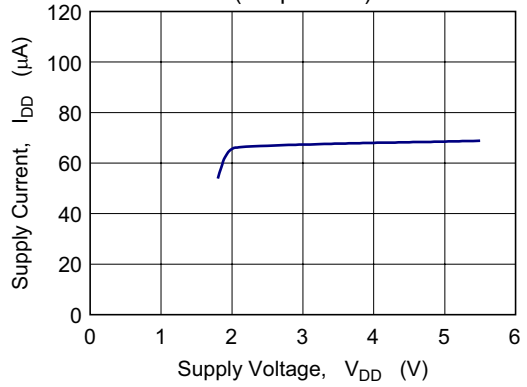

Figure 4-3 HA1631D04
Supply Current vs. Ambient Temperature

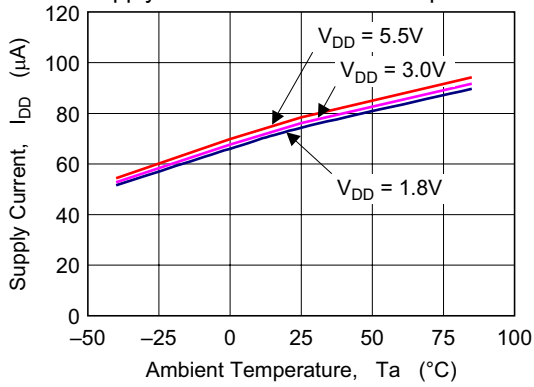

Figure 4-4 HA1631D04
Output Low Voltage vs. Output Sink Current

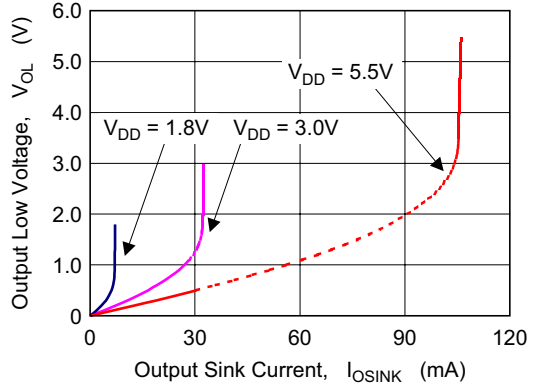

Figure 4-5 HA1631D04
Input Offset Voltage vs. Supply Voltage

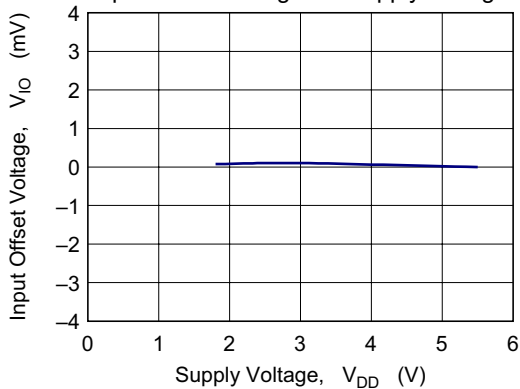
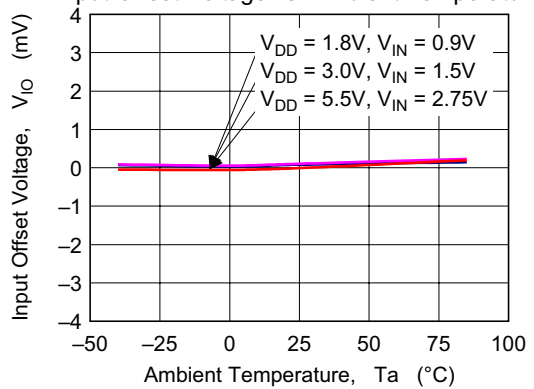
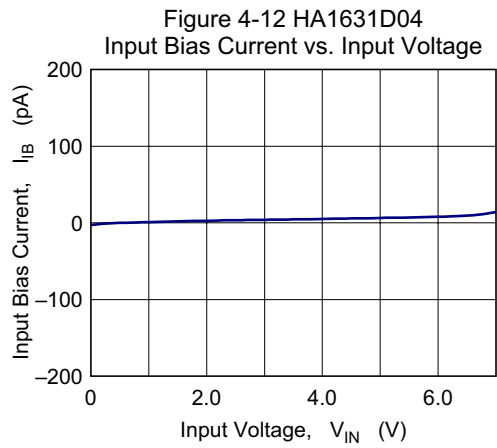
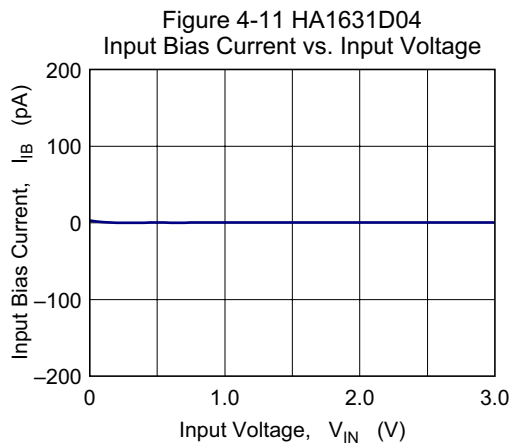
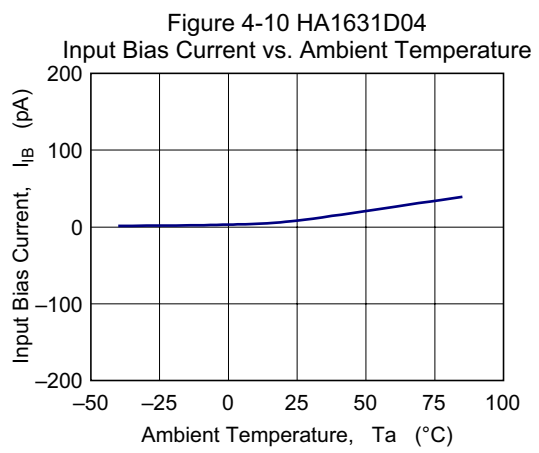
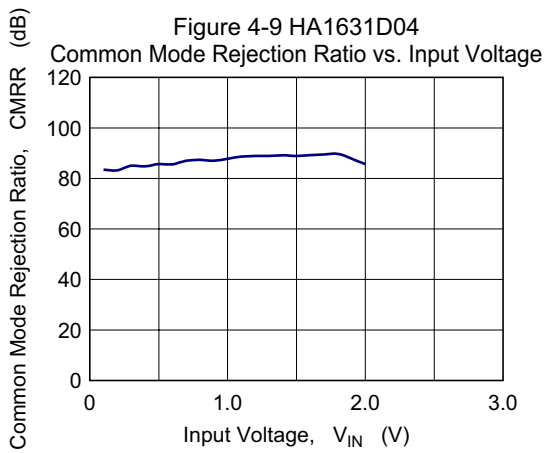
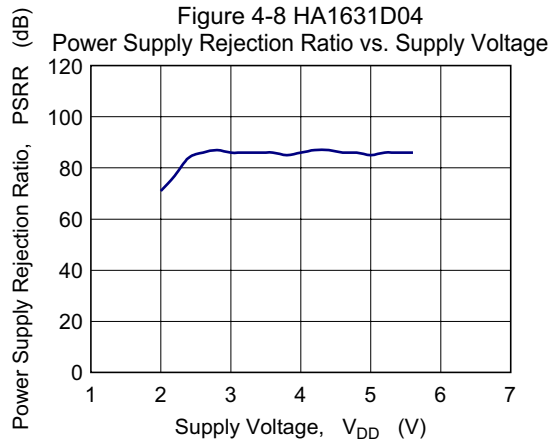
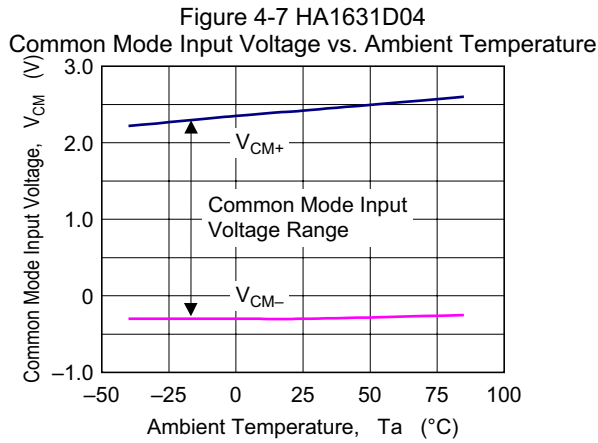

Figure 4-6 HA1631D04
Input Offset Voltage vs. Ambient Temperature



(unless otherwise noted, $V_{DD} = 3\text{ V}$, $V_{SS} = 0\text{ V}$, $T_a = 25^\circ\text{C}$)



(unless otherwise noted, $V_{DD} = 3\text{ V}$, $V_{SS} = 0\text{ V}$, $T_a = 25^\circ\text{C}$)

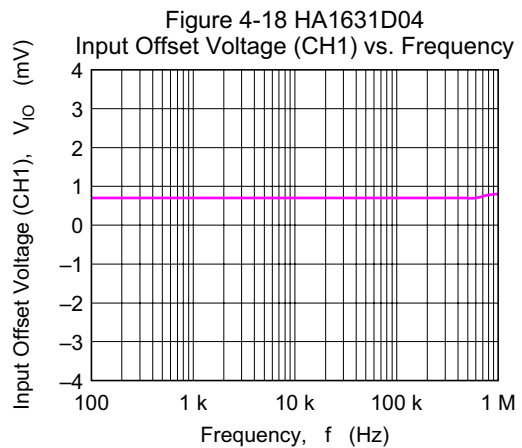
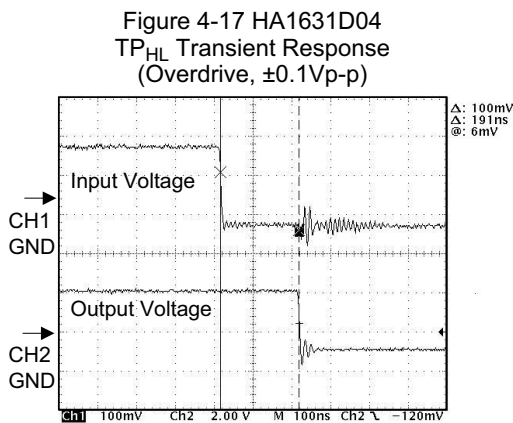
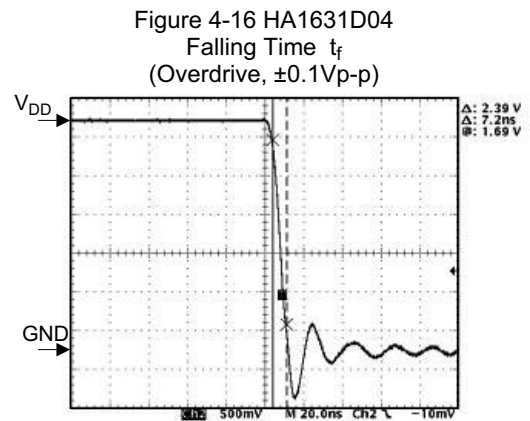
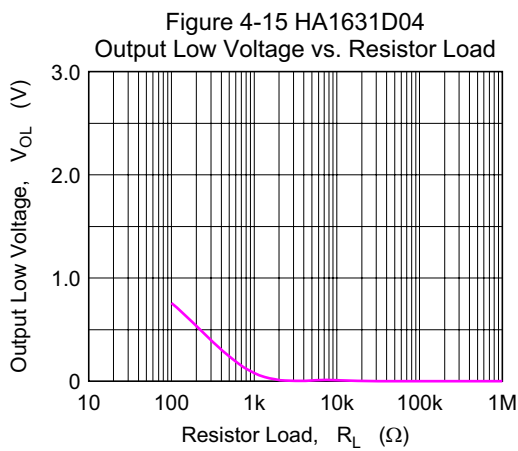
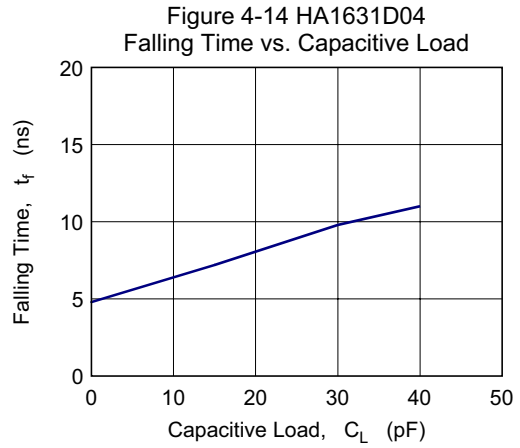
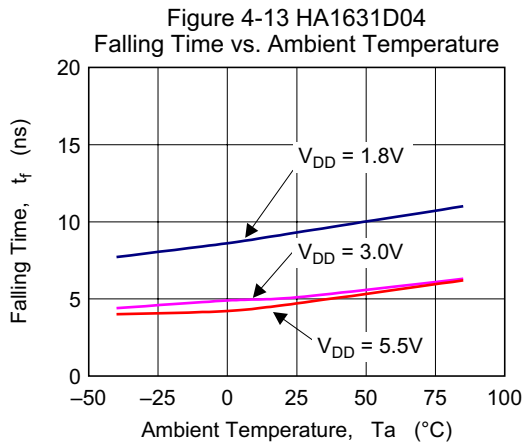

(unless otherwise noted, $V_{DD} = 3\text{ V}$, $V_{SS} = 0\text{ V}$, $T_a = 25^\circ\text{C}$)

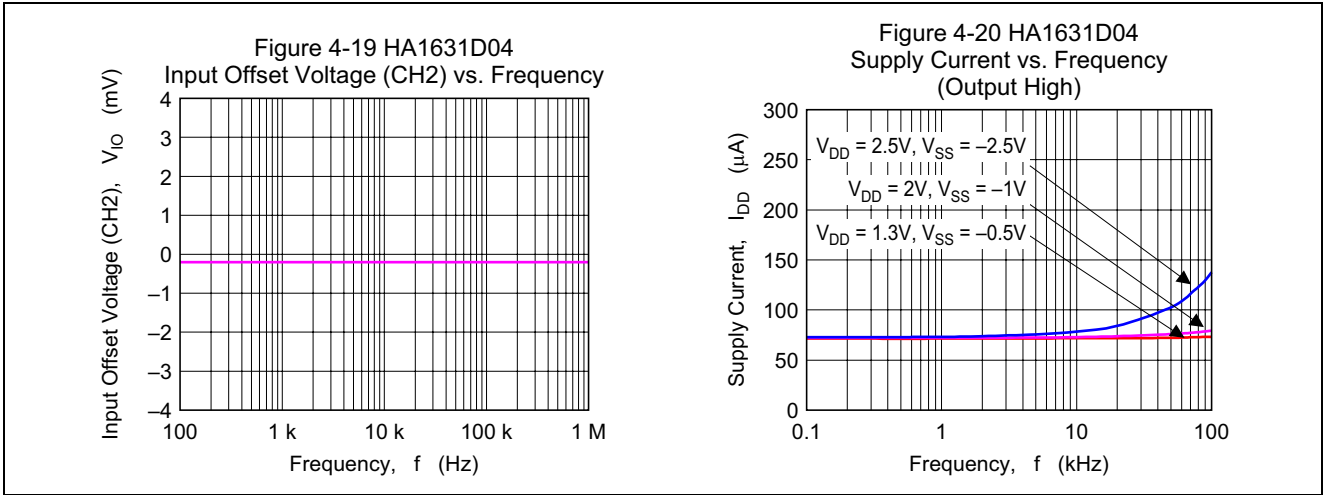

Test Circuits

(unless otherwise noted, $V_{DD} = 3\text{ V}$, $V_{SS} = 0\text{ V}$, $T_a = 25^\circ\text{C}$)

1. Supply Current, I_{DD} (Output High)

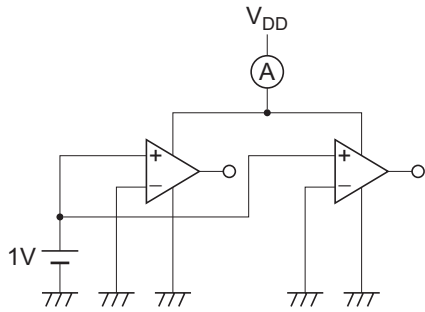

2. Supply Current, I_{DD} (Output Low)

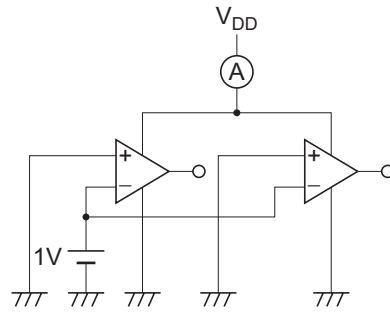

3. Output Source Current, $I_{OSOURCE}$

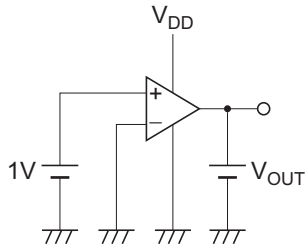

4. Output Voltage High, V_{OH}

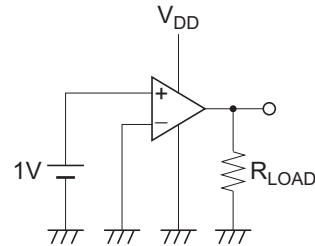

5. Output Sink Current, I_{OSINK}

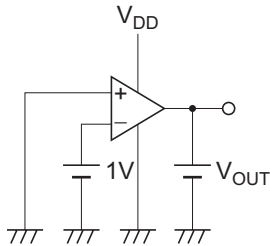

6. Output Voltage Low, V_{OL}

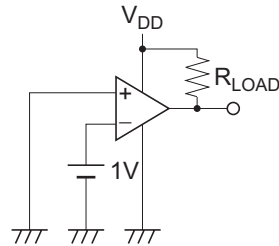

7. Input Offset Voltage, V_{IO}

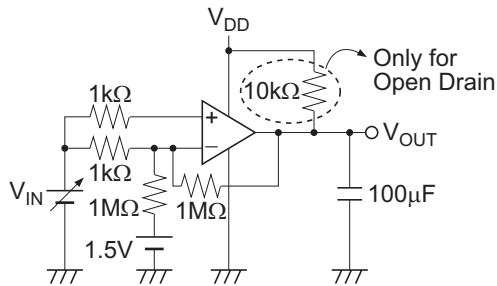

Note: $V_{IO} = V_{OUT} - 1.5\text{ V}$

8. Input Offset Voltage vs. Supply Voltage

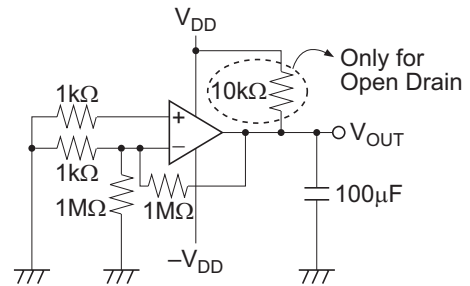

(unless otherwise noted, $V_{DD} = 3\text{ V}$, $V_{SS} = 0\text{ V}$, $T_a = 25^\circ\text{C}$)

9. Common Mode Input Voltage, V_{CM}

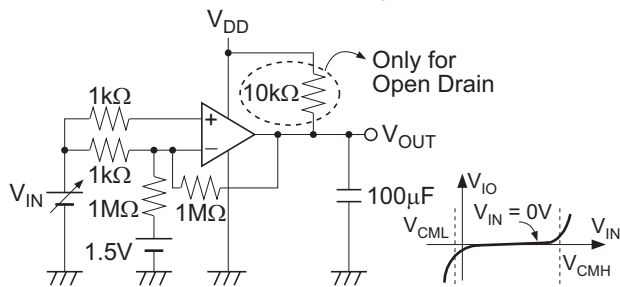

Note: V_{CML} and V_{CMH} are values of V_{IN} when V_{IO} changes more than 50dB taking $V_{IN} = 0\text{ V}$ as reference.

10. Input Bias Current, I_{IB}

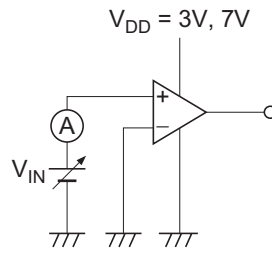

11. Power Supply Rejection Ratio, PSRR

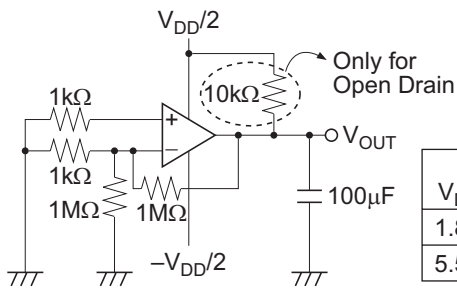

V_{DD}	Measure Point	Calculate V_{IO}	PSRR Calculation
1.8V	V_{OUT1}	$V_{IO1} = V_{OUT1}/1000$	$\text{PSRR} = \left 20 \log \frac{ (V_{IO2} - V_{IO1}) }{5.5\text{V} - 1.8\text{V}} \right $
5.5V	V_{OUT2}	$V_{IO2} = V_{OUT2}/1000$	

12. Common Mode Rejection Ratio, CMRR

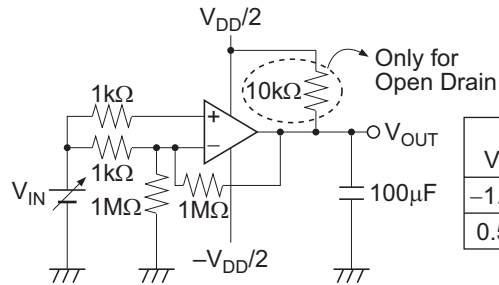

V_{IN}	Measure Point	Calculate V_{IO}	CMRR Calculation
-1.5V	V_{OUT1}	$V_{IO1} = V_{OUT1}/1000$	$\text{CMRR} = \left 20 \log \frac{ (V_{IO2} - V_{IO1}) }{0.5\text{V} - (-1.5\text{V})} \right $
0.5V	V_{OUT2}	$V_{IO2} = V_{OUT2}/1000$	

(unless otherwise noted, $V_{DD} = 3\text{ V}$, $V_{SS} = 0\text{ V}$, $T_a = 25^\circ\text{C}$)

13. Response Time t_r , t_f and Delay Time TP_{HL} , TP_{LH}

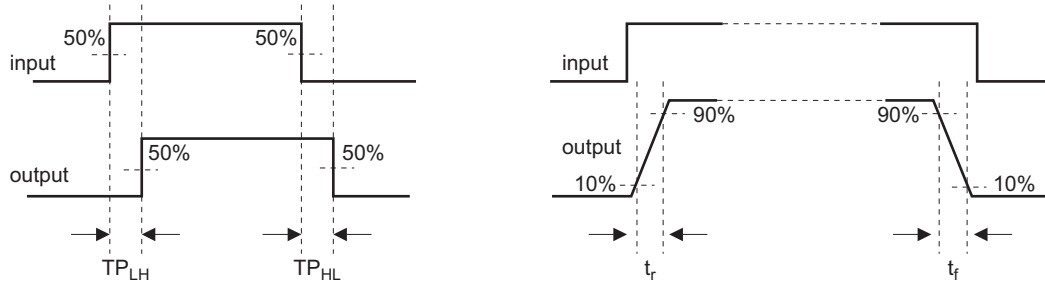
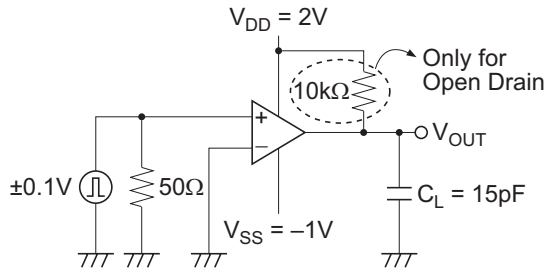

Only for Push Pull HA1631D01/02

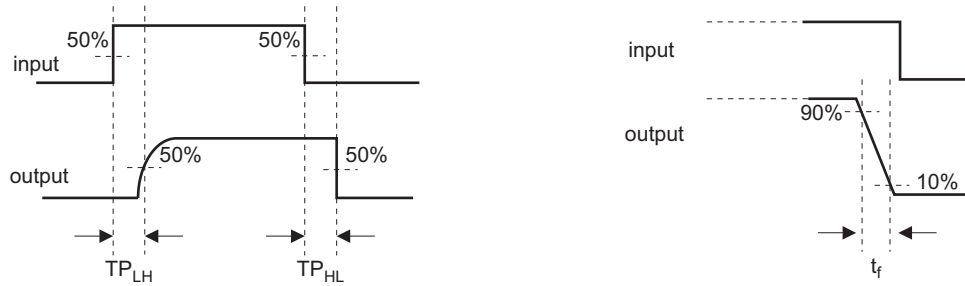

Only for Open Drain HA1631D03/04

14. Cross Talk

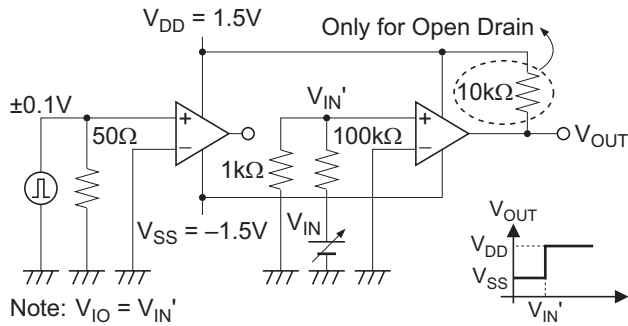

15. Supply Current, I_{DD} (Output High) vs. Frequency

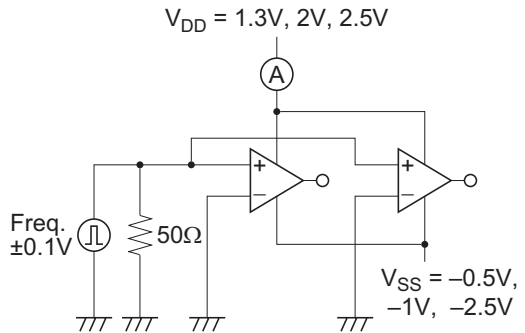

Package Dimensions

JEITA Package Code	RENESAS Code	Previous Code	MASS[Typ.]
P-TSSOP8-4.4x3-0.65	PTSP0008JC-B	TTP-8DAV	0.034g

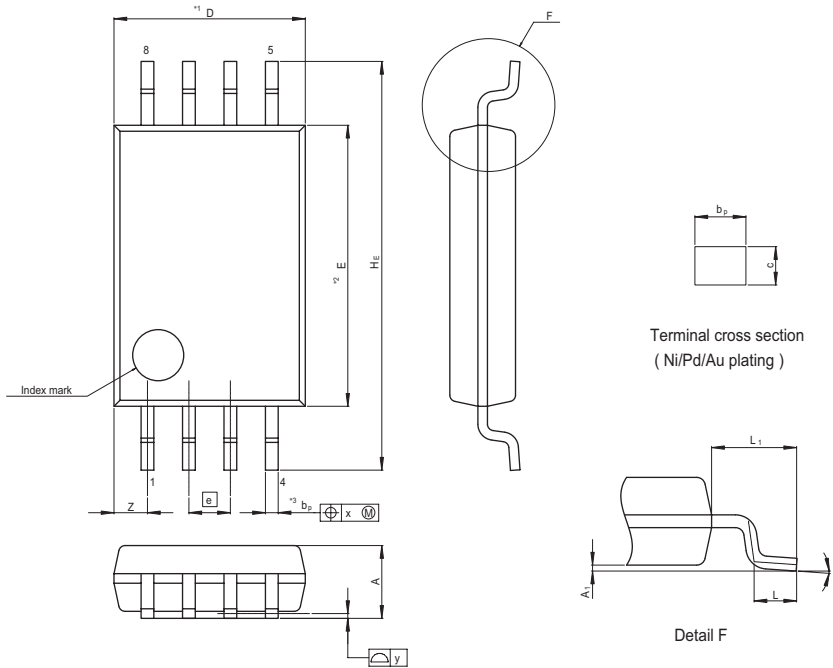

NOTE)
 1. DIMENSIONS**1 (Nom)*AND**2
 DO NOT INCLUDE MOLD FLASH.
 2. DIMENSION**3*DOES NOT
 INCLUDE TRIM OFFSET.

Reference Symbol	Dimension in Millimeters		
	Min	Nom	Max
D	—	3.00	3.30
E	—	4.40	—
A ₂	—	—	—
A ₁	0.03	0.07	0.10
A	—	—	1.10
b _p	0.15	0.20	0.25
b ₁	—	—	—
c	0.10	0.15	0.20
c ₁	—	—	—
θ	0°	—	8°
H _E	6.20	6.40	6.60
Ⓜ	—	0.65	—
x	—	—	0.13
y	—	—	0.10
Z	—	—	0.805
L	0.40	0.50	0.60
L ₁	—	1.00	—

Package Name	JEITA Package Code	RENESAS Code	Previous Code	MASS[Typ.]
MMPAK-8	P-LSOP8-2.8 x 2.95 - 0.65	PLSP0008JC-A	—	0.02 g

Unit: mm

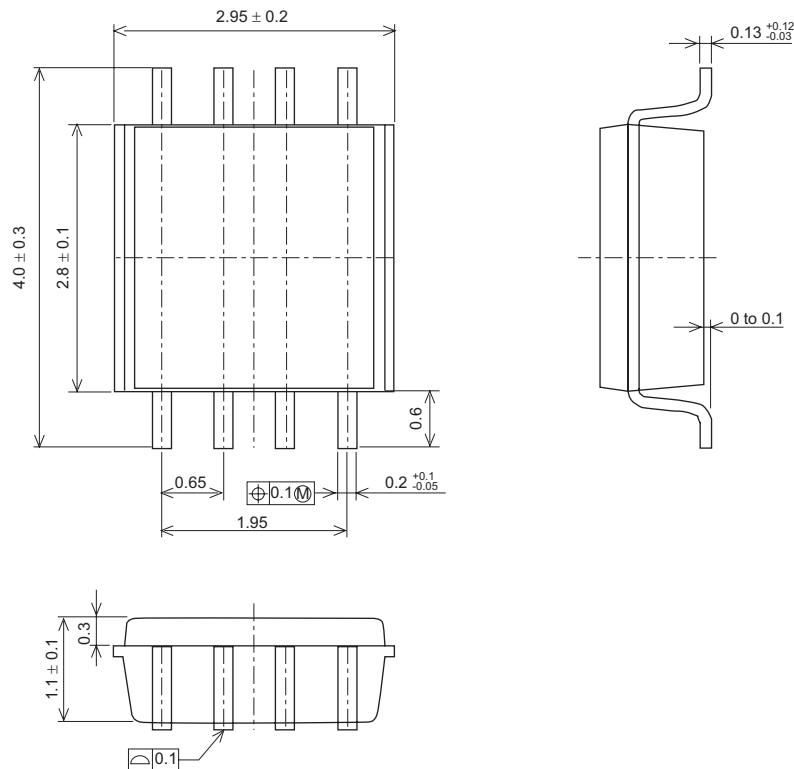

Notes:

1. This document is provided for reference purposes only so that Renesas customers may select the appropriate Renesas products for their use. Renesas neither makes warranties or representations with respect to the accuracy or completeness of the information contained in this document nor grants any license to any intellectual property rights or any other rights of Renesas or any third party with respect to the information in this document.
2. Renesas shall have no liability for damages or infringement of any intellectual property or other rights arising out of the use of any information in this document, including, but not limited to, product data, diagrams, charts, programs, algorithms, and application circuit examples.
3. You should not use the products or the technology described in this document for the purpose of military applications such as the development of weapons of mass destruction or for the purpose of any other military use. When exporting the products or technology described herein, you should follow the applicable export control laws and regulations, and procedures required by such laws and regulations.
4. All information included in this document such as product data, diagrams, charts, programs, algorithms, and application circuit examples, is current as of the date this document is issued. Such information, however, is subject to change without any prior notice. Before purchasing or using any Renesas products listed in this document, please confirm the latest product information with a Renesas sales office. Also, please pay regular and careful attention to additional and different information to be disclosed by Renesas such as that disclosed through our website. (<http://www.renesas.com>)
5. Renesas has used reasonable care in compiling the information included in this document, but Renesas assumes no liability whatsoever for any damages incurred as a result of errors or omissions in the information included in this document.
6. When using or otherwise relying on the information in this document, you should evaluate the information in light of the total system before deciding about the applicability of such information to the intended application. Renesas makes no representations, warranties or guaranties regarding the suitability of its products for any particular application and specifically disclaims any liability arising out of the application and use of the information in this document or Renesas products.
7. With the exception of products specified by Renesas as suitable for automobile applications, Renesas products are not designed, manufactured or tested for applications or otherwise in systems the failure or malfunction of which may cause a direct threat to human life or create a risk of human injury or which require especially high quality and reliability such as safety systems, or equipment or systems for transportation and traffic, healthcare, combustion control, aerospace and aeronautics, nuclear power, or undersea communication transmission. If you are considering the use of our products for such purposes, please contact a Renesas sales office beforehand. Renesas shall have no liability for damages arising out of the uses set forth above.
8. Notwithstanding the preceding paragraph, you should not use Renesas products for the purposes listed below:
 - (1) artificial life support devices or systems
 - (2) surgical implantations
 - (3) healthcare intervention (e.g., excision, administration of medication, etc.)
 - (4) any other purposes that pose a direct threat to human lifeRenesas shall have no liability for damages arising out of the uses set forth in the above and purchasers who elect to use Renesas products in any of the foregoing applications shall indemnify and hold harmless Renesas Technology Corp., its affiliated companies and their officers, directors, and employees against any and all damages arising out of such applications.
9. You should use the products described herein within the range specified by Renesas, especially with respect to the maximum rating, operating supply voltage range, movement power voltage range, heat radiation characteristics, installation and other product characteristics. Renesas shall have no liability for malfunctions or damages arising out of the use of Renesas products beyond such specified ranges.
10. Although Renesas endeavors to improve the quality and reliability of its products, IC products have specific characteristics such as the occurrence of failure at a certain rate and malfunctions under certain use conditions. Please be sure to implement safety measures to guard against the possibility of physical injury, and injury or damage caused by fire in the event of the failure of a Renesas product, such as safety design for hardware and software including but not limited to redundancy, fire control and malfunction prevention, appropriate treatment for aging degradation or any other applicable measures. Among others, since the evaluation of microcomputer software alone is very difficult, please evaluate the safety of the final products or system manufactured by you.
11. In case Renesas products listed in this document are detached from the products to which the Renesas products are attached or affixed, the risk of accident such as swallowing by infants and small children is very high. You should implement safety measures so that Renesas products may not be easily detached from your products. Renesas shall have no liability for damages arising out of such detachment.
12. This document may not be reproduced or duplicated, in any form, in whole or in part, without prior written approval from Renesas.
13. Please contact a Renesas sales office if you have any questions regarding the information contained in this document, Renesas semiconductor products, or if you have any other inquiries.



RENESAS SALES OFFICES

<http://www.renesas.com>

Refer to "<http://www.renesas.com/en/network>" for the latest and detailed information.

Renesas Technology America, Inc.

450 Holger Way, San Jose, CA 95134-1368, U.S.A
Tel: <1> (408) 382-7500, Fax: <1> (408) 382-7501

Renesas Technology Europe Limited

Dukes Meadow, Millboard Road, Bourne End, Buckinghamshire, SL8 5FH, U.K.
Tel: <44> (1628) 585-100, Fax: <44> (1628) 585-900

Renesas Technology (Shanghai) Co., Ltd.

Unit 204, 205, AZIACenter, No.1233 Lujiazui Ring Rd, Pudong District, Shanghai, China 200120
Tel: <86> (21) 5877-1818, Fax: <86> (21) 6887-7898

Renesas Technology Hong Kong Ltd.

7th Floor, North Tower, World Finance Centre, Harbour City, 1 Canton Road, Tsimshatsui, Kowloon, Hong Kong
Tel: <852> 2265-6688, Fax: <852> 2730-6071

Renesas Technology Taiwan Co., Ltd.

10th Floor, No.99, Fushing North Road, Taipei, Taiwan
Tel: <886> (2) 2715-2888, Fax: <886> (2) 2713-2999

Renesas Technology Singapore Pte. Ltd.

1 Harbour Front Avenue, #06-10, Keppel Bay Tower, Singapore 098632
Tel: <65> 6213-0200, Fax: <65> 6278-8001

Renesas Technology Korea Co., Ltd.

Kukje Center Bldg. 18th Fl., 191, 2-ka, Hangang-ro, Yongsan-ku, Seoul 140-702, Korea
Tel: <82> (2) 796-3115, Fax: <82> (2) 796-2145

Renesas Technology Malaysia Sdn. Bhd

Unit 906, Block B, Menara Amcorp, Amcorp Trade Centre, No.18, Jalan Persiaran Barat, 46050 Petaling Jaya, Selangor Darul Ehsan, Malaysia
Tel: <603> 7955-9390, Fax: <603> 7955-9510

To our customers,

Old Company Name in Catalogs and Other Documents

On April 1st, 2010, NEC Electronics Corporation merged with Renesas Technology Corporation, and Renesas Electronics Corporation took over all the business of both companies. Therefore, although the old company name remains in this document, it is a valid Renesas Electronics document. We appreciate your understanding.

Renesas Electronics website: <http://www.renesas.com>

April 1st, 2010
Renesas Electronics Corporation

Issued by: Renesas Electronics Corporation (<http://www.renesas.com>)

Send any inquiries to <http://www.renesas.com/inquiry>.

Notice

1. All information included in this document is current as of the date this document is issued. Such information, however, is subject to change without any prior notice. Before purchasing or using any Renesas Electronics products listed herein, please confirm the latest product information with a Renesas Electronics sales office. Also, please pay regular and careful attention to additional and different information to be disclosed by Renesas Electronics such as that disclosed through our website.
2. Renesas Electronics does not assume any liability for infringement of patents, copyrights, or other intellectual property rights of third parties by or arising from the use of Renesas Electronics products or technical information described in this document. No license, express, implied or otherwise, is granted hereby under any patents, copyrights or other intellectual property rights of Renesas Electronics or others.
3. You should not alter, modify, copy, or otherwise misappropriate any Renesas Electronics product, whether in whole or in part.
4. Descriptions of circuits, software and other related information in this document are provided only to illustrate the operation of semiconductor products and application examples. You are fully responsible for the incorporation of these circuits, software, and information in the design of your equipment. Renesas Electronics assumes no responsibility for any losses incurred by you or third parties arising from the use of these circuits, software, or information.
5. When exporting the products or technology described in this document, you should comply with the applicable export control laws and regulations and follow the procedures required by such laws and regulations. You should not use Renesas Electronics products or the technology described in this document for any purpose relating to military applications or use by the military, including but not limited to the development of weapons of mass destruction. Renesas Electronics products and technology may not be used for or incorporated into any products or systems whose manufacture, use, or sale is prohibited under any applicable domestic or foreign laws or regulations.
6. Renesas Electronics has used reasonable care in preparing the information included in this document, but Renesas Electronics does not warrant that such information is error free. Renesas Electronics assumes no liability whatsoever for any damages incurred by you resulting from errors in or omissions from the information included herein.
7. Renesas Electronics products are classified according to the following three quality grades: “Standard”, “High Quality”, and “Specific”. The recommended applications for each Renesas Electronics product depends on the product’s quality grade, as indicated below. You must check the quality grade of each Renesas Electronics product before using it in a particular application. You may not use any Renesas Electronics product for any application categorized as “Specific” without the prior written consent of Renesas Electronics. Further, you may not use any Renesas Electronics product for any application for which it is not intended without the prior written consent of Renesas Electronics. Renesas Electronics shall not be in any way liable for any damages or losses incurred by you or third parties arising from the use of any Renesas Electronics product for an application categorized as “Specific” or for which the product is not intended where you have failed to obtain the prior written consent of Renesas Electronics. The quality grade of each Renesas Electronics product is “Standard” unless otherwise expressly specified in a Renesas Electronics data sheets or data books, etc.
 - “Standard”: Computers; office equipment; communications equipment; test and measurement equipment; audio and visual equipment; home electronic appliances; machine tools; personal electronic equipment; and industrial robots.
 - “High Quality”: Transportation equipment (automobiles, trains, ships, etc.); traffic control systems; anti-disaster systems; anti-crime systems; safety equipment; and medical equipment not specifically designed for life support.
 - “Specific”: Aircraft; aerospace equipment; submersible repeaters; nuclear reactor control systems; medical equipment or systems for life support (e.g. artificial life support devices or systems), surgical implantations, or healthcare intervention (e.g. excision, etc.), and any other applications or purposes that pose a direct threat to human life.
8. You should use the Renesas Electronics products described in this document within the range specified by Renesas Electronics, especially with respect to the maximum rating, operating supply voltage range, movement power voltage range, heat radiation characteristics, installation and other product characteristics. Renesas Electronics shall have no liability for malfunctions or damages arising out of the use of Renesas Electronics products beyond such specified ranges.
9. Although Renesas Electronics endeavors to improve the quality and reliability of its products, semiconductor products have specific characteristics such as the occurrence of failure at a certain rate and malfunctions under certain use conditions. Further, Renesas Electronics products are not subject to radiation resistance design. Please be sure to implement safety measures to guard them against the possibility of physical injury, and injury or damage caused by fire in the event of the failure of a Renesas Electronics product, such as safety design for hardware and software including but not limited to redundancy, fire control and malfunction prevention, appropriate treatment for aging degradation or any other appropriate measures. Because the evaluation of microcomputer software alone is very difficult, please evaluate the safety of the final products or system manufactured by you.
10. Please contact a Renesas Electronics sales office for details as to environmental matters such as the environmental compatibility of each Renesas Electronics product. Please use Renesas Electronics products in compliance with all applicable laws and regulations that regulate the inclusion or use of controlled substances, including without limitation, the EU RoHS Directive. Renesas Electronics assumes no liability for damages or losses occurring as a result of your noncompliance with applicable laws and regulations.
11. This document may not be reproduced or duplicated, in any form, in whole or in part, without prior written consent of Renesas Electronics.
12. Please contact a Renesas Electronics sales office if you have any questions regarding the information contained in this document or Renesas Electronics products, or if you have any other inquiries.

(Note 1) “Renesas Electronics” as used in this document means Renesas Electronics Corporation and also includes its majority-owned subsidiaries.

(Note 2) “Renesas Electronics product(s)” means any product developed or manufactured by or for Renesas Electronics.

Mouser Electronics

Authorized Distributor

Click to View Pricing, Inventory, Delivery & Lifecycle Information:

Renesas Electronics:

[HA1631D03TEL-E](#) [HA1631D04TEL-E](#) [HA1631D02TEL-E](#) [HA1631D03MMEL-E](#) [HA1631D01MMEL-E](#)
[HA1631D01TEL-E](#) [HA1631D02MMEL-E](#) [HA1631D04MMEL-E](#)

Компания «Life Electronics» занимается поставками электронных компонентов импортного и отечественного производства от производителей и со складов крупных дистрибьюторов Европы, Америки и Азии.

С конца 2013 года компания активно расширяет линейку поставок компонентов по направлению коаксиальный кабель, кварцевые генераторы и конденсаторы (керамические, пленочные, электролитические), за счёт заключения дистрибьюторских договоров

Мы предлагаем:

- Конкуренспособные цены и скидки постоянным клиентам.
- Специальные условия для постоянных клиентов.
- Подбор аналогов.
- Поставку компонентов в любых объемах, удовлетворяющих вашим потребностям.
- Приемлемые сроки поставки, возможна ускоренная поставка.
- Доставку товара в любую точку России и стран СНГ.
- Комплексную поставку.
- Работу по проектам и поставку образцов.
- Формирование склада под заказчика.
- Сертификаты соответствия на поставляемую продукцию (по желанию клиента).
- Тестирование поставляемой продукции.
- Поставку компонентов, требующих военную и космическую приемку.
- Входной контроль качества.
- Наличие сертификата ISO.

В составе нашей компании организован Конструкторский отдел, призванный помогать разработчикам, и инженерам.

Конструкторский отдел помогает осуществить:

- Регистрацию проекта у производителя компонентов.
- Техническую поддержку проекта.
- Защиту от снятия компонента с производства.
- Оценку стоимости проекта по компонентам.
- Изготовление тестовой платы монтаж и пусконаладочные работы.



Тел: +7 (812) 336 43 04 (многоканальный)

Email: org@lifeelectronics.ru