

UMC2NT1G, NSVUMC2NT1G, UMC3NT1G, NSVUMC3NT1G, UMC5NT1G, NSVUMC5NT2G

Dual Common Base-Collector Bias Resistor Transistors

NPN and PNP Silicon Surface Mount Transistors with Monolithic Bias Resistor Network

The Bias Resistor Transistor (BRT) contains a single transistor with a monolithic bias network consisting of two resistors; a series base resistor and a base-emitter resistor. These digital transistors are designed to replace a single device and its external resistor bias network. The BRT eliminates these individual components by integrating them into a single device. In the UMC2NT1G series, two complementary BRT devices are housed in the SOT-353 package which is ideal for low power surface mount applications where board space is at a premium.

Features

- Simplifies Circuit Design
- Reduces Board Space
- Reduces Component Count
- Available in 8 mm, 7 inch/3000 Unit Tape and Reel
- AEC-Q101 Qualified and PPAP Capable
- NSV Prefix for Automotive and Other Applications Requiring Unique Site and Control Change Requirements
- These Devices are Pb-Free, Halogen Free/BFR Free and are RoHS Compliant*

MAXIMUM RATINGS ($T_A = 25^\circ\text{C}$ unless otherwise noted, common for Q_1 and Q_2 , - minus sign for Q_1 (PNP) omitted)

Rating	Symbol	Value	Unit
Collector-Base Voltage	V_{CBO}	50	Vdc
Collector-Emitter Voltage	V_{CEO}	50	Vdc
Collector Current	I_C	100	mAdc

Stresses exceeding Maximum Ratings may damage the device. Maximum Ratings are stress ratings only. Functional operation above the Recommended Operating Conditions is not implied. Extended exposure to stresses above the Recommended Operating Conditions may affect device reliability.

*For additional information on our Pb-Free strategy and soldering details, please download the ON Semiconductor Soldering and Mounting Techniques Reference Manual, SOLDERRM/D.



ON Semiconductor®

<http://onsemi.com>

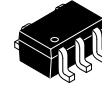

SC-88A/SOT-353
CASE 419A
STYLE 6

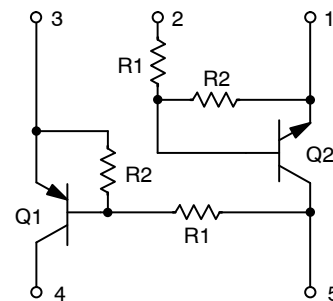

MARKING DIAGRAM



Ux = Device Marking
x = 2, 3 or 5
M = Date Code
▪ = Pb-Free Package

(Note: Microdot may be in either location)

ORDERING INFORMATION

See detailed ordering and shipping information in the package dimensions section on page 4 of this data sheet.

UMC2NT1G, NSVUMC2NT1G, UMC3NT1G, NSVUMC3NT1G, UMC5NT1G, NSVUMC5NT2G

MAXIMUM RATINGS ($T_A = 25^\circ\text{C}$ unless otherwise noted, common for Q_1 and Q_2 , – minus sign for Q_1 (PNP) omitted)

Rating	Symbol	Value	Unit
THERMAL CHARACTERISTICS			
Thermal Resistance – Junction-to-Ambient (surface mounted)	$R_{\theta JA}$	833	$^\circ\text{C}/\text{W}$
Operating and Storage Temperature Range	T_J, T_{stg}	-65 to +150	$^\circ\text{C}$
Total Package Dissipation @ $T_A = 25^\circ\text{C}$ (Note 1)	P_D	150	mW

1. Device mounted on a FR-4 glass epoxy printed circuit board using the minimum recommended footprint.

ELECTRICAL CHARACTERISTICS ($T_A = 25^\circ\text{C}$ unless otherwise noted)

Characteristic	Symbol	Min	Typ	Max	Unit
----------------	--------	-----	-----	-----	------

Q1 TRANSISTOR: PNP

OFF CHARACTERISTICS

Collector-Base Cutoff Current ($V_{CB} = 50\text{ V}, I_E = 0$)	I_{CBO}	-	-	100	nAdc
Collector-Emitter Cutoff Current ($V_{CE} = 50\text{ V}, I_B = 0$)	I_{CEO}	-	-	500	nAdc
Emitter-Base Cutoff Current ($V_{EB} = 6.0, I_C = 0\text{ mA}$) UMC2NT1G, NSVUMC2NT1G UMC3NT1G, NSVUMC3NT1G UMC5NT1G/T2G, NSVUMC5NT2G	I_{EBO}	-	-	0.2 0.5 1.0	mAdc

ON CHARACTERISTICS

Collector-Base Breakdown Voltage ($I_C = 10\ \mu\text{A}, I_E = 0$)	$V_{(BR)CBO}$	50	-	-	Vdc
Collector-Emitter Breakdown Voltage ($I_C = 2.0\text{ mA}, I_B = 0$)	$V_{(BR)CEO}$	50	-	-	Vdc
DC Current Gain ($V_{CE} = 10\text{ V}, I_C = 5.0\text{ mA}$) UMC2NT1G, NSVUMC2NT1G UMC3NT1G, NSVUMC3NT1G UMC5NT1G/T2G, NSVUMC5NT2G	h_{FE}	60 35 20	100 60 35	- - -	
Collector-Emitter Saturation Voltage ($I_C = 10\text{ mA}, I_B = 0.3\text{ mA}$)	$V_{CE(SAT)}$	-	-	0.25	Vdc
Output Voltage (on) ($V_{CC} = 5.0\text{ V}, V_B = 2.5\text{ V}, R_L = 1.0\text{ k}\Omega$)	V_{OL}	-	-	0.2	Vdc
Output Voltage (off) ($V_{CC} = 5.0\text{ V}, V_B = 0.5\text{ V}, R_L = 1.0\text{ k}\Omega$)	V_{OH}	4.9	-	-	Vdc
Input Resistor UMC2NT1G UMC3NT1G UMC5NT1G/T2G	R1	15.4 7.0 3.3	22 10 4.7	28.6 13 6.1	$\text{k}\Omega$
Resistor Ratio UMC2NT1G UMC3NT1G UMC5NT1G/T2G	R1/R2	0.8 0.8 0.38	1.0 1.0 0.47	1.2 1.2 0.56	

**UMC2NT1G, NSVUMC2NT1G, UMC3NT1G, NSVUMC3NT1G, UMC5NT1G,
NSVUMC5NT2G**

ELECTRICAL CHARACTERISTICS ($T_A = 25^\circ\text{C}$ unless otherwise noted)

Characteristic	Symbol	Min	Typ	Max	Unit
----------------	--------	-----	-----	-----	------

**Q2 TRANSISTOR: NPN
OFF CHARACTERISTICS**

Collector-Base Cutoff Current ($V_{CB} = 50\text{ V}$, $I_E = 0$)	I_{CBO}	-	-	100	nAdc
Collector-Emitter Cutoff Current ($V_{CE} = 50\text{ V}$, $I_B = 0$)	I_{CEO}	-	-	500	nAdc
Emitter-Base Cutoff Current ($V_{EB} = 6.0$, $I_C = 0\text{ mA}$)	I_{EBO}				mAdc
UMC2NT1G		-	-	0.2	
UMC3NT1G		-	-	0.5	
UMC5NT1G/T2G		-	-	0.1	

ON CHARACTERISTICS

Collector-Base Breakdown Voltage ($I_C = 10\ \mu\text{A}$, $I_E = 0$)	$V_{(BR)CBO}$	50	-	-	Vdc
Collector-Emitter Breakdown Voltage ($I_C = 2.0\text{ mA}$, $I_B = 0$)	$V_{(BR)CEO}$	50	-	-	Vdc
DC Current Gain ($V_{CE} = 10\text{ V}$, $I_C = 5.0\text{ mA}$)	h_{FE}				
UMC2NT1G		60	100	-	
UMC3NT1G		35	60	-	
UMC5NT1G/T2G		80	140	-	
Collector-Emitter Saturation Voltage ($I_C = 10\text{ mA}$, $I_B = 0.3\text{ mA}$)	$V_{CE(SAT)}$	-	-	0.25	Vdc
Output Voltage (on) ($V_{CC} = 5.0\text{ V}$, $V_B = 2.5\text{ V}$, $R_L = 1.0\text{ k}\Omega$)	V_{OL}	-	-	0.2	Vdc
Output Voltage (off) ($V_{CC} = 5.0\text{ V}$, $V_B = 0.5\text{ V}$, $R_L = 1.0\text{ k}\Omega$)	V_{OH}	4.9	-	-	Vdc
Input Resistor	R1				$\text{k}\Omega$
UMC2NT1G		15.4	22	28.6	
UMC3NT1G		7.0	10	13	
UMC5NT1G/T2G		33	47	61	
Resistor Ratio	R1/R2				
UMC2NT1G		0.8	1.0	1.2	
UMC3NT1G		0.8	1.0	1.2	
UMC5NT1G/T2G		0.8	1.0	1.2	

UMC2NT1G, NSVUMC2NT1G, UMC3NT1G, NSVUMC3NT1G, UMC5NT1G, NSVUMC5NT2G

ORDERING INFORMATION

Device	Package	Shipping†
UMC2NT1G	SC-88A/SOT-353 (Pb-Free)	3,000 / Tape & Reel
NSVUMC2NT1G	SC-88A/SOT-353 (Pb-Free)	3,000 / Tape & Reel
UMC3NT1G	SC-88A/SOT-353 (Pb-Free)	3,000 / Tape & Reel
NSVUMC3NT1G	SC-88A/SOT-353 (Pb-Free)	3,000 / Tape & Reel
UMC3NT2G	SC-88A/SOT-353 (Pb-Free)	3,000 / Tape & Reel
UMC5NT1G	SC-88A/SOT-353 (Pb-Free)	3,000 / Tape & Reel
UMC5NT2G	SC-88A/SOT-353 (Pb-Free)	3,000 / Tape & Reel
NSVUMC5NT2G	SC-88A/SOT-353 (Pb-Free)	3,000 / Tape & Reel

†For information on tape and reel specifications, including part orientation and tape sizes, please refer to our Tape and Reel Packaging Specifications Brochure, BRD8011/D.

DEVICE MARKING AND RESISTOR VALUES

Device	Marking	Transistor 1 - PNP		Transistor 2 - NPN	
		R1 (K)	R2 (K)	R1 (K)	R2 (K)
UMC2NT1G, NSVUMC2NT1G	U2	22	22	22	22
UMC3NT1G, NSVUMC3NT1G	U3	10	10	10	10
UMC3NT2G	U3	10	10	10	10
UMC5NT1G	U5	4.7	10	47	47
UMC5NT2G, NSVUMC5NT2G	U5	4.7	10	47	47

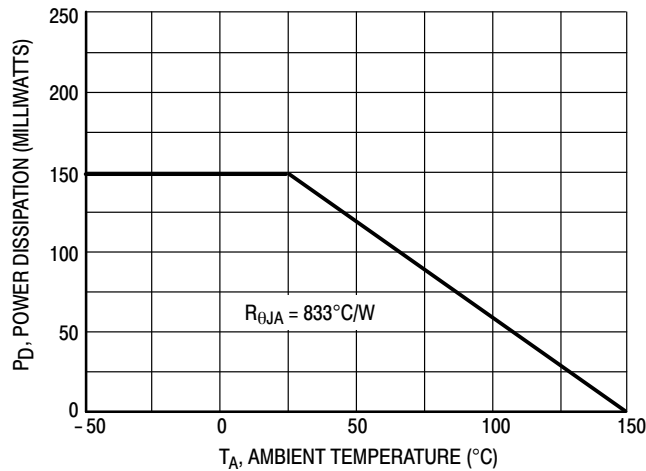

Figure 1. Derating Curve

**UMC2NT1G, NSVUMC2NT1G, UMC3NT1G, NSVUMC3NT1G, UMC5NT1G,
NSVUMC5NT2G**

TYPICAL ELECTRICAL CHARACTERISTICS — UMC2NT1G, NSVUMC2NT1G PNP TRANSISTOR



Figure 2. $V_{CE(sat)}$ versus I_C



Figure 3. DC Current Gain



Figure 4. Output Capacitance



Figure 5. Output Current versus Input Voltage

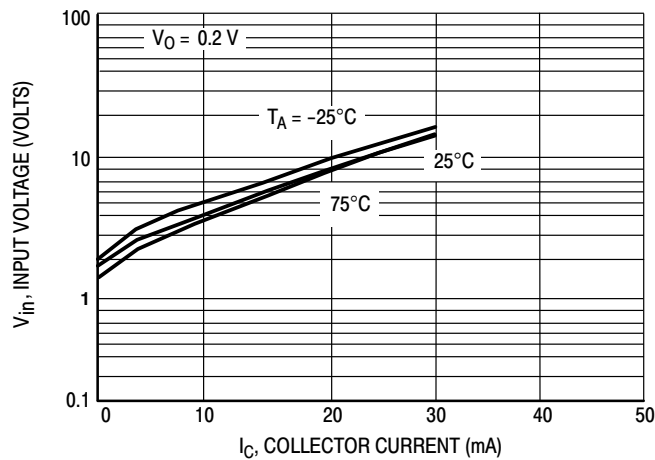

Figure 6. Input Voltage versus Output Current

UMC2NT1G, NSVUMC2NT1G, UMC3NT1G, NSVUMC3NT1G, UMC5NT1G, NSVUMC5NT2G

TYPICAL ELECTRICAL CHARACTERISTICS — UMC2NT1G, NSVUMC2NT1G NPN TRANSISTOR



Figure 7. $V_{CE(sat)}$ versus I_C



Figure 8. DC Current Gain



Figure 9. Output Capacitance



Figure 10. Output Current versus Input Voltage



Figure 11. Input Voltage versus Output Current

UMC2NT1G, NSVUMC2NT1G, UMC3NT1G, NSVUMC3NT1G, UMC5NT1G, NSVUMC5NT2G

TYPICAL ELECTRICAL CHARACTERISTICS — UMC3NT1G PNP TRANSISTOR

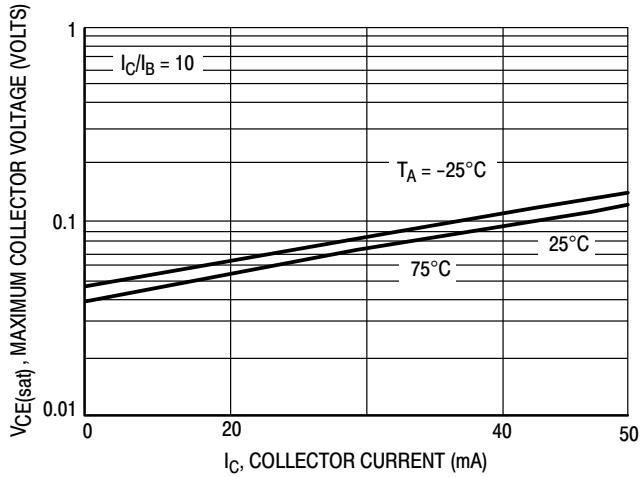

Figure 12. $V_{CE(sat)}$ versus I_C

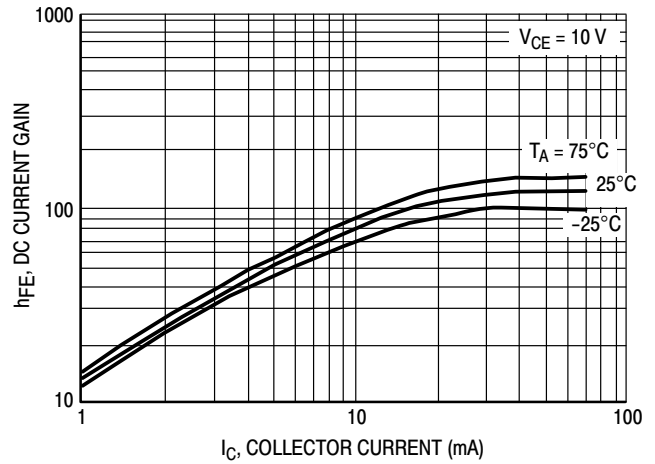

Figure 13. DC Current Gain

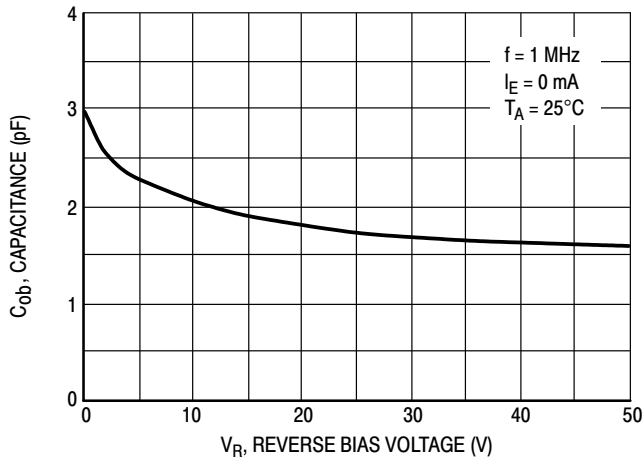

Figure 14. Output Capacitance

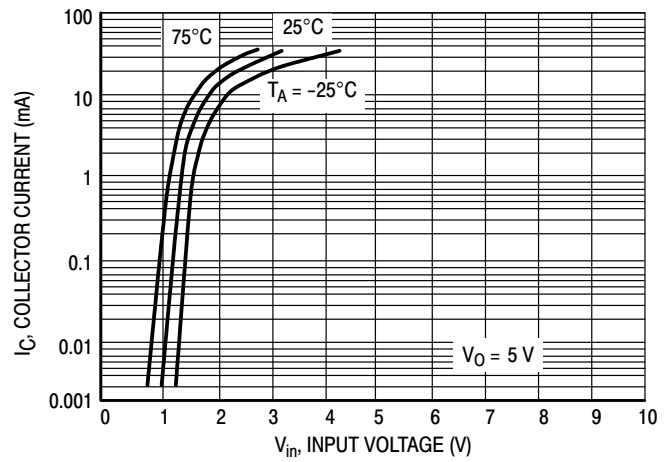

Figure 15. Output Current versus Input Voltage

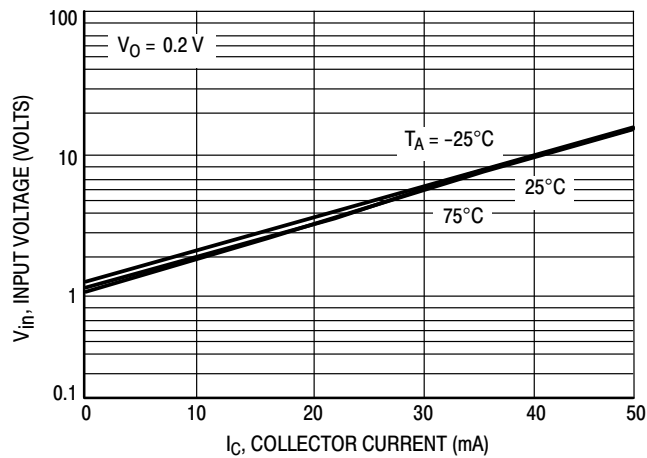

Figure 16. Input Voltage versus Output Current

UMC2NT1G, NSVUMC2NT1G, UMC3NT1G, NSVUMC3NT1G, UMC5NT1G, NSVUMC5NT2G

TYPICAL ELECTRICAL CHARACTERISTICS — UMC3NT1G NPN TRANSISTOR

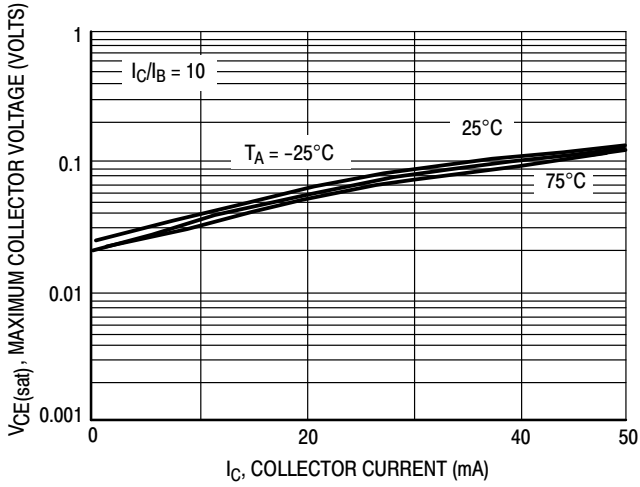

Figure 17. $V_{CE(sat)}$ versus I_C



Figure 18. DC Current Gain

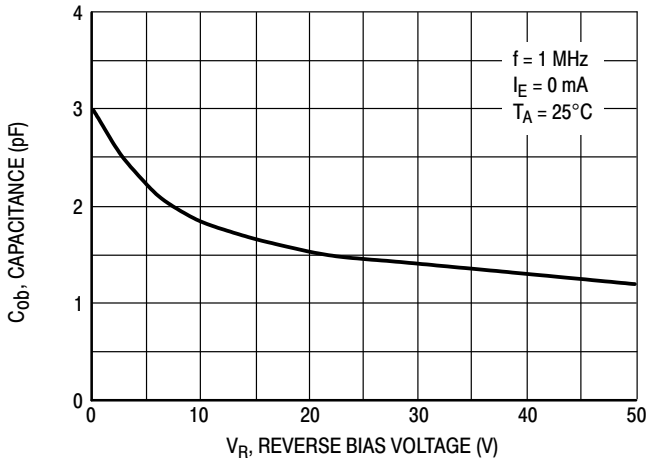

Figure 19. Output Capacitance

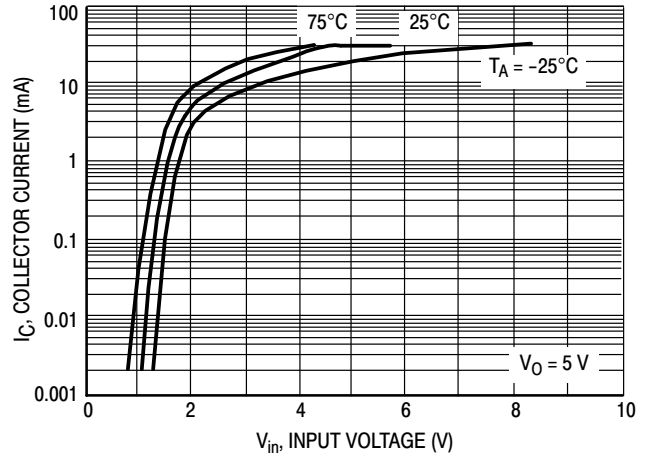

Figure 20. Output Current versus Input Voltage



Figure 21. Input Voltage versus Output Current

UMC2NT1G, NSVUMC2NT1G, UMC3NT1G, NSVUMC3NT1G, UMC5NT1G, NSVUMC5NT2G

TYPICAL ELECTRICAL CHARACTERISTICS — UMC5NT1G PNP TRANSISTOR



Figure 22. $V_{CE(sat)}$ versus I_C

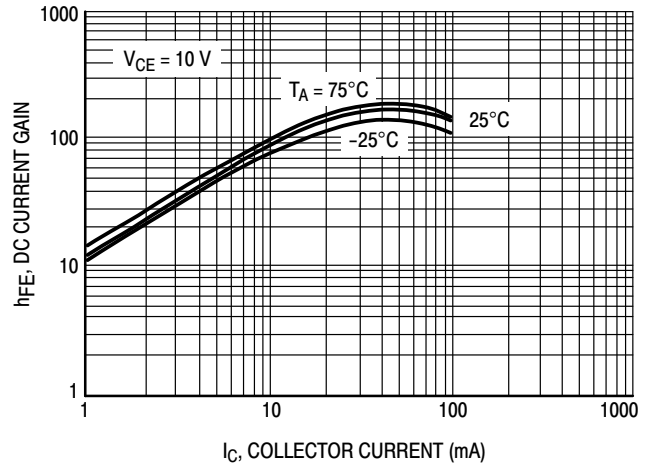

Figure 23. DC Current Gain



Figure 24. Output Capacitance

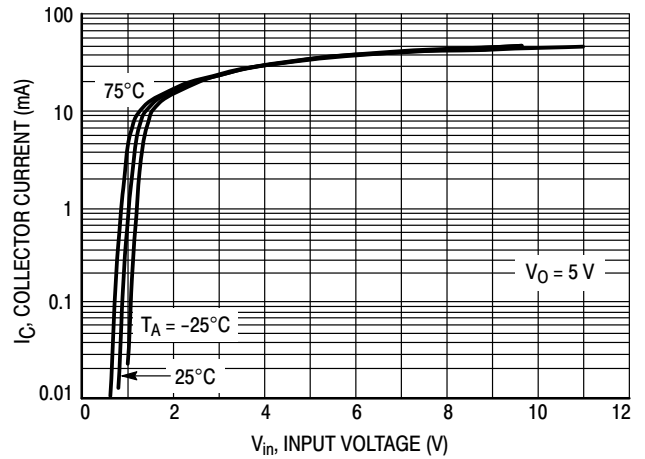

Figure 25. Output Current versus Input Voltage

UMC2NT1G, NSVUMC2NT1G, UMC3NT1G, NSVUMC3NT1G, UMC5NT1G, NSVUMC5NT2G

TYPICAL ELECTRICAL CHARACTERISTICS — UMC5NT1G NPN TRANSISTOR

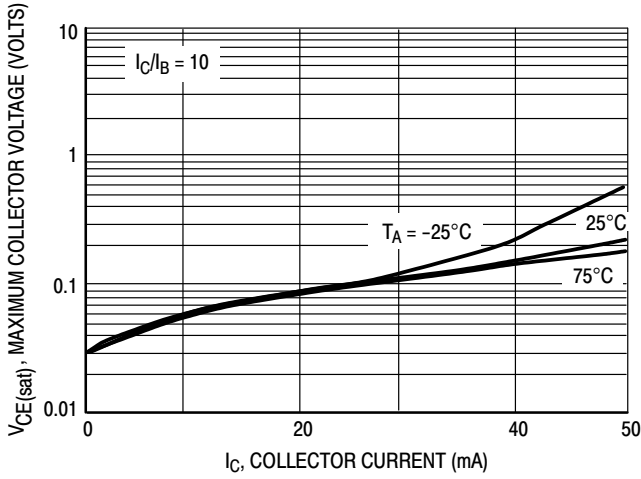

Figure 26. $V_{CE(sat)}$ versus I_C

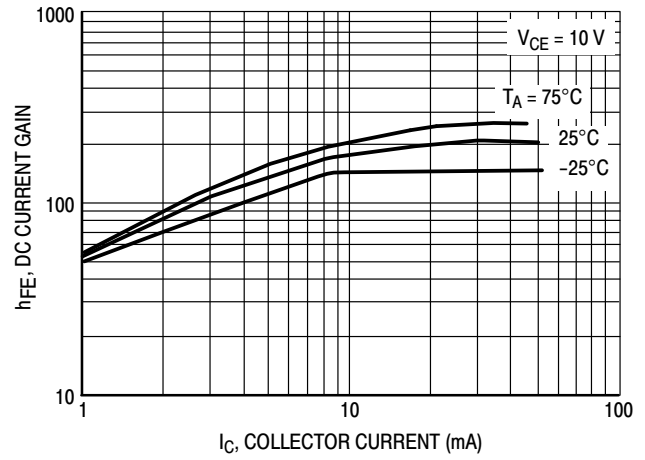

Figure 27. DC Current Gain



Figure 28. Output Capacitance



Figure 29. Output Current versus Input Voltage

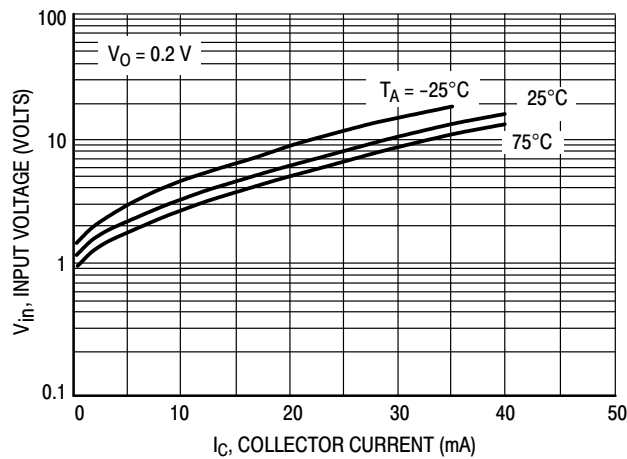

Figure 30. Input Voltage versus Output Current

UMC2NT1G, NSVUMC2NT1G, UMC3NT1G, NSVUMC3NT1G, UMC5NT1G, NSVUMC5NT2G

PACKAGE DIMENSIONS

SC-88A (SC-70-5/SOT-353)
CASE 419A-02
ISSUE K



NOTES:

1. DIMENSIONING AND TOLERANCING PER ANSI Y14.5M, 1982.
2. CONTROLLING DIMENSION: INCH.
3. 419A-01 OBSOLETE. NEW STANDARD 419A-02.
4. DIMENSIONS A AND B DO NOT INCLUDE MOLD FLASH, PROTRUSIONS, OR GATE BURRS.

DIM	INCHES		MILLIMETERS	
	MIN	MAX	MIN	MAX
A	0.071	0.087	1.80	2.20
B	0.045	0.053	1.15	1.35
C	0.031	0.043	0.80	1.10
D	0.004	0.012	0.10	0.30
G	0.026 BSC		0.65 BSC	
H	---	0.004	---	0.10
J	0.004	0.010	0.10	0.25
K	0.004	0.012	0.10	0.30
N	0.008 REF		0.20 REF	
S	0.079	0.087	2.00	2.20

STYLE 6:

- PIN 1. EMITTER 2
- BASE 2
- EMITTER 1
- COLLECTOR
- COLLECTOR 2/BASE 1

SOLDERING FOOTPRINT*



*For additional information on our Pb-Free strategy and soldering details, please download the ON Semiconductor Soldering and Mounting Techniques Reference Manual, SOLDERRM/D.

ON Semiconductor and are registered trademarks of Semiconductor Components Industries, LLC (SCILLC). SCILLC reserves the right to make changes without further notice to any products herein. SCILLC makes no warranty, representation or guarantee regarding the suitability of its products for any particular purpose, nor does SCILLC assume any liability arising out of the application or use of any product or circuit, and specifically disclaims any and all liability, including without limitation special, consequential or incidental damages. "Typical" parameters which may be provided in SCILLC data sheets and/or specifications can and do vary in different applications and actual performance may vary over time. All operating parameters, including "Typicals" must be validated for each customer application by customer's technical experts. SCILLC does not convey any license under its patent rights nor the rights of others. SCILLC products are not designed, intended, or authorized for use as components in systems intended for surgical implant into the body, or other applications intended to support or sustain life, or for any other application in which the failure of the SCILLC product could create a situation where personal injury or death may occur. Should Buyer purchase or use SCILLC products for any such unintended or unauthorized application, Buyer shall indemnify and hold SCILLC and its officers, employees, subsidiaries, affiliates, and distributors harmless against all claims, costs, damages, and expenses, and reasonable attorney fees arising out of, directly or indirectly, any claim of personal injury or death associated with such unintended or unauthorized use, even if such claim alleges that SCILLC was negligent regarding the design or manufacture of the part. SCILLC is an Equal Opportunity/Affirmative Action Employer. This literature is subject to all applicable copyright laws and is not for resale in any manner.

PUBLICATION ORDERING INFORMATION

LITERATURE FULFILLMENT:
Literature Distribution Center for ON Semiconductor
P.O. Box 5163, Denver, Colorado 80217 USA
Phone: 303-675-2175 or 800-344-3860 Toll Free USA/Canada
Fax: 303-675-2176 or 800-344-3867 Toll Free USA/Canada
Email: orderlit@onsemi.com

N. American Technical Support: 800-282-9855 Toll Free
USA/Canada
Europe, Middle East and Africa Technical Support:
Phone: 421 33 790 2910
Japan Customer Focus Center
Phone: 81-3-5817-1050

ON Semiconductor Website: www.onsemi.com
Order Literature: <http://www.onsemi.com/orderlit>
For additional information, please contact your local Sales Representative

Компания «Life Electronics» занимается поставками электронных компонентов импортного и отечественного производства от производителей и со складов крупных дистрибьюторов Европы, Америки и Азии.

С конца 2013 года компания активно расширяет линейку поставок компонентов по направлению коаксиальный кабель, кварцевые генераторы и конденсаторы (керамические, пленочные, электролитические), за счёт заключения дистрибьюторских договоров

Мы предлагаем:

- Конкуренеспособные цены и скидки постоянным клиентам.
- Специальные условия для постоянных клиентов.
- Подбор аналогов.
- Поставку компонентов в любых объемах, удовлетворяющих вашим потребностям.
- Приемлемые сроки поставки, возможна ускоренная поставка.
- Доставку товара в любую точку России и стран СНГ.
- Комплексную поставку.
- Работу по проектам и поставку образцов.
- Формирование склада под заказчика.
- Сертификаты соответствия на поставляемую продукцию (по желанию клиента).
- Тестирование поставляемой продукции.
- Поставку компонентов, требующих военную и космическую приемку.
- Входной контроль качества.
- Наличие сертификата ISO.

В составе нашей компании организован Конструкторский отдел, призванный помогать разработчикам, и инженерам.

Конструкторский отдел помогает осуществить:

- Регистрацию проекта у производителя компонентов.
- Техническую поддержку проекта.
- Защиту от снятия компонента с производства.
- Оценку стоимости проекта по компонентам.
- Изготовление тестовой платы монтаж и пусконаладочные работы.



Тел: +7 (812) 336 43 04 (многоканальный)

Email: org@lifeelectronics.ru