

Slide Potentiometer

Model PSxxM / PSxxL



Features:

- Molded element
- 100,000 cycle life
- Metal or plastic shaft options
- With/without LED illumination
- With/without dust cover
- RoHS compliant

Model Styles Available

Dual Gang Without LED	PSxxM
Single Gang With LED	PSxxL

Electrical

Resistance Range, Ohms	500 -1M
Standard Resistance Tolerance	± 20%
Resistance Tapers	A,B,C
Residual Resistance	Terminals 1 to 2: Less than 10 ohms Terminals 2 to 3: Less than 30 ohms
Input Voltage, Maximum	Linear B taper: 200 Vac Other tapers: 150 Vac
Power rating, Watts (Single Unit / Dual Unit)	Linear B taper: 20mm: 0.1W / 0.05W, 30mm: 0.2W / 0.1W 45mm: 0.25W / 0.125W, 60mm: 0.2W / 0.2W Other tapers: 20mm: 0.05W / 0.025W, 30mm: 0.1W / 0.05W 45mm: 0.125W / 0.06W, 60mm: 0.1W / 0.1W
Dielectric Strength	300Vac, 1 minute
Insulation Resistance, Minimum	10M ohms at 250Vdc/ 1 minute
Sliding Noise	Less than 100mV
Gang Error	±3dB (-40dB to 0dB)

Mechanical

Static Stop Strength, Minimum	5.0 Kg/cm
Operating Force	10gf to 100gf
Detent Slip-out force	30gf to 200gf

Durability

Sliding Life	100,000 cycles
--------------	----------------

General Note

TT Electronics reserves the right to make changes in product specification without notice or liability. All information is subject to TT Electronics' own data and is considered accurate at time of going to print.

TT Electronics | BI Technologies
4200 Bonita Place, Fullerton, CA USA 92835 | Ph: +1 714 447 2345
www.ttelectronics.com | sensors@ttelectronics.com

Slide Potentiometer

Model PSxxM / PSxxL



Ordering

Model PSxxM (Without LED)

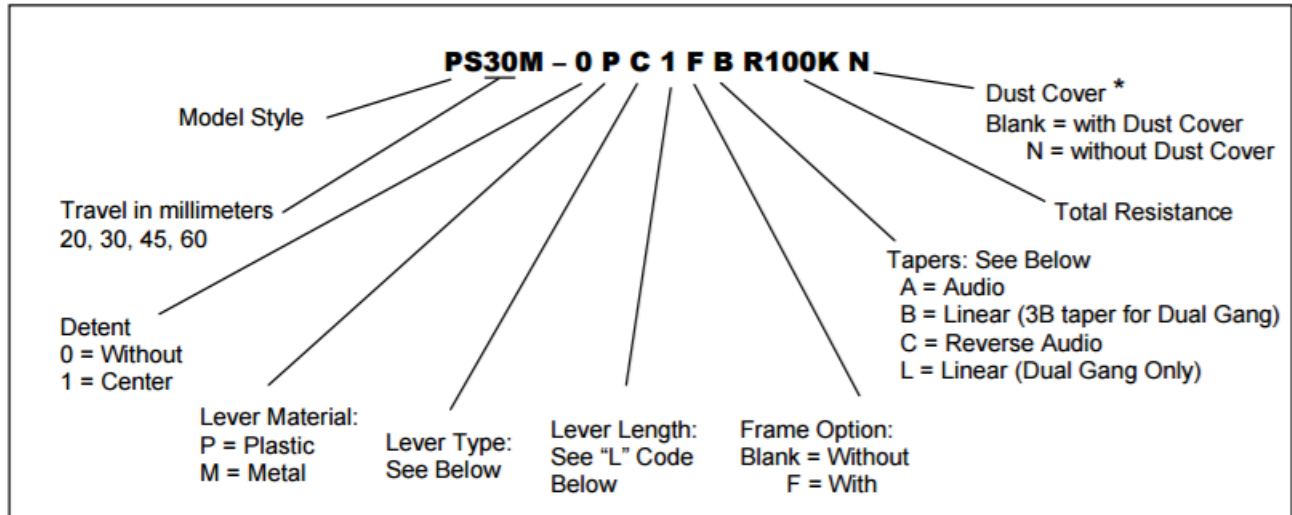

Model PSxxL (With LED)

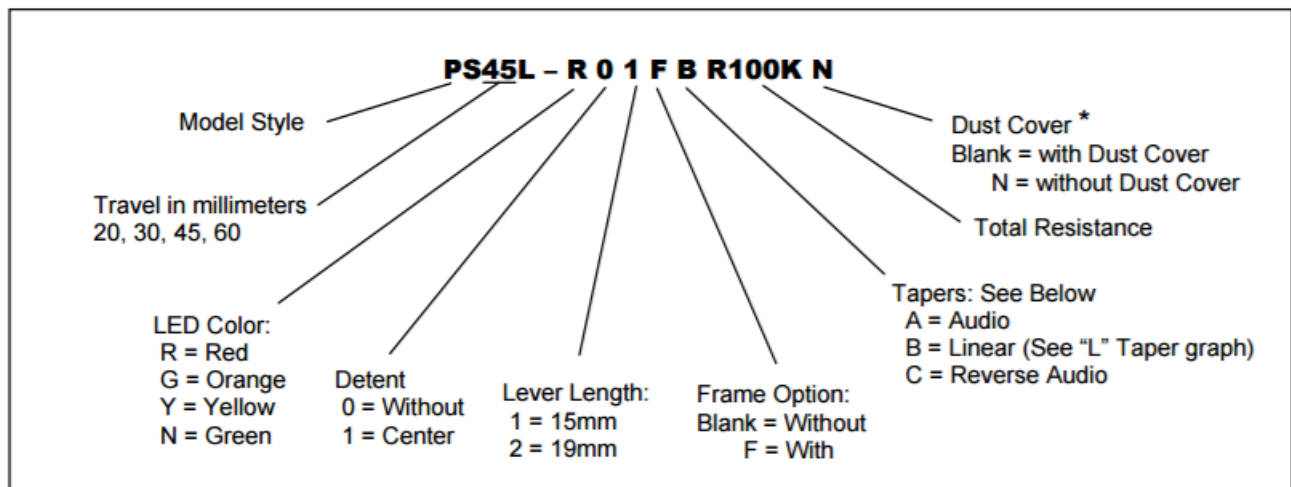

Standard Resistance Values, ohms

500	1K	2K	5K	10K	20K	50K	100K	200K	500K	1 MEG
-----	----	----	----	-----	-----	-----	------	------	------	-------

General Note

TT Electronics reserves the right to make changes in product specification without notice or liability. All information is subject to TT Electronics' own data and is considered accurate at time of going to print.

TT Electronics | BI Technologies
4200 Bonita Place, Fullerton, CA USA 92835 | Ph: +1 714 447 2345
www.ttelectronics.com | sensors@ttelectronics.com

Slide Potentiometer

Model PSxxM / PSxxL



Tapers

For Dual Gang units ONLY, the Standard Taper is a 3B taper
If Linear Taper is desired, use "L" taper option

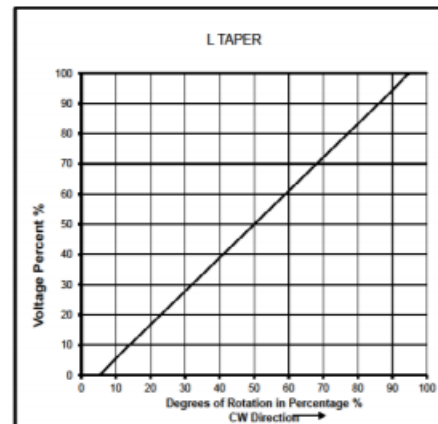
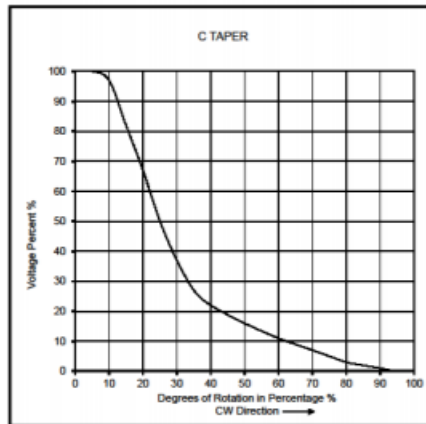
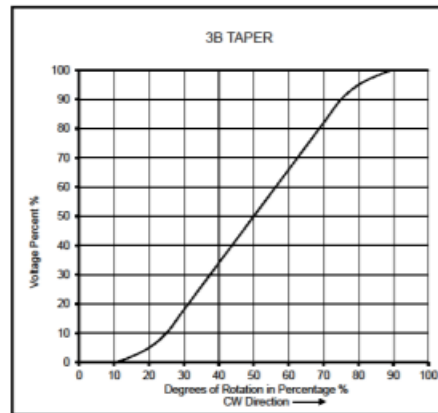
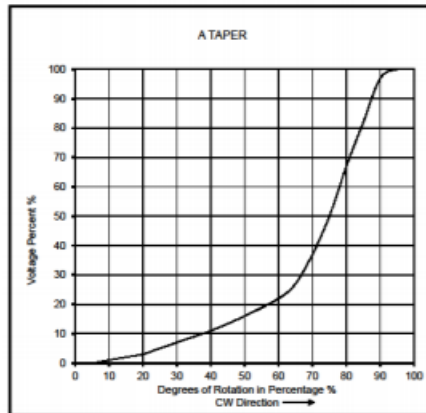

General Note

TT Electronics reserves the right to make changes in product specification without notice or liability. All information is subject to TT Electronics' own data and is considered accurate at time of going to print.

TT Electronics | BI Technologies
4200 Bonita Place, Fullerton, CA USA 92835 | Ph: +1 714 447 2345
www.ttelectronics.com | sensors@ttelectronics.com

Outline Drawings

Plastic Lever Types (For PSxxM Only)

E-Type		B-Type		C-Type		D-Type		
L	5.0	L	15	L	10 15	L	10 15 20	
CODE	1	CODE	1	CODE	1 2	CODE	1 2 3	

Dust Cover option not offered for levers less than 10 mm in length

Metal Lever Types (For PSxxM Only)

D-Type				C-Type				E-Type		
L	15	20	25	F	5	10	10	L	7.6	
CODE	1	2	3	CODE	1	2	3	4	CODE	1

*** Dust Cover option not offered for levers less than 10 mm in length**

Slide Potentiometer

Model PSxxM / PSxxL



Outline Drawings

Model PSxxM (Without LED)

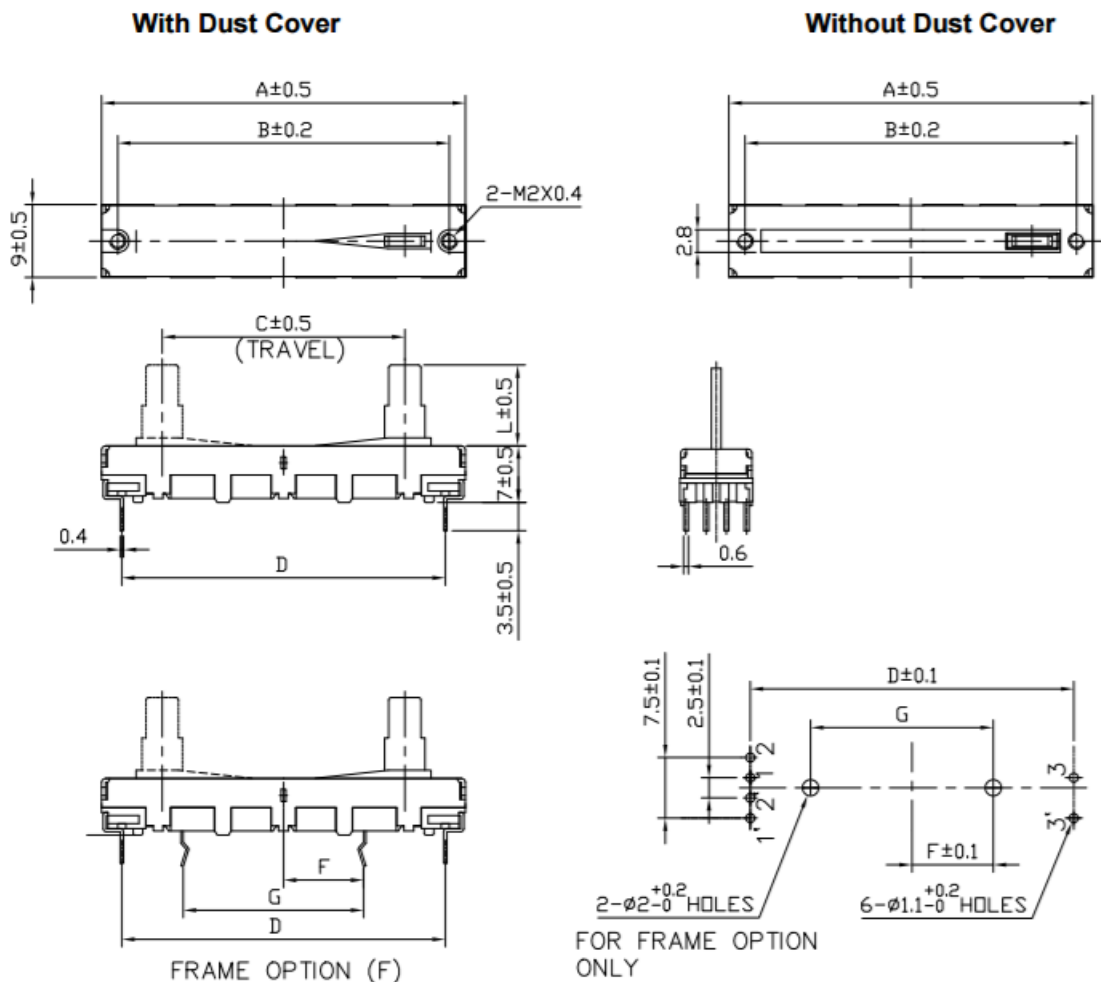

For PSxxM and PSxxL

MODEL	A	B	C	D	F	G
PS20M PS20L	35	31	20	30	5	12.5
PS30M PS30L	45	41	30	40	10	22.5
PS45M PS45L	60	56	45	55	15	32.5
PS60M PS60L	75	71	60	70	22.5	47.5

General Note

TT Electronics reserves the right to make changes in product specification without notice or liability. All information is subject to TT Electronics' own data and is considered accurate at time of going to print.

TT Electronics | BI Technologies
 4200 Bonita Place, Fullerton, CA USA 92835 | Ph: +1 714 447 2345
 www.ttelectronics.com | sensors@ttelectronics.com

Slide Potentiometer

Model PSxxM / PSxxL



Outline Drawings

Model PSxxL (With LED)

With Dust Cover

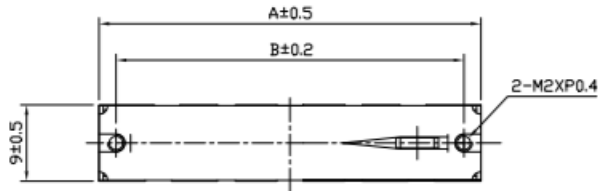

Without Dust Cover

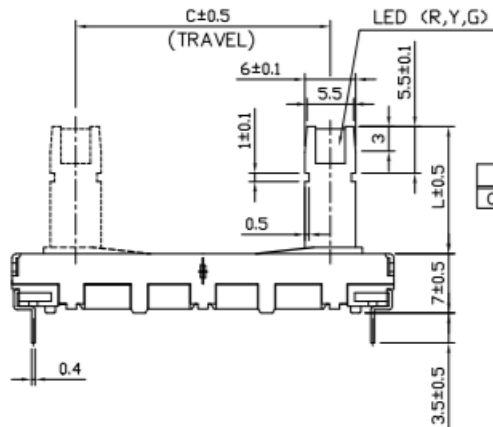
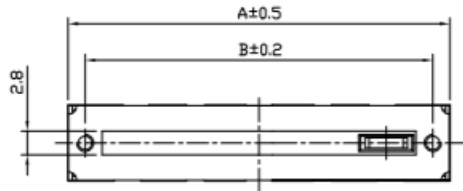

L	15	19
CODE	1	2

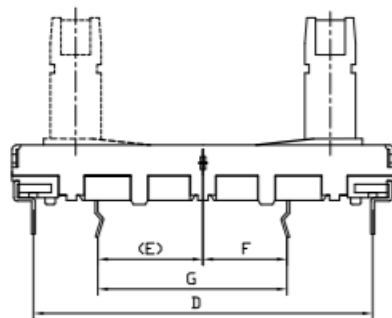
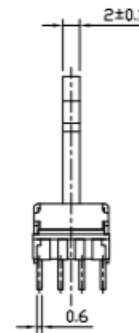

FRAME OPTION (F)

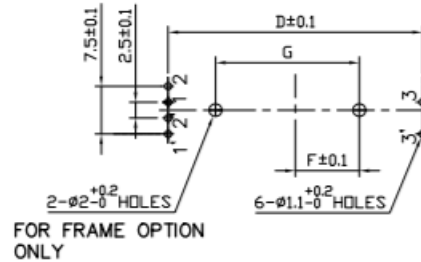

PSxxL (Single gang with LED)

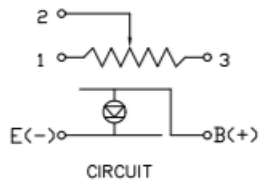

PSxxM (Dual gang)

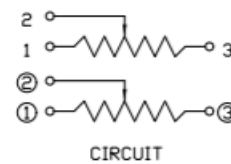

General Note

TT Electronics reserves the right to make changes in product specification without notice or liability. All information is subject to TT Electronics' own data and is considered accurate at time of going to print.

TT Electronics | BI Technologies
4200 Bonita Place, Fullerton, CA USA 92835 | Ph: +1 714 447 2345
www.ttelectronics.com | sensors@ttelectronics.com

Компания «Life Electronics» занимается поставками электронных компонентов импортного и отечественного производства от производителей и со складов крупных дистрибьюторов Европы, Америки и Азии.

С конца 2013 года компания активно расширяет линейку поставок компонентов по направлению коаксиальный кабель, кварцевые генераторы и конденсаторы (керамические, пленочные, электролитические), за счёт заключения дистрибьюторских договоров

Мы предлагаем:

- Конкурентоспособные цены и скидки постоянным клиентам.
- Специальные условия для постоянных клиентов.
- Подбор аналогов.
- Поставку компонентов в любых объемах, удовлетворяющих вашим потребностям.
- Приемлемые сроки поставки, возможна ускоренная поставка.
- Доставку товара в любую точку России и стран СНГ.
- Комплексную поставку.
- Работу по проектам и поставку образцов.
- Формирование склада под заказчика.
- Сертификаты соответствия на поставляемую продукцию (по желанию клиента).
- Тестирование поставляемой продукции.
- Поставку компонентов, требующих военную и космическую приемку.
- Входной контроль качества.
- Наличие сертификата ISO.

В составе нашей компании организован Конструкторский отдел, призванный помогать разработчикам, и инженерам.

Конструкторский отдел помогает осуществить:

- Регистрацию проекта у производителя компонентов.
- Техническую поддержку проекта.
- Защиту от снятия компонента с производства.
- Оценку стоимости проекта по компонентам.
- Изготовление тестовой платы монтаж и пусконаладочные работы.



Тел: +7 (812) 336 43 04 (многоканальный)
Email: org@lifeelectronics.ru