

## TruStability® Board Mount Pressure Sensors: NSC Series— Uncompensated/Unamplified Uncompensated/Unamplified Millivolt Analog Output, 1 psi to 150 psi (60 mbar to 10 bar)



### DESCRIPTION

The TruStability® NSC Series-Uncompensated/Unamplified is a piezoresistive silicon pressure sensor offering a ratiometric analog output for reading pressure over the specified full scale pressure span and temperature range.

The NSC Series is both unamplified and uncompensated. It offers infinite resolution on the pressure signal. Frequency response is limited only by the end user's system. The sensor will operate as specified from -40 °C to 85 °C [-40 °F to 185 °F].

These products are ideal for those customers who want to do their own compensation, calibration, and amplification in order to make use of the maximum resolution of the bare sensor output, leveraging a custom algorithm required for the application.

The NSC Series allows customers the flexibility of self-calibration while still benefiting from the industry-leading stability, accuracy, and repeatability that the Honeywell TruStability® Pressure Sensors provide.

Additionally, the NSC Series offers numerous package styles and mounting options, making it easier for the device manufacturer to integrate the product into their application.

These sensors measure absolute, differential, and gage pressures. The absolute versions have an internal vacuum reference and an output value proportional to absolute pressure. Differential versions allow application of pressure to either side of the sensing diaphragm. Gage versions are referenced to atmospheric pressure and provide an output proportional to pressure variations from atmosphere.

The NSC Series sensors are intended for use with non-corrosive, non-ionic gases, such as air and other dry gases and for non-corrosive, non-ionic liquids. All products are designed and manufactured according to ISO 9001.

### FEATURES AND BENEFITS (★=competitive differentiator)

- ★ Industry-leading long-term stability: Even after long-term use and thermal extremes, these sensors perform substantially better relative to stability than any other pressure sensor available in the industry today:
  - Minimizes system calibration needs and maximizes system performance
  - Helps support system uptime by eliminating the need to service or replace the sensor during its application life
- ★ Industry-leading accuracy: Extremely tight accuracy of  $\pm 0.25\%$  FSS BFSL:
  - Reduces software needed to correct system inaccuracies, minimizing system design time
  - Supports system accuracy and warranty requirements
  - Helps to optimize system uptime

# TruStability® Board Mount Pressure Sensors: NSC Series— Uncompensated/Unamplified

## FEATURES AND BENEFITS (★=competitive differentiator) (continued)

- ★ Industry-leading flexibility:
  - Modular, flexible design with numerous package styles, pressure ports, and options simplify integration into the device manufacturer's application
  - Single side wet media option allows the end customer to use one port of the sensor with condensing humidity or directly with non-corrosive liquid media
- ★ Small size: Miniature 10 mm x 10 mm [0.39 in x 0.39 in] package is very small when compared to most board mount pressure sensors
  - Occupies less area on the PCB
  - Typically allows for easy placement on crowded PCBs or in small devices
- ★ Repeatability: Provides excellent repeatability, high accuracy and reliability under many demanding conditions
- Extremely low power consumption (operating supply voltage as low as 1.8 Vdc):
  - Reduces power consumption
  - Provides extended battery life
  - Promotes energy efficiency
- Low operating voltage
- Sensitive: Meets specified pressure level requirements, providing enhanced sensitivity and accuracy over the range
- Virtually insensitive to mounting orientation, allowing for flexibility of use within the application
- Ratiometric analog output
- Infinite resolution
- Fast response time
- RoHS compliant
- Absolute, differential and gage types
- Pressure ranges from 1 psi to 150 psi (60 mbar to 10 bar)
- Also available in the HSC Series and the SSC Series which are fully compensated and calibrated with amplified analog or digital I<sup>2</sup>C or SPI outputs

## POTENTIAL APPLICATIONS (★=focus applications)

### Medical:

- Respiratory breathing circuits:
  - Nebulizers
  - Spirometers
  - Patient monitoring
- Flow/pressure control:
  - Therapeutic hospital beds
- Gas collection/delivery:
  - ★ Hospital gas supply
  - Oxygen concentrators
- Precise sampling/gas flow:
  - ★ Blood analysis
  - ★ Gas chromatography
  - ★ Analytical instrument sampling systems

### Industrial:

- Pneumatic components:
  - ★ Valves
  - ★ Pumps
  - ★ Actuators
- Pneumatic systems:
  - ★ HVAC transmitters
  - ★ Automated pneumatic assembly equipment
  - ★ Pneumatic operator control systems
- Gas collection/delivery:
  - ★ Industrial gas supply
- Precise sampling/gas flow:
  - ★ Barometry
  - ★ Gas chromatography
  - ★ Analytical instrument sampling systems

Table 1. Absolute Maximum Ratings<sup>1</sup>

Parameter	Min.	Max.	Unit
Supply voltage (V <sub>supply</sub> )	-12.0	12.0	Vdc
ESD susceptibility (human body model)	3	–	kV
Storage temperature	-40 [-40]	85 [185]	°C [°F]
Soldering time and temperature:			
Lead solder temperature (SIP, DIP)	4 s max. at 250 °C [482 °F]		
Peak reflow temperature (SMT)	15 s max. at 250 °C [482 °F]		

# Uncompensated/Unamplified Millivolt Analog Output

**Table 2. Operating Specifications**

Parameter	Min.	Typ.	Max.	Unit
Supply voltage ( $V_{\text{supply}}$ ) <sup>2</sup>	1.8	5.0 <sup>3</sup>	12.0	Vdc
Supply current (at 5.0 Vdc supply)	–	1.5	2	mA
Specified temperature range <sup>4</sup>	-40 [-40]	–	85 [185]	°C [°F]
Startup time	–	–	5	ms
Accuracy <sup>5</sup>	–	–	±0.25	%FSS BFSL <sup>6</sup>

**Table 3. Environmental Specifications**

Parameter	Characteristic
Humidity	0% to 95% RH, non-condensing
Vibration	MIL-STD-202F, Curve AK (20.7 g random)
Shock	MIL-STD-202F, Method 213B, Condition F
Life <sup>7</sup>	1 million pressure cycles minimum
Solder reflow	J-STD-020-C

**Table 4. Wetted Materials<sup>8</sup>**

Parameter	Port 1 (Pressure Port)	Port 2 (Reference Port)
Covers	high temperature polyamide	high temperature polyamide
Substrate	alumina ceramic	alumina ceramic
Adhesives	epoxy, RTV	epoxy, RTV
Electronic components	ceramic, silicon	silicon, glass, gold, solder

**Notes:**

1. Absolute maximum ratings are the extreme limits the device will withstand without damage.
2. Ratiometricity of the sensor (the ability of the device output to scale to the supply voltage) is achieved within the specified operating voltage.
3. Incorrect application of supply voltage or ground to the wrong pin may cause electrical failure.
4. The specified temperature range is the temperature range over which the sensor will produce an output proportional to pressure within the specified performance limits.
5. Accuracy: The maximum deviation in output from a Best Fit Straight Line (BFSL) fitted to the output measured over the pressure range at 25 °C [77 °F]. Includes all errors due to pressure non-linearity, pressure hysteresis, and non-repeatability.
6. Full Scale Span (FSS) is the algebraic difference between the output signal measured at the maximum ( $P_{\text{max}}$ ) and minimum ( $P_{\text{min}}$ ) limits of the pressure range. (See Figure 1 for ranges.)
7. Life may vary depending on specific application in which sensor is utilized.
8. Contact Honeywell Customer Service for detailed material information.

## CAUTION

### PRODUCT DAMAGE

- Ensure liquid media is applied to Port 1 only; Port 2 is not compatible with liquids.
- Ensure liquid media contains no particulates. All TruStability® sensors are dead-ended devices. Particulates can accumulate inside the sensor, causing damage or affecting sensor output.
- Recommend that the sensor be positioned with Port 1 facing downwards; any particulates in the system are less likely to enter and settle within the pressure sensor if it is in this position.
- Ensure liquid media does not create a residue when dried; build-up inside the sensor may affect sensor output. Rinsing of a dead-ended sensor is difficult and has limited effectiveness for removing residue.
- Ensure liquid media are compatible with wetted materials. Non-compatible liquid media will degrade sensor performance and may lead to sensor failure.

**Failure to comply with these instructions may result in product damage.**

# TruStability® Board Mount Pressure Sensors: NSC Series— Uncompensated/Unamplified

Figure 1. Nomenclature and Order Guide

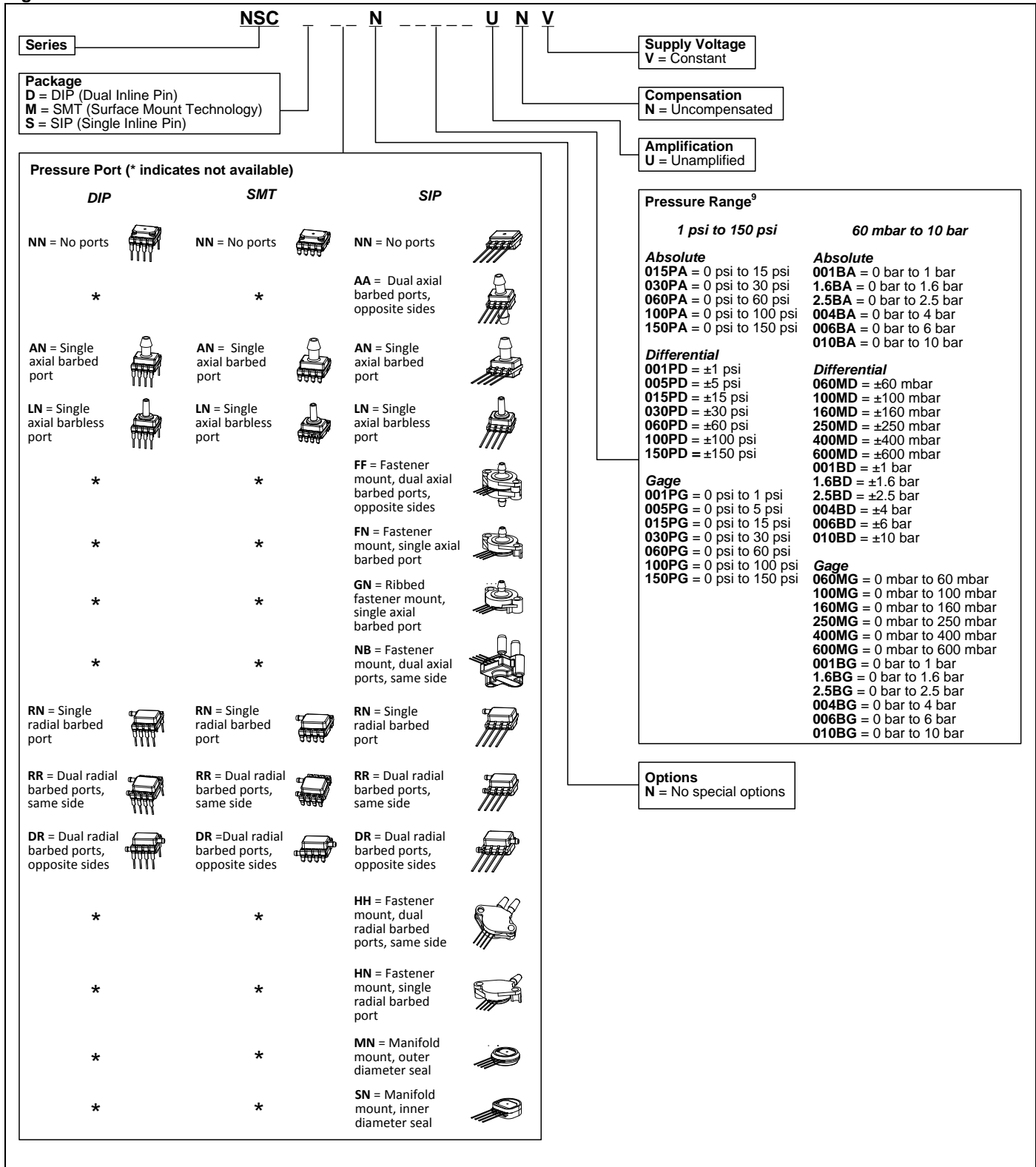

**Note:**

9. See Table 5 for an explanation of sensor pressure types.

# Uncompensated/Unamplified Millivolt Analog Output

Figure 2. Completed Catalog Listing Example

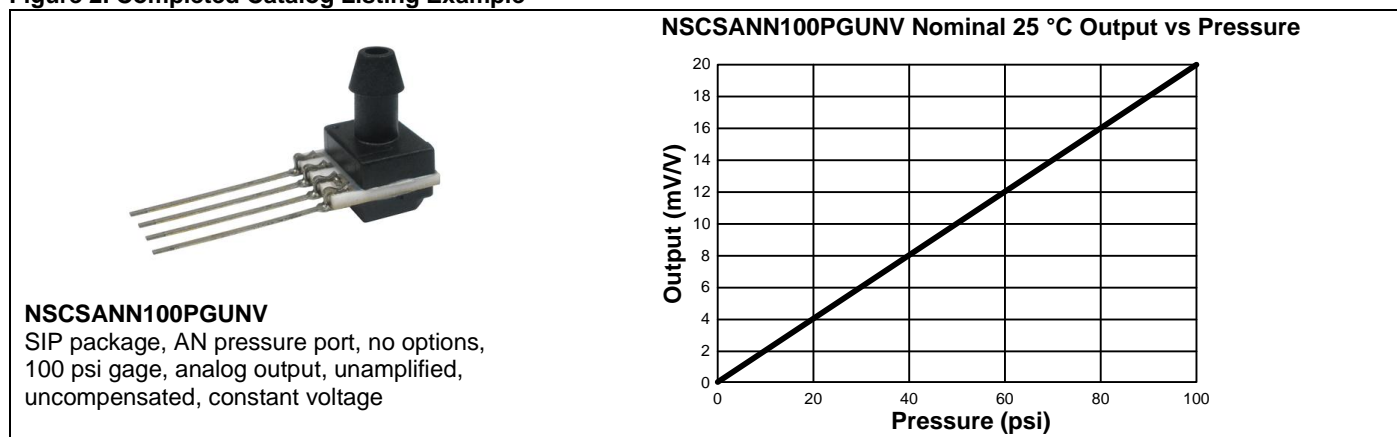

Table 5. Pressure Types

Pressure Type	Description
Absolute	Output is proportional to the difference between applied pressure and a built-in reference to vacuum. Reference pressure is absolute zero pressure (full vacuum).
Differential	Output is proportional to the difference between the pressures applied to each port. (Port 1 – Port 2) Reference pressure is Port 1 = Port 2.
Gage	Output is proportional to the difference between applied pressure and atmospheric (ambient) pressure. Reference pressure is atmospheric pressure.

Table 6. Pressure Range Specifications for 1 psi to 150 psi

Pressure Range (see Figure 1)	Pressure Range		Unit	Over Pressure	Burst Pressure	Common Mode Pressure	Offset <sup>10</sup> (mV/V)		Sensitivity (mV/V/Full Scale Span)			TCO <sup>11</sup> (%FSS/25 °C)			TCS <sup>12</sup> (%FSS/25 °C)			Bridge Resistance <sup>13</sup> (kOhm)			TCR <sup>14</sup> (-40 °C to 25 °C) (ppm/°C)		TCR <sup>15</sup> (25 °C to 85 °C) (ppm/°C)		Long-term Stability (1000 hr, 25 °C [77 °F]) (%FSS)
	Pmin.	Pmax.					Min.	Max.	Min.	Nom.	Max.	Min.	Nom.	Max.	Min.	Nom.	Max.	Min.	Nom.	Max.	Min.	Max.	Min.	Max.	
<b>Absolute</b>																									
015PA	0	15	psi	30	60	N/A	-6.0	6.0	10.3	15.0	19.7	-3.6	0.0	3.6	-7.5	-5.0	-3.0	2.6	3.5	4.4	500	1500	1500	2500	±0.25%
030PA	0	30	psi	60	120	N/A	-6.0	6.0	9.9	14.8	19.7	-3.8	0.0	3.8	-7.5	-5.0	-3.0	2.6	3.5	4.4	500	1500	1500	2500	±0.25%
060PA	0	60	psi	120	250	N/A	-6.0	6.0	10.7	15.2	19.7	-3.5	0.0	3.5	-7.5	-5.0	-3.0	2.6	3.5	4.4	500	1500	1500	2500	±0.25%
100PA	0	100	psi	250	250	N/A	-6.0	6.0	9.1	12.6	16.1	-4.1	0.0	4.1	-7.5	-5.0	-3.0	2.6	3.5	4.4	500	1500	1500	2500	±0.25%
150PA	0	150	psi	250	250	N/A	-6.0	6.0	13.6	18.9	24.2	-2.8	0.0	2.8	-7.5	-5.0	-3.0	2.6	3.5	4.4	500	1500	1500	2500	±0.25%
<b>Differential</b>																									
001PD	-1	1	psi	5	20	150	-8.5	3.5	9.0	13.0	17.0	-1.1	0.5	1.1	-6.3	-5.0	-3.8	4	5	6	1200	2200	2200	3200	±0.35%
005PD	-5	5	psi	20	40	150	-8.5	3.5	20.0	30.0	40.0	-0.6	0.2	0.6	-6.3	-5.0	-3.8	4	5	6	1200	2200	2200	3200	±0.35%
015PD	-15	15	psi	30	60	150	-7.0	5.3	20.7	31.0	41.4	-0.6	0.3	0.5	-6.0	-5.0	-3.8	2.4	3	5.5	1200	2200	2200	3200	±0.25%
030PD	-30	30	psi	60	120	150	-7.0	5.3	31.0	41.4	51.7	-0.3	0.2	0.3	-6.0	-5.0	-3.8	2.4	3	5.5	1200	2200	2200	3200	±0.25%
060PD	-60	60	psi	120	250	250	-7.0	5.3	34.8	41.4	48.0	-0.3	0.2	0.3	-6.0	-5.0	-3.8	2.4	3	5.5	1200	2200	2200	3200	±0.25%
100PD	-100	100	psi	250	250	250	-7.0	5.3	29.0	34.5	40.0	-0.3	0.3	0.3	-6.0	-5.0	-3.8	2.4	3	5.5	1200	2200	2200	3200	±0.25%
150PD	-150	150	psi	250	250	250	-7.0	5.3	43.4	51.7	60.0	-0.2	0.2	0.2	-6.0	-5.0	-3.8	2.4	3	5.5	1200	2200	2200	3200	±0.25%
<b>Gage</b>																									
001PG	0	1	psi	5	20	150	-8.5	3.5	4.5	6.5	8.5	-2.2	1.0	2.2	-6.3	-5.0	-3.8	4	5	6	1200	2200	2200	3200	±0.35%
005PG	0	5	psi	20	40	150	-8.5	3.6	10.0	15.0	20.0	-1.0	0.4	1.0	-6.3	-5.0	-3.8	4	5	6	1200	2200	2200	3200	±0.35%
015PG	0	15	psi	30	60	150	-7.0	5.3	10.3	15.5	20.7	-1.0	0.6	1.0	-6.0	-5.0	-3.8	2.4	3	5.5	1200	2200	2200	3200	±0.25%
030PG	0	30	psi	60	120	150	-7.0	5.3	15.5	20.7	25.9	-0.6	0.4	0.6	-6.0	-5.0	-3.8	2.4	3	5.5	1200	2200	2200	3200	±0.25%
060PG	0	60	psi	120	250	250	-7.0	5.3	17.4	20.7	24.0	-0.6	0.4	0.6	-6.0	-5.0	-3.8	2.4	3	5.5	1200	2200	2200	3200	±0.25%
100PG	0	100	psi	250	250	250	-7.0	5.3	14.5	17.2	20.0	-0.7	0.5	0.7	-6.0	-5.0	-3.8	2.4	3	5.5	1200	2200	2200	3200	±0.25%
150PG	0	150	psi	250	250	250	-7.0	5.3	21.7	25.9	30.0	-0.6	0.3	0.6	-6.0	-5.0	-3.8	2.4	3	5.5	1200	2200	2200	3200	±0.25%

# TruStability® Board Mount Pressure Sensors: NSC Series— Uncompensated/Unamplified

Table 7. Pressure Range Specifications for 60 mbar to 10 bar

Pressure Range (see Figure 1)	Pressure Range		Unit	Over Pressure	Burst Pressure	Common Mode Pressure	Offset <sup>10</sup> (mV/V)		Sensitivity (mV/V/Full Scale Span)			TCO <sup>11</sup> (%FSS/25 °C)			TCS <sup>12</sup> (%FSS/25 °C)			Bridge Resistance <sup>13</sup> (kOhm)			TCR <sup>14</sup> (-40 °C to 25 °C) (ppm/°C)		TCR <sup>15</sup> (25 °C to 85 °C) (ppm/°C)		Long-term Stability (1000 hr, 25 °C [77 °F]) (%FSS)
	Pmin.	Pmax.					Min.	Max.	Min.	Nom.	Max.	Min.	Nom.	Max.	Min.	Nom.	Max.	Min.	Nom.	Max.	Min.	Max.	Min.	Max.	
<b>Absolute</b>																									
001BA	0	1	bar	2	4	N/A	-6.0	6.0	10.0	14.5	19.0	-3.8	0.0	3.8	-7.5	-5.0	-3.0	2.6	3.5	4.4	500	1500	1500	2500	±0.25%
1.6BA	0	1.6	bar	4.1	8	N/A	-6.0	6.0	7.7	11.4	15.2	-4.9	0.0	4.9	-7.5	-5.0	-3.0	2.6	3.5	4.4	500	1500	1500	2500	±0.25%
2.5BA	0	2.5	bar	4.1	8	N/A	-6.0	6.0	12.0	17.9	23.8	-3.1	0.0	3.1	-7.5	-5.0	-3.0	2.6	3.5	4.4	500	1500	1500	2500	±0.25%
004BA	0	4	bar	8	17	N/A	-6.0	6.0	10.3	14.7	19.0	-3.6	0.0	3.6	-7.5	-5.0	-3.0	2.6	3.5	4.4	500	1500	1500	2500	±0.25%
006BA	0	6	bar	17	17	N/A	-6.0	6.0	7.9	11.0	14.0	-4.8	0.0	4.8	-7.5	-5.0	-3.0	2.6	3.5	4.4	500	1500	1500	2500	±0.25%
010BA	0	10	bar	17	17	N/A	-6.0	6.0	13.2	18.3	23.4	-2.9	0.0	2.9	-7.5	-5.0	-3.0	2.6	3.5	4.4	500	1500	1500	2500	±0.25%
<b>Differential</b>																									
060MD	-60	60	mbar	340	1380	10000	-8.5	3.5	7.8	11.3	14.8	-1.3	0.6	1.3	-6.3	-5.0	-3.8	4	5	6	1200	2200	2220	3200	±0.35%
100MD	-100	100	mbar	340	1380	10000	-8.5	3.5	13.1	18.9	24.7	-0.8	0.3	0.8	-6.3	-5.0	-3.8	4	5	6	1200	2200	2220	3200	±0.35%
160MD	-160	160	mbar	340	1380	10000	-8.5	3.5	20.9	30.2	39.4	-0.5	0.2	0.5	-6.3	-5.0	-3.8	4	5	6	1200	2200	2220	3200	±0.35%
250MD	-250	250	mbar	1380	2760	10000	-8.5	3.5	14.5	21.8	29.0	-0.7	0.3	0.7	-6.3	-5.0	-3.8	4	5	6	1200	2200	2220	3200	±0.35%
400MD	-400	400	mbar	1380	2760	10000	-7.0	5.3	23.2	34.8	46.4	-0.4	0.2	0.4	-6.3	-5.0	-3.8	2.4	3	5.5	1200	2200	2220	3200	±0.35%
600MD	-600	600	mbar	2060	4100	10000	-7.0	5.3	12.0	18.0	24.0	-0.8	0.5	0.8	-6.0	-5.0	-3.8	2.4	3	5.5	1200	2200	2220	3200	±0.25%
001BD	-1	1	bar	2	4	10	-7.0	5.3	20.0	30.0	40.0	-0.6	0.3	0.5	-6.0	-5.0	-3.8	2.4	3	5.5	1200	2200	2220	3200	±0.25%
1.6BD	-1.6	1.6	bar	4.1	8	10	-7.0	5.3	24.0	32.0	40.0	-0.4	0.3	0.4	-6.0	-5.0	-3.8	2.4	3	5.5	1200	2200	2220	3200	±0.25%
2.5BD	-2.5	2.5	bar	4.1	8	10	-7.0	5.3	37.5	50.0	62.5	-0.3	0.2	0.3	-6.0	-5.0	-3.8	2.4	3	5.5	1200	2200	2220	3200	±0.25%
004BD	-4.0	4.0	bar	8	17	17	-7.0	5.3	33.6	40.0	46.4	-0.3	0.2	0.3	-6.0	-5.0	-3.8	2.4	3	5.5	1200	2200	2220	3200	±0.25%
006BD	-6.0	6.0	bar	17	17	17	-7.0	5.3	25.2	30.0	34.8	-0.4	0.3	0.4	-6.0	-5.0	-3.8	2.4	3	5.5	1200	2200	2220	3200	±0.25%
010BD	-10.0	10	bar	17	17	17	-7.0	5.3	42.0	50.0	58.0	-0.2	0.1	0.2	-6.0	-5.0	-3.8	2.4	3	5.5	1200	2200	2220	3200	±0.25%
<b>Gage</b>																									
060MG	0	60	mbar	340	1380	10000	-8.5	3.5	3.9	5.7	7.4	-2.6	1.1	2.6	-6.3	-5.0	-3.8	4	5	6	1200	2200	2220	3200	±0.35%
100MG	0	100	mbar	340	1380	10000	-8.5	3.5	6.5	9.4	12.3	-1.5	0.7	1.5	-6.3	-5.0	-3.8	4	5	6	1200	2200	2220	3200	±0.35%
160MG	0	160	mbar	340	1380	10000	-8.5	3.5	10.4	15.1	19.7	-1.0	0.4	1.0	-6.3	-5.0	-3.8	4	5	6	1200	2200	2220	3200	±0.35%
250MG	0	250	mbar	1380	2760	10000	-8.5	3.5	7.3	10.9	14.5	-1.4	0.6	1.4	-6.3	-5.0	-3.8	4	5	6	1200	2200	2220	3200	±0.35%
400MG	0	400	mbar	1380	2760	10000	-7.0	5.3	11.6	17.4	23.2	-0.9	0.4	0.9	-6.3	-5.0	-3.8	2.4	3	5.5	1200	2200	2220	3200	±0.35%
600MG	0	600	mbar	2060	4100	10000	-7.0	5.3	6.0	9.0	12.0	-1.7	1.0	1.7	-8.0	-5.0	-3.8	2.4	3	5.5	1200	2200	2220	3200	±0.35%
001BG	0	1	bar	2	4	10	-7.0	5.3	10.0	15.0	20.0	-1.0	0.6	1.0	-8.0	-5.0	-3.8	2.4	3	5.5	1200	2200	2220	3200	±0.25%
1.6BG	0	1.6	bar	4.1	8	10	-7.0	5.3	12.0	16.0	20.0	-0.8	0.5	0.8	-8.0	-5.0	-3.8	2.4	3	5.5	1200	2200	2220	3200	±0.25%
2.5BG	0	2.5	bar	4.1	8	10	-7.0	5.3	18.8	25.0	31.3	-0.6	0.4	0.5	-8.0	-5.0	-3.8	2.4	3	5.5	1200	2200	2220	3200	±0.25%
004BG	0	4	bar	8	17	17	-7.0	5.3	16.8	20.0	23.2	-0.6	0.4	0.6	-8.0	-5.0	-3.8	2.4	3	5.5	1200	2200	2220	3200	±0.25%
006BG	0	6	bar	17	17	17	-7.0	5.3	12.6	15.0	17.4	-0.8	0.6	0.8	-8.0	-5.0	-3.8	2.4	3	5.5	1200	2200	2220	3200	±0.25%
010BG	0	10	bar	17	17	17	-7.0	5.3	21.0	25.0	29.0	-0.5	0.4	0.5	-8.0	-5.0	-3.8	2.4	3	5.5	1200	2200	2220	3200	±0.25%

**Notes:**

10. Offset: The output signal obtained when the reference pressure is applied to all available pressure ports. Also known as “null” or “zero”.
11. TCO (Thermal Effect on Offset): The deviation in offset due to changes in temperature over the specified temperature range, relative to offset measured at 25 °C.
12. TCS (Thermal Effect on Span): The deviation in full scale span due to changes in temperature over the specified temperature range, relative to full scale span measured at 25 °C.
13. Bridge Resistance: The resistance of the device measured across the power supply leads.
14. TCR (Thermal Coefficient of Resistance): The deviation in bridge resistance due to changes in temperature over the specified temperature range, relative to bridge resistance measured at 25 °C.

Table 8. Pinout for DIP and SMT Packages

Output Type	Pin 1	Pin 2	Pin 3	Pin 4	Pin 5	Pin 6	Pin 7	Pin 8
analog	GND	OUTPUT+	V <sub>supply</sub>	OUTPUT-	NC	NC	NC	NC

Table 9. Pinout for SIP Packages

Output Type	Pin 1	Pin 2	Pin 3	Pin 4
analog	GND	OUTPUT+	V <sub>supply</sub>	OUTPUT-

# Uncompensated/Unamplified Millivolt Analog Output

Figure 3. DIP Pressure Port Dimensional Drawings (For reference only: mm [in])

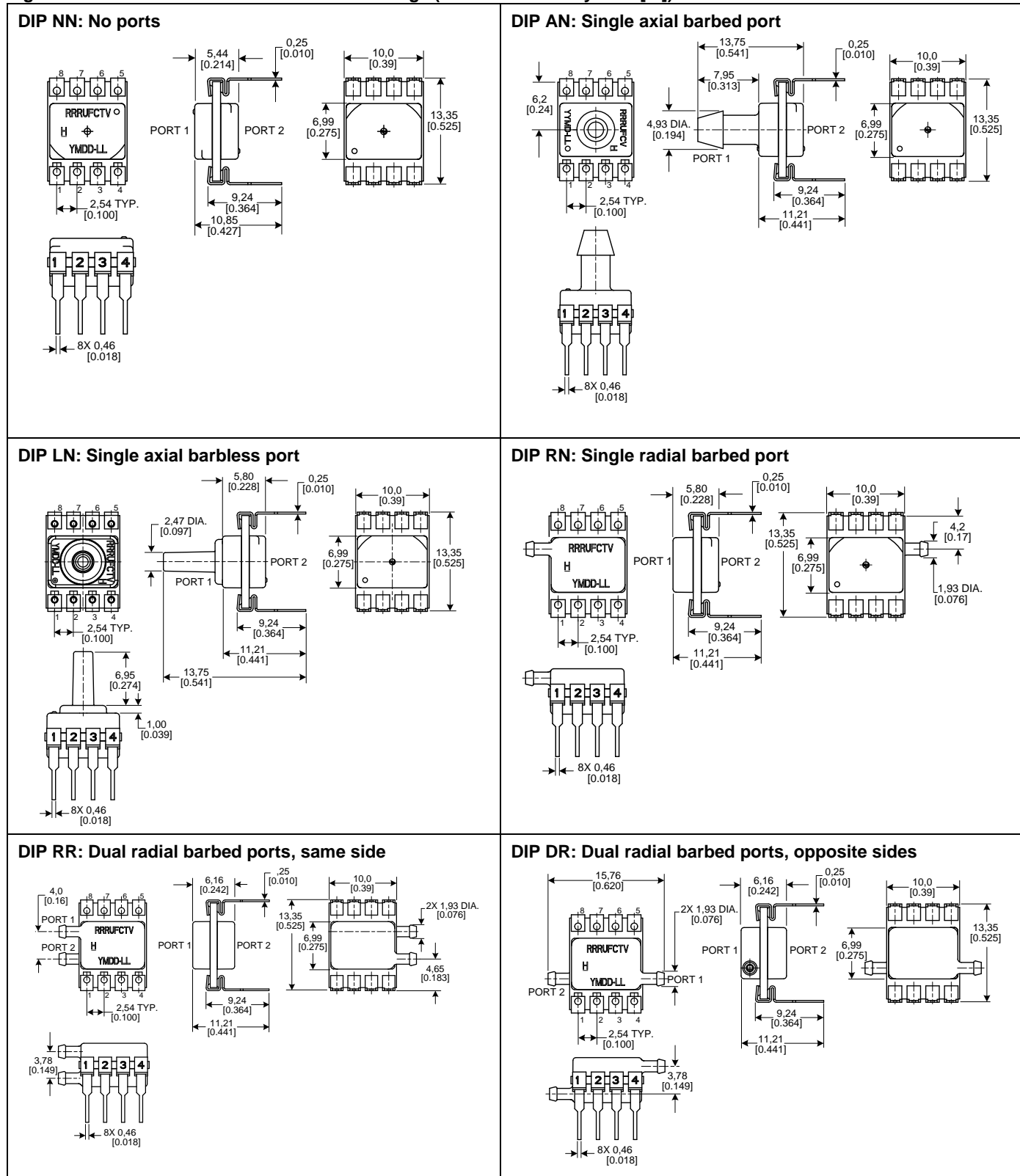

# TruStability® Board Mount Pressure Sensors: NSC Series— Uncompensated/Unamplified

Figure 4. SMT Pressure Port Dimensional Drawings (For reference only: mm [in])

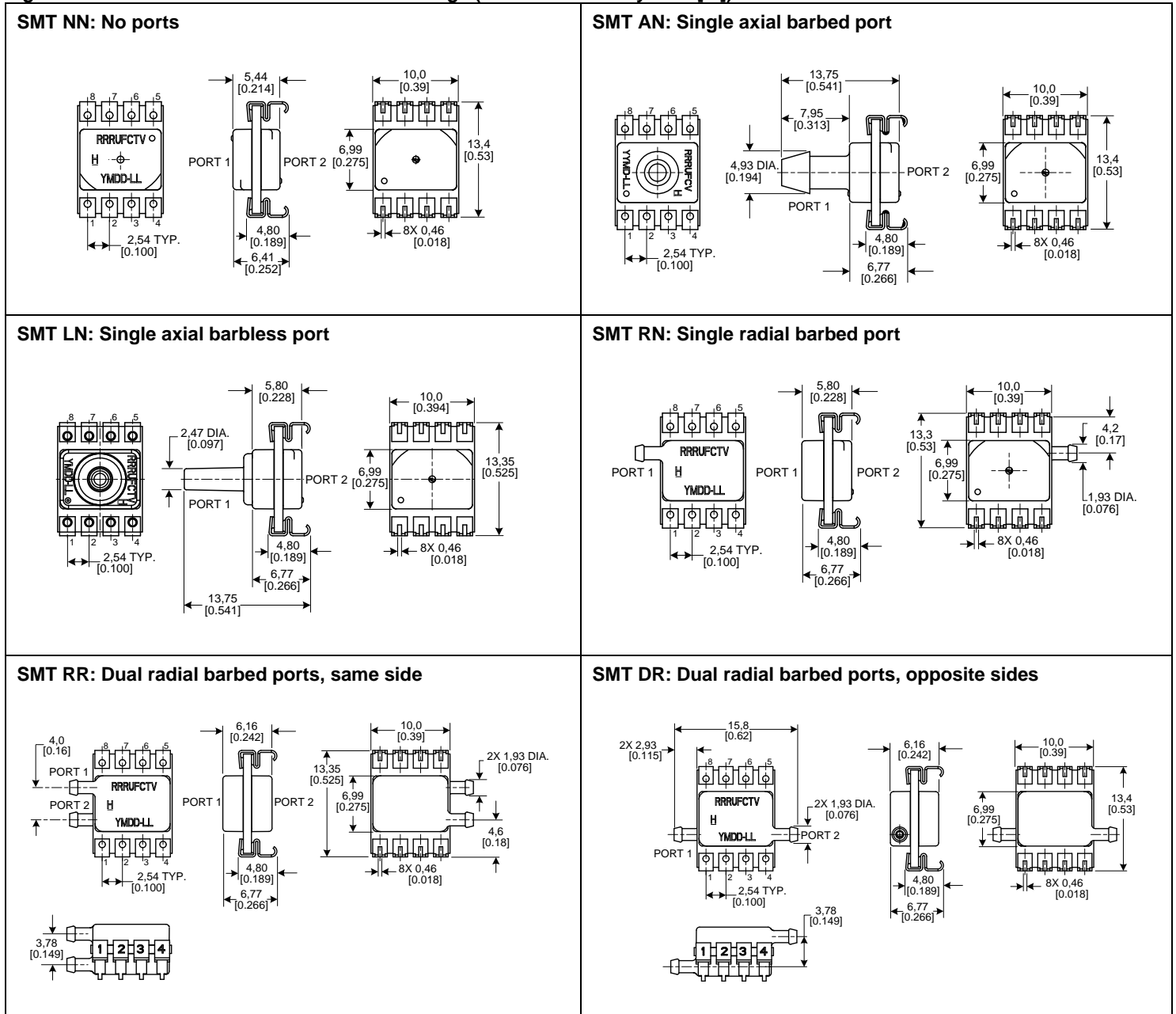



# Uncompensated/Unamplified Millivolt Analog Output

Figure 5. SIP Package Dimensional Drawings (For reference only: mm [in])

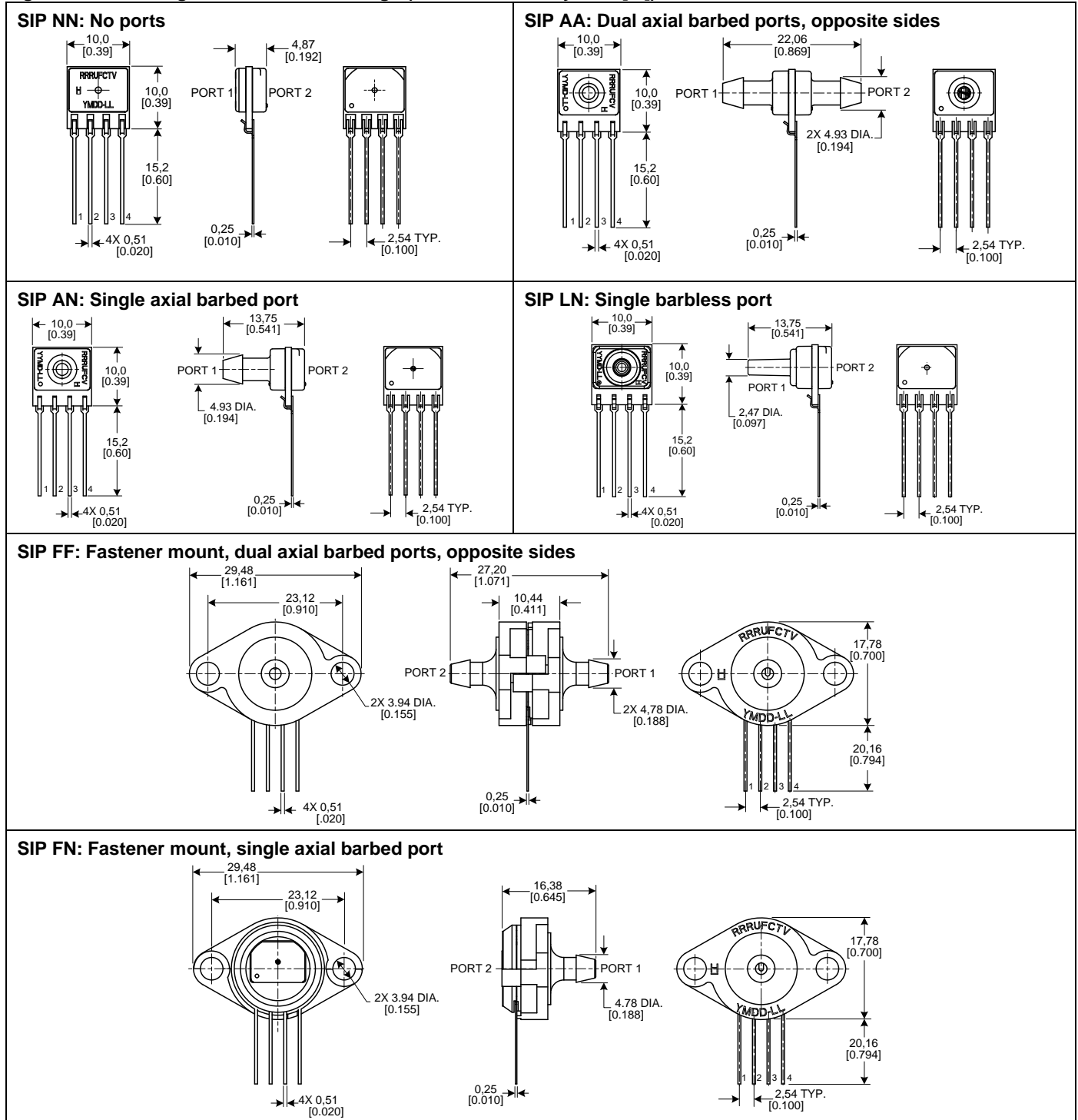

# TruStability® Board Mount Pressure Sensors: NSC Series— Uncompensated/Unamplified

Figure 5. SIP Package Dimensional Drawings (continued)

## SIP GN: Ribbed fastener mount, single axial barbed port

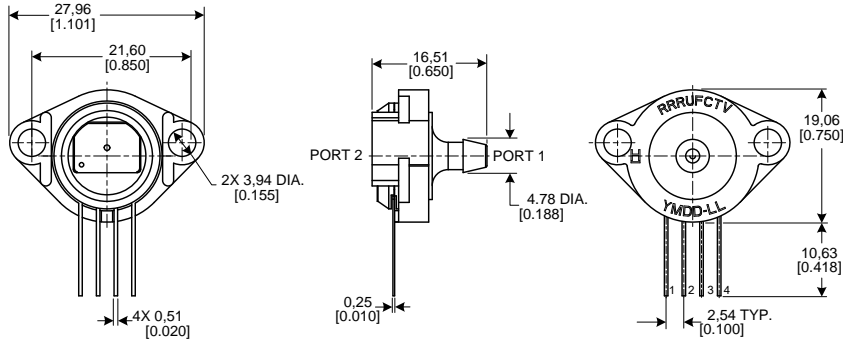

## SIP NB: Fastener mount, dual axial ports, same side

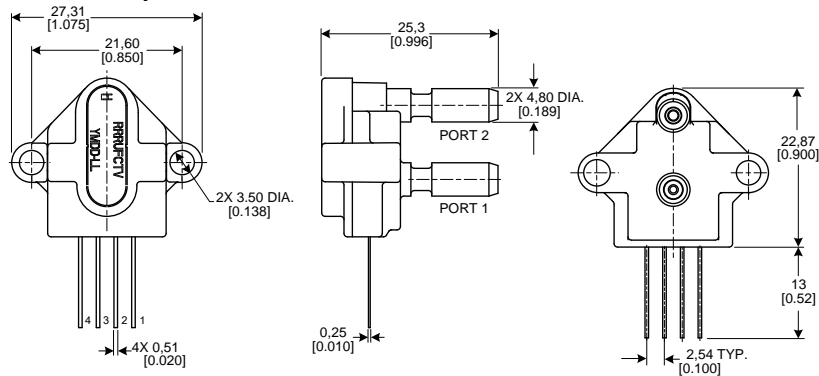

## SIP RN: Single radial barbed port

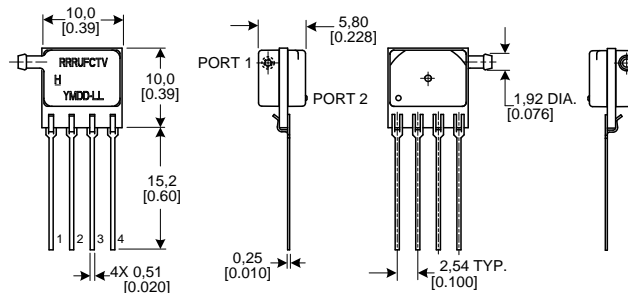

## SIP RR: Dual radial barbed ports, same side

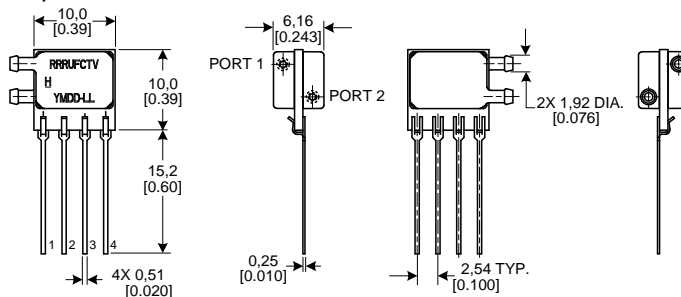

# Uncompensated/Unamplified Millivolt Analog Output

Figure 5. SIP Package Dimensional Drawings (continued)

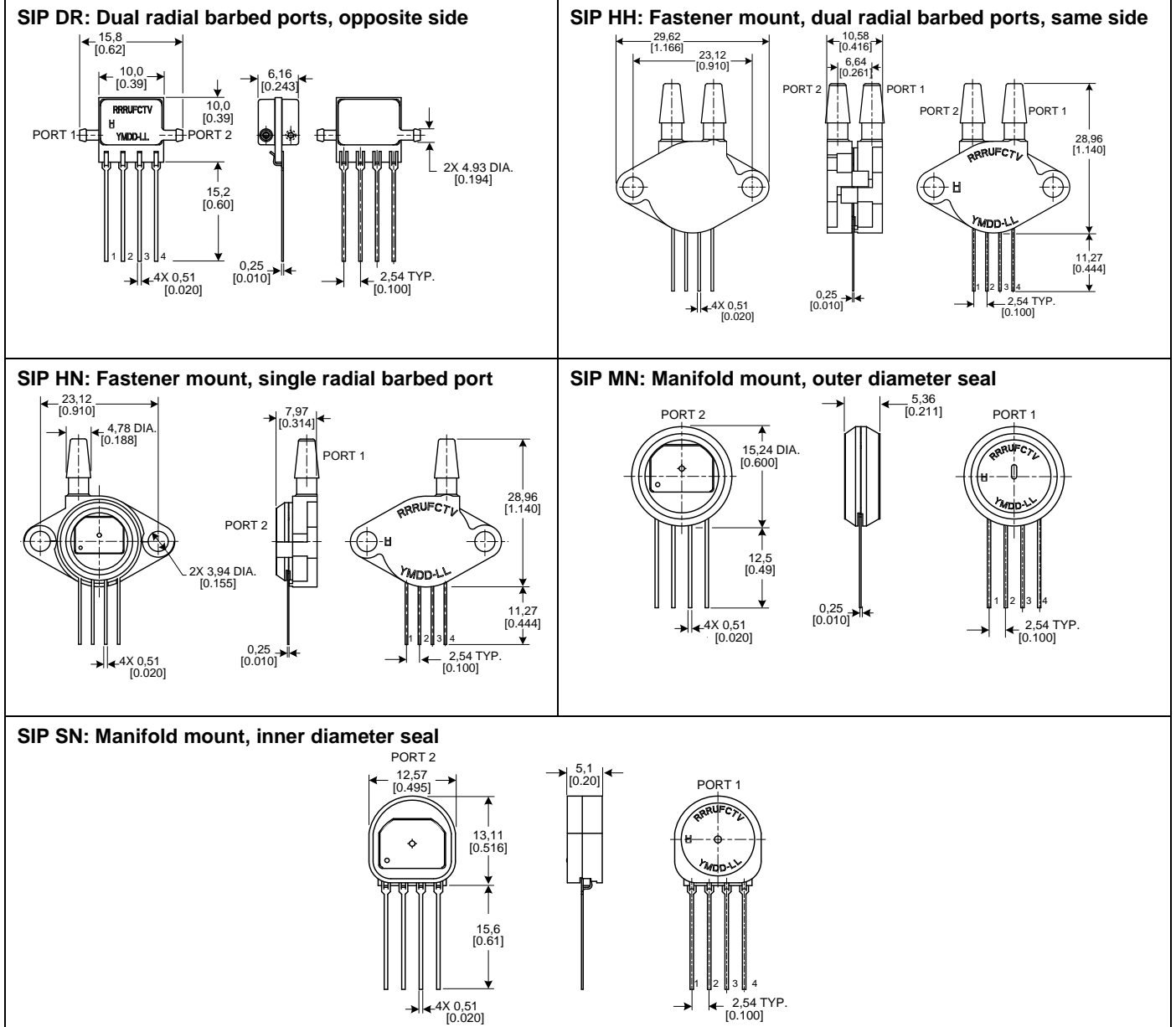

## **WARNING**

### **PERSONAL INJURY**

DO NOT USE these products as safety or emergency stop devices or in any other application where failure of the product could result in personal injury.

**Failure to comply with these instructions could result in death or serious injury.**

### **WARRANTY/REMEDY**

Honeywell warrants goods of its manufacture as being free of defective materials and faulty workmanship. Honeywell's standard product warranty applies unless agreed to otherwise by Honeywell in writing; please refer to your order acknowledgement or consult your local sales office for specific warranty details. If warranted goods are returned to Honeywell during the period of coverage, Honeywell will repair or replace, at its option, without charge those items it finds defective. **The foregoing is buyer's sole remedy and is in lieu of all other warranties, expressed or implied, including those of merchantability and fitness for a particular purpose. In no event shall Honeywell be liable for consequential, special, or indirect damages.**

While we provide application assistance personally, through our literature and the Honeywell web site, it is up to the customer to determine the suitability of the product in the application.

Specifications may change without notice. The information we supply is believed to be accurate and reliable as of this printing. However, we assume no responsibility for its use.

## **WARNING**

### **MISUSE OF DOCUMENTATION**

- The information presented in this product sheet is for reference only. DO NOT USE this document as a product installation guide.
- Complete installation, operation, and maintenance information is provided in the instructions supplied with each product.

**Failure to comply with these instructions could result in death or serious injury.**

### **SALES AND SERVICE**

Honeywell serves its customers through a worldwide network of sales offices, representatives and distributors. For application assistance, current specifications, pricing or name of the nearest Authorized Distributor, contact your local sales office or:

**E-mail:** [info.sc@honeywell.com](mailto:info.sc@honeywell.com)

**Internet:** [www.honeywell.com/sensing](http://www.honeywell.com/sensing)

### **Phone and Fax:**

Asia Pacific	+65 6355-2828; +65 6445-3033 Fax
Europe	+44 (0) 1698 481481; +44 (0) 1698 481676 Fax
Latin America	+1-305-805-8188; +1-305-883-8257 Fax
USA/Canada	+1-800-537-6945; +1-815-235-6847 +1-815-235-6545 Fax

Sensing and Control  
Honeywell  
1985 Douglas Drive North  
Golden Valley, MN 55422  
[www.honeywell.com/sensing](http://www.honeywell.com/sensing)

008221-1-EN IL50 GLO Printed in USA  
July 2011  
© 2011 Honeywell International Inc.

# Honeywell

Компания «Life Electronics» занимается поставками электронных компонентов импортного и отечественного производства от производителей и со складов крупных дистрибьюторов Европы, Америки и Азии.

С конца 2013 года компания активно расширяет линейку поставок компонентов по направлению коаксиальный кабель, кварцевые генераторы и конденсаторы (керамические, пленочные, электролитические), за счёт заключения дистрибьюторских договоров

Мы предлагаем:

- Конкурентоспособные цены и скидки постоянным клиентам.
- Специальные условия для постоянных клиентов.
- Подбор аналогов.
- Поставку компонентов в любых объемах, удовлетворяющих вашим потребностям.
- Приемлемые сроки поставки, возможна ускоренная поставка.
- Доставку товара в любую точку России и стран СНГ.
- Комплексную поставку.
- Работу по проектам и поставку образцов.
- Формирование склада под заказчика.
- Сертификаты соответствия на поставляемую продукцию (по желанию клиента).
- Тестирование поставляемой продукции.
- Поставку компонентов, требующих военную и космическую приемку.
- Входной контроль качества.
- Наличие сертификата ISO.

В составе нашей компании организован Конструкторский отдел, призванный помогать разработчикам, и инженерам.

Конструкторский отдел помогает осуществить:

- Регистрацию проекта у производителя компонентов.
- Техническую поддержку проекта.
- Защиту от снятия компонента с производства.
- Оценку стоимости проекта по компонентам.
- Изготовление тестовой платы монтаж и пусконаладочные работы.



Тел: +7 (812) 336 43 04 (многоканальный)

Email: [org@lifeelectronics.ru](mailto:org@lifeelectronics.ru)