

# LEB100F

LEB 100 F -05 24 -□

① ② ③ ④ ⑤ ⑥

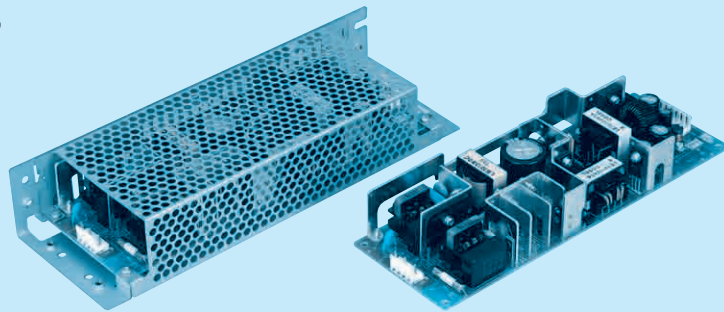

Recommended EMI/EMC Filter  
NAC-06-472



High voltage pulse noise type : NAP series  
Low leakage current type : NAM series  
\*The EMI/EMC Filter is recommended to connect with several devices.

- ① Series name
- ② Output wattage
- ③ Universal input
- ④ V1 Output voltage
- ⑤ V2 Output voltage
- ⑥ Optional \*1 \*8
- G :Low leakage current
- R :with Remote ON/OFF
- S :with Chassis
- SN :with Chassis & cover
- T :Vertical terminal block
- Y :with Potentiometer
- Z :with ZT

MODEL	LEB100F-0512	LEB100F-0324	LEB100F-0524	LEB100F-0530	LEB100F-0536
DC OUTPUT	V1	+5V 5A	+3.3V 5A	+5V 5A	+5V 5A
	V2	+12V 5(Peak 10)A	+24V 4(Peak 7)A	+24V 4(Peak 7)A	+30V 3.2(Peak 5.6)A

## SPECIFICATIONS

	MODEL	LEB100F-0512	LEB100F-0324	LEB100F-0524	LEB100F-0530	LEB100F-0536						
INPUT	VOLTAGE[V]	AC85 - 264 1 φ or DC 120 - 370										
	CURRENT[A]	ACIN 100V	1.2typ (Io=100%)	1.4typ (Io=100%)								
		ACIN 200V	0.6typ (Io=100%)	0.7typ (Io=100%)								
	FREQUENCY[Hz]	50/60 (47 - 63) or DC										
	EFFICIENCY[%]	ACIN 100V	74typ (Io=100%)	78typ (Io=100%)	78typ (Io=100%)	78typ (Io=100%)	78typ (Io=100%)					
		ACIN 200V	76typ (Io=100%)	80typ (Io=100%)	80typ (Io=100%)	80typ (Io=100%)	80typ (Io=100%)					
	POWER FACTOR	ACIN 100V	0.98typ	0.99typ								
		ACIN 200V	0.93typ									
	INRUSH CURRENT[A]	ACIN 100V	15typ (Io=100%) (At cold start) (Ta=25°C)									
		ACIN 200V	30typ (Io=100%) (At cold start) (Ta=25°C)									
LEAKAGE CURRENT[mA]	0.75max (60Hz, According to IEC60950 and DEN-AN)											
OUTPUT	VOLTAGE[V]	+5	+12	+3.3	+24	+5	+30	+5	+36			
	CURRENT[A]	*2 0 - 5	0 - 5 (Peak 10)	0 - 5	0 - 4 (Peak 7)	0 - 5	0 - 4 (Peak 7)	0 - 5	0 - 3.2 (Peak 5.6)	0 - 5	0 - 2.7 (Peak 4.7)	
	TOTAL OUTPUT WATTAGE[W]	*3 85 (Peak 145)		100 (Peak 172)		100 (Peak 172)		100 (Peak 172)		100 (Peak 172)		
	LINE REGULATION[mV]	20max	48max	20max	96max	20max	96max	20max	120max	20max	144max	
		40max	100max	40max	150max	40max	150max	40max	180max	40max	180max	
	LOAD REGULATION[mV]	80max	120max	80max	120max	80max	120max	80max	200max	80max	200max	
		140max	160max	140max	160max	140max	160max	140max	240max	140max	240max	
	RIPPLE[mVp-p]	0 to +50°C *4	80max	120max	80max	120max	80max	120max	80max	200max	80max	200max
		-10 - 0°C *4	140max	160max	140max	160max	140max	160max	140max	240max	140max	240max
	RIPPLE NOISE[mVp-p]	0 to +50°C *4	120max	150max	120max	150max	120max	150max	120max	300max	120max	300max
		-10 - 0°C *4	160max	180max	160max	180max	160max	180max	160max	360max	160max	360max
	TEMPERATURE REGULATION[mV]	0 to +50°C	50max	120max	50max	240max	50max	240max	50max	300max	50max	300max
		-10 to +50°C	60max	150max	60max	290max	60max	290max	60max	350max	60max	350max
	DRIFT[mV]	*5 20max	48max	20max	96max	20max	96max	20max	120max	20max	144max	
	START-UP TIME[ms]	*6 250max	500max	250max	500max	250max	500max	250max	500max	250max	500max	
	HOLD-UP TIME[ms]	*6 40typ	20typ	40typ	20typ	40typ	20typ	40typ	20typ	40typ	20typ	
	OUTPUT VOLTAGE ADJUSTMENT RANGE[V]	4.5 - 5.5	Fixed	2.85 - 3.60	Fixed	4.5 - 5.5	Fixed	4.5 - 5.5	Fixed	4.5 - 5.5	Fixed	
OUTPUT VOLTAGE SETTING[V]	—	11.5 - 12.5	—	23.0 - 25.0	—	23.0 - 25.0	—	28.7 - 31.5	—	34.5 - 37.5		
PROTECTION CIRCUIT AND OTHERS	OVERCURRENT PROTECTION	V1	Works over 105% of rating current and recovers automatically									
		V2	Works over 101% of peak current and recovers automatically									
	OVERVOLTAGE PROTECTION	V1	Works over 115% of rating, by zener diode clamping									
		V2	Works at 115 - 140% of rating									
REMOTE ON/OFF	Option (Refer to Instruction Manual)											
ISOLATION	INPUT-OUTPUT · RC	*7 AC3.000V 1minute, Cutoff current = 10mA, DC500V 50MΩ min (At Room Temperature)										
	INPUT-FG	AC2.000V 1minute, Cutoff current = 10mA, DC500V 50MΩ min (At Room Temperature)										
	OUTPUT · RC-FG	*7 AC500V 1minute, Cutoff current = 100mA, DC500V 50MΩ min (At Room Temperature)										
	OUTPUT-OUTPUT(V1 · RC-V2) *7	AC100V 1minute, Cutoff current = 100mA, DC100V 10MΩ min (At Room Temperature)										
ENVIRONMENT	OPERATING TEMP., HUMID. AND ALTITUDE	-10 to +70°C, 20 - 90%RH (Non condensing) (Refer to DERATING CURVE), 3,000m (10,000feet) max										
	STORAGE TEMP., HUMID. AND ALTITUDE	-20 to +75°C, 20 - 90%RH (Non condensing), 9,000m (30,000feet) max										
	VIBRATION	10 - 55Hz, 19.6m/s <sup>2</sup> (2G), 3minutes period, 60minutes each along X, Y and Z axis										
	IMPACT	196.1m/s <sup>2</sup> (20G), 11ms, once each X, Y and Z axis										
SAFETY AND NOISE REGULATIONS	AGENCY APPROVALS	UL60950-1, C-UL, EN60950-1, EN50178 Complies with DEN-AN and IEC60950-1 (At only AC input)										
	CONDUCTED NOISE	Complies with FCC-B, CISPR22-B, EN55022-B, VCCI-B										
	HARMONIC ATTENUATOR	Complies with IEC61000-3-2 *9										
OTHERS	CASE SIZE/WEIGHT	75 x 35 x 222mm [2.95 x 1.38 x 8.74 inches] /420g max (with chassis & cover : 690g max)										
	COOLING METHOD	Convection										

\*1 Specification is changed at option, refer to Instruction Manual 5.  
 \*2 Peak loading for 10sec. And Duty 35% max, refer to Instruction Manual 4. In detail.  
 \*3 Refer to Instruction Manual 2.2 in detail.  
 \*4 This is the value that measured on measuring board with capacitor of 22 μF within 150mm from output terminal. Measured by 20MHz oscilloscope or Ripple-Noise meter (Equivalent to KEISOKU-GIKEN: RM101).  
 \*5 Drift is the change in DC output for an eight hour period after a half-hour warm-up at 25°C, with the input voltage held constant at the rated input/output.

\*6 ACIN 100V, Io=100%  
 \*7 Applicable when remote control (optional) is added.  
 \*8 Please contact us about safety approvals for the model with option.  
 \*9 Please contact us about class C.  
 \* Series/Parallel operation is not possible.  
 \* Derating is required when operated with chassis and cover.  
 \* A sound may occur from power supply at peak loading.

## External view

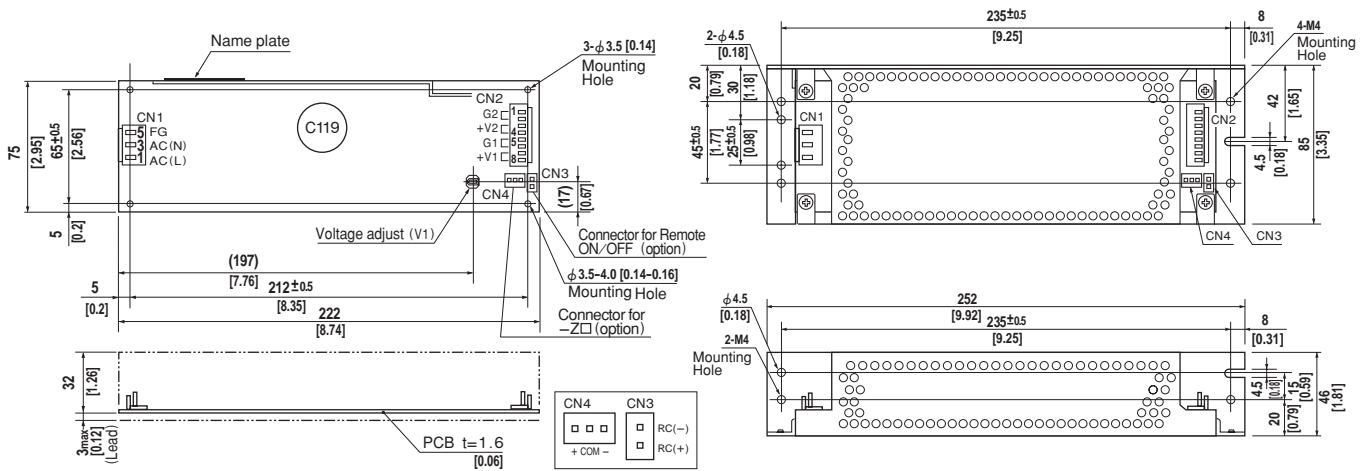

### (PIN CONNECTION)

I / O Connector	Mating Connector	Terminal
<b>CN1</b>	B3P5-VH	VHR-5N
<b>CN2</b>	B8P-VH	VHR-8N
<b>CN3 (Option)</b>	B2B-XH-A	XHP-2
<b>CN4 (Option)</b>	B3B-XH-A	XHP-3

CN1	
Pin No.	Input
1	AC(L)
2	
3	AC(N)
4	
5	FG

CN2	
Pin No.	Output
1, 2	G 2
3, 4	V 2
5, 6	G 1
7, 8	V 1

CN3 (Option)	
Pin No.	Remote ON/OFF
1	RC(+)
2	RC(-)

CN4 (Option)	
Pin No.	-Z□
1	+
2	COM
3	-

(Mfr: J.S.T.)

※Keep drawing current per pin below 5A for CN2

- ※Weight: 420g max  
(with chassis & cover : 690g max)
- ※Tolerance:  $\pm 1$  [ $\pm 0.04$ ]
- ※Dimensions in mm, [ ] = inches
- ※PCB Material : CEM3
- ※Chassis and cover is optional.
- ※Mounting torque: 1.5N·m(16kgf·cm)max

## Performance data

### RISE TIME & FALL TIME (LEB100F-0524)

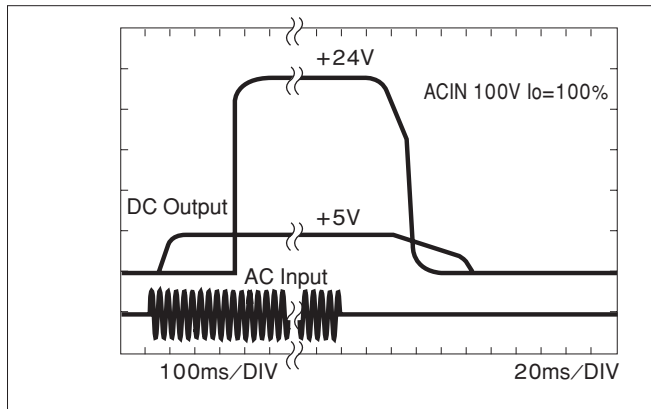

### EFFICIENCY (LEB100F-0524)

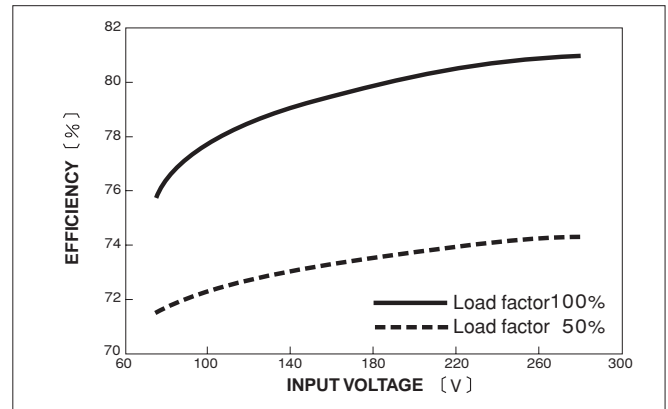

### INPUT HARMONIC CURRENT (LEB100F-0524)

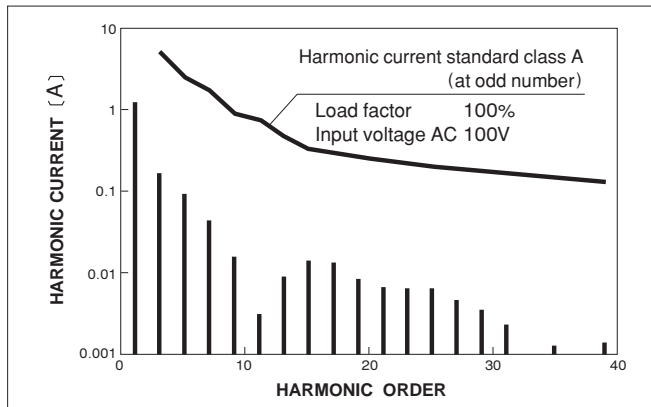

### INPUT HARMONIC CURRENT (LEB100F-0524)

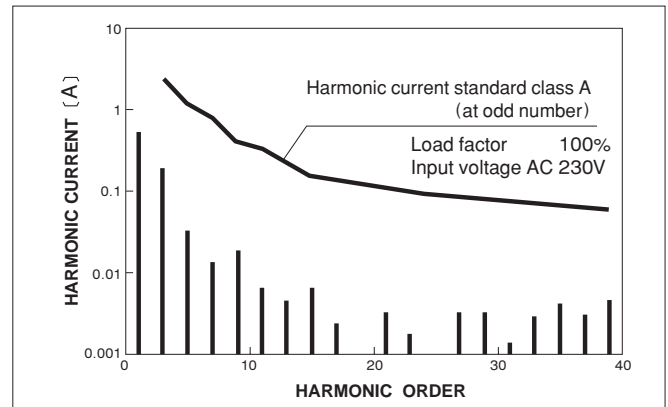

# LEB150F

LEB 150 F -05 24 -□

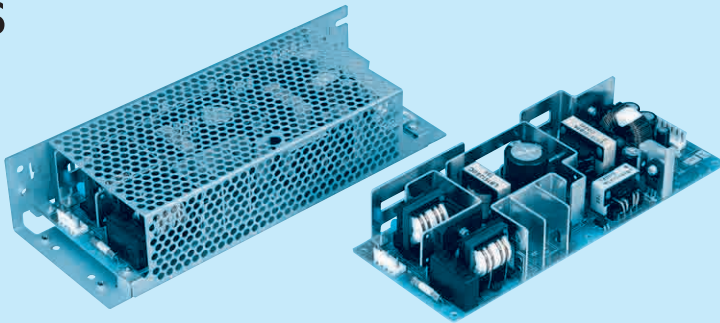

Recommended EMI/EMC Filter  
NAC-06-472



High voltage pulse noise type : NAP series  
Low leakage current type : NAM series  
\*The EMI/EMC Filter is recommended to connect with several devices.

- ① Series name
- ② Output wattage
- ③ Universal input
- ④ V1 Output voltage
- ⑤ V2 Output voltage
- ⑥ Optional \*1 \*8
- G : Low leakage current
- R : with Remote ON/OFF
- S : with Chassis
- SN : with Chassis & cover
- T : Vertical terminal block
- Y : with Potentiometer
- Z : with ZT

MODEL	LEB150F-0512	LEB150F-0324	LEB150F-0524	LEB150F-0530	LEB150F-0536
DC OUTPUT	V1	+5V 5A	+3.3V 5A	+5V 5A	+5V 5A
	V2	+12V 7.5(Peak 14)A	+24V 6(Peak 10)A	+24V 6(Peak 10)A	+30V 4.8(Peak 8)A

## SPECIFICATIONS

MODEL	LEB150F-0512	LEB150F-0324	LEB150F-0524	LEB150F-0530	LEB150F-0536							
INPUT	VOLTAGE[V]											
	AC85 - 264 1 φ or DC 120 - 370											
	CURRENT[A]	ACIN 100V	1.6typ (Io=100%)	2.0typ (Io=100%)								
		ACIN 200V	0.8typ (Io=100%)	1.0typ (Io=100%)								
	FREQUENCY[Hz]											
	50/60 (47 - 63) or DC											
	EFFICIENCY[%]	ACIN 100V	76typ (Io=100%)	79typ (Io=100%)	79typ (Io=100%)	79typ (Io=100%)						
	ACIN 200V	79typ (Io=100%)	82typ (Io=100%)	82typ (Io=100%)	82typ (Io=100%)							
POWER FACTOR	ACIN 100V	0.98typ	0.99typ									
	ACIN 200V	0.93typ										
INRUSH CURRENT[A]	ACIN 100V	15typ (Io=100%) (At cold start) (Ta=25°C)										
	ACIN 200V	30typ (Io=100%) (At cold start) (Ta=25°C)										
LEAKAGE CURRENT[mA]												
0.75max (60Hz, According to IEC60950 and DEN-AN)												
OUTPUT	VOLTAGE[V]	+5	+12	+3.3	+24	+5	+24	+5	+30	+5	+36	
	CURRENT[A]	*2 0 - 5	0 - 7.5 (Peak 14)	0 - 5	0 - 6 (Peak 10)	0 - 5	0 - 6 (Peak 10)	0 - 5	0 - 4.8 (Peak 8)	0 - 5	0 - 4 (Peak 6.7)	
	TOTAL OUTPUT WATTAGE[W]	*3 115 (Peak 193)		150 (Peak 246)		150 (Peak 246)		150 (Peak 246)		150 (Peak 246)		
	LINE REGULATION[mV]	20max	48max	20max	96max	20max	96max	20max	120max	20max	144max	
		40max	100max	40max	150max	40max	150max	40max	180max	40max	180max	
	LOAD REGULATION[mV]	80max	120max	80max	120max	80max	120max	80max	200max	80max	200max	
		140max	160max	140max	160max	140max	160max	140max	240max	140max	240max	
	RIPPLE[mVp-p]	0 to +45°C *4	80max	120max	80max	120max	80max	120max	80max	200max	80max	200max
		-10 - 0°C *4	140max	160max	140max	160max	140max	160max	140max	240max	140max	240max
	RIPPLE NOISE[mVp-p]	0 to +45°C *4	120max	150max	120max	150max	120max	150max	120max	300max	120max	300max
		-10 - 0°C *4	160max	180max	160max	180max	160max	180max	160max	360max	160max	360max
	TEMPERATURE REGULATION[mV]	0 to +45°C	50max	120max	50max	240max	50max	240max	50max	300max	50max	300max
		-10 to +45°C	60max	150max	60max	290max	60max	290max	60max	350max	60max	350max
	DRIFT[mV]	*5 20max	48max	20max	96max	20max	96max	20max	120max	20max	144max	
	START-UP TIME[ms]	*6 250max	500max	250max	500max	250max	500max	250max	500max	250max	500max	
	HOLD-UP TIME[ms]	*6 40typ	20typ	40typ	20typ	40typ	20typ	40typ	20typ	40typ	20typ	
	OUTPUT VOLTAGE ADJUSTMENT RANGE[V]	4.5 - 5.5		Fixed	2.85 - 3.60	Fixed	4.5 - 5.5	Fixed	4.5 - 5.5	Fixed	4.5 - 5.5	
OUTPUT VOLTAGE SETTING[V]	—		11.5 - 12.5	—	23.0 - 25.0	—	23.0 - 25.0	—	28.7 - 31.5	—	34.5 - 37.5	
PROTECTION CIRCUIT AND OTHERS	OVERCURRENT PROTECTION	V1	Works over 105% of rating current and recovers automatically									
		V2	Works over 101% of peak current and recovers automatically									
	OVERVOLTAGE PROTECTION	V1	Works over 115% of rating, by zener diode clamping									
		V2	Works at 115 - 140% of rating									
REMOTE ON/OFF												
Option (Refer to Instruction Manual)												
ISOLATION	INPUT-OUTPUT · RC	*7	AC3.000V 1minute, Cutoff current = 10mA, DC500V 50MΩ min (At Room Temperature)									
	INPUT-FG	AC2.000V 1minute, Cutoff current = 10mA, DC500V 50MΩ min (At Room Temperature)										
	OUTPUT · RC-FG	AC500V 1minute, Cutoff current = 100mA, DC500V 50MΩ min (At Room Temperature)										
	OUTPUT-OUTPUT(V1 · RC-V2) *7	AC100V 1minute, Cutoff current = 100mA, DC100V 10MΩ min (At Room Temperature)										
ENVIRONMENT	OPERATING TEMP.HUMID.AND ALTITUDE											
	-10 to +70°C, 20 - 90%RH (Non condensing) (Refer to DERATING CURVE), 3,000m (10,000feet) max											
	STORAGE TEMP.HUMID.AND ALTITUDE											
	-20 to +75°C, 20 - 90%RH (Non condensing), 9,000m (30,000feet) max											
SAFETY AND NOISE REGULATIONS	VIBRATION											
	10 - 55Hz, 19.6m/s <sup>2</sup> (2G), 3minutes period, 60minutes each along X, Y and Z axis											
	IMPACT											
196.1m/s <sup>2</sup> (20G), 11ms, once each X, Y and Z axis												
OTHERS	AGENCY APPROVALS											
	UL60950-1, C-UL, EN60950-1, EN50178 Complies with DEN-AN and IEC60950-1 (At only AC input)											
	CONDUCTED NOISE											
Complies with FCC-B, CISPR22-B, EN55022-B, VCCI-B												
HARMONIC ATTENUATOR												
Complies with IEC61000-3-2 *9												
CASE SIZE/WEIGHT												
85 x 40 x 222mm [3.35 x 1.57 x 8.74 inches] (W x H x D) /530g max (with chassis & cover : 870g max)												
COOLING METHOD												
Convection												

\*1 Specification is changed at option, refer to Instruction Manual 5.  
 \*2 Peak loading for 10sec. And Duty 35% max, refer to Instruction Manual 4. In detail.  
 \*3 Refer to Instruction Manual 2.2 in detail.  
 \*4 This is the value that measured on measuring board with capacitor of 22 μF within 150mm from output terminal. Measured by 20MHz oscilloscope or Ripple-Noise meter (Equivalent to KEISOKU-GIKEN: RM101).  
 \*5 Drift is the change in DC output for an eight hour period after a half-hour warm-up at 25°C, with the input voltage held constant at the rated input/output.

\*6 ACIN 100V, Io=100%  
 \*7 Applicable when remote control (optional) is added.  
 \*8 Please contact us about safety approvals for the model with option.  
 \*9 Please contact us about class C.  
 \* Series/Parallel operation is not possible.  
 \* Derating is required when operated with chassis and cover.  
 \* A sound may occur from power supply at peak loading.

## External view

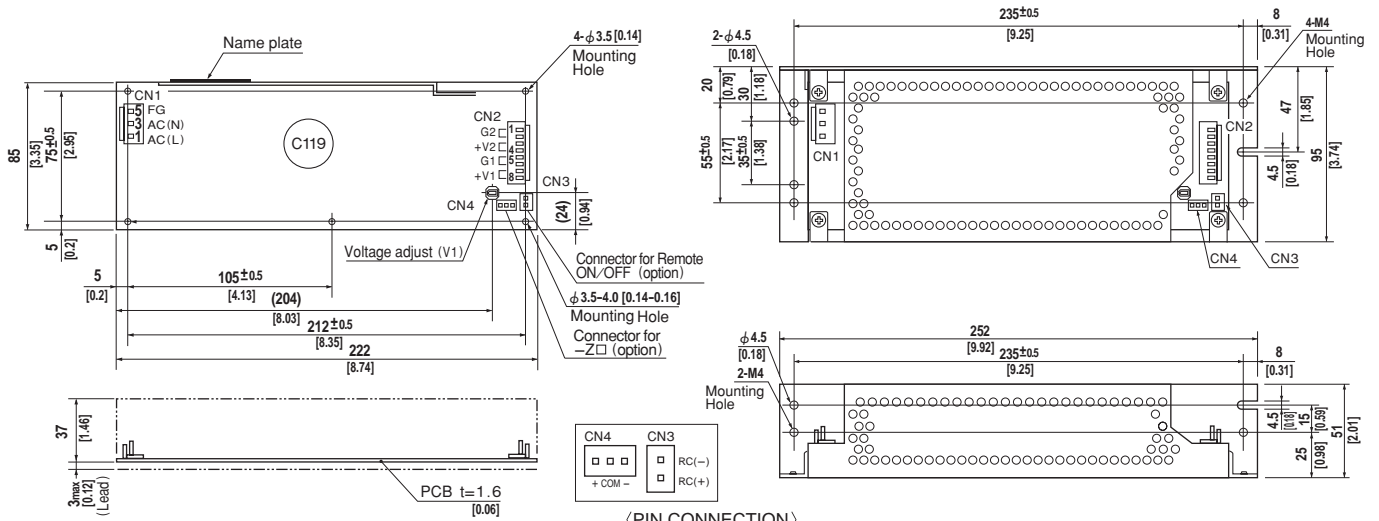

(PIN CONNECTION)

I / O Connector	Mating Connector	Terminal
<b>CN1</b>	B3P5-VH	VHR-5N
		Chain: SVH-21T-P1.1
		Loose: BVH-21T-P1.1
<b>CN2</b>	B8P-VH	VHR-8N
		Chain: SVH-21T-P1.1
		Loose: BVH-21T-P1.1
<b>CN3 (Option)</b>	B2B-XH-A	XHP-2
		Chain: SXH-001T-P0.6
		Loose: BXH-001T-P0.6
<b>CN4 (Option)</b>	B3B-XH-A	XHP-3
		Chain: SXH-001T-P0.6
		Loose: BXH-001T-P0.6

CN1		CN2	
Pin No.	Input	Pin No.	Output
1	AC(L)	1, 2	G 2
2		3, 4	V 2
3	AC(N)	5, 6	G 1
4		7, 8	V 1
5	FG		

CN3 (Option)	
Pin No.	Remote ON/OFF
1	RC(+)
2	RC(-)

CN4 (Option)	
Pin No.	-Z □
1	+
2	COM
3	-

※Weight: 530g max  
(with chassis & cover : 870g max)  
 ※Tolerance: ±1 [±0.04]  
 ※Dimensions in mm, [ ] = inches  
 ※PCB Material : CEM3  
 ※Chassis and cover is optional.  
 ※Mounting torque: 1.5N·m(16kgf·cm)max

(Mfr: J.S.T.)

※Keep drawing current per pin below 5A(7A at peak load)for CN2

## Performance data

### RISE TIME & FALL TIME (LEB150F-0524)

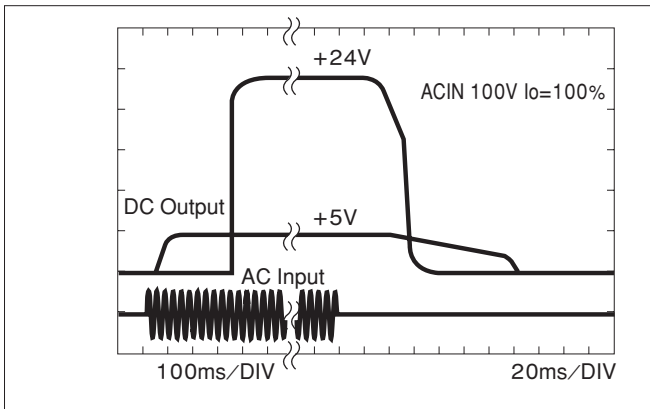

### EFFICIENCY (LEB150F-0524)

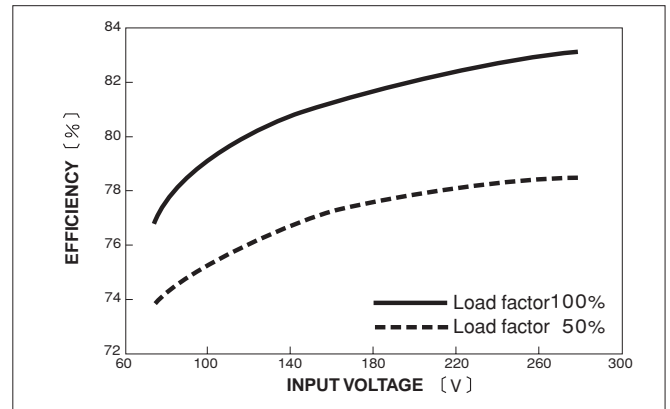

### INPUT HARMONIC CURRENT (LEB150F-0524)

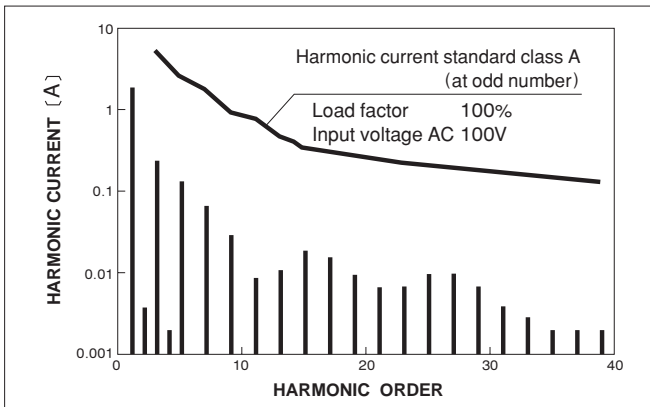

### INPUT HARMONIC CURRENT (LEB150F-0524)

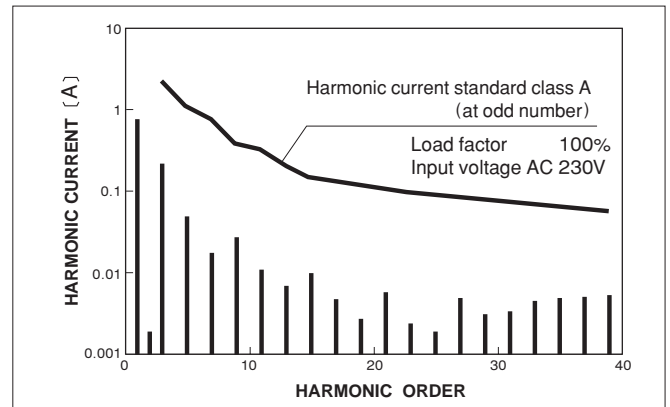

# LEB225F

LEB 225 F -05 24 -□

① ② ③ ④ ⑤ ⑥

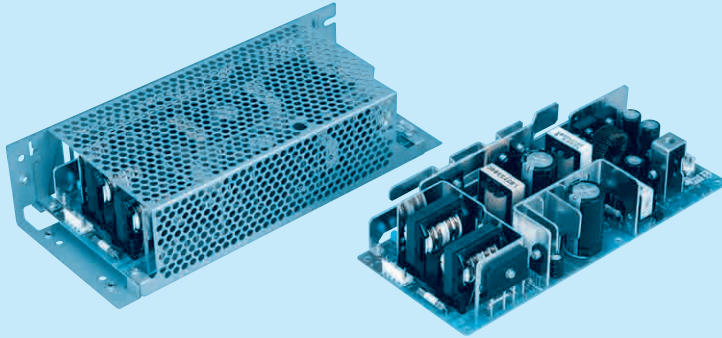

Recommended EMI/EMC Filter  
NAC-06-472



High voltage pulse noise type : NAP series  
Low leakage current type : NAM series  
\*The EMI/EMC Filter is recommended to connect with several devices.

- ① Series name
- ② Output wattage
- ③ Universal input
- ④ V1 Output voltage
- ⑤ V2 Output voltage
- ⑥ Optional \*1 \*8
- G :Low leakage current
- R :with Remote ON/OFF
- S :with Chassis
- SN :with Chassis & cover
- T :Vertical terminal block
- Y :with Potentiometer
- Z :with ZT

MODEL	LEB225F-0512	LEB225F-0324	LEB225F-0524	LEB225F-0530	LEB225F-0536
DC OUTPUT	V1	+5V 5A	+3.3V 5A	+5V 5A	+5V 5A
	V2	+12V 10(Peak 20)A	+24V 9(Peak 14)A	+24V 9(Peak 14)A	+30V 7.2(Peak 11)A

## SPECIFICATIONS

	MODEL	LEB225F-0512	★LEB225F-0324	LEB225F-0524	LEB225F-0530	★LEB225F-0536						
INPUT	VOLTAGE[V]	AC85 - 264 1 φ or DC 120 - 370										
	CURRENT[A]	ACIN 100V	1.9typ (Io=100%)	3.0typ (Io=100%)								
		ACIN 200V	1.0typ (Io=100%)	1.5typ (Io=100%)								
	FREQUENCY[Hz]	50/60 (47 - 63) or DC										
	EFFICIENCY[%]	ACIN 100V	77typ (Io=100%)	81typ (Io=100%)	81typ (Io=100%)	81typ (Io=100%)	81typ (Io=100%)					
		ACIN 200V	79typ (Io=100%)	83typ (Io=100%)	83typ (Io=100%)	83typ (Io=100%)	83typ (Io=100%)					
	POWER FACTOR	ACIN 100V	0.98typ	0.99typ								
		ACIN 200V	0.93typ									
INRUSH CURRENT[A]	ACIN 100V	15typ (Io=100%) (More than 3sec.to re-start)										
	ACIN 200V	30typ (Io=100%) (More than 3sec.to re-start)										
LEAKAGE CURRENT[mA]	0.75max (60Hz, According to IEC60950 and DEN-AN)											
OUTPUT	VOLTAGE[V]	+5	+12	+3.3	+24	+5	+30	+5	+36			
	CURRENT[A]	*2 0 - 5	0 - 10 (Peak 20)	0 - 5	0 - 9 (Peak 14)	0 - 5	0 - 9 (Peak 14)	0 - 5	0 - 7.2 (Peak 11)	0 - 5	0 - 6 (Peak 9.3)	
	TOTAL OUTPUT WATTAGE[W]	*3 145 (Peak 265)										
	LINE REGULATION[mV]	20max	48max	20max	96max	20max	96max	20max	120max	20max	144max	
		40max	100max	40max	150max	40max	150max	40max	180max	40max	180max	
	LOAD REGULATION[mV]	80max	120max	80max	120max	80max	120max	80max	200max	80max	200max	
		-10 - 0°C *4	140max	160max	140max	160max	140max	160max	140max	240max	140max	240max
	RIPPLE[mVp-p]	0 to +40°C *4	80max	120max	80max	120max	80max	120max	80max	200max	80max	200max
		-10 - 0°C *4	120max	150max	120max	150max	120max	150max	120max	300max	120max	300max
	RIPPLE NOISE[mVp-p]	0 to +40°C *4	160max	180max	160max	180max	160max	180max	160max	360max	160max	360max
		-10 - 0°C *4	120max	150max	120max	150max	120max	150max	120max	300max	120max	300max
	TEMPERATURE REGULATION[mV]	0 to +40°C	50max	120max	50max	240max	50max	240max	50max	300max	50max	300max
		-10 to +40°C	60max	150max	60max	290max	60max	290max	60max	350max	60max	350max
	DRIFT[mV]	*5	20max	48max	20max	96max	20max	96max	20max	120max	20max	144max
	START-UP TIME[ms]	*6	250max	500max	250max	500max	250max	500max	250max	500max	250max	500max
	HOLD-UP TIME[ms]	*6	40typ	20typ	40typ	20typ	40typ	20typ	40typ	20typ	40typ	20typ
	OUTPUT VOLTAGE ADJUSTMENT RANGE[V]		4.5 - 5.5	Fixed	2.85 - 3.60	Fixed	4.5 - 5.5	Fixed	4.5 - 5.5	Fixed	4.5 - 5.5	Fixed
OUTPUT VOLTAGE SETTING[V]		—	11.5 - 12.5	—	23.0 - 25.0	—	23.0 - 25.0	—	28.7 - 31.5	—	34.5 - 37.5	
PROTECTION CIRCUIT AND OTHERS	OVERCURRENT PROTECTION	V1	Works over 105% of rating current and recovers automatically									
		V2	Works over 101% of peak current and recovers automatically									
	OVERVOLTAGE PROTECTION	V1	Works over 115% of rating, by zener diode clamping									
		V2	Works at 115 - 140% of rating									
REMOTE ON/OFF	Option (Refer to Instruction Manual)											
ISOLATION	INPUT-OUTPUT · RC	*7	AC3.000V 1minute, Cutoff current = 10mA, DC500V 50MΩ min (At Room Temperature)									
	INPUT-FG	AC2.000V 1minute, Cutoff current = 10mA, DC500V 50MΩ min (At Room Temperature)										
	OUTPUT · RC-FG	*7	AC500V 1minute, Cutoff current = 100mA, DC500V 50MΩ min (At Room Temperature)									
	OUTPUT-OUTPUT(V1 · RC-V2) *7	*7	AC100V 1minute, Cutoff current = 100mA, DC100V 10MΩ min (At Room Temperature)									
ENVIRONMENT	OPERATING TEMP., HUMID. AND ALTITUDE	-10 to +70°C, 20 - 90%RH (Non condensing) (Refer to DERATING CURVE), 3,000m (10,000feet) max										
	STORAGE TEMP., HUMID. AND ALTITUDE	-20 to +75°C, 20 - 90%RH (Non condensing), 9,000m (30,000feet) max										
	VIBRATION	10 - 55Hz, 19.6m/s <sup>2</sup> (2G), 3minutes period, 60minutes each along X, Y and Z axis										
SAFETY AND NOISE REGULATIONS	IMPACT	196.1m/s <sup>2</sup> (20G), 11ms, once each X, Y and Z axis										
	AGENCY APPROVALS	UL60950-1, C-UL, EN60950-1, EN50178 Complies with DEN-AN and IEC60950-1 (At only AC input)										
	CONDUCTED NOISE	Complies with FCC-B, CISPR22-B, EN55022-B, VCCI-B										
OTHERS	HARMONIC ATTENUATOR	Complies with IEC61000-3-2 *9										
	CASE SIZE/WEIGHT	95 x 45 x 222mm [3.74 x 1.77 x 8.74 inches] /700g max (with chassis & cover : 1,080g max)										
	COOLING METHOD	Convection										

\*1 Specification is changed at option, refer to Instruction Manual 5.  
 \*2 Peak loading for 10sec. And Duty 35% max, refer to Instruction Manual 4. In detail.  
 \*3 Refer to Instruction Manual 2.2 in detail.  
 \*4 This is the value that measured on measuring board with capacitor of 22 μF within 150mm from output terminal. Measured by 20MHz oscilloscope or Ripple-Noise meter (Equivalent to KEISOKU-GIKEN: RM101).  
 \*5 Drift is the change in DC output for an eight hour period after a half-hour warm-up at 25°C, with the input voltage held constant at the rated input/output.

\*6 ACIN 100V, Io=100%  
 \*7 Applicable when remote control (optional) is added.  
 \*8 Please contact us about safety approvals for the model with option.  
 \*9 Please contact us about class C.  
 \* Series/Parallel operation is not possible.  
 \* Derating is required when operated with chassis and cover.  
 \* A sound may occur from power supply at peak loading.  
 \*marked models are pending for safety approvals. Consult with us for delivery.

## External view

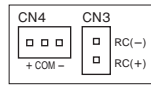
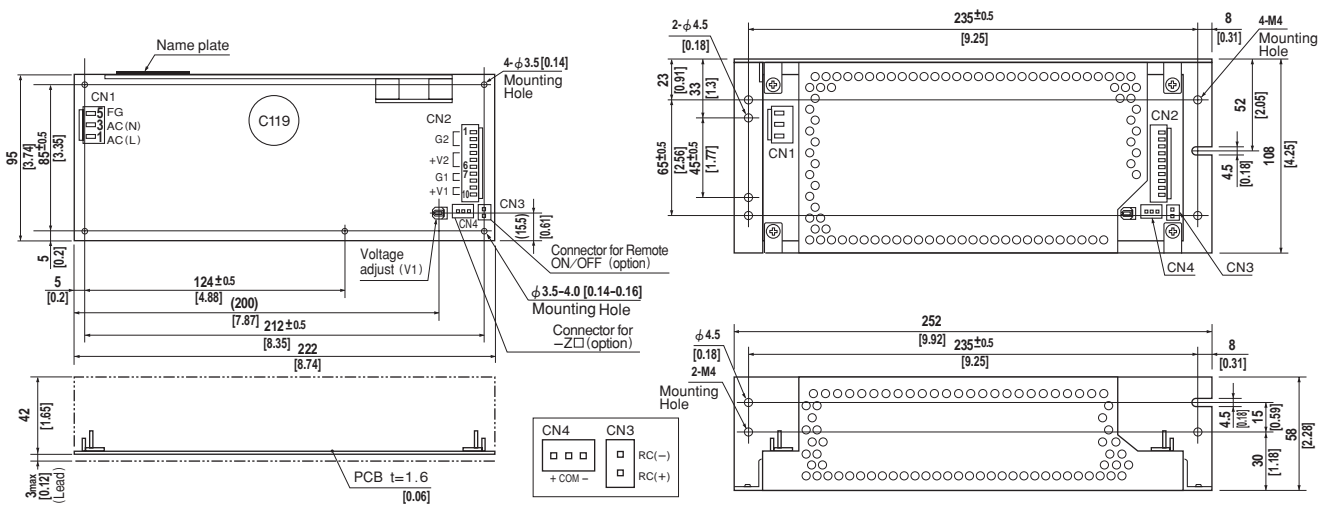

### (PIN CONNECTION)

I / O Connector	Mating Connector	Terminal
<b>CN1</b>	B3P5-VH	VHR-5N
		Chain: SVH-21T-P1.1
		Loose: BVH-21T-P1.1
<b>CN2</b>	B10P-VH	VHR-10N
		Chain: SVH-21T-P1.1
		Loose: BVH-21T-P1.1
<b>CN3 (Option)</b>	B2B-XH-A	XHP-2
		Chain: SXH-001T-P0.6
		Loose: BXH-001T-P0.6
<b>CN4 (Option)</b>	B3B-XH-A	XHP-3
		Chain: SXH-001T-P0.6
		Loose: BXH-001T-P0.6

CN1	
Pin No.	Input
1	AC(L)
2	
3	AC(N)
4	
5	FG

CN2	
Pin No.	Output
1, 2, 3	G 2
4, 5, 6	V 2
7, 8	G 1
9, 10	V 1

CN3 (Option)	
Pin No.	Remote ON/OFF
1	RC(+)
2	RC(-)

CN4 (Option)	
Pin No.	-Z□
1	+
2	COM
3	-

- ※Weight: 700g max (with chassis & cover : 1,080g max)
- ※Tolerance: ±1 [±0.04]
- ※Dimensions in mm, [ ] = inches
- ※PCB Material : CEM3
- ※Chassis and cover is optional.
- ※Mounting torque: 1.5N · m(16kgf · cm)max

(Mfr: J.S.T.) ※Keep drawing current per pin below 5A (7A at peak load) for CN2

## Performance data

### RISE TIME & FALL TIME (LEB225F-0524)

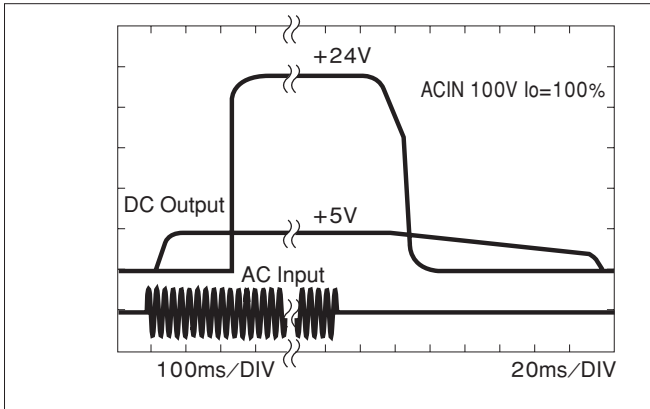

### EFFICIENCY (LEB225F-0524)

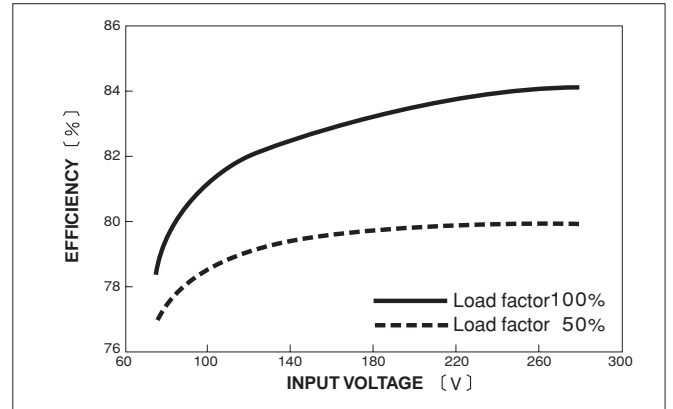

### INPUT HARMONIC CURRENT (LEB225F-0524)

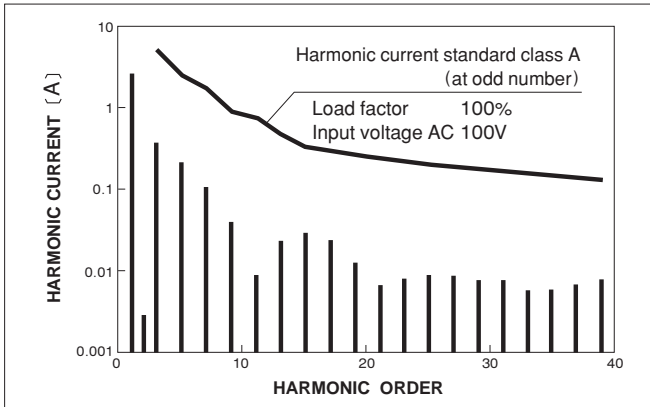

### INPUT HARMONIC CURRENT (LEB225F-0524)

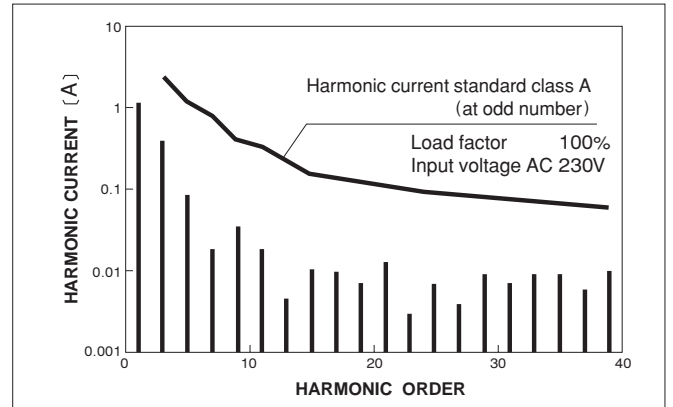

# Mouser Electronics

Authorized Distributor

Click to View Pricing, Inventory, Delivery & Lifecycle Information:

## Cosel:

[LEB100F-0512-SNT](#) [LEB100F-0524-Z32](#) [LEB100F-0524-Z34](#) [LEB150F-0524-RY](#) [LEB225F-0524-SN](#) [LEB225F-0524-SNY](#) [LEB225F-0524-RY](#) [LEB225F-0536-SN](#) [LEB225F-0324-SN](#) [LEB225F-0324-SNT](#) [LEB225F-0324-T](#) [LEB225F-0512-TY](#) [LEB225F-0524](#) [LEB150F-0536](#) [LEB225F-0324](#) [LEB225F-0524-S](#) [LEB225F-0524-SNR](#) [LEB225F-0524-T](#) [LEB225F-0530](#) [LEB150F-0512-S](#) [LEB150F-0524-SN](#) [LEB150F-0524-SNY](#) [LEB150F-0524-SNZ31](#) [LEB150F-0524-SNZ35](#) [LEB150F-0524-U](#) [LEB100F-0524-RY](#) [LEB100F-0524-SNY](#) [LEB100F-0524-SZ32](#) [LEB100F-0524-SZ35](#) [LEB100F-0524-T](#) [LEB100F-0536-SNT](#) [LEB100F-0512-C](#) [LEB100F-0512-SNRT](#) [LEB100F-0512-SNZ25](#) [LEB100F-0512-SZ22](#) [LEB100F-0512-Z21](#) [LEB100F-0524-GR](#) [LEB100F-0524-SNZ32](#) [LEB100F-0524-SR](#) [LEB100F-0536-RY](#) [LEB100F-0536-SN](#) [LEB100F-0536-Y](#) [LEB100F-0512](#) [LEB100F-0512-SZ23](#) [LEB100F-0512-SZ25](#) [LEB100F-0512-Y](#) [LEB100F-0524-G](#) [LEB100F-0524-RT](#) [LEB100F-0524-SN](#) [LEB225F-0536-R](#) [LEB100F-0324-T](#) [LEB100F-0324-Y](#) [LEB100F-0512-GR](#) [LEB100F-0512-SNY](#) [LEB100F-0512-SZ21](#) [LEB225F-0524-SNC](#) [LEB225F-0524-SNGT](#) [LEB225F-0524-SNT](#) [LEB225F-0524-SNZ35](#) [LEB225F-0530-S](#) [LEB225F-0536](#) [LEB225F-0512-SNZ25](#) [LEB225F-0512-Y](#) [LEB225F-0524-CR](#) [LEB225F-0524-CY](#) [LEB225F-0524-G](#) [LEB225F-0524-R](#) [LEB150F-0524-Y](#) [LEB150F-0524-Z34](#) [LEB150F-0530](#) [LEB150F-0536-SN](#) [LEB225F-0512-SN](#) [LEB225F-0512-SNR](#) [LEB150F-0512-SNT](#) [LEB150F-0512-Z25](#) [LEB150F-0524-S](#) [LEB150F-0524-SNRT](#) [LEB150F-0524-SNT](#) [LEB150F-0524-TY](#) [LEB225F-0524-SZ35](#) [LEB225F-0524-TY](#) [LEB225F-0524-U](#) [LEB225F-0524-Y](#) [LEB150F-0512-G](#) [LEB150F-0512-R](#) [LEB100F-0530-Y](#) [LEB100F-0536-C](#) [LEB100F-0536-R](#) [LEB225F-0524-CRY](#) [LEB225F-0524-GY](#) [LEB225F-0524-SNG](#) [LEB100F-0524-ST](#) [LEB100F-0524-SZ31](#) [LEB100F-0524-SZ34](#) [LEB100F-0524-U](#) [LEB100F-0524-Y](#) [LEB100F-0524-Z35](#) [LEB100F-0524-CT](#) [LEB100F-0524-GT](#) [LEB100F-0524-R](#)

Компания «Life Electronics» занимается поставками электронных компонентов импортного и отечественного производства от производителей и со складов крупных дистрибьюторов Европы, Америки и Азии.

С конца 2013 года компания активно расширяет линейку поставок компонентов по направлению коаксиальный кабель, кварцевые генераторы и конденсаторы (керамические, пленочные, электролитические), за счёт заключения дистрибьюторских договоров

Мы предлагаем:

- Конкуренспособные цены и скидки постоянным клиентам.
- Специальные условия для постоянных клиентов.
- Подбор аналогов.
- Поставку компонентов в любых объемах, удовлетворяющих вашим потребностям.
- Приемлемые сроки поставки, возможна ускоренная поставка.
- Доставку товара в любую точку России и стран СНГ.
- Комплексную поставку.
- Работу по проектам и поставку образцов.
- Формирование склада под заказчика.
- Сертификаты соответствия на поставляемую продукцию (по желанию клиента).
- Тестирование поставляемой продукции.
- Поставку компонентов, требующих военную и космическую приемку.
- Входной контроль качества.
- Наличие сертификата ISO.

В составе нашей компании организован Конструкторский отдел, призванный помогать разработчикам, и инженерам.

Конструкторский отдел помогает осуществить:

- Регистрацию проекта у производителя компонентов.
- Техническую поддержку проекта.
- Защиту от снятия компонента с производства.
- Оценку стоимости проекта по компонентам.
- Изготовление тестовой платы монтаж и пусконаладочные работы.



Тел: +7 (812) 336 43 04 (многоканальный)

Email: [org@lifeelectronics.ru](mailto:org@lifeelectronics.ru)