

# Solid-state Timers H3DT

## DIN 17.5-mm-wide Slim Timers with Push-in Plus Terminal Blocks for In-panel Applications

- Saves space and reduces work in control panels.
- Slim Timers (17.5-mm width) with two sets of contacts: One of the slimmest Timers worldwide. \*1
- Reduces power consumption (active power) by up to 60% to help reduce heat generation in control panels. \*2
- Certified for maritime standards (LR/DNV GL). \*3

\*1. According to OMRON investigation in October 2015.  
 \*2. Based on OMRON comparison (excluding the H3DT-H).  
 \*3. Certification is pending for DNV GL.



\* CSA conformance evaluation by UL.



For the most recent information on models that have been certified for safety standards, refer to your OMRON website.

## Model Number Structure

### The Entire H3DT Series



## Model Number Legend

H3DT-□□□□  
1 2 3 4

### 1. Type

Symbol	Meaning
N	Standard Eight-mode Timer
L	Expansion Eight-mode Timer
A	Power ON-delay Timer
F	Twin Timer
G	Star-delta Timer
H	Power OFF-delay Timer

### 2. Control Output \*

Symbol	Meaning
1	SPDT
2	DPDT

\* N-, L- and A-type models only.

### 3. Supply Voltage

Symbol	Meaning
Blank	24 to 240 VAC/DC
B *	24 to 48 VAC/DC
C *	100 to 120 VAC
D *	200 to 240 VAC

\* H-type models only.

### 4. Time Ranges \*

Symbol	Meaning
S	0.1 to 1.2 s or 1 to 12 s
L	1 to 12 s or 10 to 120 s

\* H-type models only.

# Multi-range, Multi-mode Timer H3DT-N/H3DT-L

- Multiple time ranges and operating modes for a wide range of applications.
- The time-limit DPDT output contacts can be changed to time-limit SPDT and instantaneous SPDT output contacts using a switch.
- Sequence checks are easily performed by setting an instantaneous output to 0.
- Start signal control for some operating modes.



\* CSA conformance evaluation by UL.



For the most recent information on models that have been certified for safety standards, refer to your OMRON website.

## Ordering Information

### List of Models

Supply voltage		Control output		H3DT-N/H3DT-L	
				Standard Eight-mode Timer	Expansion Eight-mode Timer
24 to 240 VAC/DC	Contact output, DPDT (time-limit DPDT, or time-limit SPDT + instantaneous SPDT) Changed using a switch.	Model	H3DT-N2	H3DT-L2	
	Contact output, SPDT (time-limit SPDT)		H3DT-N1	H3DT-L1	

### Model Structure

Model	Operating modes	Terminal block	Input type	Output type	Mounting method	Safety standards
H3DT-N2	A2: ON Delay (Power ON Delay) B3: Flicker OFF Start (Power ON Start) B4: Flicker ON Start (Power ON Start) D: Signal OFF Delay	10 terminals	Voltage input	Relay, DPDT	DIN Track mounting	cULus (UL 508 CSA C22.2 No.14) CCC LR DNV GL * EN 61812-1 IEC 60664-1 4 kV/2
H3DT-N1	E2: Interval (Power ON Start) E3: Signal OFF Interval F2: Cumulative (ON Delay) F3: Cumulative (Interval)	8 terminals		Relay, SPDT		
H3DT-L2	A: ON Delay (Signal ON Delay) B: Flicker OFF Start (Signal Start) B2: Flicker ON Start (Signal Start) C: Signal ON/OFF Delay	10 terminals		Relay, DPDT		
H3DT-L1	E: Interval (Signal Start) G: Signal ON/OFF Delay J: One-shot Output (Signal Start) J2: One-shot Output (Power ON Start)	8 terminals		Relay, SPDT		

\* Certification is pending for DNV GL.

## Specifications

### Time Ranges

Time range setting	0.1 s	1 s	10 s	1 min	10 min	1 h	10 h	100 h
Set time range	0.1 to 1.2 s	1 to 12 s	10 to 120 s	1 to 12 min	10 to 120 min	1 to 12 h	10 to 120 h	100 to 1,200 h
Scale numbers	12							

### Ratings

<b>Power supply voltage #1</b>		24 to 240 VAC/DC, 50/60 Hz #2
<b>Allowable voltage fluctuation range</b>		85% to 110% of rated voltage
<b>Power reset</b>		Minimum power-OFF time: 0.1 s
<b>Reset voltage</b>		10% of rated voltage
<b>Voltage input</b>		24 to 240 VAC/DC High level: 20.4 to 264 VAC/DC, Low level: 0 to 2.4 VAC/DC
<b>*3 Power consumption</b>	<b>H3DT-N2/-L2</b>	At 240 VAC: 2.3 VA max., at 240 VDC: 1.0 W max., at 24 VDC: 0.3 W max.
	<b>H3DT-N1/-L1</b>	At 240 VAC: 2.0 VA max., at 240 VDC: 0.9 W max., at 24 VDC: 0.3 W max.
<b>Rated Insulation Voltage</b>		250 VAC
<b>Control output</b>		Contact output: 5 A at 250 VAC with resistive load ( $\cos\phi = 1$ ), 5 A at 30 VDC with resistive load #5, 0.15 A max. at 125 VDC with resistive load, 0.1A max. at 125 VDC with L/R of 7 ms. The minimum applicable load is 10 mA at 5 VDC (P reference value). Contact materials : Ag-alloy + Gold plating (Recommended fuse: BLN5 (Littelfuse) or 0216005MXEP)
<b>Ambient operating temperature</b>		-20 to 60°C (with no icing)
<b>Storage temperature</b>		-40 to 70°C (with no icing)
<b>Surrounding air operating humidity</b>		25% to 85%

**\*1.** When using a 24-VDC power supply voltage, there will be an inrush current of approximately 0.5 A. Allow for this inrush current when turning ON and OFF the power supply to the Timer with device with a solid-state output, such as a sensor.

**\*2.** DC ripple: 20% max.

**\*3.** The power consumption is for after the Timer times out in mode F2 for the H3DT-N and mode A for the H3DT-L.  
The maximum power consumption is given, including the current consumed by the input circuit.

## Characteristics

Accuracy of operating time	±1% of FS max. (±1% ±10 ms max. at 1.2-s range)
Setting error	±10% of FS ±0.05 s max.
Minimum input signal width	50 ms (start input)
Influence of voltage	±0.5% of FS max. (±0.5% ±10 ms max. at 1.2-s range)
Influence of temperature	±2% of FS max. (±2% ±10 ms max. at 1.2-s range)
Insulation resistance	100 MΩ min. at 500 VDC
Dielectric strength	Between charged metal part and operating section: 2,900 VAC 50/60 Hz for 1 min.
	Between control output terminals and operating circuit: 2,000 VAC 50/60 Hz for 1 min.
	Between contacts not located next to each other: 1,000 VAC 50/60 Hz for 1 min.
Impulse withstand test voltage	5 kV between power terminals, 7.4 kV between conductor terminal and operating section
Noise immunity	Square-wave noise generated by noise simulator (pulse width: 100 ns/1 μs, 1-ns rise): ±1.5 kV
Static immunity	Malfunction: 4 kV, Destruction: 8 kV
Vibration resistance	<b>Destruction</b> 0.75-mm single amplitude at 10 to 55 Hz for 2 h each in 3 directions
	<b>Malfunction</b> 0.5-mm single amplitude at 10 to 55 Hz for 10 min each in 3 directions
Shock resistance	<b>Destruction</b> 1,000 m/s <sup>2</sup> 3 times each in 6 directions
	<b>Malfunction</b> 100 m/s <sup>2</sup> 3 times each in 6 directions
Life expectancy	<b>Mechanical</b> 10 million operations min. (under no load at 1,800 operations/h)
	<b>Electrical</b> 100,000 operations min. (5 A at 250 VAC, resistive load at 360 operations/h)
Degree of protection	IP30 (Terminal block: IP20)
Weight	Approx. 100 g

## Applicable standards

Safety standards	cULus: UL 508/CSA C22.2 No. 14 EN 61812-1: Pollution degree 2, Overvoltage category III CCC: Pollution degree 2, Overvoltage category II, section GB 14048.5 LR: Category ENV1.2 DNV GL *
	EMC
EMC	(EMI) EN 61812-1
	Radiated Emissions: EN 55011 class B
	Emission AC Mains: EN 55011 class B
	Harmonic Current: EN 61000-3-2
	Voltage Fluctuations and Flicker: EN 61000-3-3
	(EMS) EN 61812-1
	Immunity ESD: EN 61000-4-2
	Immunity RF-interference: EN 61000-4-3
	Immunity Burst: EN 61000-4-4
	Immunity Surge: EN 61000-4-5
Immunity Conducted Disturbance: EN 61000-4-6	
Immunity Voltage Dip/Interruption: EN 61000-4-11	

\* Certification is pending for DNV GL.

## I/O

Item	Model	H3DT-N/L
Input	Start	Functions to start timing.
Output	Control output	The output is turned ON/OFF according to the operating mode when the value that is set on the dial is reached. *

\* If the INST/TIME switch on the front of the Timer is set to INST, relay R2 will operate as instantaneous contacts and will turn ON/OFF in synchronization with the power supply.

## Relation between H3DT Ambient Temperature and Mounting Interval (Reference Values)

The relation between the ambient temperature and mounting interval is shown in the following graph.

If the Timer is used at 55°C or higher with a mounting interval that is smaller than that shown in the following diagram, the temperature inside the Timer will increase, reducing the life expectancy of internal parts.

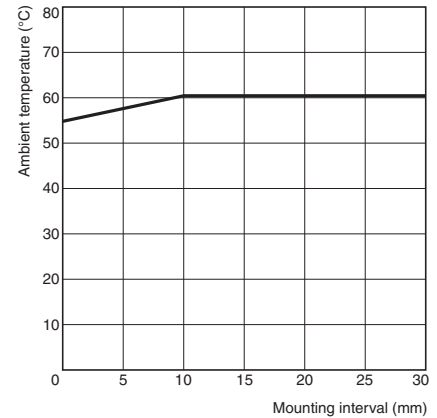

### Testing Method

Tested Timer: H3DT-N/L  
Applied voltage: 240 VAC  
Installation pitch: 0 and 10 mm  
Load current: 5 A

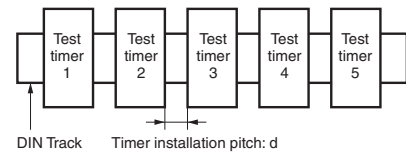

# Connections

## Block Diagrams

H3DT-N/L

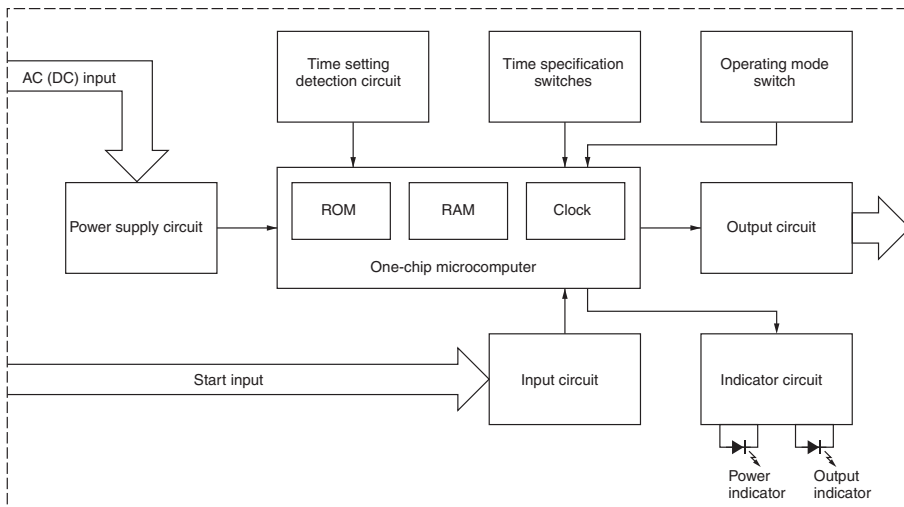

## Terminal Arrangement



\*1. The relay R2 can be set to either instantaneous or time-limit contacts using the switch on the front of the Timer.

\*2. The power supply terminals do not have polarity.

(DIN notation)

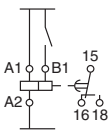

(DIN notation)

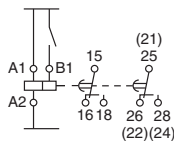

# H3DT-N/H3DT-L

## Input Connections

The start input is a voltage input.

### PNP Transistor Input

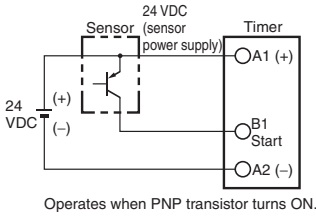

Operates when PNP transistor turns ON.

### NPN Transistor Input

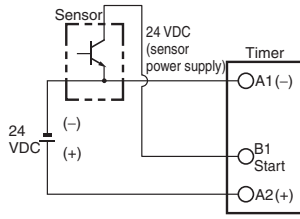

Operates when NPN transistor turns ON.

### Relay Input

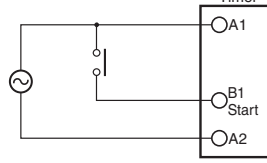

Operates when relay turns ON.

Consider the minimum load of the relay. (See signal levels on the right.)

### Voltage Input Signal Levels

<b>Transistor input</b>	1. Transistor ON • Residual voltage: 1 V max. Voltage between terminals B1 and A2 must be equal to or higher than the rated high level voltage (20.4 VDC min.).
	2. Transistor OFF • Leakage current: 0.01 mA max. Voltage between terminals B1 and A2 must be equal to or below the rated low level voltage (2.4 VDC min.).
<b>Relay input</b>	Use relays that can adequately switch 0.1 mA at the imposed voltage. When the relay is ON or OFF, the voltage between terminals B1 and A2 must be within the following ranges: • 24 to 240 VAC/DC When relay is ON: 20.4 to 264 VAC/DC When relay is OFF: 0 to 2.4 V • 12 VDC When relay is ON: 10.8 to 13.2 V When relay is OFF: 0 to 1.2 V

## Nomenclature

### H3DT-N2/L2



### H3DT-N1/L1

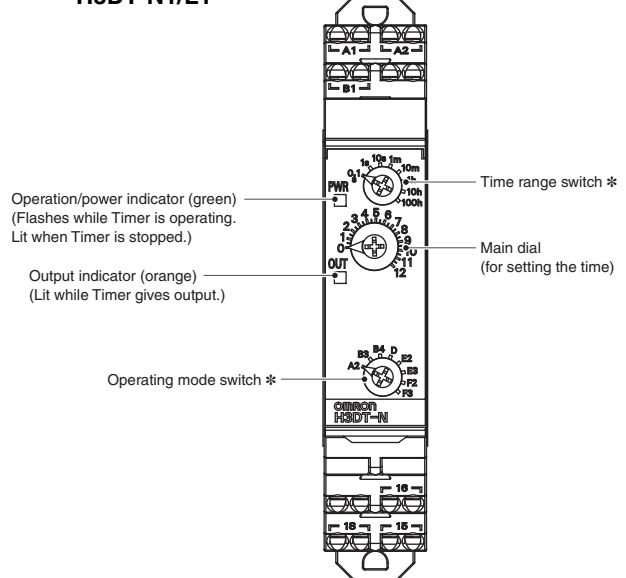

\* If the switch is left between settings, proper operation may not be possible.  
Make sure that the switch is set properly.  
Note: The default settings are for 0.1 s in mode A2 for the H3DT-N and mode A for the H3DT-L.

\* If the switch is left between settings, proper operation may not be possible.  
Make sure that the switch is set properly.  
Note: The default settings are for 0.1 s in mode A2 for the H3DT-N and mode A for the H3DT-L.

# Dimensions

## Timers

H3DT-N  
H3DT-L



H3DT-N2  
H3DT-L2

H3DT-N1  
H3DT-L1



H3DT-N2  
H3DT-L2

H3DT-N1  
H3DT-L1

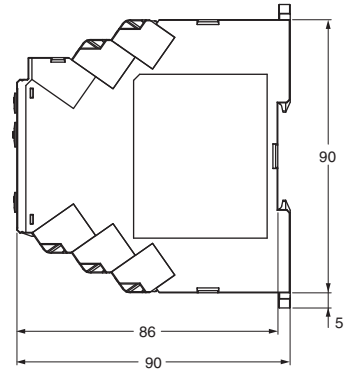
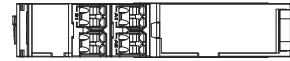

## Track Mounting Products (Sold Separately)

Refer to page 29 for details.

## Options (Order Separately)

### Front Cover

Refer to page 29 for details.

## Operating Procedures

### Basic Operation

#### Setting Switches

- Each switch has a snap mechanism that secures the switch at given positions. Set the switch to one of these positions. Do not set it midway between two positions. Malfunction could result from an improper setting.

#### Setting the Operating Mode

##### Setting the Operating Mode

The H3DT-N/L can be set to any of eight operating modes. Turn the operating mode switch with a flat-blade or Phillips screwdriver.



#### Setting the INIT/TIME Switch

##### Switching Relay R2 between Instantaneous and Time-limit Contacts (H3DT-N2/L2 Only)

The INIT/TIME switch can be used to switch relay R2 between instantaneous and time-limit operation.



Time-limit operation ←      → Instantaneous operation



#### Setting the Time Range

##### Setting the Time Range

The time range switch can be used to set the time range. Turn the switch with a flat-blade or Phillips screwdriver.



## Timing Charts

- There is no instantaneous output with the H3DT-N1/L1.

### A2: ON Delay (Power ON Delay)



#### Basic Operation



### B3: Flicker OFF Start (Power ON Start)

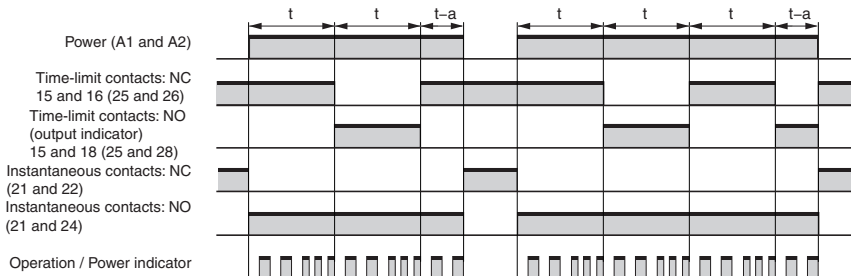

#### Basic Operation

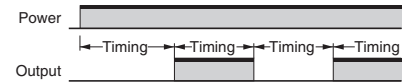

### B4: Flicker ON Start (Power ON Start)

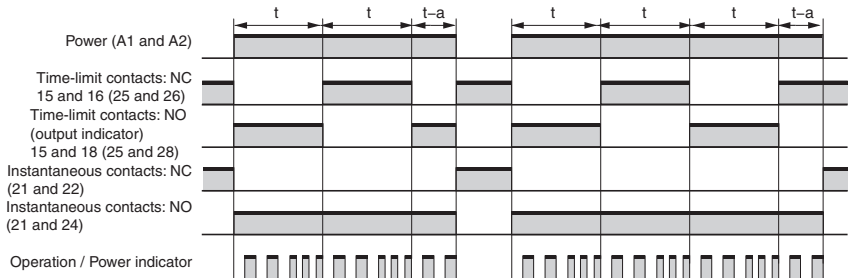

#### Basic Operation



### D: Signal OFF Delay

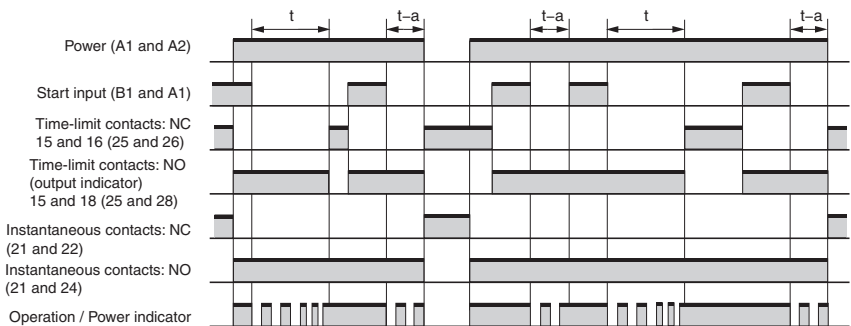

#### Basic Operation

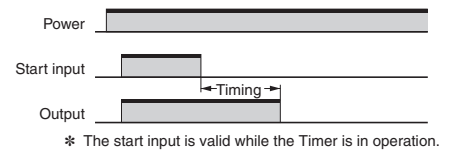

- Note:**
1. The reset time is 0.1 s min. Make sure the signal input time is 0.05 s or longer.
  2. " $t$ " is the set time. " $t-a$ " is a time that is less than the set time.



## E2: Interval (Power ON Start)

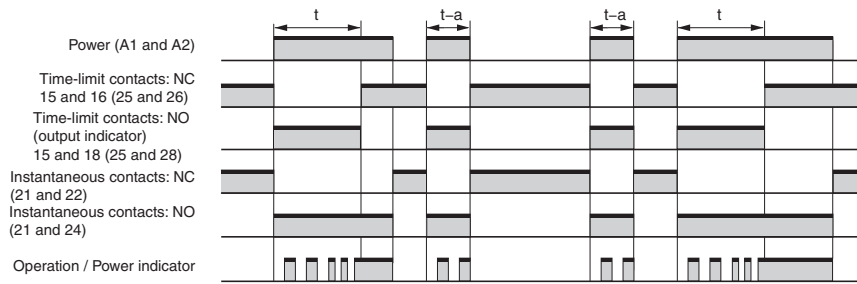

### Basic Operation



## E3: Signal OFF Interval

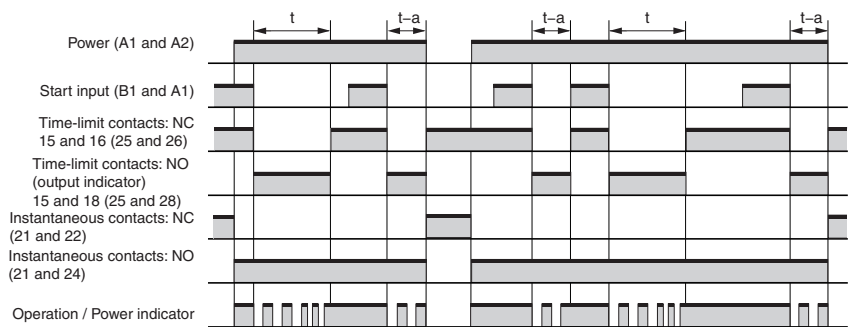

### Basic Operation

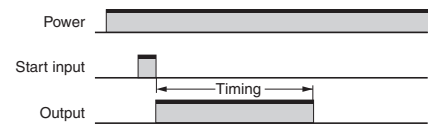

\* The start input is valid while the Timer is in operation.

## F2: Cumulative (ON Delay)

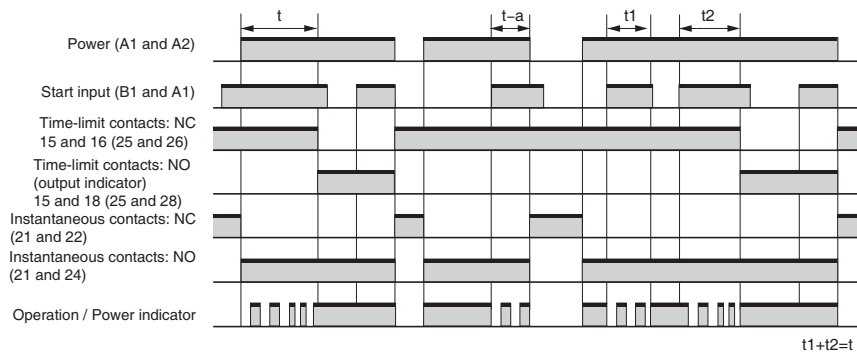

### Basic Operation



Note: Timing is performed while the start input is ON.

## F3: Cumulative (Interval)

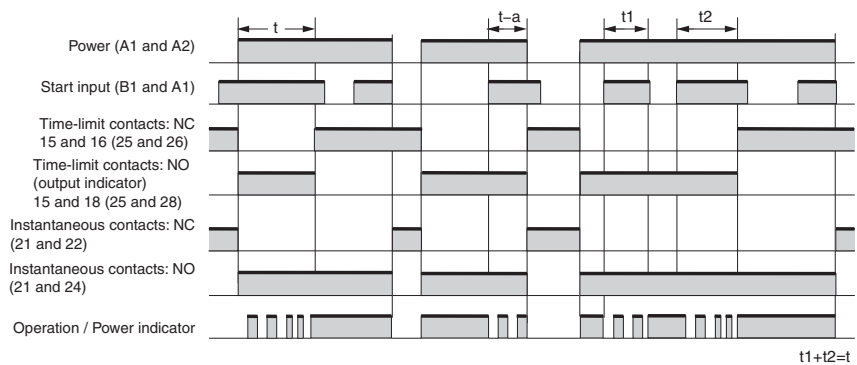

### Basic Operation

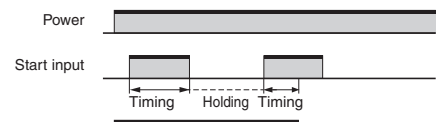

Note: Timing is performed while the start input is ON.

- Note:**
1. The reset time is 0.1 s min. Make sure the signal input time is 0.05 s or longer.
  2. "t" is the set time. "t-a" is a time that is less than the set time.

## A: ON Delay (Signal ON Delay)



### Basic Operation

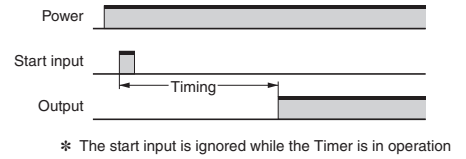

## B: Flicker OFF Start (Signal Start)

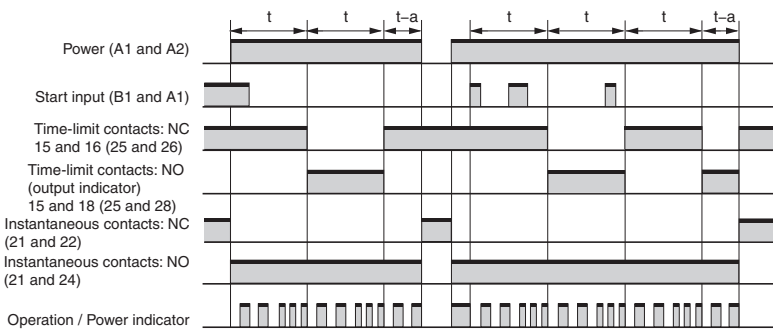

### Basic Operation

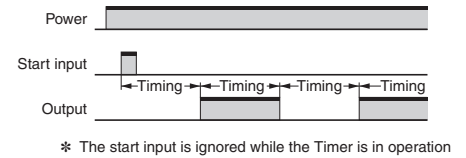

## B2: Flicker ON Start (Signal Start)

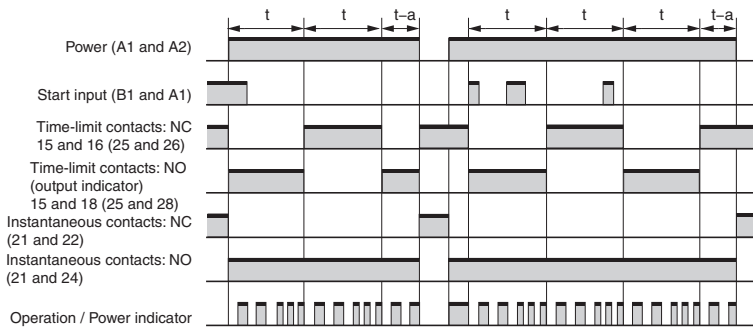

### Basic Operation

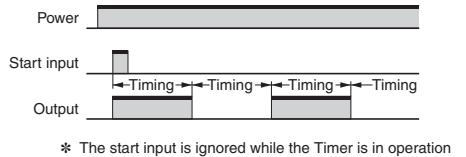

## C: Signal ON/OFF Delay



### Basic Operation

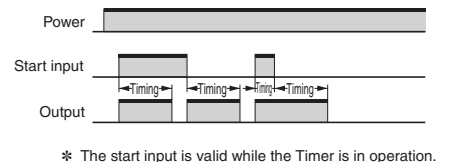

**Note:** 1. The reset time is 0.1 s min. Make sure the signal input time is 0.05 s or longer.  
 2. " $t$ " is the set time. " $t-a$ " is a time that is less than the set time.

**E: Interval (Signal Start)**



**Basic Operation**

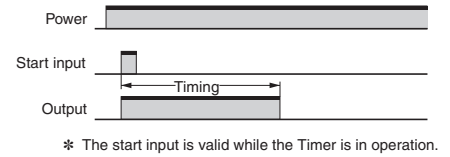

**G: Signal ON/OFF Delay**

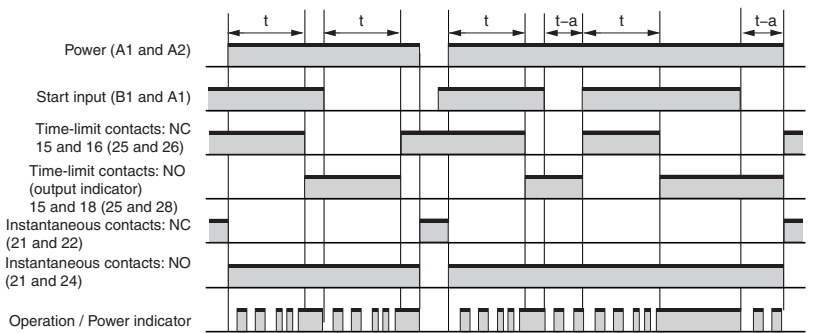

**Basic Operation**

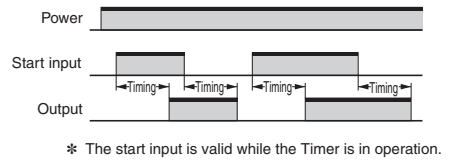

**J: One-shot Output (Signal Start)**



**Basic Operation**

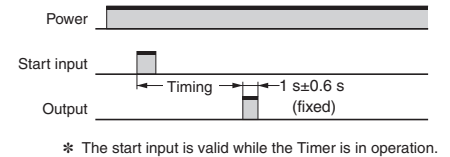

**J2: One-shot Output (Power ON Start)**

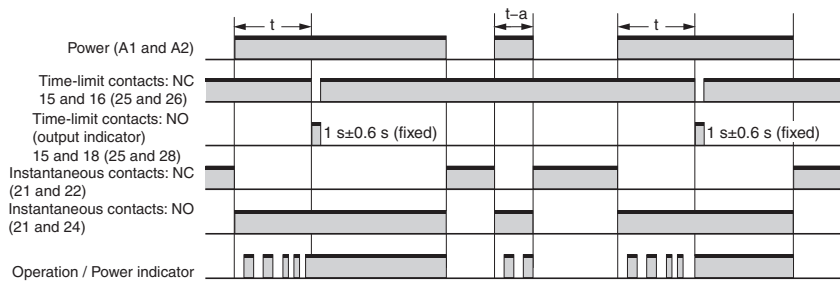

**Basic Operation**

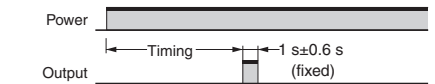

**Note:** 1. The reset time is 0.1 s min. Make sure the signal input time is 0.05 s or longer.  
 2. "t" is the set time. "t-a" is a time that is less than the set time.

# Power ON-delay Timer H3DT-A

- Single Mode Timers with power ON delay operation.



\* CSA conformance evaluation by UL.



For the most recent information on models that have been certified for safety standards, refer to your OMRON website.

## Ordering Information

### List of Models

Supply voltage	Control output	Model	H3DT-A
24 to 240 VAC/DC	Contact output, DPDT (time-limit DPDT)		H3DT-A2
	Contact output, SPDT (time-limit SPDT)		H3DT-A1

### Model Structure

Model	Operating modes	Terminal block	Output type	Mounting method	Safety standards
H3DT-A2	Power ON-delay	8 terminals	Relay, DPDT	DIN Track mounting	cULus (UL508 CSA C22.2 No.14) CCC LR DNV GL * EN61812-1 IEC60664-1 4 kV/2
H3DT-A1		6 terminals	Relay, SPDT		

\* Certification is pending for DNV GL.

## Specifications

### Time Ranges

Time range setting	0.1 s	1 s	10 s	1 min	10 min	1 h	10 h	100 h
Set time range	0.1 to 1.2 s	1 to 12 s	10 to 120 s	1 to 12 min	10 to 120 min	1 to 12 h	10 to 120 h	100 to 1,200 h
Scale numbers	12							

### Ratings

Power supply voltage *1	24 to 240 VAC/DC, 50/60 Hz *2
Allowable voltage fluctuation range	85% to 110% of rated voltage
Power reset	Minimum power-OFF time: 0.1 s
Reset voltage	10% of rated voltage
*3 Power consumption	H3DT-A2 At 240 VAC: 2.2 VA max., at 240 VDC: 0.7 W max., at 24 VDC: 0.3 W max.
	H3DT-A1 At 240 VAC: 1.8 VA max., at 240 VDC: 0.6 W max., at 24 VDC: 0.3 W max.
Rated Insulation Voltage	250 VAC
Control output	Contact output: 5 A at 250 VAC with resistive load (cosφ = 1), 5 A at 30 VDC with resistive load, 0.15 A max. at 125 VDC with resistive load, 0.1A max. at 125 VDC with L/R of 7 ms. The minimum applicable load is 10 mA at 5 VDC (P reference value). Contact materials : Ag-alloy (Recommended fuse: BLN5 (Littelfuse) or 0216005MXEP)
Ambient operating temperature	-20 to 60°C (with no icing)
Storage temperature	-40 to 70°C (with no icing)
Surrounding air operating humidity	25% to 85%

\*1. When using a 24-VDC power supply voltage, there will be an inrush current of approximately 0.5 A. Allow for this inrush current when turning ON and OFF the power supply to the Timer with device with a solid-state output, such as a sensor.

\*2. DC ripple: 20% max.

\*3. The power consumption is the value after the Timer times out.

## Characteristics

<b>Accuracy of operating time</b>	±1% of FS max. (±1% ±10 ms max. at 1.2-s range)	
<b>Setting error</b>	±10% of FS ±0.05 s max.	
<b>Influence of voltage</b>	±0.5% of FS max. (±0.5% ±10 ms max. at 1.2-s range)	
<b>Influence of temperature</b>	±2% of FS max. (±2% ±10 ms max. at 1.2-s range)	
<b>Insulation resistance</b>	100 MΩ min. at 500 VDC	
<b>Dielectric strength</b>	Between charged metal part and operating section: 2,900 VAC 50/60 Hz for 1 min. Between control output terminals and operating circuit: 2,000 VAC 50/60 Hz for 1 min. Between contacts not located next to each other: 1,000 VAC 50/60 Hz for 1 min.	
<b>Impulse withstand test voltage</b>	5 kV between power terminals, 7.4 kV between conductor terminal and operating section	
<b>Noise immunity</b>	Square-wave noise generated by noise simulator (pulse width: 100 ns/1 μs, 1-ns rise): ±1.5 kV	
<b>Static immunity</b>	Malfunction: 4 kV, Destruction: 8 kV	
<b>Vibration resistance</b>	<b>Destruction</b>	0.75-mm single amplitude at 10 to 55 Hz for 2 h each in 3 directions
	<b>Malfunction</b>	0.5-mm single amplitude at 10 to 55 Hz for 10 min each in 3 directions
<b>Shock resistance</b>	<b>Destruction</b>	1,000 m/s <sup>2</sup> 3 times each in 6 directions
	<b>Malfunction</b>	100 m/s <sup>2</sup> 3 times each in 6 directions
<b>Life expectancy</b>	<b>Mechanical</b>	10 million operations min. (under no load at 1,800 operations/h)
	<b>Electrical</b>	100,000 operations min. (5 A at 250 VAC, resistive load at 360 operations/h)
<b>Degree of protection</b>	IP30 (Terminal block: IP20)	
<b>Weight</b>	Approx. 100 g	

## Applicable standards

<b>Safety standards</b>	cULus: UL 508/GSA C22.2 No. 14 EN 61812-1: Pollution degree 2, Overvoltage category III CCC: Pollution degree 2, Overvoltage category II, section GB 14048.5 LR: Category ENV1.2 DNV GL *
<b>EMC</b>	(EMI) EN 61812-1 Radiated Emissions: EN 55011 class B Emission AC Mains: EN 55011 class B Harmonic Current: EN 61000-3-2 Voltage Fluctuations and Flicker: EN 61000-3-3 (EMS) EN 61812-1 Immunity ESD: EN 61000-4-2 Immunity RF-interference: EN 61000-4-3 Immunity Burst: EN 61000-4-4 Immunity Surge: EN 61000-4-5 Immunity Conducted Disturbance: EN 61000-4-6 Immunity Voltage Dip/Interruption: EN 61000-4-11

\* Certification is pending for DNV GL.

## I/O

<b>Input</b>	None
<b>Output</b>	<b>Control output</b> The output is turned ON/OFF according to the operating mode when the value that is set on the dial is reached.

## Relation between H3DT Ambient Temperature and Mounting Interval (Reference Values)

The relation between the ambient temperature and mounting interval is shown in the following graph.

If the Timer is used at 55°C or higher with a mounting interval that is smaller than that shown in the following diagram, the temperature inside the Timer will increase, reducing the life expectancy of internal parts.



### Testing Method

Tested Timer: H3DT-A  
Applied voltage: 240 VAC  
Installation pitch: 0 and 10 mm  
Load current: 5 A

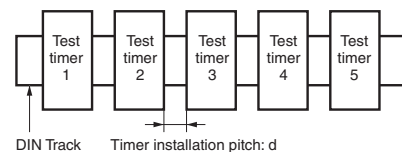

# H3DT-A

## Connections

### Block Diagrams

#### H3DT-A

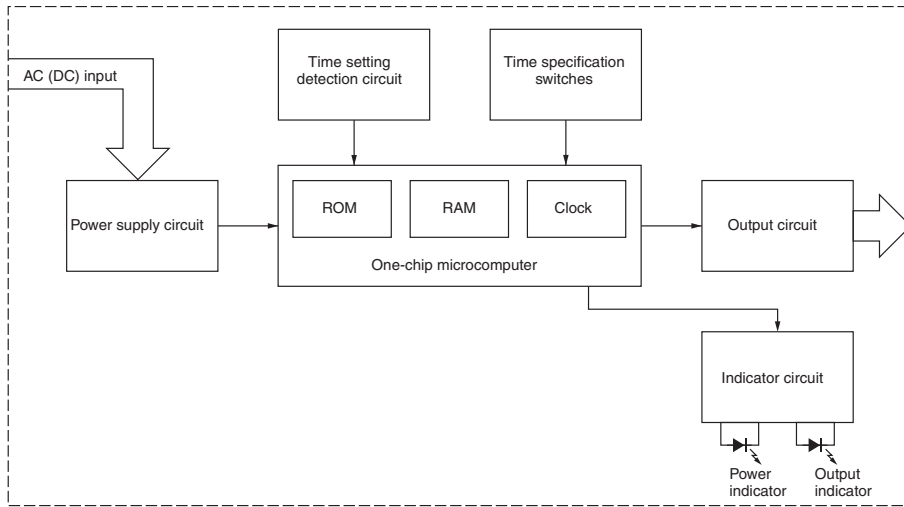

### Terminal Arrangement

H3DT-A1



H3DT-A2

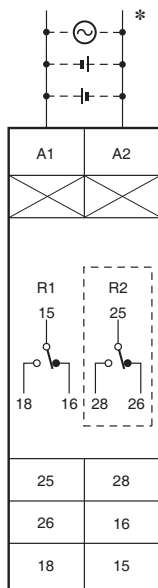

\* The power supply terminals do not have polarity.

(DIN notation)



(DIN notation)



# Nomenclature

## H3DT-A2

Front View

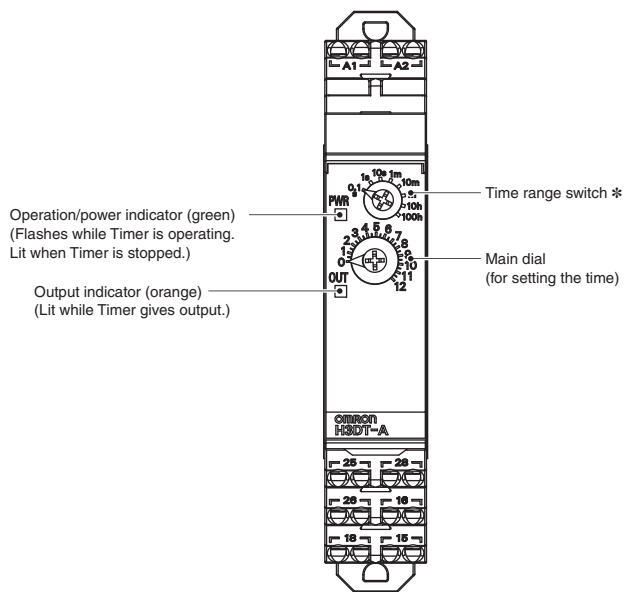

\* If the switch is left between settings, proper operation may not be possible. Make sure that the switch is set properly.  
 Note: The default settings are for 0.1 s.

## H3DT-A1

Front View

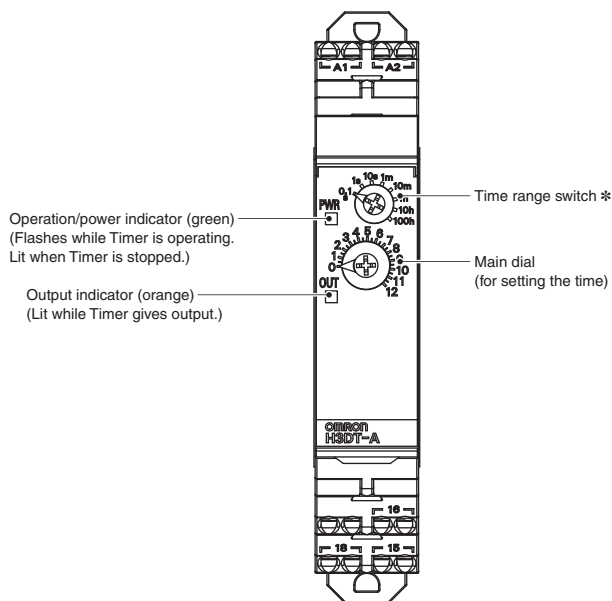

\* If the switch is left between settings, proper operation may not be possible. Make sure that the switch is set properly.  
 Note: The default settings are for 0.1 s.

# Dimensions

(Unit: mm)

## Timers

### H3DT-A

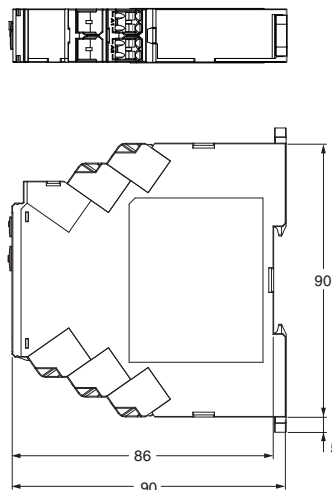
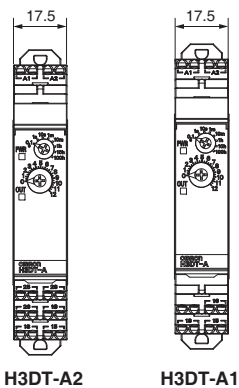

## Track Mounting Products (Sold Separately)

Refer to page 29 for details.

## Options (Order Separately)

### Front Cover

Refer to page 29 for details.

# H3DT-A

## Operating Procedures

### Basic Operation

#### Setting Switches

- Each switch has a snap mechanism that secures the switch at given positions. Set the switch to one of these positions. Do not set it midway between two positions. Malfunction could result from an improper setting.

#### Setting the Time Range

#### Setting the Time Range

The time range switch can be used to set the time range. Turn the switch with a flat-blade or Phillips screwdriver.

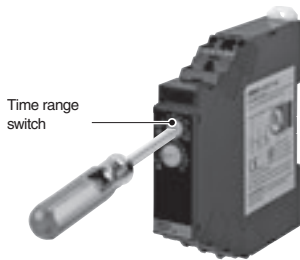

### Timing Charts

#### ON Delay (Power ON Delay)

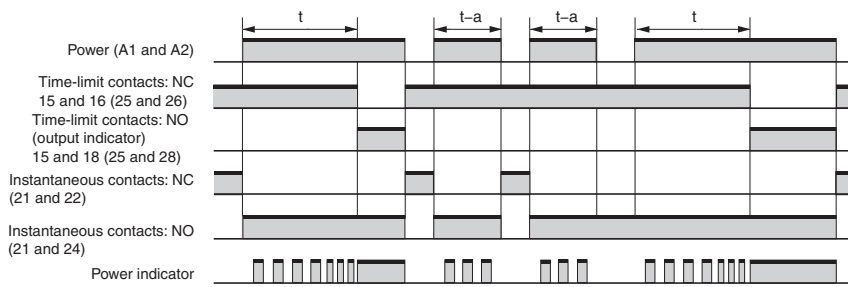

**Note:** 1. The reset time is 0.1 s min.

2. "t" is the set time. "t-a" is a time that is less than the set time.



# Twin Timer H3DT-F

- Switch between flicker-OFF or flicker-ON start mode.
- Independent ON time and OFF time settings.
- Eight time ranges from 0.1 s to 1,200 h.



\* CSA conformance evaluation by UL.



For the most recent information on models that have been certified for safety standards, refer to your OMRON website.

## Ordering Information

### List of Models

Operating modes	Supply voltage	Control output		H3DT-F
Flicker OFF start/flicker ON start	24 to 240 VAC/DC	Contact output: SPDT	Model	H3DK-F

### Model Structure

Model	Operating modes	Terminal block	Output type	Mounting method	Safety standards
H3DT-F	Flicker OFF start/flicker ON start	6 terminals	Relay, SPDT	DIN Track mounting	cULus (UL508 CSA C22.2 No. 14) CCC LR DNV GL * EN 61812-1 IEC 60664-1 4 kV/2

\* Certification is pending for DNV GL.

## Specifications

### Time Ranges

Time range setting	0.1 s	1 s	10 s	1 min	10 min	1 h	10 h	100 h
Set time range	0.1 to 1.2 s	1 to 12 s	10 to 120 s	1 to 12 min	10 to 120 min	1 to 12 h	10 to 120 h	100 to 1,200 h
Scale numbers	12							

### Ratings

Power supply voltage #1	24 to 240 VAC/DC, 50/60 Hz *2
Allowable voltage fluctuation range	85% to 110% of rated voltage
Power reset	Minimum power-OFF time: 0.1 s
Reset voltage	10% of rated voltage
Power consumption	H3DT-F At 240 VAC: 1.9VA max., at 240 VDC: 0.6W max., at 24 VDC: 0.3W max.
Rated Insulation Voltage	250 VAC
Control output	Contact output: 5 A at 250 VAC with resistive load (cosφ = 1), 5 A at 30 VDC with resistive load, 0.15 A max. at 125 VDC with resistive load, 0.1 A max. at 125 VDC with L/R of 7 ms. The minimum applicable load is 10 mA at 5 VDC (P reference value). Contact materials : Ag-alloy (Recommended fuse: BLN5 (Littelfuse) or 0216005MXEP)
Ambient operating temperature	-20 to 60°C (with no icing)
Storage temperature	-40 to 70°C (with no icing)
Surrounding air operating humidity	25% to 85%

\*1. When using a 24-VDC power supply voltage, there will be an inrush current of approximately 0.5 A. Allow for this inrush current when turning ON and OFF the power supply to the Timer with device with a solid-state output, such as a sensor.

\*2. DC ripple: 20% max.

## Characteristics

<b>Accuracy of operating time</b>	±1% of FS max. (±1% ±10 ms max. at 1.2-s range)	
<b>Setting error</b>	±10% of FS ±0.05 s max.	
<b>Influence of voltage</b>	±0.5% of FS max. (±0.5% ±10 ms max. at 1.2-s range)	
<b>Influence of temperature</b>	±2% of FS max. (±2% ±10 ms max. at 1.2-s range)	
<b>Insulation resistance</b>	100 MΩ min. at 500 VDC	
<b>Dielectric strength</b>	Between charged metal part and operating section: 2,900 VAC 50/60 Hz for 1 min. Between control output terminals and operating circuit: 2,000 VAC 50/60 Hz for 1 min. Between contacts not located next to each other: 1,000 VAC 50/60 Hz for 1 min.	
<b>Impulse withstand test voltage</b>	5 kV between power terminals, 7.4 kV between conductor terminal and operating section	
<b>Noise immunity</b>	Square-wave noise generated by noise simulator (pulse width: 100 ns/1 μs, 1-ns rise): ±1.5 kV	
<b>Static immunity</b>	Malfunction: 4 kV, Destruction: 8 kV	
<b>Vibration resistance</b>	<b>Destruction</b>	0.75-mm single amplitude at 10 to 55 Hz for 2 h each in 3 directions
	<b>Malfunction</b>	0.5-mm single amplitude at 10 to 55 Hz for 10 min each in 3 directions
<b>Shock resistance</b>	<b>Destruction</b>	1,000 m/s <sup>2</sup> 3 times each in 6 directions
	<b>Malfunction</b>	100 m/s <sup>2</sup> 3 times each in 6 directions
<b>Life expectancy</b>	<b>Mechanical</b>	10 million operations min. (under no load at 1,800 operations/h)
	<b>Electrical</b>	100,000 operations min. (5 A at 250 VAC, resistive load at 360 operations/h)
<b>Degree of protection</b>	IP30 (Terminal block: IP20)	
<b>Weight</b>	Approx. 90 g	

## Applicable standards

<b>Safety standards</b>	cULus: UL 508/CSA C22.2 No. 14 EN 61812-1: Pollution degree 2, Overvoltage category III CCC: Pollution degree 2, Overvoltage category II, section GB 14048.5 LR: Category ENV1.2 DNV GL *
<b>EMC</b>	(EMI) EN 61812-1 Radiated Emissions: EN 55011 class B Emission AC Mains: EN 55011 class B Harmonic Current: EN 61000-3-2 Voltage Fluctuations and Flicker: EN 61000-3-3 (EMS) EN 61812-1 Immunity ESD: EN 61000-4-2 Immunity RF-interference: EN 61000-4-3 Immunity Burst: EN 61000-4-4 Immunity Surge: EN 61000-4-5 Immunity Conducted Disturbance: EN 61000-4-6 Immunity Voltage Dip/Interruption: EN 61000-4-11

\* Certification is pending for DNV GL.

## I/O

<b>Input</b>	None
<b>Output</b>	<b>Control output</b> Output is turned ON/OFF according to the time set on the ON time setting dial and OFF time setting dial.

## Relation between H3DT Ambient Temperature and Mounting Interval (Reference Values)

The relation between the ambient temperature and mounting interval is shown in the following graph.

If the Timer is used at 55°C or higher with a mounting interval that is smaller than that shown in the following diagram, the temperature inside the Timer will increase, reducing the life expectancy of internal parts.

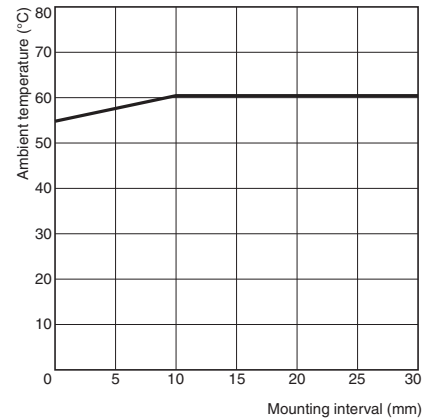

## Testing Method

Tested Timer: H3DT-F  
Applied voltage: 240 VAC  
Installation pitch: 0 and 10 mm  
Load current: 5 A

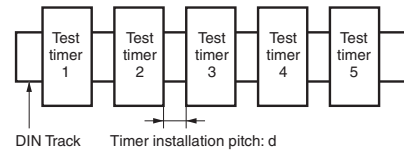

# Connections

## Block Diagrams

H3DT-F



## Terminal Arrangement

H3DT-F



(DIN notation)

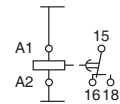

\* The power supply terminals do not have polarity.

## Nomenclature

H3DT-F

Front View



# H3DT-F

## Dimensions

(Unit: mm)

### Timers

#### H3DT-F



### Track Mounting Products (Sold Separately)

Refer to page 29 for details.

### Options (Order Separately)

Front Cover

Refer to page 29 for details.

## Operating Procedures

### Basic Operation

#### Setting the Time Ranges

##### Setting the Time Ranges

Use the ON time range switch to set the ON time range and the OFF time range switch to set the OFF time range. Turn the switches with a flat-blade or Phillips screwdriver.



#### Setting the ON/OFF Start Switch

##### Setting an ON Start or OFF Start

The ON/OFF start switch can be used to switch between ON-start and OFF-start operation.



#### Setting the Times

##### Setting the Times

Use the ON time setting dial and the OFF time setting dial to set the ON time and OFF time.



## Timing Charts



**Note:** The reset time is 0.1 s min.

# Star-delta Timer H3DT-G

• Set two time ranges between 1 and 120 s with one Timer.



\* CSA conformance evaluation by UL.



For the most recent information on models that have been certified for safety standards, refer to your OMRON website.

## Ordering Information

### List of Models

Operating modes	Supply voltage	Control output	H3DT-G
Star-delta Timer	24 to 240 VAC/DC	Contact outputs Delta circuit: SPDT, Star circuit: SPDT	Model H3DT-G

### Model Structure

Model	Terminal block	Operating/resetting method	Output type	Mounting method	Safety standards
H3DT-G	8 terminals	Time-limit operation/ self-resetting	Time-limit (relay) Star circuit: SPDT Delta circuit: SPDT	DIN Track mounting	cULus (UL 508 CSA C22.2 No. 14) CCC LR DNV GL * EN 61812-1 IEC 60664-1 4 kV/2

\* Certification is pending for DNV GL.

## Specifications

### Time Ranges

Time range setting	t1x1	t1x10
Star set time (t1) range	1 to 12 s	10 to 120 s
Star-Delta transfer time (t2)	Select from 0.05, 0.1, 0.25, or 0.5 s.	

### Ratings

Power supply voltage #1	24 to 240 VAC/DC, 50/60 Hz #2
Allowable voltage fluctuation range	85% to 110% of rated voltage
Power reset	Minimum power-OFF time: 0.1 s
Reset voltage	10% of rated voltage
Power consumption	H3DT-G At 240 VAC: 1.9 VA max., at 240 VDC: 0.6 W max., at 24 VDC: 0.3 W max.
Rated Insulation Voltage	250 V
Control output	Contact output: 5 A at 250 VAC with resistive load (cosφ = 1), 5 A at 30 VDC with resistive load 0.15 A max at 125 VDC with resistive load, 0.1 A max at 125 VDC with L/R of 7 ms. The minimum applicable load is 10 mA at 5 VDC (P reference value). Contact materials : Ag-alloy (Recommended fuse: BLN5 (Littelfuse) or 0216005MXEP)
Ambient operating temperature	-20 to 60°C (with no icing)
Storage temperature	-40 to 70°C (with no icing)
Surrounding air operating humidity	25% to 85%

\*1. When using a 24-VDC power supply voltage, there will be an inrush current of approximately 0.5 A. Allow for this inrush current when turning ON and OFF the power supply to the Timer with device with a solid-state output, such as a sensor.  
\*2. DC ripple: 20% max.

## Characteristics

Accuracy of operating time	±1% of FS max.	
Setting error	±10% of FS ±0.05 s max.	
Transfer time	Total error ± (25% of transfer time + 5 ms) max.	
Influence of voltage	±0.5% of FS max.	
Influence of temperature	±2% of FS max.	
Insulation resistance	100 MΩ min. at 500 VDC	
Dielectric strength	Between charged metal part and operating section: 2,900 VAC 50/60 Hz for 1 min. Between control output terminals and operating circuit: 2,000 VAC 50/60 Hz for 1 min. Between contacts not located next to each other: 1,000 VAC 50/60 Hz for 1 min.	
Impulse withstand test voltage	5 kV between power terminals, 7.4 kV between conductor terminal and operating section	
Noise immunity	Square-wave noise generated by noise simulator (pulse width: 100 ns/1 μs, 1-ns rise): ±1.5 kV	
Static immunity	Malfunction: 4 kV, Destruction: 8 kV	
Vibration resistance	Destruction	0.75-mm single amplitude at 10 to 55 Hz for 2 h each in 3 directions
	Malfunction	0.5-mm single amplitude at 10 to 55 Hz for 10 min each in 3 directions
Shock resistance	Destruction	1,000 m/s <sup>2</sup> 3 times each in 6 directions
	Malfunction	100 m/s <sup>2</sup> 3 times each in 6 directions
Life expectancy	Mechanical	10 million operations min. (under no load at 1,800 operations/h)
	Electrical	100,000 operations min. (5 A at 250 VAC, resistive load at 360 operations/h)
Degree of protection	IP30 (Terminal block: IP20)	
Weight	Approx. 100 g	

## Applicable standards

Safety standards	cULus: UL 508/CSA C22.2 No. 14 EN 61812-1: Pollution degree 2, Overvoltage category III CCC: Pollution degree 2, Overvoltage category II, section GB 14048.5 LR: Category ENV1.2 DNV GL *
EMC	(EMI) EN 61812-1 Radiated Emissions: EN 55011 class B Emission AC Mains: EN 55011 class B Harmonic Current: EN 61000-3-2 Voltage Fluctuations and Flicker: EN 61000-3-3 (EMS) EN 61812-1 Immunity ESD: EN 61000-4-2 Immunity RF-interference: EN 61000-4-3 Immunity Burst: EN 61000-4-4 Immunity Surge: EN 61000-4-5 Immunity Conducted Disturbance: EN 61000-4-6 Immunity Voltage Dip/Interruption: EN 61000-4-11

\* Certification is pending for DNV GL.

## I/O

Input	None
Output	Control output The star output is turned OFF when the dial set value is reached and the delta output is turned ON after the preset transfer time elapses.

## Relation between H3DT Ambient Temperature and Mounting Interval (Reference Values)

The relation between the ambient temperature and mounting interval is shown in the following graph.

If the Timer is used at 55°C or higher with a mounting interval that is smaller than that shown in the following diagram, the temperature inside the Timer will increase, reducing the life expectancy of internal parts.



## Testing Method

Tested Timer: H3DT-G  
Applied voltage: 240 VAC  
Installation pitch: 0 and 10 mm  
Load current: 5 A

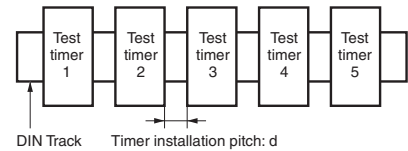

# Connections

## Block Diagrams

H3DT-G



## Terminal Arrangement

H3DT-G



(DIN notation)

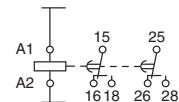

\* The power supply terminals do not have polarity.

## Nomenclature

H3DT-G

Front View

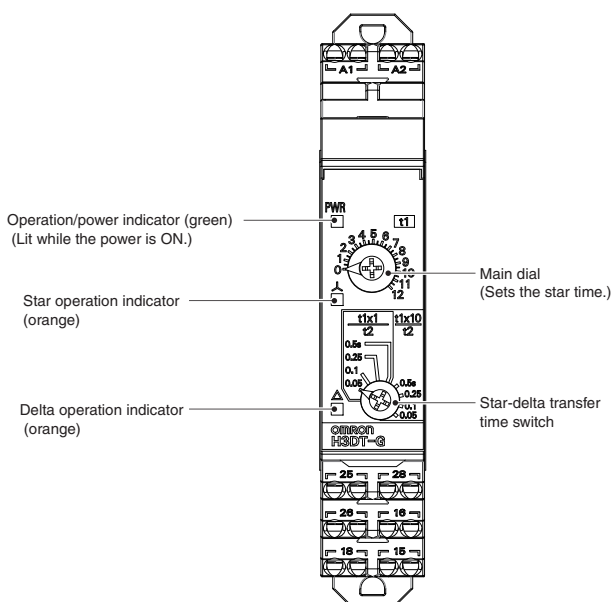

# H3DT-G

## Dimensions

(Unit: mm)

### Timers

H3DT-G

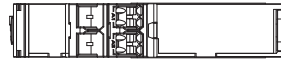

### Track Mounting Products (Sold Separately)

Refer to page 29 for details.

### Options (Order Separately)

#### Front Cover

Refer to page 29 for details.

## Operating Procedures

### Basic Operation

#### Setting the Time Ranges

#### Setting the Time

#### Setting the Delta Time Range (t1) and the Star-delta Transfer Time (t2)

If the Delta Time Range (t1) is set to  $\times 1$  (1 to 12 s), set the Star-delta Transfer Time on side (A) (the side labeled t1  $\times 1$ ).  
 If the Delta Time Range (t1) is set to  $\times 10$  (10 to 120 s), set the Star-delta Transfer Time on side (B) (the side labeled t1  $\times 10$ ).

#### Setting the Time

The start time is set with the main dial.

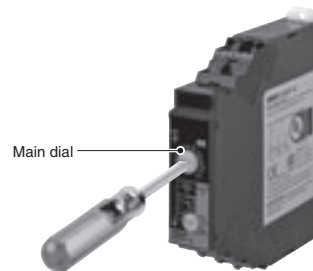
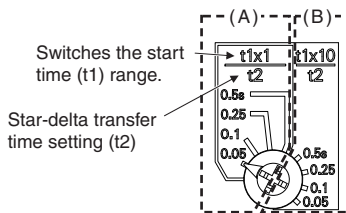

### Timing Chart

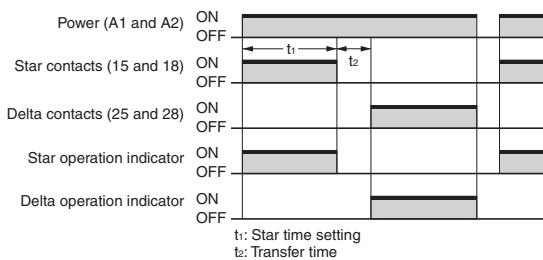

**Note:** 1. The reset time is 0.1 s min.  
 2. "t1" is the start set time. "t2" is the transfer time.



# Power OFF-delay Timer H3DT-H

- Set two time ranges with each Timer, from 0.1 to 12 seconds for the S Series and from 1.0 to 120 seconds for the L Series.



\* CSA conformance evaluation by UL.



For the most recent information on models that have been certified for safety standards, refer to your OMRON website.

## Ordering Information

### List of Models

				H3DT-H	
Operating modes		Supply voltage	Control output	S Series (time range: 0.1 to 12 s)	L Series (time range: 1.0 to 120 s)
Power OFF Delay	100 to 120 VAC	Contact output: SPDT	Model	H3DT-HCS	H3DT-HCL
	200 to 240 VAC			H3DT-HDS	H3DT-HDL
	24 to 48 VAC/DC			H3DT-HBS	H3DT-HBL

### Model Structure

Model	Terminal block	Operating/resetting method	Output type	Mounting method	Safety standards
H3DT-H	6 terminals	Instantaneous operation/ time-limit reset	Relay, SPDT	DIN Track mounting	cULus (UL 508 CSA C22.2 No. 14) CCC LR DNV GL * EN 61812-1 IEC 60664-1 4 kV/2

\* Certification is pending for DNV GL.

## Specifications

### Time Ranges

	S Series		L Series	
Time range setting	x0.1	x1	x1	x10
Set time range	0.1 to 1.2 s	1 to 12 s	1 to 12 s	10 to 120 s
Power ON time	0.1 s min.		0.3 s min.	
Scale numbers	12			

### Ratings

Supply voltage	H3DT-HCS/-HCL	100 to 120 VAC, 50/60 Hz
	H3DT-HDS/-HDL	200 to 240 VAC, 50/60 Hz
	H3DT-HBS/-HBL	24 to 48 VAC/DC, 50/60 Hz *1
Allowable voltage fluctuation range	85% to 110% of rated voltage	
Power consumption	H3DT-HCS	At 120 VAC: 8.7 VA max.
	H3DT-HCL	At 120 VAC: 8.8 VA max.
	H3DT-HDS	At 240 VAC: 21.6 VA max.
	H3DT-HDL	At 240 VAC: 21.7 VA max.
	H3DT-HBS/-HBL	At 48 VAC: 1.0 VA max., at 24 VDC: 0.4 W max.
Timer operation starting voltage	30% or less of power supply voltage	
Rated Insulation Voltage	250 VAC	
Control output	Contact output, 5 A at 250 VAC with resistive load (cosφ = 1), 5 A at 30 VDC with resistive load Contact materials : Ag-alloy (Recommended fuse: BLN5 (Littelfuse) or 0216005MXEP)	
Ambient operating temperature	-20 to 60°C (with no icing)	
Storage temperature	-40 to 70°C (with no icing)	
Surrounding air operating humidity	25% to 85%	

\* DC ripple: 20% max.

## Characteristics

<b>Accuracy of operating time</b>	±1% of FS max. (±1% ±10 ms max. at 1.2-s range)	
<b>Setting error</b>	±10% of FS ±0.05 s max.	
<b>Influence of voltage</b>	±0.5% of FS max. (±0.5% ±10 ms max. at 1.2-s range)	
<b>Influence of temperature</b>	±2% of FS max. (±2% ±10 ms max. at 1.2-s range)	
<b>Insulation resistance</b>	100 MΩ min. at 500 VDC	
<b>Dielectric strength</b>	Between charged metal part and operating section: 2,900 VAC 50/60 Hz for 1 min. Between control output terminals and operating circuit: 2,000 VAC 50/60 Hz for 1 min. Between contacts not located next to each other: 1,000 VAC 50/60 Hz for 1 min.	
<b>Impulse withstand test voltage</b>	Between power supply terminals: 1 kV for 24-VAC/DC and 48-VAC/DC models, 5 kV for all other models. Between conductor terminal and operating section: 7.4 kV	
<b>Noise immunity</b>	Square-wave noise generated by noise simulator (pulse width: 100 ns/1 μs, 1-ns rise): ±1.5 kV (between power supply terminals)	
<b>Static immunity</b>	Malfunction: 4 kV, Destruction: 8 kV	
<b>Vibration resistance</b>	<b>Destruction</b>	0.75-mm single amplitude at 10 to 55 Hz for 2 h each in 3 directions
	<b>Malfunction</b>	0.5-mm single amplitude at 10 to 55 Hz for 10 min each in 3 directions
<b>Shock resistance</b>	<b>Destruction</b>	1,000 m/s <sup>2</sup> 3 times each in 6 directions
	<b>Malfunction</b>	100 m/s <sup>2</sup> 3 times each in 6 directions
<b>Life expectancy</b>	<b>Mechanical</b>	10 million operations min. (under no load at 1,800 operations/h)
	<b>Electrical</b>	100,000 operations min. (5 A at 250 VAC, resistive load at 360 operations/h)
<b>Degree of protection</b>	IP30 (Terminal block: IP20)	
<b>Weight</b>	Approx. 90 g	

## Applicable standards

<b>Safety standards</b>	cULus: UL 508/CSA C22.2 No. 14 EN 61812-1: Pollution degree 2, Overvoltage category III CCC: Pollution degree 2, Overvoltage category II, section GB 14048.5 LR: Category ENV1.2 DNV GL *	
	<b>EMC</b>	(EMI)
Radiated Emissions:		EN 55011 class B
Emission AC Mains:		EN 55011 class B
Harmonic Current:		EN 61000-3-2
Voltage Fluctuations and Flicker:		EN 61000-3-3
(EMS)		EN 61812-1
Immunity ESD:		EN 61000-4-2
Immunity RF-interference:		EN 61000-4-3
Immunity Burst:		EN 61000-4-4
Immunity Surge:		EN 61000-4-5
Immunity Conducted Disturbance:	EN 61000-4-6	
Immunity Voltage Dip/Interruption:	EN 61000-4-11	

\* Certification is pending for DNV GL.

## I/O

<b>Input</b>	None	
<b>Output</b>	<b>Control output</b>	The Timer operates as soon as the Timer is turned ON. The Timer starts timing when the power is turned OFF and the output is turned OFF when the time set on the dial elapses.

## Relation between H3DT Ambient Temperature and Mounting Interval (Reference Values)

The relation between the ambient temperature and mounting interval is shown in the following graph.

If the Timer is used at 55°C or higher with a mounting interval that is smaller than that shown in the following diagram, the temperature inside the Timer will increase, reducing the life expectancy of internal parts.



## Testing Method

Tested Timer: H3DT-H  
Applied voltage: 240 VAC  
Installation pitch: 0 and 10 mm  
Load current: 5 A



# Connections

## Block Diagrams

H3DT-H



## Terminal Arrangement

H3DT-H

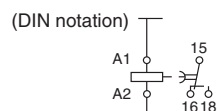
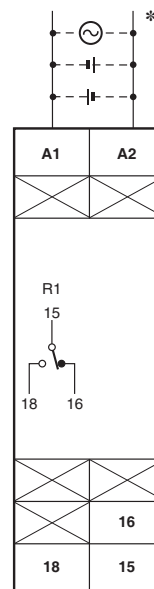

**Note:** The above figure shows the terminal arrangement for a 24 to 48-VAC/DC model. Models with 100 to 120-VAC or 200 to 240-VAC power input do not have a DC input.

\* The power supply terminals do not have polarity.

## Nomenclature

H3DT-H

Front View

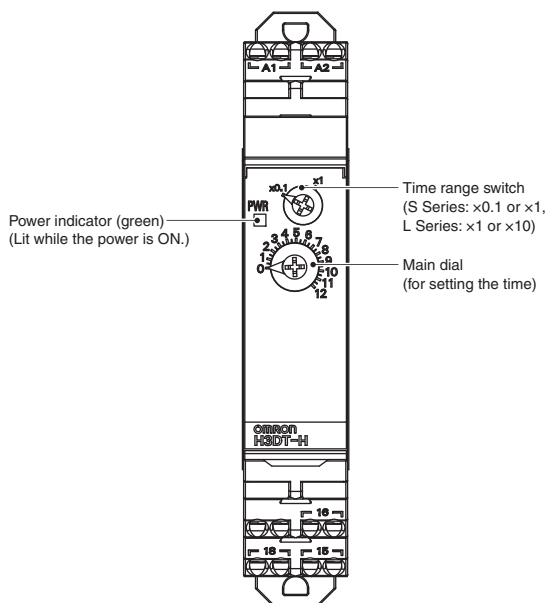

# H3DT-H

## Dimensions

(Unit: mm)

### Timers

#### H3DT-H

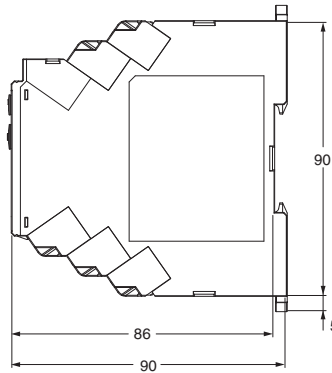

### Track Mounting Products (Sold Separately)

Refer to page 29 for details.

### Options (Order Separately)

#### Front Cover

Refer to page 29 for details.

## Operating Procedures

### Basic Operation

#### Setting the Time Ranges

#### Setting the Time Ranges

The scale multiplier can be changed with the timer range switch. It can be changed between  $\times 0.1$  s and  $\times 1$  s for an S-series Timer and between  $\times 1$  s and  $\times 10$  s for an L-series Timer.



#### Setting the Time

#### Setting the Time

The operation time is set with the main dial.

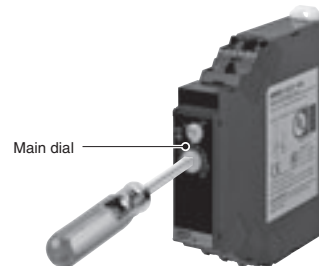

## Timing Charts



## Track Mounting Products (Sold Separately)

DIN Track  
PFP-100N  
PFP-50N

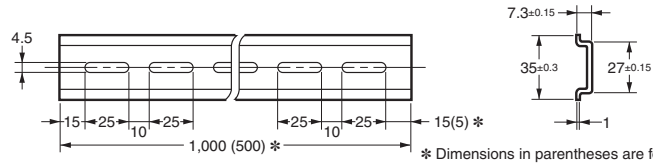
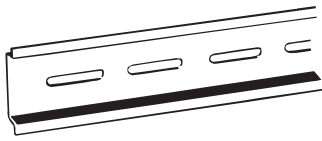

DIN Track  
PFP-100N2

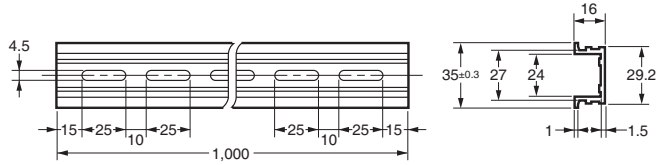
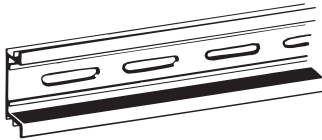

End Plate  
PFP-M

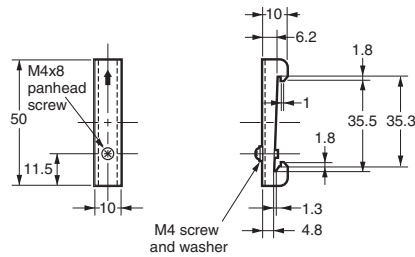
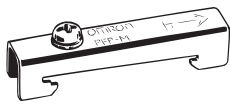

Spacer  
PFP-S

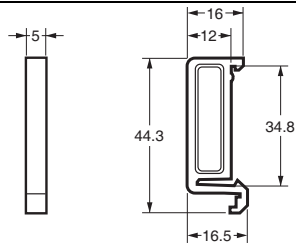
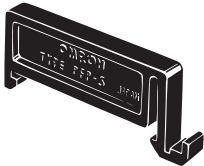

**Note:** 1. Order the above products in multiples of 10.  
2. The Tracks conform to DIN standards.

## Options (Order Separately)

Front Cover  
Y92A-D1A

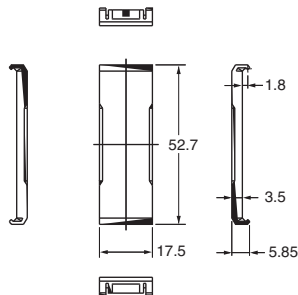
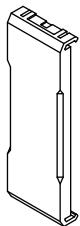





## Safety Precautions

Refer to *Safety Precautions for All Timers*.

### Format of Warning Indications

 <b>CAUTION</b>	Indicates a potentially hazardous situation which, if not avoided, may result in minor or moderate injury or in property damage.
<b>Precautions for Safe Use</b>	Indicates supplementary comments on what to do or avoid doing, to use the product safely.
<b>Precautions for Correct Use</b>	Includes operating precautions to ensure that the product will operate properly and that performance and functions will not be adversely affected.

### Meaning of Graphic Symbols for Ensuring Product Safety

	Indicates the possibility of electric shock under specific conditions.
	Indicates the instructions of unspecified prohibited action.
	Indicates the possibility of injuries, such as electric shock by disassembling the device, prohibiting disassembly.
	Indicates the instructions of unspecified general action.

### CAUTION

Switching arcs or relay heating may cause fire or explosion. Do not use the Timer in the presence of inflammable or explosive gases. 

The H3DT Series uses a transformerless power supply system. An electrical shock may occur if an input terminal is touched while power is being supplied. 

The inrush current will depend on the type of load and may influence the contact switching frequency and number of operations. Check both the rated current and the inrush current, and allow leeway in the circuit design. 

The life of the output relay largely depends on the switching current and other switch conditions. Consider the actual application conditions and do not exceed the rated load or electrical life. If the output relay is used beyond its service life, the contacts may fuse or burning may occur. Also, never exceed the rated load current. When using a heater, also place a thermal switch in the load circuit. 

Do not remove the external case. 

Minor electric shock, fire, or equipment failure may sometimes occur. Do not disassemble, modify, or repair the Timer or touch any internal parts. 

### Precautions for Safe Use

- Rapid changes in temperature or high humidity may cause condensation in Timer circuits, possibly resulting in malfunction or damage to components. Check the application environment.
- Use the Timer within the ambient operating temperature and ambient operating humidity ranges given for the Timer model you are using.
- Do not use or store a Timer in the following locations.
  - Locations subject to water, oil, or chemicals
  - Outdoor locations or under direct sunlight
  - Locations subject to dust or corrosive gases (sulfurizing gases, ammonia, chloride gas, silicon gas, etc.)
  - Locations subject to vibration and large shocks
  - Locations subject to wind and rain
  - Locations subject to insects or small animals
- Each switch has a snap mechanism that secures the switch at given positions. Set each switch to one of these positions. Do not set a switch midway between two positions. Malfunction or failure could result from an improper setting.
- Separate the Timer from any sources of excessive static electricity, such as forming materials and pipes carrying power or liquid materials.
- Maintain the variations in the power supply voltage to within the specified allowable range.
- If a voltage that exceeds the rating is applied, internal components may be destroyed.
- The terminal block may be damaged if you insert a screwdriver in the release hole with excessive force.
- Do not wire anything to the release holes.
- Do not tilt or twist a flat-blade screwdriver while it is inserted into a release hole on the terminal block. The terminal block may be damaged.
- Insert a flat-blade screwdriver into the release holes at an angle. The terminal block may be damaged if you insert the screwdriver straight in.
- Do not allow the flat-blade screwdriver to fall out while it is inserted into a release hole.
- Do not bend a wire past its natural bending radius or pull on it with excessive force. Doing so may cause the wire disconnection.
- Do not insert more than one wire into each terminal insertion hole.
- To prevent wiring materials from smoking or ignition, use the wiring materials given in the following table.

Recommended wire	Stripping length	
	With Ferrules	Without Ferrules
0.25 to 1.5mm <sup>2</sup> /AWG24 to 16	10 mm	8 mm

**Note:** Please use Ferrules with UL certification (R/C).

- Use only the specified wires for wiring.
- When wiring the terminals, allow some leeway in the wire length.
- Install and clearly label a switch or circuit breaker so that the operator can quickly turn OFF the power supply.
- If the Timer is left in the timed out condition for a long period of time at high temperatures, internal components (such as electrolytic capacitors) may deteriorate quickly.
- The exterior of the Timer may be damaged by organic solvents (such as thinners or benzene), strong alkali, or strong acids.
- For Timers with AC power input, use a commercial power supply for the power supply voltage. Although some inverters give 50/60 Hz as the output frequency, do not use an inverter output as the power supply for a Timer. Doing so may result in smoking or burning due to internal temperature increases in the Timer.
- When disposing of the Timer, observe all local ordinances as they apply.

- The Timer may not operate properly in locations that are subject to sulfide gas, such as in sewers or incinerators. Products that are suitable for operation in sulfide gas are not available for OMRON Timers or general control devices. Seal the Timer to isolate it from sulfide gas. If the Timer cannot be sealed, OMRON can make special products with resistance to sulfide gas for some Timers. Ask your OMRON representative for details.
- Confirm that the power and output indicators are operating normally. Depending on the operating environment, the indicators and plastic parts may deteriorate faster than expected, causing the indicators to fail. Periodically perform inspections and replacements.

**Precautions for Correct Use**

Be sure you understand the contents of this document and handle the Timers according to the instructions provided.

**Changing Switch Settings**

Do not change the time unit, operating mode, or INIT/ TIME switch while the power is being supplied to the Timer. Doing so may result in malfunction. Turn OFF the power supply before changing the setting of any switch.

**Mounting and Dismounting**

- Although there are no particular mounting restrictions, the Timer should be mounted as horizontally as possible.
- To mount the Timer to a DIN Track, hook the Timer onto the DIN Track and press the Timer in the direction of the arrow until you hear it lock into place.

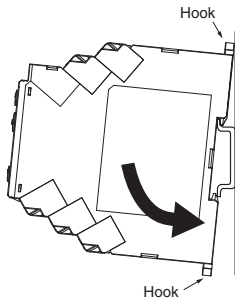

- To remove the Timer, insert a screwdriver into the hook on the top or bottom and pull out the hook to release the Timer.

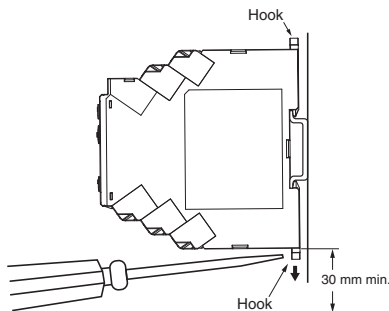

- It will be easier to mount and dismount the Timer if a distance of 30 mm or more is provided between the bottom of the Timer and other equipment.

**Screw Mounting**

1. Pull out the two hooks on the back of the Timer to the outside until you hear them click in place.
2. Insert M3 screws into the hook holes and secure the Timer.

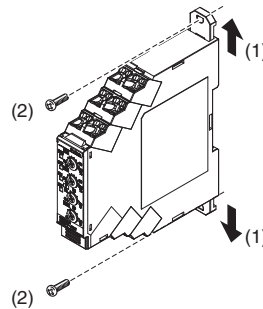

**Mounting Hole Dimensions**

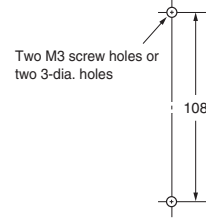

**Note:** Pull out the hooks to mount the Relay with screws.

**Power Supply**

- The power supply can be connected to the power input terminals without considering polarity.
- A DC power supply can be connected if its ripple factor is 20% or less and the average voltage is within the allowable voltage fluctuation range of the Timer.
- For the power supply of the input device, use an isolating transformer in which the primary and secondary windings are mutually isolated and the secondary winding is not grounded. (H3DT-N and H3DT-L only)
- The H3DT-H has a large inrush current. Provide sufficient power supply capacity. If the power supply capacity is too small, there may be delays in turning ON the output.

**Relationship between Input and Power Supply Circuits (H3DT-N/L)**



- The input circuit and the power supply circuit are configured independently. The input circuit can be turned ON and OFF without considering the ON/OFF state of the power supply. A voltage equivalent to the power supply voltage is also applied to the input circuit.

- If a relay or transistor is connected to two or more Timers, the input terminals of those Timers must be wired properly so that they will not be different in phase or the terminals will be short-circuited to one another. Always use the same power supply phases.

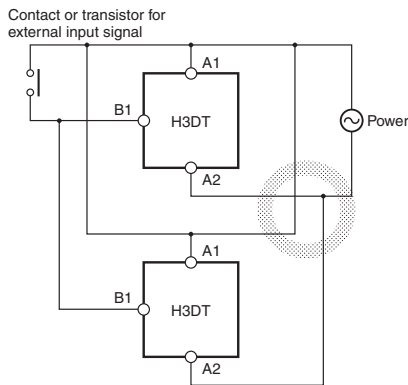

- The power supply circuits for H3DT-series Timers use switching mode. Therefore, if there is a transformer or other device with a large inductance component on the power supply line, the inductance will cause a reverse voltage. If that occurs, insert a CR filter in the power supply line to reduce the reverse voltage.

## Environment

- When using the Timer in an area with excessive electronic noise, separate the Timer and input device as far as possible from the noise sources. It is also recommended to shield the input signal wiring to prevent electronic interference.
- The external impulse voltage entering across the power supply terminals has been checked against a  $\pm 1.2 \times 50 \mu\text{s}$  standard waveform according to JEC-210, Impulse Voltage/Current Test, of The Institute of Electrical Engineers of Japan. Surge or noise superimposed on the power supply may damage internal components or cause them to malfunction. We recommend that you check the circuit waveform and use surge absorbers. The effects on components depend on the type of surge and noise that are generated. Always perform testing with the actual equipment.
- The Timer may be affected by incoming radio wave interference. Do not use the Timer near radio wave receivers.
- Do not use the Timer in circuits with waveform distortion. Error will be large due to waveform distortion.
- Do not install the Timer immediately next to heat sources.

## Wiring

### 1. Connecting Wires to the Push-In Plus Terminal Block Part Names of the Terminal Block

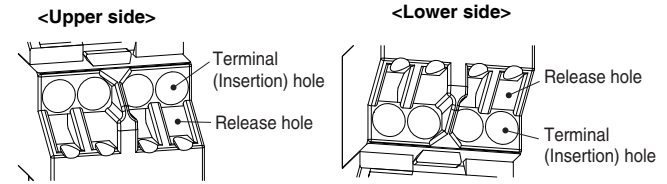

### Connecting Wires with Ferrules and Solid Wires

Insert the solid wire or ferrule straight into the terminal block until the end touches the terminal block.

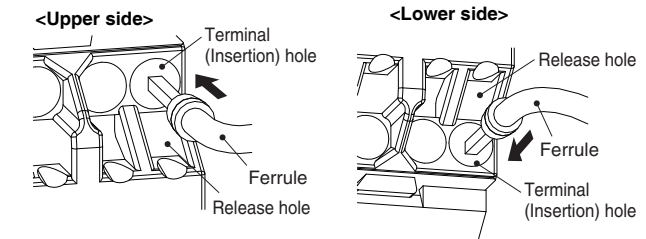

If a wire is difficult to connect because it is too thin, use a flat-blade screwdriver in the same way as when connecting stranded wire.

### Connecting Stranded Wires

Use the following procedure to connect the wires to the terminal block.

- Hold a flat-blade screwdriver at an angle and insert it into the release hole. The angle should be between  $10^\circ$  and  $15^\circ$ .  
If the flat-blade screwdriver is inserted correctly, you will feel the spring in the release hole respond.
- With the flat-blade screwdriver still inserted into the release hole, insert the wire into the terminal hole until it strikes the terminal block.
- Remove the flat-blade screwdriver from the release hole.

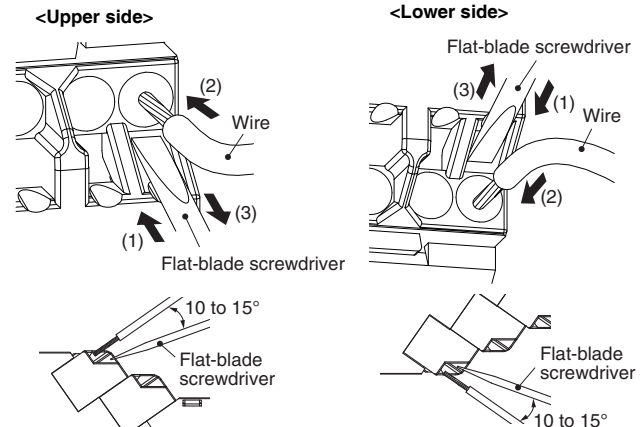

### Checking Connections

- After the insertion, pull gently on the wire to make sure that it will not come off and the wire is securely fastened to the terminal block.
- To prevent short circuits, insert the stripped part of a stranded or solid wire or the conductor part of a ferrule until it is hidden inside the terminal insertion hole. (See the following diagram.)

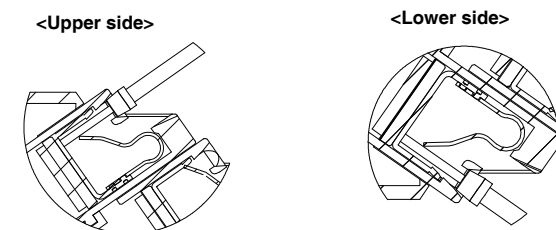



## 2. Removing Wires from the Push-In Plus Terminal Block

Use the following procedure to remove wires from the terminal block. The same method is used to remove stranded wires, solid wires, and ferrules.

1. Hold a flat-blade screwdriver at an angle and insert it into the release hole.
2. With the flat-blade screwdriver still inserted into the release hole, remove the wire from the terminal insertion hole.
3. Remove the flat-blade screwdriver from the release hole.

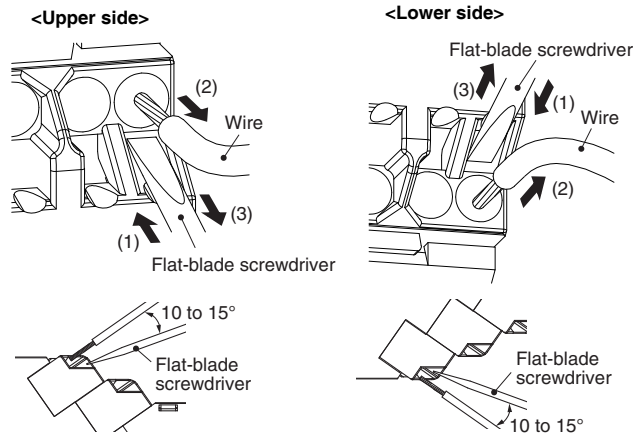

## Recommended Flat-blade Screwdriver

Use a flat-blade screwdriver to connect and remove wires. Use the flat-blade screwdriver from below the list.

The following table shows manufacturers and models as of 2015/Dec.

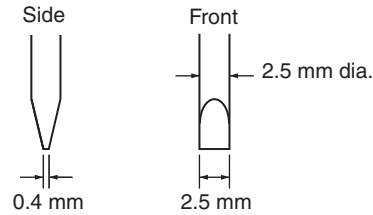

Model	Manufacturer
XW4Z-00B	Omron
ESD0.40X2.5	Wera
SZF 0.4X2.5	Phoenix Contact
0.4X2.5X75 302	Wiha
AEF.2.5X75	Facom
210-719	Wago
SDI 0.4X2.5X75	Weidmuller

If you wire crossovers and connect terminal blocks in parallel, a large current will flow. Make sure that the current does not exceed 10 A.

- Do not connect anything to unused terminals.
- Wire all terminals correctly.
- Check all wiring before you turn ON the power supply to the Timer.
- The H3DT-H acts like a high-impedance circuit. Therefore, the Timer may not reset if it is influenced by inductive voltage. To eliminate inductive voltage, the wires connected to the Timer must be as short as possible and should not be installed parallel to power lines. If the Timer is influenced by inductive voltage that is 30% or more of the rated voltage, connect a CR filter with a capacitance of approximately 0.1 μF and a resistance of approximately 120 Ω or a bleeder resistor between the power supply terminals.
- If there is any residual voltage due to current leakage, connect a bleeder resistor between the power supply terminals.

## 3. Recommended Ferrules and Tools

### Recommended ferrules

Wire		Ferrule length (mm)	Recommended ferrules		
(mm <sup>2</sup> )	(AWG)		Manufactured by Phoenix Contact	Manufactured by Weidmuller	Manufactured by Wago
0.25	24	8	AI0.25-8	H0.25/12	FE-0.25-8N-YE
0.34	22	8	AI0.34-8	H0.34/12	FE-0.34-8N-TQ
0.5	20	8	AI0.5-8	H0.5/14	FE-0.5-8N-WH
0.75	18	8	AI0.75-8	H0.75/14	FE-0.75-8N-GY
1	18	8	AI1-8	H1.0/14	FE-1.0-8N-RD
1.5	16	8	AI1.5-8	H1.5/14	FE-1.5-8N-BK
Recommended crimp tool			CRIMPFOX6 CRIMPFOX6-F CRIMPFOX10S	PZ6 roto	Variocrimp4

- Note:**
1. Make sure that the outer diameter of the wire coating is smaller than the inner diameter of the insulation sleeve of the recommended ferrule.
  2. Make sure that the ferrule processing dimensions conform to the following figures.

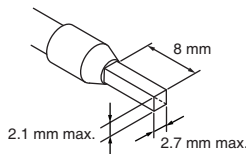

## Operating Frequency

- The H3DT-H may malfunction if it is used as shown below. Do not use the H3DT-H in these ways.  
Timer Repeatedly Times Out in Cycles of 3 s or Less



In the above case, use the H3DT-N/L in D mode (signal OFF delay).

- If you use Flicker Mode and set the dial on the H3DT-F to the minimum setting, the contacts may be damaged. Avoid this type of application.

## Options

- Use the Y92A-D1A for the Front Cover.
- If you use the Front Cover, make sure that it is attached securely.

## Other Precautions

- If the Timer is mounted on a control panel, dismount the Timer from the control panel before carrying out a voltage withstand test between the electric circuits and non-current-carrying metal parts of the Timer. (Otherwise, the internal circuits of the Timer may be damaged.)
- The H3DK-H uses a latching relay for the output. Shock, such as dropping the H3DK-H during shipment or handling, can cause the output contacts to reverse to the neutral position. Check the output status with a tester before using the H3DK-H.
- The life expectancy of the control output contacts is greatly affected by switching conditions. Always confirm operation using the actual conditions and equipment before using the Timer and make sure that the number of switching operations presents no problems in performance. If Timer application is continued after performance has deteriorated, insulation failure between circuits, burning of the control output relay, or other problem will eventually occur.
- If the power supply voltage is gradually increased, a power reset may occur or the Timer may time out. Use a switch, relay, or other device with contacts to apply the power supply voltage all at once.
- Make sure that residual voltage or inductive voltage is not applied after the power turns OFF.
- Error in the operation time of the Timer is given as a percentage of the full-scale time. The absolute value of the error will not change even if the set time is changed. Therefore, always use the Timer with the set time set as close as possible to the full-scale value of the set time range.
- When switching a microload, check the specified minimum load given for the Timer model you are using.
- When setting the operating time, do not turn the dial beyond the scale range.
- Store the Timer within the rated ranges given for the Timer model you are using. If the Timer is stored below  $-20^{\circ}\text{C}$ , allow it to warm up for three hours at room temperature before turning ON the power supply.
- Do not install the Timer in any way that would place a load on it.
- When cleaning the Timer, do not use thinners or solvents. Use commercial alcohol.
- If better accuracy is required in the set time, adjust the dial while measuring the operation time.
- Do not construct a circuit for the H3DT-H that would allow overcurrent and burning to occur if the NO, NC and SPDT contacts are short-circuited. Arcing may generate short-circuiting between contacts if there is short-circuiting because of conversion to the MBB contacts caused by asynchronous operation of the NO and NC contacts, the interval between the NO and NC contacts is small, or a large current is left open.
- If the Timer is reset immediately after timing out, make sure that the circuit configuration allows sufficient resetting time. Errors will occur in the sequence if there is not sufficient resetting time.
- When directly switching a DC load, the switching capacity will be lower than when switching an AC load.

## ⚠ EN/IEC Standard Compliance

- Refer to the datasheet for the H3DK for cable selection and other conditions for compliance with EMC standards.

### Precaution on EN Standard Compliance

The H3DT complies with EN 61812-1 when it is built into a panel, but observe the following handling methods to ensure compliance with the requirements of this standard.

### Wiring

Overvoltage category III

Pollution degree 2

- Open-frame Device
- If basic, double, or reinforced insulation is required, use the basic, double, or reinforced insulation defined in IEC 60664 that is suitable for the maximum applied voltage for the clearance, solid insulation, and other factors.
- The power supply terminals and input terminals are not isolated from each other.
- There is basic insulation between the power supply terminals and output terminals.
- There is basic insulation between the input terminals and output terminals.
- The operating section must have reinforced or double insulation.
- The sides of the case are not isolated.
- Connect the output contacts (contacts with different polarity) so that they reach the same potential.



### Recommended Replacement Periods and Periodic Replacement as Preventive Maintenance

The recommended replacement period for preventive maintenance is greatly influenced by the application environment of the product. As a guideline for models that do not have a Maintenance Forecast Monitor, the recommended replacement period is 7 to 10 years.\* To prevent failures that can be caused by using a product beyond its service life, we recommend that you replace the product as early as possible within the recommended replacement period. However, realize that the recommended replacement period is for reference only and does not guarantee the life of the product.

Many electronic components are used in the product and the product depends on the correct operation of these components to achieve product functions and performance. However, the influence of the ambient temperature on aluminum electrolytic capacitors is large, and the service life is reduced by half for each  $10^{\circ}\text{C}$  rise in temperature (Arrhenius law). When the capacity reduction life of the electrolytic capacitor is reached, the product may fail. We therefore recommend that you replace the product periodically to minimize product failures in advance.

\* The following conditions apply: rated input voltage, load rate of 50% max., ambient temperature of  $35^{\circ}\text{C}$  max., and the standalone mounting method.

This product model is designed with a service life of 10 years minimum under the above conditions.

# Terms and Conditions of Sale

1. **Offer; Acceptance.** These terms and conditions (these "**Terms**") are deemed part of all quotes, agreements, purchase orders, acknowledgments, price lists, catalogs, manuals, brochures and other documents, whether electronic or in writing, relating to the sale of products or services (collectively, the "**Products**") by Omron Electronics LLC and its subsidiary companies ("**Omron**"). Omron objects to any terms or conditions proposed in Buyer's purchase order or other documents which are inconsistent with, or in addition to, these Terms.
2. **Prices; Payment Terms.** All prices stated are current, subject to change without notice by Omron. Omron reserves the right to increase or decrease prices on any unshipped portions of outstanding orders. Payments for Products are due net 30 days unless otherwise stated in the invoice.
3. **Discounts.** Cash discounts, if any, will apply only on the net amount of invoices sent to Buyer after deducting transportation charges, taxes and duties, and will be allowed only if (i) the invoice is paid according to Omron's payment terms and (ii) Buyer has no past due amounts.
4. **Interest.** Omron, at its option, may charge Buyer 1-1/2% interest per month or the maximum legal rate, whichever is less, on any balance not paid within the stated terms.
5. **Orders.** Omron will accept no order less than \$200 net billing.
6. **Governmental Approvals.** Buyer shall be responsible for, and shall bear all costs involved in, obtaining any government approvals required for the importation or sale of the Products.
7. **Taxes.** All taxes, duties and other governmental charges (other than general real property and income taxes), including any interest or penalties thereon, imposed directly or indirectly on Omron or required to be collected directly or indirectly by Omron for the manufacture, production, sale, delivery, importation, consumption or use of the Products sold hereunder (including customs duties and sales, excise, use, turnover and license taxes) shall be charged to and remitted by Buyer to Omron.
8. **Financial.** If the financial position of Buyer at any time becomes unsatisfactory to Omron, Omron reserves the right to stop shipments or require satisfactory security or payment in advance. If Buyer fails to make payment or otherwise comply with these Terms or any related agreement, Omron may (without liability and in addition to other remedies) cancel any unshipped portion of Products sold hereunder and stop any Products in transit until Buyer pays all amounts, including amounts payable hereunder, whether or not then due, which are owing to it by Buyer. Buyer shall in any event remain liable for all unpaid accounts.
9. **Cancellation; Etc.** Orders are not subject to rescheduling or cancellation unless Buyer indemnifies Omron against all related costs or expenses.
10. **Force Majeure.** Omron shall not be liable for any delay or failure in delivery resulting from causes beyond its control, including earthquakes, fires, floods, strikes or other labor disputes, shortage of labor or materials, accidents to machinery, acts of sabotage, riots, delay in or lack of transportation or the requirements of any government authority.
11. **Shipping; Delivery.** Unless otherwise expressly agreed in writing by Omron:
  - a. Shipments shall be by a carrier selected by Omron; Omron will not drop ship except in "break down" situations.
  - b. Such carrier shall act as the agent of Buyer and delivery to such carrier shall constitute delivery to Buyer;
  - c. All sales and shipments of Products shall be FOB shipping point (unless otherwise stated in writing by Omron), at which point title and risk of loss shall pass from Omron to Buyer; provided that Omron shall retain a security interest in the Products until the full purchase price is paid;
  - d. Delivery and shipping dates are estimates only; and
  - e. Omron will package Products as it deems proper for protection against normal handling and extra charges apply to special conditions.
12. **Claims.** Any claim by Buyer against Omron for shortage or damage to the Products occurring before delivery to the carrier must be presented in writing to Omron within 30 days of receipt of shipment and include the original transportation bill signed by the carrier noting that the carrier received the Products from Omron in the condition claimed.
13. **Warranties.** (a) **Exclusive Warranty.** Omron's exclusive warranty is that the Products will be free from defects in materials and workmanship for a period of twelve months from the date of sale by Omron (or such other period expressed in writing by Omron). Omron disclaims all other warranties, express or implied. (b) **Limitations.** OMRON MAKES NO WARRANTY OR REPRESENTATION, EXPRESS OR IMPLIED, ABOUT NON-INFRINGEMENT, MERCHANTABILITY OR FITNESS FOR A PARTICULAR PURPOSE OF THE PRODUCTS. BUYER ACKNOWLEDGES THAT IT ALONE HAS DETERMINED THAT THE PRODUCTS WILL SUITABLY MEET THE REQUIREMENTS OF THEIR INTENDED USE. Omron further disclaims all warranties and responsibility of any type for claims or expenses based on infringement by the Products or otherwise of any intellectual property right. (c) **Buyer Remedy.** Omron's sole obligation hereunder shall be, at Omron's election, to (i) replace (in the form originally shipped with Buyer responsible for labor charges for removal or replacement thereof) the non-complying Product, (ii) repair the non-complying Product, or (iii) repay or credit Buyer an amount equal to the purchase price of the non-complying Product; provided that in no event shall Omron be responsible for warranty, repair, indemnity or any other claims or expenses regarding the Products unless Omron's analysis confirms that the Products were properly handled, stored, installed and maintained and not subject to contamination, abuse, misuse or inappropriate modification. Return of any Products by Buyer must be approved in writing by Omron before shipment. Omron Companies shall not be liable for the suitability or unsuitability or the results from the use of Products in combination with any electrical or electronic components, circuits, system assemblies or any other materials or substances or environments. Any advice, recommendations or information given orally or in writing, are not to be construed as an amendment or addition to the above warranty. See <http://www.omron247.com> or contact your Omron representative for published information.
14. **Limitation on Liability; Etc.** OMRON COMPANIES SHALL NOT BE LIABLE FOR SPECIAL, INDIRECT, INCIDENTAL, OR CONSEQUENTIAL DAMAGES, LOSS OF PROFITS OR PRODUCTION OR COMMERCIAL LOSS IN ANY WAY CONNECTED WITH THE PRODUCTS, WHETHER SUCH CLAIM IS BASED IN CONTRACT, WARRANTY, NEGLIGENCE OR STRICT LIABILITY. Further, in no event shall liability of Omron Companies exceed the individual price of the Product on which liability is asserted.
15. **Indemnities.** Buyer shall indemnify and hold harmless Omron Companies and their employees from and against all liabilities, losses, claims, costs and expenses (including attorney's fees and expenses) related to any claim, investigation, litigation or proceeding (whether or not Omron is a party) which arises or is alleged to arise from Buyer's acts or omissions under these Terms or in any way with respect to the Products. Without limiting the foregoing, Buyer (at its own expense) shall indemnify and hold harmless Omron and defend or settle any action brought against such Companies to the extent based on a claim that any Product made to Buyer specifications infringed intellectual property rights of another party.
16. **Property; Confidentiality.** Any intellectual property in the Products is the exclusive property of Omron Companies and Buyer shall not attempt to duplicate it in any way without the written permission of Omron. Notwithstanding any charges to Buyer for engineering or tooling, all engineering and tooling shall remain the exclusive property of Omron. All information and materials supplied by Omron to Buyer relating to the Products are confidential and proprietary, and Buyer shall limit distribution thereof to its trusted employees and strictly prevent disclosure to any third party.
17. **Export Controls.** Buyer shall comply with all applicable laws, regulations and licenses regarding (i) export of products or information; (ii) sale of products to "forbidden" or other proscribed persons; and (iii) disclosure to non-citizens of regulated technology or information.
18. **Miscellaneous.** (a) **Waiver.** No failure or delay by Omron in exercising any right and no course of dealing between Buyer and Omron shall operate as a waiver of rights by Omron. (b) **Assignment.** Buyer may not assign its rights hereunder without Omron's written consent. (c) **Law.** These Terms are governed by the law of the jurisdiction of the home office of the Omron company from which Buyer is purchasing the Products (without regard to conflict of law principles). (d) **Amendment.** These Terms constitute the entire agreement between Buyer and Omron relating to the Products, and no provision may be changed or waived unless in writing signed by the parties. (e) **Severability.** If any provision hereof is rendered ineffective or invalid, such provision shall not invalidate any other provision. (f) **Setoff.** Buyer shall have no right to set off any amounts against the amount owing in respect of this invoice. (g) **Definitions.** As used herein, "including" means "including without limitation"; and "Omron Companies" (or similar words) mean Omron Corporation and any direct or indirect subsidiary or affiliate thereof.

## Certain Precautions on Specifications and Use

1. **Suitability of Use.** Omron Companies shall not be responsible for conformity with any standards, codes or regulations which apply to the combination of the Product in the Buyer's application or use of the Product. At Buyer's request, Omron will provide applicable third party certification documents identifying ratings and limitations of use which apply to the Product. This information by itself is not sufficient for a complete determination of the suitability of the Product in combination with the end product, machine, system, or other application or use. Buyer shall be solely responsible for determining appropriateness of the particular Product with respect to Buyer's application, product or system. Buyer shall take application responsibility in all cases but the following is a non-exhaustive list of applications for which particular attention must be given: (i) Outdoor use, uses involving potential chemical contamination or electrical interference, or conditions or uses not described in this document. (ii) Use in consumer products or any use in significant quantities. (iii) Energy control systems, combustion systems, railroad systems, aviation systems, medical equipment, amusement machines, vehicles, safety equipment, and installations subject to separate industry or government regulations. (iv) Systems, machines and equipment that could present a risk to life or property. Please know and observe all prohibitions of use applicable to this Product. NEVER USE THE PRODUCT FOR AN APPLICATION INVOLVING SERIOUS RISK TO LIFE OR PROPERTY OR IN LARGE QUANTITIES WITHOUT ENSURING THAT THE SYSTEM AS A WHOLE HAS BEEN DESIGNED TO ADDRESS THE RISKS, AND THAT THE OMRON'S PRODUCT IS PROPERLY RATED AND INSTALLED FOR THE INTENDED USE WITHIN THE OVERALL EQUIPMENT OR SYSTEM.
2. **Programmable Products.** Omron Companies shall not be responsible for the user's programming of a programmable Product, or any consequence thereof.
3. **Performance Data.** Data presented in Omron Company websites, catalogs and other materials is provided as a guide for the user in determining suitability and does not constitute a warranty. It may represent the result of Omron's test conditions, and the user must correlate it to actual application requirements. Actual performance is subject to the Omron's Warranty and Limitations of Liability.
4. **Change in Specifications.** Product specifications and accessories may be changed at any time based on improvements and other reasons. It is our practice to change part numbers when published ratings or features are changed, or when significant construction changes are made. However, some specifications of the Product may be changed without any notice. When in doubt, special part numbers may be assigned to fix or establish key specifications for your application. Please consult with your Omron's representative at any time to confirm actual specifications of purchased Product.
5. **Errors and Omissions.** Information presented by Omron Companies has been checked and is believed to be accurate; however, no responsibility is assumed for clerical, typographical or proofreading errors or omissions.

**OMRON AUTOMATION AND SAFETY • THE AMERICAS HEADQUARTERS** • Chicago, IL USA • 847.843.7900 • 800.556.6766 • [www.omron247.com](http://www.omron247.com)

**OMRON CANADA, INC. • HEAD OFFICE**

Toronto, ON, Canada • 416.286.6465 • 866.986.6766 • [www.omron247.com](http://www.omron247.com)

**OMRON ELECTRONICS DE MEXICO • HEAD OFFICE**

México DF • 52.55.59.01.43.00 • 01-800-226-6766 • [mela@omron.com](mailto:mela@omron.com)

**OMRON ELECTRONICS DE MEXICO • SALES OFFICE**

Apodaca, N.L. • 52.81.11.56.99.20 • 01-800-226-6766 • [mela@omron.com](mailto:mela@omron.com)

**OMRON ELETRÔNICA DO BRASIL LTDA • HEAD OFFICE**

São Paulo, SP, Brasil • 55.11.2101.6300 • [www.omron.com.br](http://www.omron.com.br)

**OMRON ARGENTINA • SALES OFFICE**

Cono Sur • 54.11.4783.5300

**OMRON CHILE • SALES OFFICE**

Santiago • 56.9.9917.3920

**OTHER OMRON LATIN AMERICA SALES**

54.11.4783.5300

**OMRON EUROPE B.V.** • Wegalaan 67-69, NL-2132 JD, Hoofddorp, The Netherlands. • +31 (0) 23 568 13 00 • [www.industrial.omron.eu](http://www.industrial.omron.eu)

*Authorized Distributor:*

**Automation Control Systems**

- Machine Automation Controllers (MAC) • Programmable Controllers (PLC)
- Operator interfaces (HMI) • Distributed I/O • Software

**Drives & Motion Controls**

- Servo & AC Drives • Motion Controllers & Encoders

**Temperature & Process Controllers**

- Single and Multi-loop Controllers

**Sensors & Vision**

- Proximity Sensors • Photoelectric Sensors • Fiber-Optic Sensors
- Amplified Photomicrosensors • Measurement Sensors
- Ultrasonic Sensors • Vision Sensors

**Industrial Components**

- RFID/Code Readers • Relays • Pushbuttons & Indicators
- Limit and Basic Switches • Timers • Counters • Metering Devices
- Power Supplies

**Safety**

- Laser Scanners • Safety Mats • Edges and Bumpers • Programmable Safety Controllers • Light Curtains • Safety Relays • Safety Interlock Switches

Компания «Life Electronics» занимается поставками электронных компонентов импортного и отечественного производства от производителей и со складов крупных дистрибьюторов Европы, Америки и Азии.

С конца 2013 года компания активно расширяет линейку поставок компонентов по направлению коаксиальный кабель, кварцевые генераторы и конденсаторы (керамические, пленочные, электролитические), за счёт заключения дистрибьюторских договоров

Мы предлагаем:

- Конкурентоспособные цены и скидки постоянным клиентам.
- Специальные условия для постоянных клиентов.
- Подбор аналогов.
- Поставку компонентов в любых объемах, удовлетворяющих вашим потребностям.
- Приемлемые сроки поставки, возможна ускоренная поставка.
- Доставку товара в любую точку России и стран СНГ.
- Комплексную поставку.
- Работу по проектам и поставку образцов.
- Формирование склада под заказчика.
- Сертификаты соответствия на поставляемую продукцию (по желанию клиента).
- Тестирование поставляемой продукции.
- Поставку компонентов, требующих военную и космическую приемку.
- Входной контроль качества.
- Наличие сертификата ISO.

В составе нашей компании организован Конструкторский отдел, призванный помогать разработчикам, и инженерам.

Конструкторский отдел помогает осуществить:

- Регистрацию проекта у производителя компонентов.
- Техническую поддержку проекта.
- Защиту от снятия компонента с производства.
- Оценку стоимости проекта по компонентам.
- Изготовление тестовой платы монтаж и пусконаладочные работы.

