



Dual SPDT Analog Switches with Over-Rail Signal Handling

General Description

The MAX4850/MAX4850H/MAX4852/MAX4852H family of dual SPDT (single-pole/double-throw) switches operate from a single +2V to +5.5V supply and can handle signals greater than the supply rail. These switches feature low 3.5Ω or 3.5Ω/7Ω on-resistance with low on-capacitance, making them ideal for switching audio and data signals.

The MAX4850/MAX4850H are configured with two SPDT switches and feature two comparators for headphone detection or mute/send key functions. The MAX4852 has two SPDT switches with no comparators for low 1μA supply current.

For over-rail applications, these devices offer either the pass-through or high-impedance option. For the MAX4850/MAX4852, the signal (up to 5.5V) passes through the switch without distortion even when the positive supply rail is exceeded. For the MAX4850H/MAX4852H, the switch input becomes high impedance when the input signal exceeds the supply rail.

The MAX4850/MAX4850H/MAX4852/MAX4852H are available in the space-saving (3mm x 3mm), 16-pin TQFN package and operate over the extended temperature range of -40°C to +85°C.

Applications

- USB Switching
- Audio-Signal Routing
- Cellular Phones
- Notebook Computers
- PDA's and Other Handheld Devices

Features

- ◆ USB 2.0 Full Speed (12MB) and USB 1.1 Signal Switching Compliant
- ◆ Switch Signals Greater than V_{CC}
- ◆ 0.1ns Differential Skew
- ◆ 3.5Ω/7Ω On-Resistance
- ◆ 135MHz -3dB Bandwidth
- ◆ +2V to +5.5V Supply Range
- ◆ 1.8V Logic Compatible
- ◆ Low Supply Current
1μA (MAX4852)
5μA (MAX4850)
10μA (MAX4850H/MAX4852H)
- ◆ Available in a Space-Saving (3mm x 3mm), 16-Pin TQFN Package

Ordering Information

PART	TEMP RANGE	PIN-PACKAGE	TOP MARK
MAX4850ETE	-40°C to +85°C	16 TQFN-EP*	ABU
MAX4850HETE	-40°C to +85°C	16 TQFN-EP*	ABV
MAX4852ETE	-40°C to +85°C	16 TQFN-EP*	ABZ
MAX4852HETE	-40°C to +85°C	16 TQFN-EP*	ACA

*EP = Exposed paddle.

Pin Configurations and Selector Guide appear at end of data sheet.

Block Diagrams/Truth Table

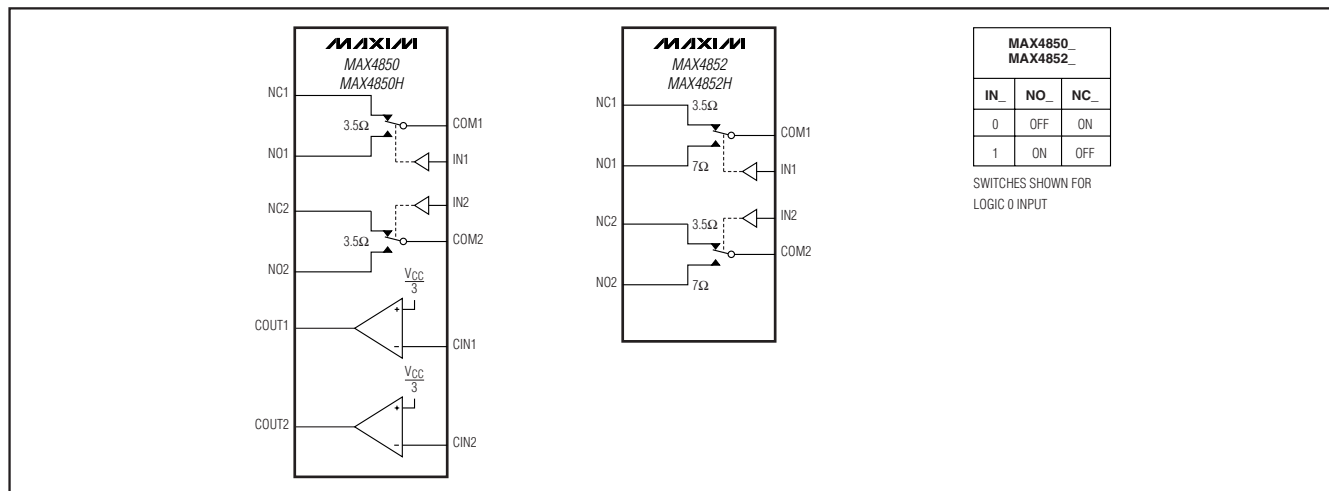

MAX4850/MAX4850H/MAX4852/MAX4852H

Dual SPDT Analog Switches with Over-Rail Signal Handling

ABSOLUTE MAXIMUM RATINGS

V_{CC} , IN_, CIN_, COM_, NO_, NC_ to GND (Note 1).....	-0.3V to +6.0V	Peak Current COM_, NO_, NC_ (pulsed at 1ms, 10% duty cycle)	
COUT_.....	-0.3V to (V_{CC} + 0.3V)	3.5 Ω Switch	\pm 240mA
COUT_ Continuous Current.....	\pm 20mA	7 Ω Switch	\pm 120mA
Closed Switch Continuous Current COM_, NO_, NC_		Continuous Power Dissipation (T_A = +70°C)	
3.5 Ω Switch	\pm 100mA	16-Pin TQFN (derate 20.8mW/°C above +70°C).....	1667mW
7 Ω Switch	\pm 50mA	Operating Temperature Range	-40°C to +85°C
Peak Current COM_, NO_, NC_ (pulsed at 1ms, 50% duty cycle)		Junction Temperature.....	+150°C
3.5 Ω Switch	\pm 200mA	Storage Temperature Range	-65°C to +150°C
7 Ω Switch	\pm 100mA	Lead Temperature (soldering, 10s).....	+300°C

Note 1: Signals on IN, NO, NC, or COM below GND are clamped by internal diodes. Limit forward-diode current to maximum current rating.

Stresses beyond those listed under "Absolute Maximum Ratings" may cause permanent damage to the device. These are stress ratings only, and functional operation of the device at these or any other conditions beyond those indicated in the operational sections of the specifications is not implied. Exposure to absolute maximum rating conditions for extended periods may affect device reliability.

ELECTRICAL CHARACTERISTICS

(V_{CC} = +2.7V to +5.5V, T_A = -40°C to +85°C, unless otherwise noted. Typical values are at V_{CC} = +3.0V, T_A = +25°C, unless otherwise noted.) (Note 2)

PARAMETER	SYMBOL	CONDITIONS	MIN	TYP	MAX	UNITS
Supply Voltage	V_{CC}		2.0		5.5	V
Supply Current	I_{CC}	$V_{CC} = 5.5V$, $V_{IN_1} = 0V$ or V_{CC}	MAX4850	5	10	μ A
			MAX4850H/ MAX4852H	10	20	
			MAX4852		1	
ANALOG SWITCH (3.5Ω Switch)						
Analog Signal Range	V_{NO_1} , V_{NC_1} , V_{COM_1}		0		5.5	V
On-Resistance (Note 3)	R_{ON}	$V_{CC} = 3V$, $I_{COM_1} = 10mA$, V_{NC_1} or $V_{NO_1} = 0$ to 5.5V (MAX485_) or V_{CC} (MAX485_H)	$T_A = +25^\circ C$	3.5	4.5	Ω
			$T_A = -40^\circ C$ to $+85^\circ C$		5	
On-Resistance Match Between Channels (Notes 3, 4)	ΔR_{ON}	$V_{CC} = 3V$, $I_{COM_1} = 10mA$, V_{NC_1} or $V_{NO_1} = 1.5V$	$T_A = +25^\circ C$	0.1	0.2	Ω
			$T_A = -40^\circ C$ to $+85^\circ C$		0.25	
On-Resistance Flatness (Note 5)	R_{FLAT}	$V_{CC} = 3V$, $I_{COM_1} = 10mA$, V_{NC_1} or $V_{NO_1} = 1V, 2V, 3V$	$T_A = +25^\circ C$	1.2	1.8	Ω
			$T_A = -40^\circ C$ to $+85^\circ C$		2	
NO_/NC_ Off-Leakage Current	I_{OFF}	$V_{CC} = 5.5V$, V_{NC_1} or $V_{NO_1} = 1V$ or 4.5V, $V_{COM_1} = 4.5V$ or 1V	$T_A = +25^\circ C$	-2	+2	nA
			$T_A = -40^\circ C$ to $+85^\circ C$	-10	+10	
COM_ On-Leakage Current	I_{ON}	$V_{CC} = 5.5V$; V_{NC_1} or $V_{NO_1} = 1V$, 4.5V, or floating; $V_{COM_1} = 1V, 4.5V$, or floating	$T_A = +25^\circ C$	-2	+2	nA
			$T_A = -40^\circ C$ to $+85^\circ C$	-12.5	+12.5	
-3dB Bandwidth	BW	Signal = 0dBm, $R_L = 50\Omega$, $C_L = 5pF$ (Figure 5)		100		MHz
NO_/NC_ Off-Capacitance	C_{OFF}	$f = 1MHz$ (Figure 6)		20		pF

Dual SPDT Analog Switches with Over-Rail Signal Handling

MAX4850/MAX4850H/MAX4852/MAX4852H

ELECTRICAL CHARACTERISTICS (continued)

($V_{CC} = +2.7V$ to $+5.5V$, $T_A = -40^\circ C$ to $+85^\circ C$, unless otherwise noted. Typical values are at $V_{CC} = +3.0V$, $T_A = +25^\circ C$, unless otherwise noted.) (Note 2)

PARAMETER	SYMBOL	CONDITIONS	MIN	TYP	MAX	UNITS
COM On-Capacitance	C_{ON}	$f = 1MHz$ (Figure 6)		60		pF
ANALOG SWITCH (7Ω Switch)						
Analog Signal Range	$V_{NO_}$, $V_{NC_}$, $V_{COM_}$		0		5.5	V
On-Resistance	R_{ON}	$V_{CC} = 3V$, $I_{COM_} = 10mA$, $V_{NC_}$ or $V_{NO_} = 0$ to $5.5V$ (MAX4852) or V_{CC} (MAX4852H)	$T_A = +25^\circ C$	7	9	Ω
			$T_A = -40^\circ C$ to $+85^\circ C$		10	
On-Resistance Match Between Channels (Notes 3, 4)	ΔR_{ON}	$V_{CC} = 3V$, $I_{COM_} = 10mA$, $V_{NC_}$ or $V_{NO_} = 1.5V$	$T_A = +25^\circ C$	0.2	0.4	Ω
			$T_A = -40^\circ C$ to $+85^\circ C$		0.5	
On-Resistance Flatness (Note 5)	R_{FLAT}	$V_{CC} = 3V$, $I_{COM_} = 10mA$, $V_{NC_}$ or $V_{NO_} = 1V, 2V, 3V$	$T_A = +25^\circ C$	2.5	3.75	Ω
			$T_A = -40^\circ C$ to $+85^\circ C$		4.0	
$NO_/NC_ Off$ -Leakage Current	I_{OFF}	$V_{CC} = 5.5V$, $V_{NC_}$ or $V_{NO_} = 1V$ or $4.5V$, $V_{COM_} = 4.5V$ or $1V$	$T_A = +25^\circ C$	-2	+2	nA
			$T_A = -40^\circ C$ to $+85^\circ C$	-10	+10	
$COM_ On$ -Leakage Current	I_{ON}	$V_{CC} = 5.5V$; $V_{NC_}$ or $V_{NO_} = 1V, 4.5V$, or floating; $V_{COM_} = 1V, 4.5V$, or floating	$T_A = +25^\circ C$	-2	+2	nA
			$T_A = -40^\circ C$ to $+85^\circ C$	-12.5	+12.5	
-3dB Bandwidth	BW	Signal = 0dBm, $R_L = 50\Omega$, $C_L = 5pF$ (Figure 5)		135		MHz
$NO_/NC_ Off$ -Capacitance	C_{OFF}	$f = 1MHz$ (Figure 6)		12		pF
COM On-Capacitance	C_{ON}	$f = 1MHz$ (Figure 6)		50		pF
DYNAMIC CHARACTERISTICS						
Signal Over-Rail to High-Z Switching Time	t_{HIZ}	MAX4850H/MAX4852H, $V_{NO_}$ or $V_{NC_} = V_{CC}$ to $(V_{CC} + 0.5V)$, $V_{CC} < 5V$ (Figure 1)		0.5	1	μs
High-Z to Low-Z Switching Time	t_{HIZB}	MAX4850H/MAX4852H, $V_{NO_}$ or $V_{NC_} = (V_{CC} + 0.5V)$ to V_{CC} , $V_{CC} < 5V$ (Figure 1)		0.5	1	μs
Skew (Note 3)	t_{SKEW}	$R_S = 39\Omega$, $C_L = 50pF$ (Figure 2)		0.1	1	ns
Propagation Delay (Note 3)	t_{PD}	$R_S = 39\Omega$, $C_L = 50pF$ (Figure 2)		0.9	2	ns
Turn-On Time	t_{ON}	$V_{CC} = 3V$, $V_{NO_}$ or $V_{NC_} = 1.5V$, $R_L = 300\Omega$, $C_L = 50pF$ (Figure 1)	$T_A = +25^\circ C$	40	60	ns
			$T_A = -40^\circ C$ to $+85^\circ C$		100	
Turn-Off Time	t_{OFF}	$V_{CC} = 3V$, $V_{NO_}$ or $V_{NC_} = 1.5V$, $R_L = 300\Omega$, $C_L = 50pF$ (Figure 1)	$T_A = +25^\circ C$	30	40	ns
			$T_A = -40^\circ C$ to $+85^\circ C$		60	

Dual SPDT Analog Switches with Over-Rail Signal Handling

ELECTRICAL CHARACTERISTICS (continued)

($V_{CC} = +2.7V$ to $+5.5V$, $T_A = -40^{\circ}C$ to $+85^{\circ}C$, unless otherwise noted. Typical values are at $V_{CC} = +3.0V$, $T_A = +25^{\circ}C$, unless otherwise noted.) (Note 2)

PARAMETER	SYMBOL	CONDITIONS	MIN	TYP	MAX	UNITS	
Break-Before-Make Time Delay (Note 3)	t_D	$V_{CC} = 3V$, $V_{NO_}$ or $V_{NC_} = 1.5V$, $R_L = 300\Omega$, $C_L = 50pF$ (Figure 3)	$T_A = +25^{\circ}C$	15		ns	
			$T_A = -40^{\circ}C$ to $+85^{\circ}C$	2			
Charge Injection	Q	$V_{COM_} = 1.5V$, $R_S = 0\Omega$, $C_L = 1nF$ (Figure 4)	8			pC	
Off-Isolation (Note 6)	V_{ISO}	$f = 100kHz$, $V_{COM_} = 1V_{RMS}$, $R_L = 50\Omega$, $C_L = 5pF$ (Figure 5)	-80			dB	
Crosstalk	V_{CT}	$f = 1MHz$, $V_{COM_} = 1V_{RMS}$, $R_L = 50\Omega$, $C_L = 5pF$ (Figure 5)	-95			dB	
Total Harmonic Distortion	THD	$f = 20Hz$ to $20kHz$, $V_{COM_} = 1V + 2V_{P-P}$, $R_L = 600\Omega$	0.04			%	
DIGITAL I/O (IN₋)							
Input-Logic High Voltage	V_{IH}	$V_{CC} = 2V$ to $3.6V$	1.4			V	
		$V_{CC} = 3.6V$ to $5.5V$	1.8				
Input-Logic Low Voltage	V_{IL}	$V_{CC} = 2V$ to $3.6V$			0.5	V	
		$V_{CC} = 3.6V$ to $5.5V$			0.8		
Input Leakage Current	I_{IN}	$V_{IN_} = 0$ or $5.5V$	-0.5			+0.5	μA
COMPARATOR							
Comparator Range			0	5.5		V	
Comparator Threshold	V_{TH}	$V_{CC} = 2V$ to $5.5V$, falling input	$0.3 \times V_{CC}$	$0.33 \times V_{CC}$	$0.36 \times V_{CC}$	V	
Comparator Hysteresis		$V_{CC} = 2V$ to $5.5V$	50			mV	
Comparator Output High Voltage		$I_{SOURCE} = 1mA$	$V_{CC} - 0.4V$			V	
Comparator Output Low Voltage		$I_{SINK} = 1mA$			0.4	V	
Comparator Switching Time		Rising input (Figure 7)	2.5			μs	
		Falling input (Figure 7)	0.5				

Note 2: Specifications are 100% tested at $T_A = +85^{\circ}C$ only, and guaranteed by design and characterization over the specified temperature range.

Note 3: Guaranteed by design and characterization; not production tested.

Note 4: $\Delta R_{ON} = R_{ON(MAX)} - R_{ON(MIN)}$.

Note 5: Flatness is defined as the difference between the maximum and minimum value of on-resistance as measured over the specified analog signal ranges.

Note 6: Off-isolation = $20\log_{10}(V_{COM_} / V_{NO_})$, $V_{COM_}$ = output, $V_{NO_}$ = input to off switch.

Dual SPDT Analog Switches with Over-Rail Signal Handling

Typical Operating Characteristics

($V_{CC} = 3.0V$, $T_A = +25^\circ C$, unless otherwise noted.)

MAX4850/MAX4850H/MAX4852/MAX4852H

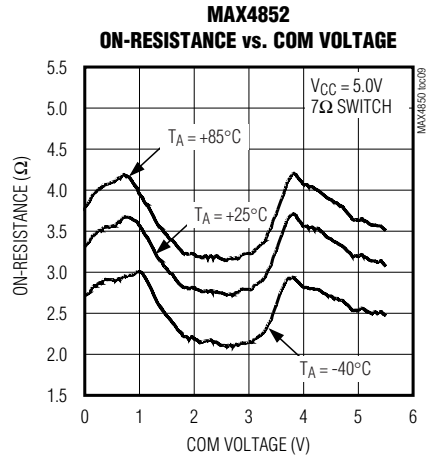
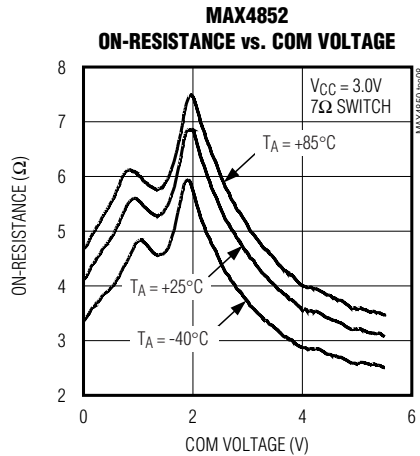
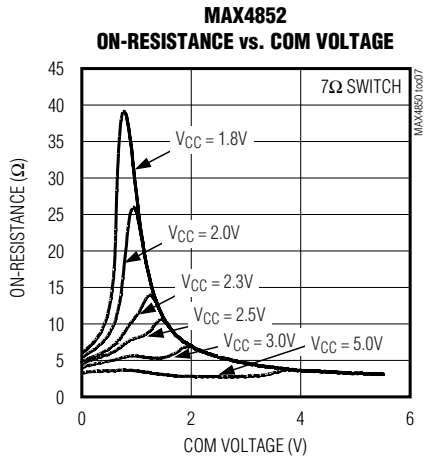
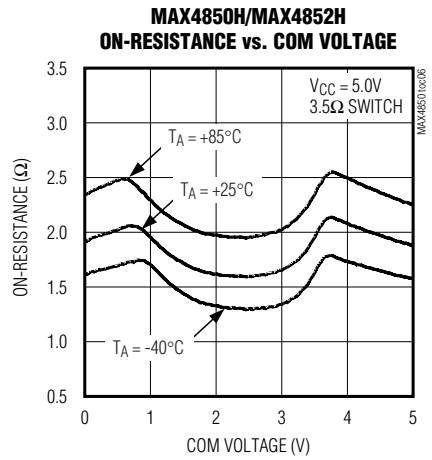
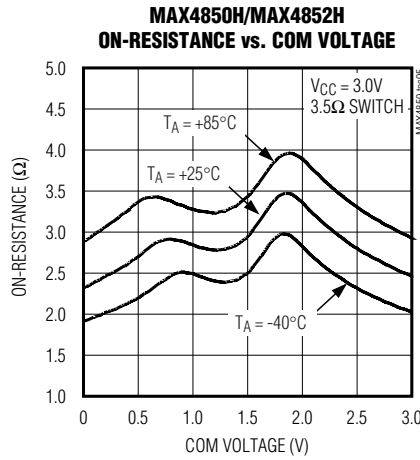
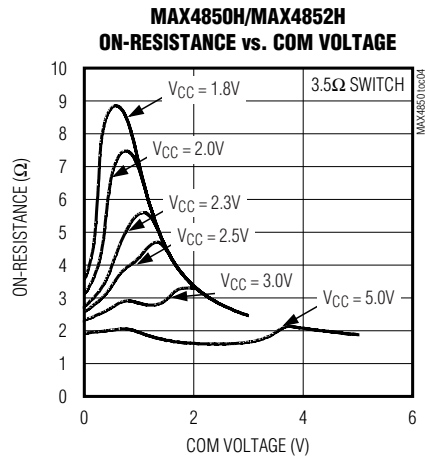
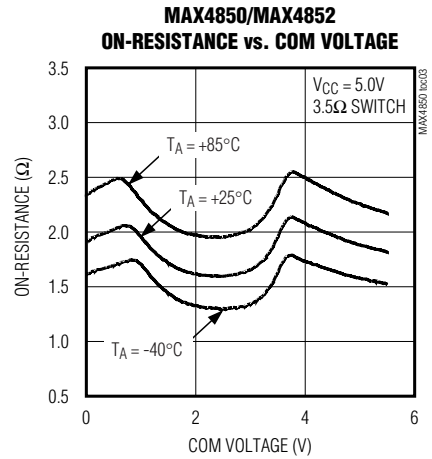
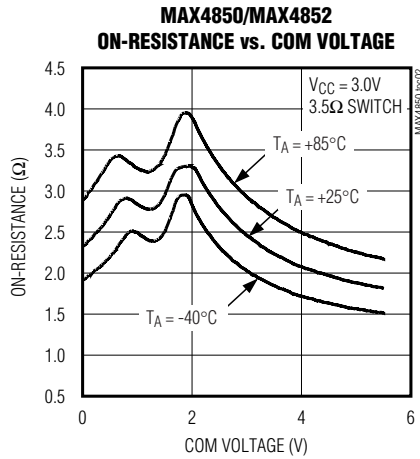
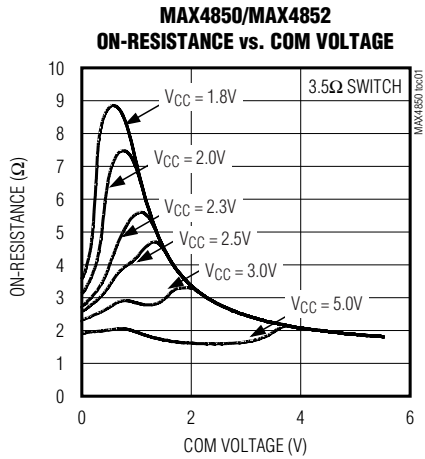

Dual SPDT Analog Switches with Over-Rail Signal Handling

Typical Operating Characteristics (continued)

($V_{CC} = 3.0V$, $T_A = +25^\circ C$, unless otherwise noted.)

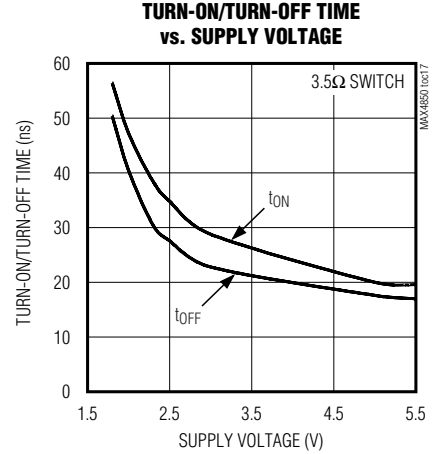
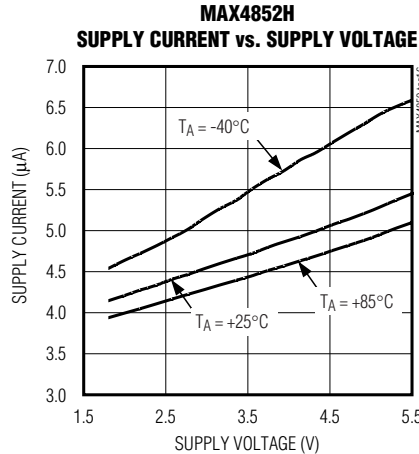
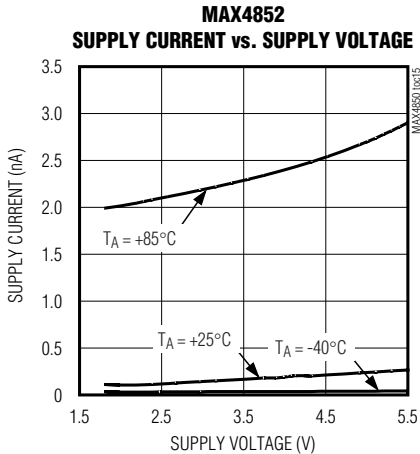
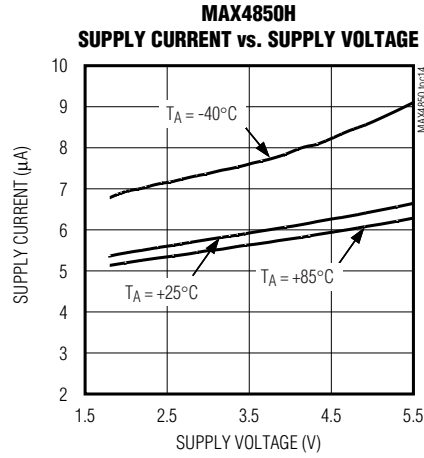
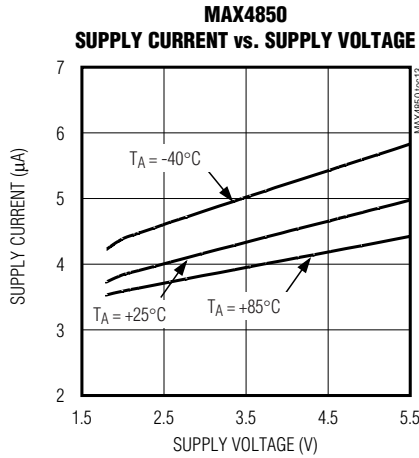
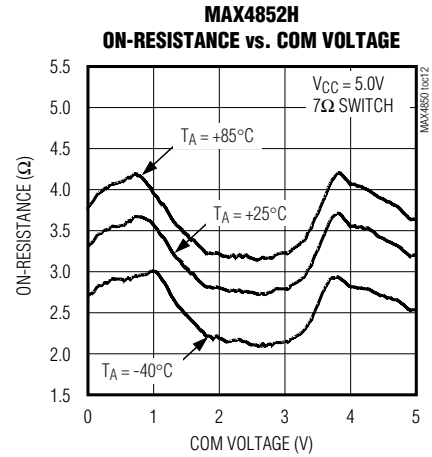
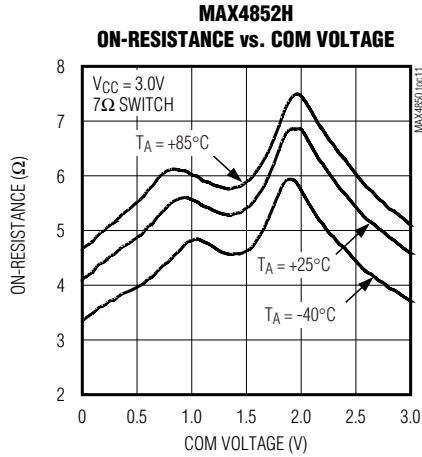
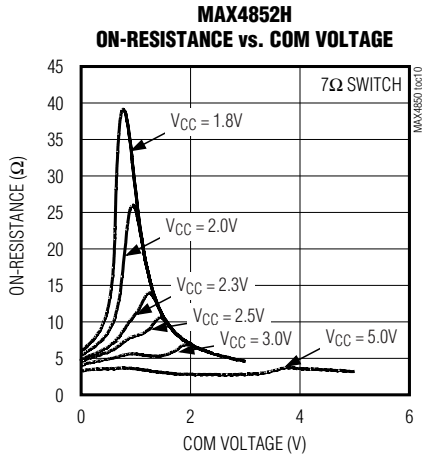

Dual SPDT Analog Switches with Over-Rail Signal Handling

Typical Operating Characteristics (continued)

($V_{CC} = 3.0V$, $T_A = +25^\circ C$, unless otherwise noted.)

MAX4850/MAX4850H/MAX4852/MAX4852H

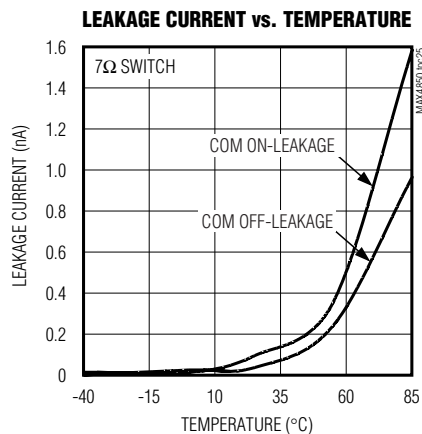
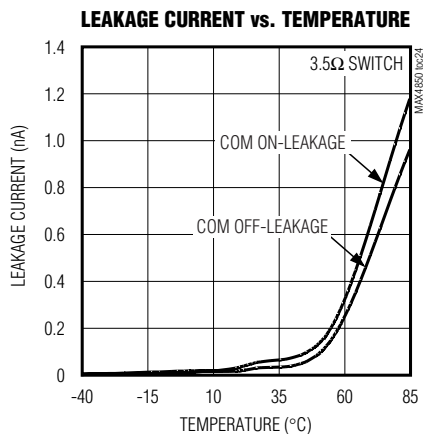
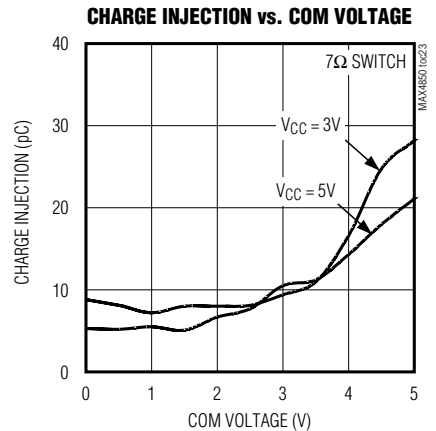
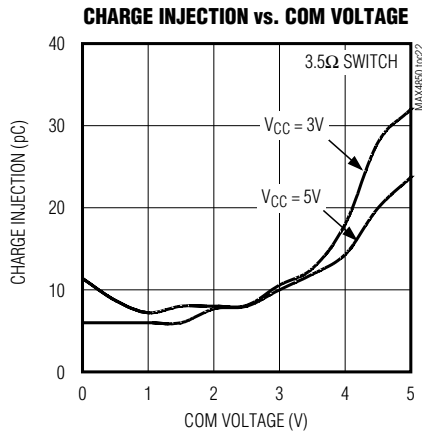
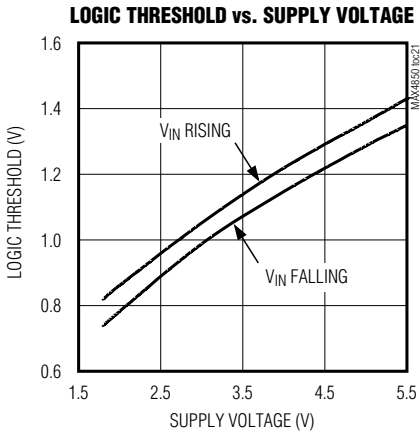
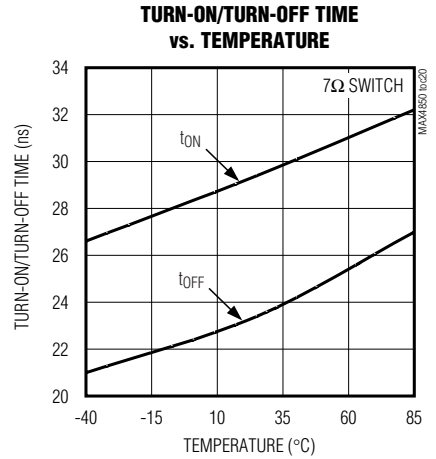
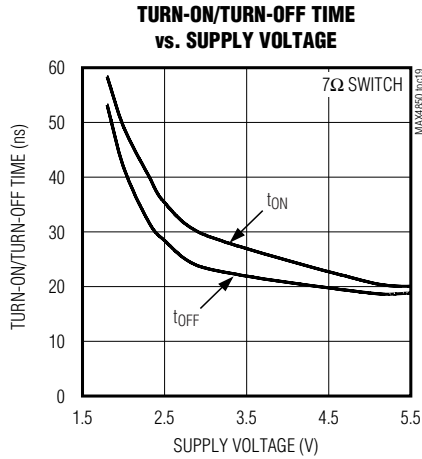
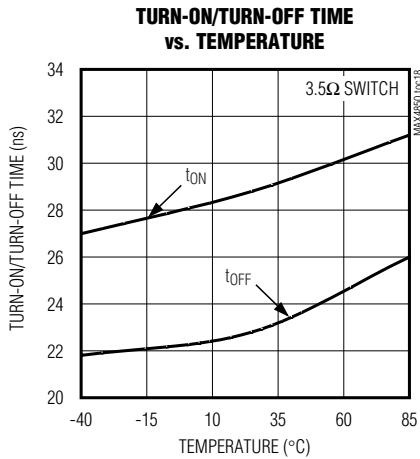

Dual SPDT Analog Switches with Over-Rail Signal Handling

Typical Operating Characteristics (continued)

($V_{CC} = 3.0V$, $T_A = +25^\circ C$, unless otherwise noted.)

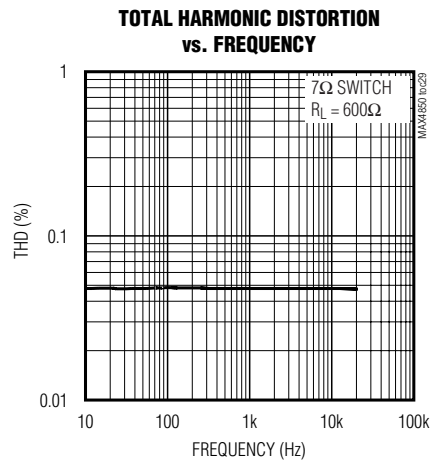
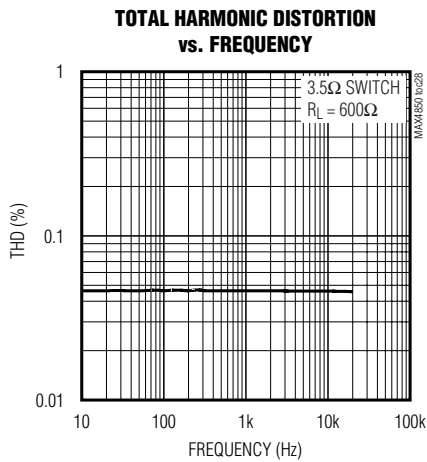
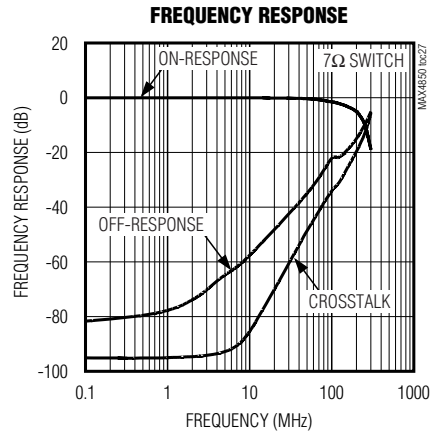
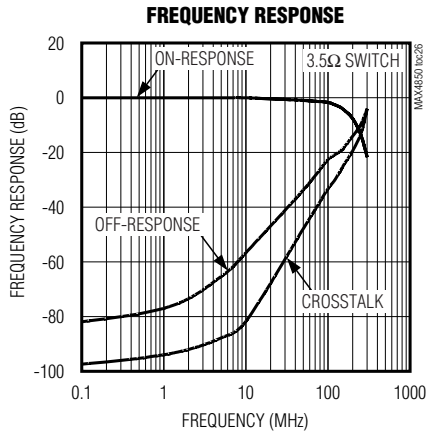

Dual SPDT Analog Switches with Over-Rail Signal Handling

Typical Operating Characteristics (continued)

($V_{CC} = 3.0V$, $T_A = +25^\circ C$, unless otherwise noted.)

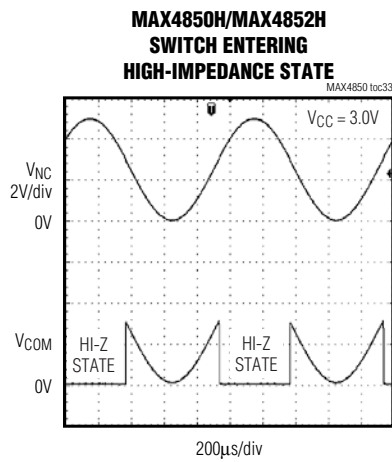
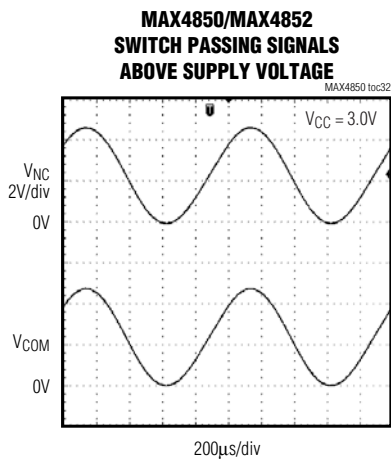
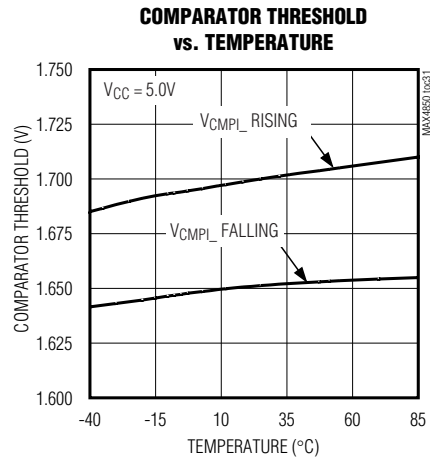
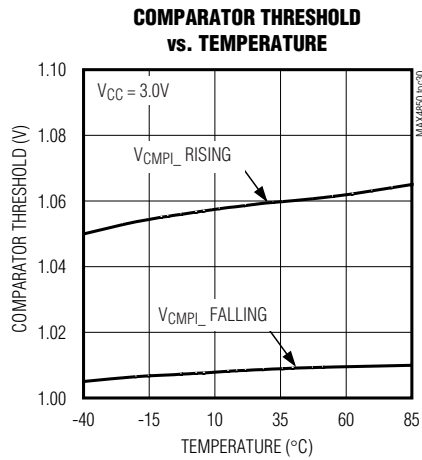

MAX4850/MAX4850H/MAX4852/MAX4852H

Dual SPDT Analog Switches with Over-Rail Signal Handling

Pin Descriptions

MAX4850/MAX4850H

PIN	NAME	FUNCTION
1, 8	N.C.	No Connection. Not internally connected.
2	CIN1	Inverting Input for Comparator 1
3	CIN2	Inverting Input for Comparator 2
4	COM1	Common Terminal for Analog Switch 1
5	NO1	Normally Open Terminal for Analog Switch 1
6	GND	Ground
7	NC2	Normally Closed Terminal for Analog Switch 2
9	IN2	Digital Control Input for Analog Switch 2. A logic LOW on IN2 connects COM2 to NC2 and a logic HIGH connects COM2 to NO2.
10	COM2	Common Terminal for Analog Switch 2
11	COU1	Output for Comparator 1
12	NO2	Normally Open Terminal for Analog Switch 2
13	COU2	Output for Comparator 2
14	V _{CC}	Supply Voltage. Bypass to GND with a 0.01μF capacitor as close to the pin as possible.
15	IN1	Digital Control Input for Analog Switch 1. A logic LOW on IN1 connects COM1 to NC1 and a logic HIGH connects COM1 to NO1.
16	NC1	Normally Closed Terminal for Analog Switch 1
EP	—	Exposed Paddle. Connect to PC board ground plane.

MAX4852/MAX4852H

PIN	NAME	FUNCTION
1, 2, 3, 8, 11, 13	N.C.	No Connection. Not internally connected.
4	COM1	Common Terminal for Analog Switch 1
5	NO1	Normally Open Terminal for Analog Switch 1
6	GND	Ground
7	NC2	Normally Closed Terminal for Analog Switch 2
9	IN2	Digital Control Input for Analog Switch 2. A logic LOW on IN2 connects COM2 to NC2 and a logic HIGH connects COM2 to NO2.
10	COM2	Common Terminal for Analog Switch 2
12	NO2	Normally Open Terminal for Analog Switch 2
14	V _{CC}	Supply Voltage. Bypass to GND with a 0.01μF capacitor as close to the pin as possible.
15	IN1	Digital Control Input for Analog Switch 1. A logic LOW on IN1 connects COM1 to NC1 and a logic HIGH connects COM1 to NO1.
16	NC1	Normally Closed Terminal for Analog Switch 1
EP	—	Exposed Paddle. Connect to PC board ground plane.

Dual SPDT Analog Switches with Over-Rail Signal Handling

Detailed Description

The MAX4850/MAX4850H/MAX4852/MAX4852H are low on-resistance, low-voltage, analog switches that operate from a +2V to +5.5V single supply and are fully specified for nominal 3.0V applications. These devices feature over-rail signal capability that allows signals up to 5.5V with supply voltages down to 2.0V. These devices are configured as dual SPDT switches.

These switches have low 50pF on-channel capacitance, which allows for 12Mbps switching of the data signals for USB 2.0 full speed/1.1 applications. The MAX485__ are designed to switch D+ and D- USB signals with a guaranteed skew of less than 1ns (see Figure 1), as measured from 50% of the input signal to 50% of the output signal.

The MAX4850_ feature a comparator that can be used for headphone or mute detection. The comparator threshold is internally generated to be approximately 1/3 of V_{CC} .

Applications Information

Digital Control Inputs

The logic inputs (IN_) accept up to +5.5V even if the supply voltages are below this level. For example, with a +3.3V V_{CC} supply, IN_ can be driven low to GND and high to +5.5V, allowing for mixing of logic levels in a system. Driving IN_ rail-to-rail minimizes power con-

sumption. For a +2V supply voltage, the logic thresholds are 0.5V (low) and 1.4V (high); for a +5V supply voltage, the logic thresholds are 0.8V (low) and 1.8V (high).

Analog Signal Levels

The on-resistance of these switches changes very little for analog input signals across the entire supply voltage range (see *Typical Operating Characteristics*). The switches are bidirectional, so NO_, NC_, and COM_ can be either inputs or outputs.

Comparator

The positive terminal of the comparator is internally set to $V_{CC}/3$. When the negative terminal (CIN_) is below the threshold ($V_{CC}/3$), the comparator output (COUT_) goes high. When CIN_ rises above $V_{CC}/3$, COUT_ goes low.

The comparator threshold allows for detection of headphones since headphone audio signals are typically biased to $V_{CC}/2$.

Power-Supply Sequencing

Caution: Do not exceed the absolute maximum ratings because stresses beyond the listed ratings may cause permanent damage to the device.

Proper power-supply sequencing is recommended for all CMOS devices. Always apply V_{CC} before applying analog signals, especially if the analog signal is not current-limited.

Dual SPDT Analog Switches with Over-Rail Signal Handling

Test Circuits/Timing Diagrams

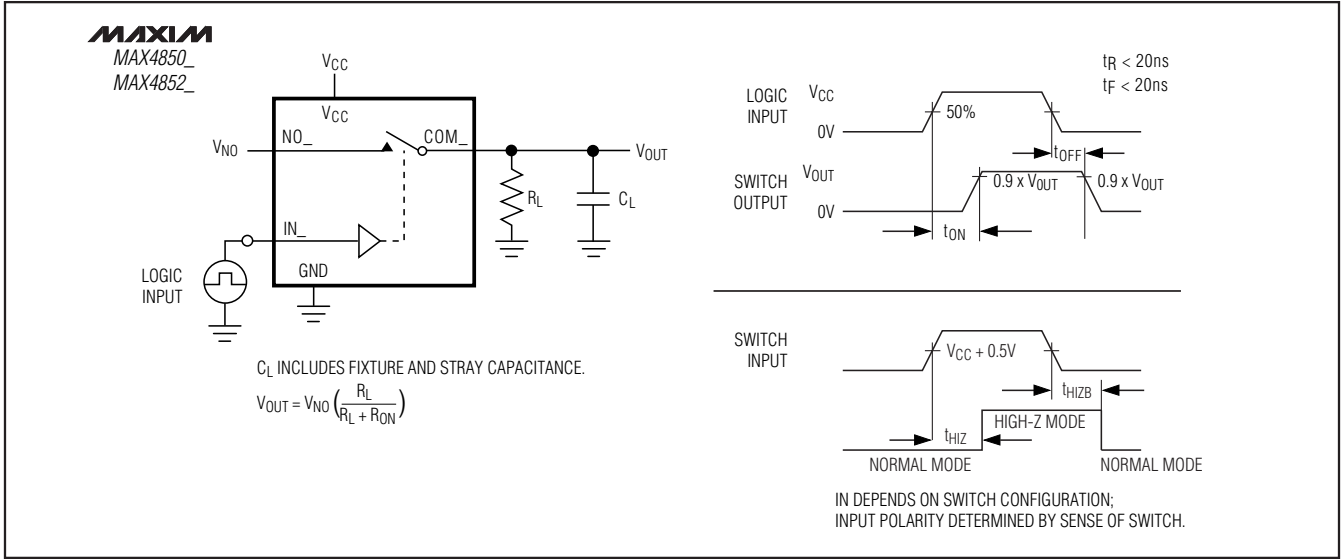

Figure 1. Switching Time

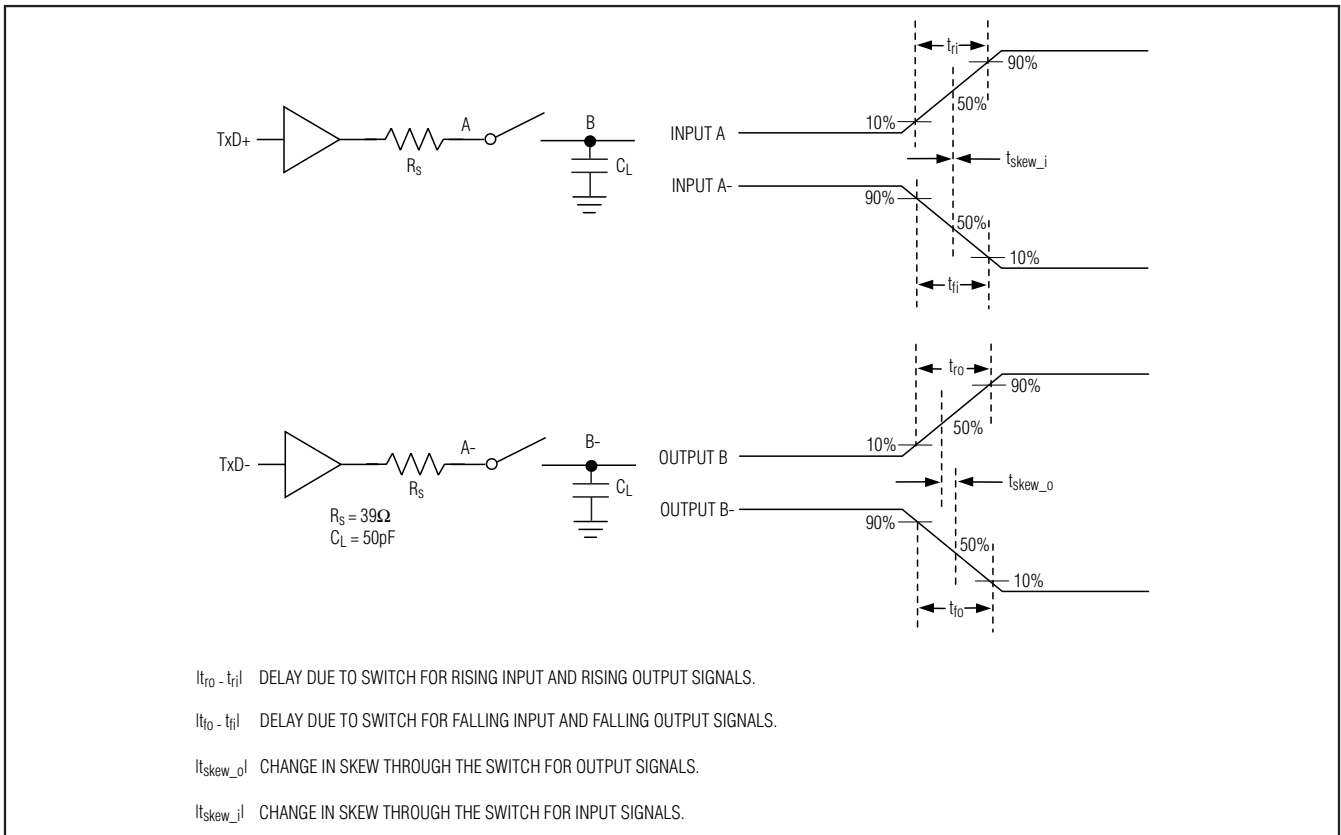

Figure 2. Input/Output Skew Timing Diagram

Dual SPDT Analog Switches with Over-Rail Signal Handling

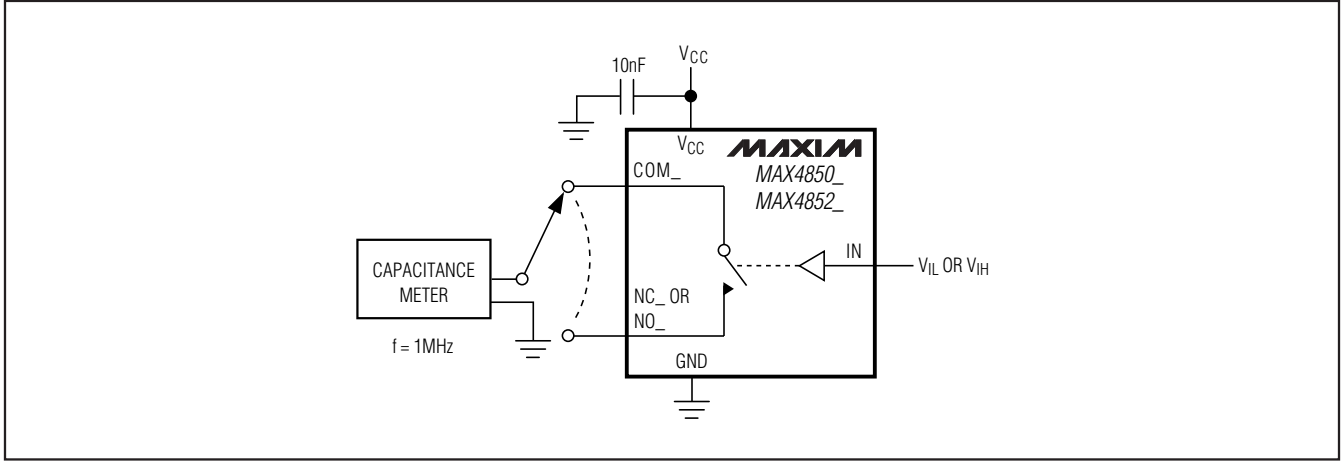

Figure 6. Channel Off-/On-Capacitance

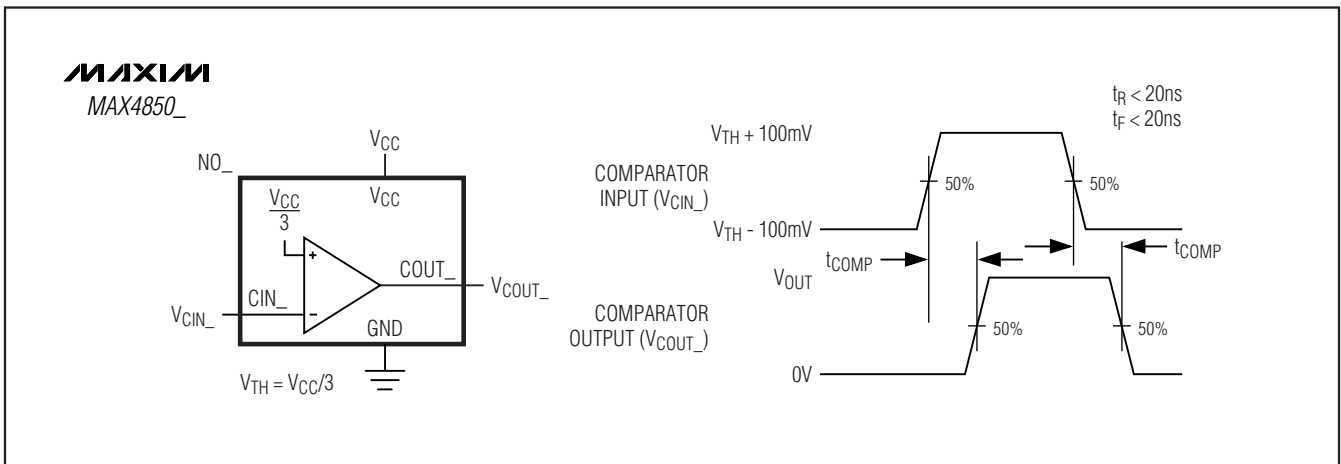
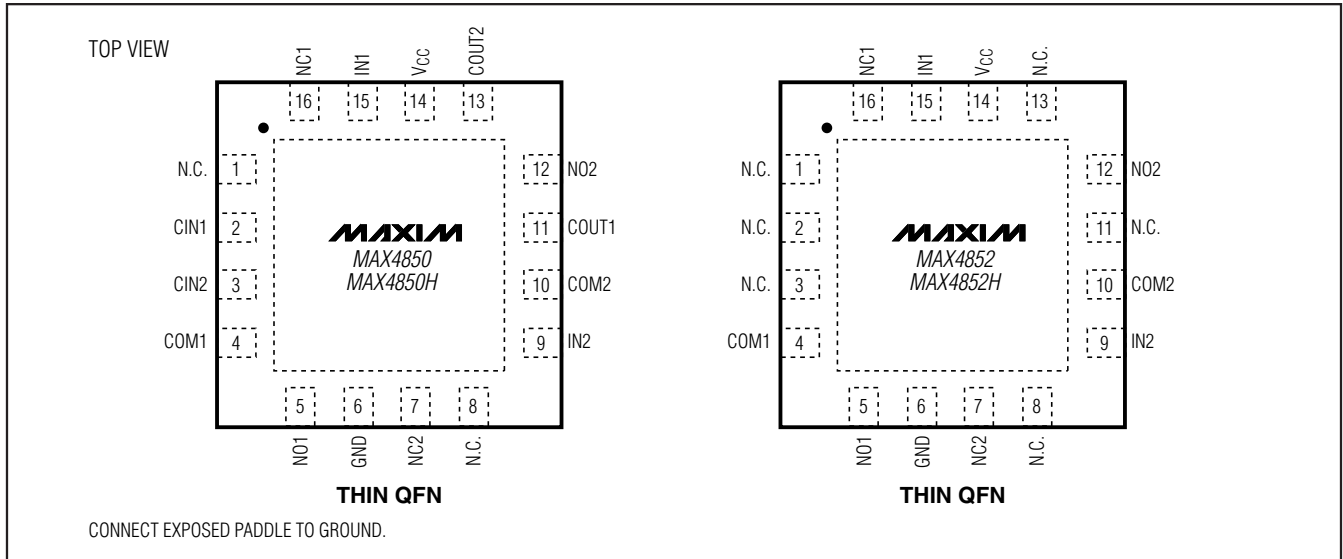

Figure 7. Comparator Switching Time

Dual SPDT Analog Switches with Over-Rail Signal Handling

Pin Configurations



Selector Guide

PART	R _{ON} NC_/NO_ (Ω)	COMPARATORS	OVER-RAIL HANDLING
MAX4850	3.5/3.5	2	Input signal passes through the switch
MAX4850H	3.5/3.5	2	High-impedance switch input
MAX4852	3.5/7	—	Input signal passes through the switch
MAX4852H	3.5/7	—	High-impedance switch input

Chip Information

TRANSISTOR COUNT: 735

PROCESS: CMOS

Typical Operating Circuit

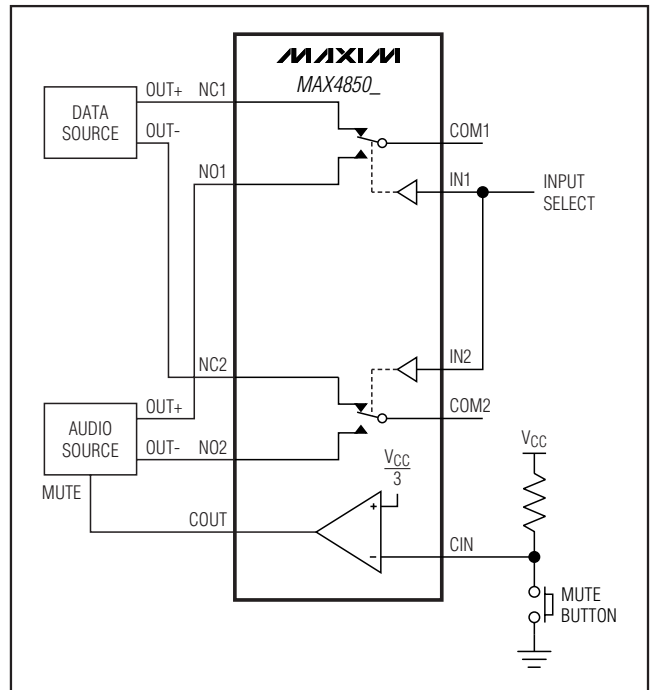

MAX4850/MAX4850H/MAX4852/MAX4852H

Dual SPDT Analog Switches with Over-Rail Signal Handling

Package Information

(The package drawing(s) in this data sheet may not reflect the most current specifications. For the latest package outline information go to www.maxim-ic.com/packages.)

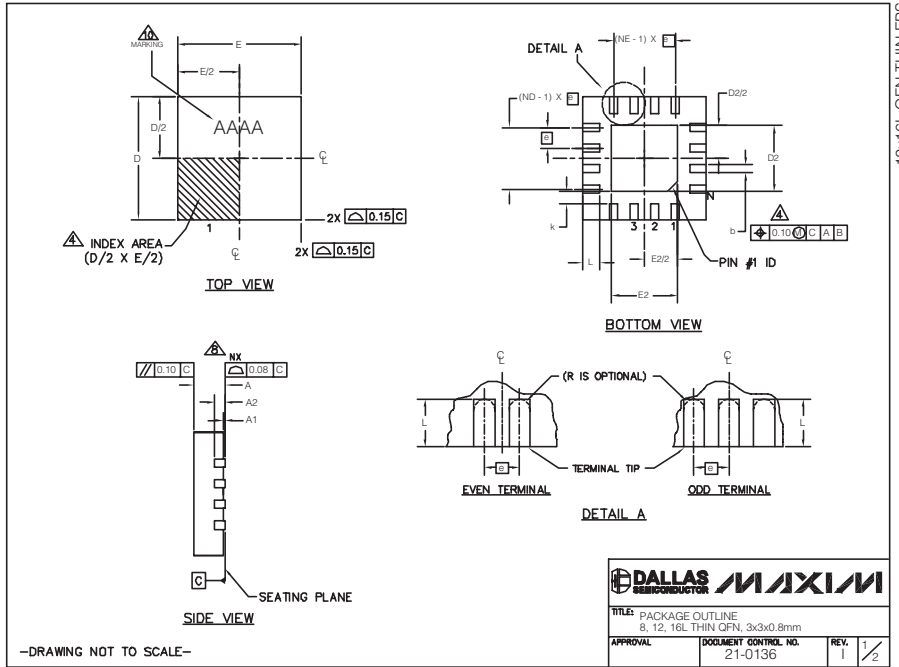

PKG	8L 3x3			12L 3x3			16L 3x3		
REF.	MIN.	NOM.	MAX.	MIN.	NOM.	MAX.	MIN.	NOM.	MAX.
A	0.70	0.75	0.80	0.70	0.75	0.80	0.70	0.75	0.80
b	0.25	0.30	0.35	0.20	0.25	0.30	0.20	0.25	0.30
D	2.90	3.00	3.10	2.90	3.00	3.10	2.90	3.00	3.10
E	2.90	3.00	3.10	2.90	3.00	3.10	2.90	3.00	3.10
e	0.65 BSC			0.50 BSC			0.50 BSC		
L	0.35	0.55	0.75	0.45	0.55	0.65	0.30	0.40	0.50
N	8			12			16		
ND	2			3			4		
NE	2			3			4		
A1	0	0.02	0.05	0	0.02	0.05	0	0.02	0.05
A2	0.20 REF			0.20 REF			0.20 REF		
k	0.25	-	-	0.25	-	-	0.25	-	-

PKG CODES	D2			E2			PIN ID	JEDEC
	MIN.	NOM.	MAX.	MIN.	NOM.	MAX.		
T0833-1	0.25	0.70	1.25	0.25	0.70	1.25	0.35 x 45°	WEEC
T1233-1	0.95	1.10	1.25	0.95	1.10	1.25	0.35 x 45°	WEED-1
T1233-3	0.95	1.10	1.25	0.95	1.10	1.25	0.35 x 45°	WEED-1
T1233-4	0.95	1.10	1.25	0.95	1.10	1.25	0.35 x 45°	WEED-1
T1633-2	0.95	1.10	1.25	0.95	1.10	1.25	0.35 x 45°	WEED-2
T1633F-3	0.65	0.80	0.95	0.65	0.80	0.95	0.225 x 45°	WEED-2
T1633FH-3	0.65	0.80	0.95	0.65	0.80	0.95	0.225 x 45°	WEED-2
T1633-4	0.95	1.10	1.25	0.95	1.10	1.25	0.35 x 45°	WEED-2
T1633-5	0.95	1.10	1.25	0.95	1.10	1.25	0.35 x 45°	WEED-2

NOTES:

- DIMENSIONING & TOLERANCING CONFORM TO ASME Y14.5M-1994.
- ALL DIMENSIONS ARE IN MILLIMETERS. ANGLES ARE IN DEGREES.
- N IS THE TOTAL NUMBER OF TERMINALS.
- THE TERMINAL #1 IDENTIFIER AND TERMINAL NUMBERING CONVENTION SHALL CONFORM TO JEDEC 95-1 SPP-012. DETAILS OF TERMINAL #1 IDENTIFIER ARE OPTIONAL, BUT MUST BE LOCATED WITHIN THE ZONE INDICATED. THE TERMINAL #1 IDENTIFIER MAY BE EITHER A MOLD OR MARKED FEATURE.
- DIMENSION b APPLIES TO METALLIZED TERMINAL AND IS MEASURED BETWEEN 0.20 mm AND 0.25 mm FROM TERMINAL TIP.
- ND AND NE REFER TO THE NUMBER OF TERMINALS ON EACH D AND E SIDE RESPECTIVELY.
- DEPOPULATION IS POSSIBLE IN A SYMMETRICAL FASHION.
- COPLANARITY APPLIES TO THE EXPOSED HEAT SINK SLUG AS WELL AS THE TERMINALS.
- DRAWING CONFORMS TO JEDEC MO220 REVISION C.
- MARKING IS FOR PACKAGE ORIENTATION REFERENCE ONLY.
- NUMBER OF LEADS SHOWN ARE FOR REFERENCE ONLY.
- WARPAGE NOT TO EXCEED 0.10mm.

-DRAWING NOT TO SCALE-

DALLAS SEMICONDUCTOR	MAXIM
TITLE: PACKAGE OUTLINE 8, 12, 16L THIN QFN, 3x3x0.8mm	
APPROVAL	DOCUMENT CONTROL NO. 21-0136
REV. 1	2/2

Maxim cannot assume responsibility for use of any circuitry other than circuitry entirely embodied in a Maxim product. No circuit patent licenses are implied. Maxim reserves the right to change the circuitry and specifications without notice at any time.

16 **Maxim Integrated Products, 120 San Gabriel Drive, Sunnyvale, CA 94086 408-737-7600**

Компания «Life Electronics» занимается поставками электронных компонентов импортного и отечественного производства от производителей и со складов крупных дистрибьюторов Европы, Америки и Азии.

С конца 2013 года компания активно расширяет линейку поставок компонентов по направлению коаксиальный кабель, кварцевые генераторы и конденсаторы (керамические, пленочные, электролитические), за счёт заключения дистрибьюторских договоров

Мы предлагаем:

- Конкуренеспособные цены и скидки постоянным клиентам.
- Специальные условия для постоянных клиентов.
- Подбор аналогов.
- Поставку компонентов в любых объемах, удовлетворяющих вашим потребностям.
- Приемлемые сроки поставки, возможна ускоренная поставка.
- Доставку товара в любую точку России и стран СНГ.
- Комплексную поставку.
- Работу по проектам и поставку образцов.
- Формирование склада под заказчика.
- Сертификаты соответствия на поставляемую продукцию (по желанию клиента).
- Тестирование поставляемой продукции.
- Поставку компонентов, требующих военную и космическую приемку.
- Входной контроль качества.
- Наличие сертификата ISO.

В составе нашей компании организован Конструкторский отдел, призванный помогать разработчикам, и инженерам.

Конструкторский отдел помогает осуществить:

- Регистрацию проекта у производителя компонентов.
- Техническую поддержку проекта.
- Защиту от снятия компонента с производства.
- Оценку стоимости проекта по компонентам.
- Изготовление тестовой платы монтаж и пусконаладочные работы.



Тел: +7 (812) 336 43 04 (многоканальный)

Email: org@lifeelectronics.ru