

## MMIC VCO w/ HALF FREQUENCY OUTPUT & DIVIDE-BY-4, 11.1 - 12.4 GHz



### Typical Applications

Low noise MMIC VCO w/Half Frequency, Divide-by-4 Outputs for:

- Point to Point/Multipoint Radio
- Test Equipment & Industrial Controls
- SATCOM
- Military End-Use

### Features

Triple Output: Fo = 11.1 - 12.4 GHz  
 Fo/2 = 5.55 - 6.2 GHz  
 Fo/4 = 2.78 - 3.1 GHz

Pout: +9 dBm

Phase Noise: -110 dBc/Hz @100 kHz Typ.

No External Resonator Needed

32 Lead 5x5mm SMT Package: 25mm<sup>2</sup>

### Functional Diagram

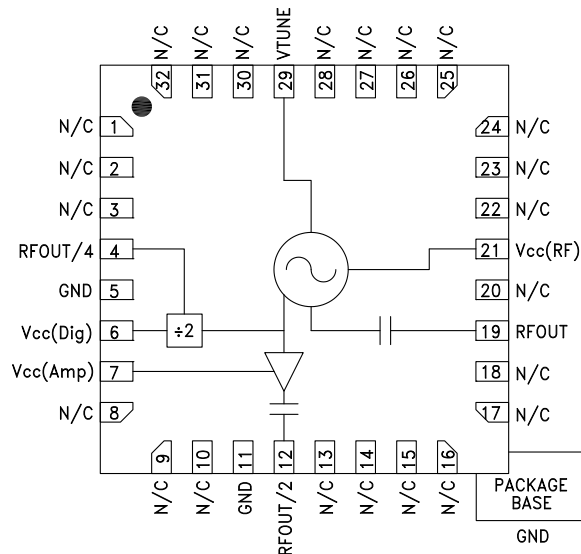

### General Description

The HMC582LP5 & HMC582LP5E are GaAs InGaP Heterojunction Bipolar Transistor (HBT) MMIC VCOs. The HMC582LP5 & HMC582LP5E integrate resonators, negative resistance devices, varactor diodes and feature half frequency and divide-by-4 outputs. The VCO's phase noise performance is excellent over temperature, shock, and process due to the oscillator's monolithic structure. Power output is +9 dBm typical from a +5V supply voltage. The prescaler and RF/2 functions can be disabled to conserve current if not required. The voltage controlled oscillator is packaged in a leadless QFN 5x5 mm surface mount package, and requires no external matching components.

### Electrical Specifications, T<sub>A</sub> = +25° C, Vcc (Dig), Vcc (Amp), Vcc (RF) = +5V

| Parameter  | Min.                          | Typ.        | Max. | Units  |    |
|--|-------------------------------|-------------|------|--------|----|
| Frequency Range                                      | Fo                            | 11.1 - 12.4 |      | GHz    |    |
|  | Fo/2                          | 5.55 - 6.2  |      | GHz    |    |
| Power Output   | RFOUT                         | +5          | +12  | dBm    |    |
|  | RFOUT/2                       | +8          | +14  | dBm    |    |
|  | RFOUT/4                       | -9          | -3   | dBm    |    |
| SSB Phase Noise @ 100 kHz Offset, Vtune= +5V @ RFOUT |                               | -110        |      | dBc/Hz |    |
| Tune Voltage   | Vtune                         | 2           | 12   | V      |    |
| Supply Current                                       | Icc(Dig) + Icc(Amp) + Icc(RF) | 290         | 350  | 390    | mA |
| Tune Port Leakage Current (Vtune= 13V)               |                               |             | 10   | µA     |    |
| Output Return Loss                                   |                               | 2           |      | dB     |    |
| Harmonics/Subharmonics                               | 1/2                           | 32          |      | dBc    |    |
|  | 2nd                           | 25          |      | dBc    |    |
|  | 3rd                           | 30          |      | dBc    |    |
| Pulling (into a 2.0:1 VSWR)                          |                               | 5           |      | MHz pp |    |
| Pushing @ Vtune= 5V                                  |                               | 30          |      | MHz/V  |    |
| Frequency Drift Rate                                 |                               | 1.2         |      | MHz/°C |    |

Information furnished by Analog Devices is believed to be accurate and reliable. However, no responsibility is assumed by Analog Devices for its use, nor for any infringements of patents or other rights of third parties that may result from its use. Specifications subject to change without notice. No license is granted by implication or otherwise under any patent or patent rights of Analog Devices. Trademarks and registered trademarks are the property of their respective owners.

For price, delivery, and to place orders: Analog Devices, Inc., One Technology Way, P.O. Box 9106, Norwood, MA 02062-9106  
 Phone: 781-329-4700 • Order online at [www.analog.com](http://www.analog.com)  
 Application Support: Phone: 1-800-ANALOG-D

**MMIC VCO w/ HALF FREQUENCY OUTPUT & DIVIDE-BY-4, 11.1 - 12.4 GHz**



**Frequency vs. Tuning Voltage, Vcc = +5V**

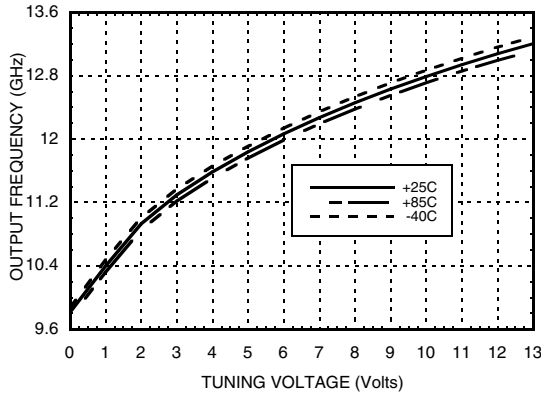

**Frequency vs. Tuning Voltage, T = 25°C**

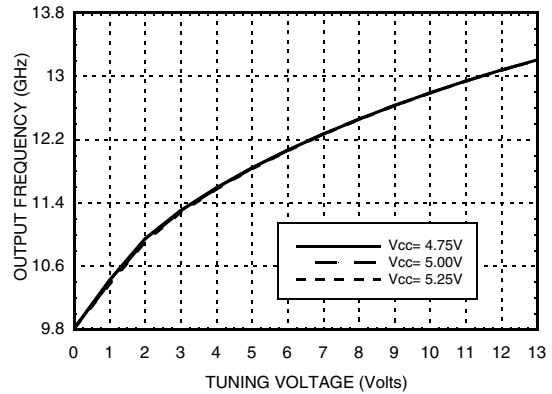

**Sensitivity vs. Tuning Voltage, Vcc = +5V**

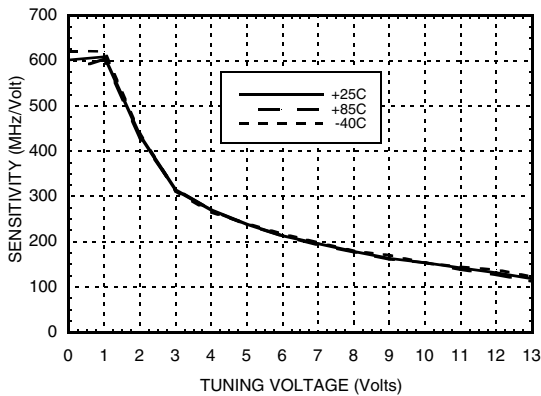

**Output Power vs. Tuning Voltage, Vcc = +5V**

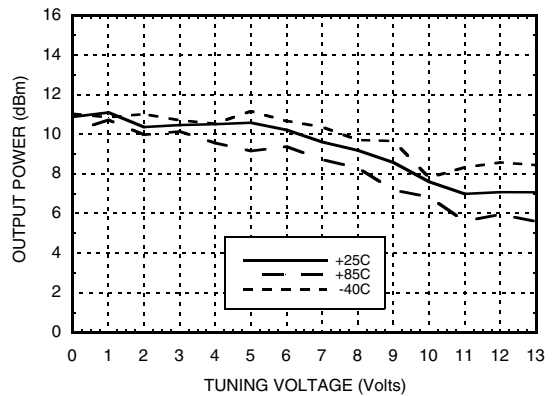

**SSB Phase Noise vs. Tuning Voltage**

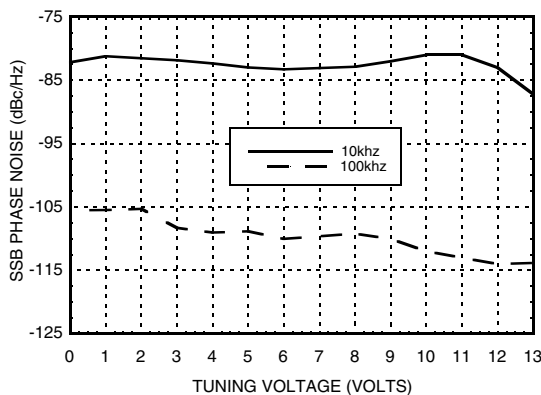

**SSB Phase Noise @ Vtune = +5V**

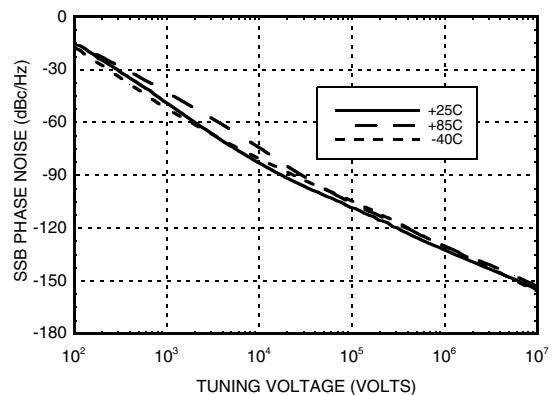

Information furnished by Analog Devices is believed to be accurate and reliable. However, no responsibility is assumed by Analog Devices for its use, nor for any infringements of patents or other rights of third parties that may result from its use. Specifications subject to change without notice. No license is granted by implication or otherwise under any patent or patent rights of Analog Devices. Trademarks and registered trademarks are the property of their respective owners.

For price, delivery, and to place orders: Analog Devices, Inc., One Technology Way, P.O. Box 9106, Norwood, MA 02062-9106 Phone: 781-329-4700 • Order online at [www.analog.com](http://www.analog.com) Application Support: Phone: 1-800-ANALOG-D

## MMIC VCO w/ HALF FREQUENCY OUTPUT & DIVIDE-BY-4, 11.1 - 12.4 GHz



**RFOUT/2 Frequency vs. Tuning Voltage, Vcc = +5V**

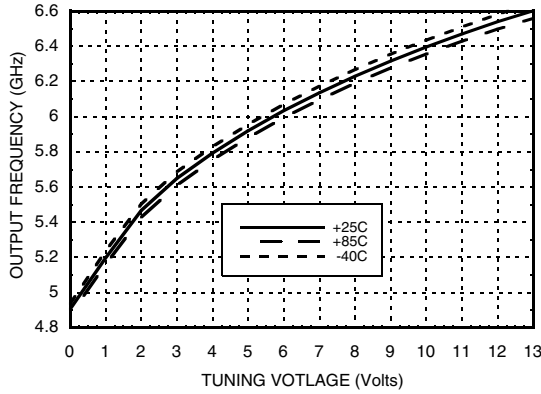

**RFOUT/2 Output Power vs. Tuning Voltage, Vcc = +5V**

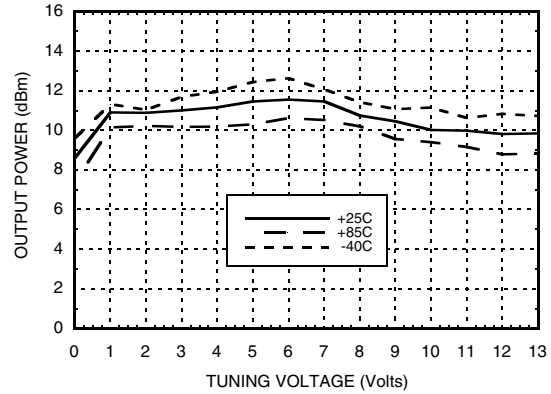

**Divide-by-4 Frequency vs. Tuning Voltage, Vcc = +5V**

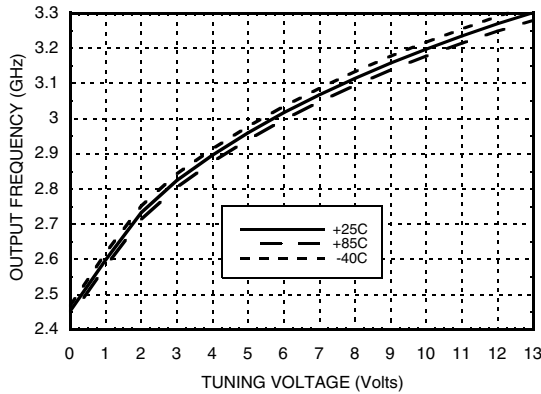

**Divide-by-4 Output Power vs. Tuning Voltage, Vcc = +5V**

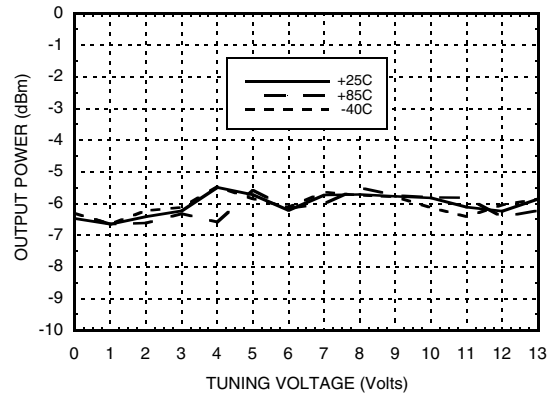

### Absolute Maximum Ratings

|  |                |
|--|----------------|
| Vcc(Dig), Vcc(Amp), Vcc(RF)  | +5.5 Vdc       |
| Vtune  | 0 to +15V      |
| Junction Temperature   | 135 °C         |
| Continuous P <sub>diss</sub> (T=85 °C)<br>(derate 43.5 mW/C above 85 °C) | 2.17 W         |
| Thermal Resistance<br>(junction to ground paddle)                        | 23 °C/W        |
| Storage Temperature  | -65 to +150 °C |
| Operating Temperature  | -40 to +85 °C  |
| ESD Sensitivity (HBM)  | Class 1A       |

### Typical Supply Current vs. Vcc

| Vcc (V) | I <sub>cc</sub> (mA) |
|---------|----------------------|
| 4.75    | 320                  |
| 5.00    | 350                  |
| 5.25    | 380                  |

Note: VCO will operate over full voltage range shown above.



**ELECTROSTATIC SENSITIVE DEVICE  
OBSERVE HANDLING PRECAUTIONS**

## MMIC VCO w/ HALF FREQUENCY OUTPUT & DIVIDE-BY-4, 11.1 - 12.4 GHz



### Outline Drawing

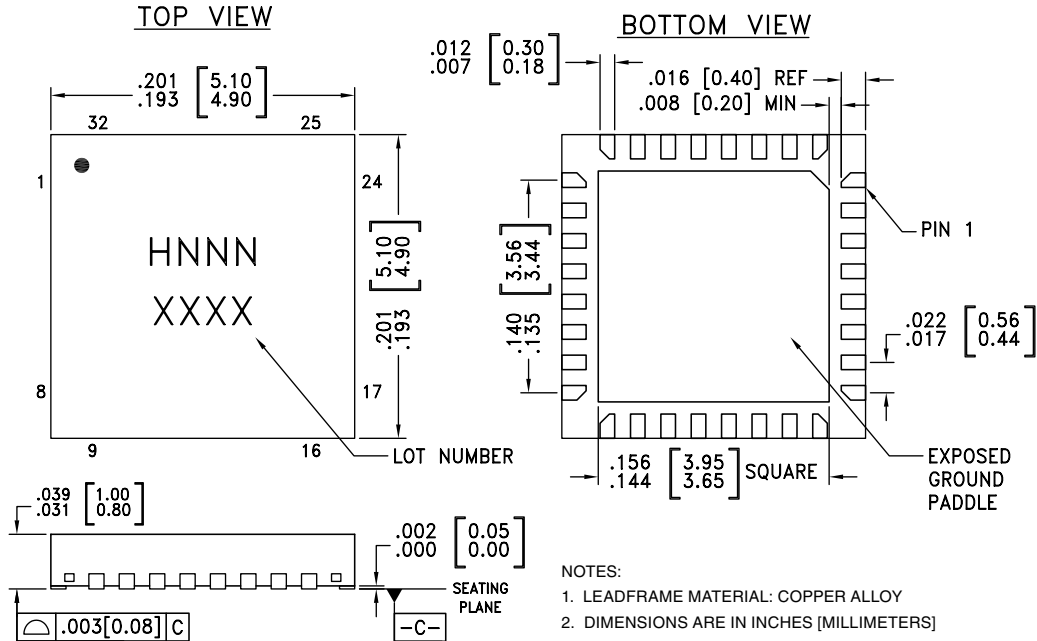

#### NOTES:

1. LEADFRAME MATERIAL: COPPER ALLOY
2. DIMENSIONS ARE IN INCHES [MILLIMETERS]
3. LEAD SPACING TOLERANCE IS NON-CUMULATIVE.
4. PAD BURR LENGTH SHALL BE 0.15mm MAXIMUM.  
PAD BURR HEIGHT SHALL BE 0.05mm MAXIMUM.
5. PACKAGE WARP SHALL NOT EXCEED 0.05mm.
6. ALL GROUND LEADS AND GROUND PADDLE MUST BE SOLDERED TO PCB RF GROUND.
7. REFER TO HITTITE APPLICATION NOTE FOR SUGGESTED LAND PATTERN.

### Package Information

| Part Number | Package Body Material                              | Lead Finish   | MSL Rating          | Package Marking <sup>[3]</sup> |
|-------------|--|---------------|---------------------|--------------------------------|
| HMC582LP5   | Low Stress Injection Molded Plastic                | Sn/Pb Solder  | MSL3 <sup>[1]</sup> | H582<br>XXXX                   |
| HMC582LP5E  | RoHS-compliant Low Stress Injection Molded Plastic | 100% matte Sn | MSL3 <sup>[2]</sup> | H582<br>XXXX                   |

[1] Max peak reflow temperature of 235 °C

[2] Max peak reflow temperature of 260 °C

[3] 4-Digit lot number XXXX

### Pin Descriptions

| Pin Number                                   | Function  | Description   | Interface Schematic |
|--|-----------|---|---------------------|
| 1 - 3, 8 - 10, 13 - 18, 20, 22 - 28, 30 - 32 | N/C       | No Connection. These pins may be connected to RF/DC ground. Performance will not be affected.                                     |                     |
| 4  | RFOUT/4   | Divide-by-4 output. DC block required.  |                     |
| 6  | Vcc (Dig) | Supply voltage for prescaler. If prescaler is not required, this pin may be left open to conserve approximately 65 mA of current. |                     |

Information furnished by Analog Devices is believed to be accurate and reliable. However, no responsibility is assumed by Analog Devices for its use, nor for any infringements of patents or other rights of third parties that may result from its use. Specifications subject to change without notice. No license is granted by implication or otherwise under any patent or patent rights of Analog Devices. Trademarks and registered trademarks are the property of their respective owners.

For price, delivery, and to place orders: Analog Devices, Inc., One Technology Way, P.O. Box 9106, Norwood, MA 02062-9106  
Phone: 781-329-4700 • Order online at [www.analog.com](http://www.analog.com)  
Application Support: Phone: 1-800-ANALOG-D

## MMIC VCO w/ HALF FREQUENCY OUTPUT & DIVIDE-BY-4, 11.1 - 12.4 GHz



### Pin Descriptions

| Pin Number    | Function  | Description   | Interface Schematic |
|---------------|-----------|---|---------------------|
| 7             | Vcc (Amp) | Supply voltage for RFOUT/2 output. If RFOUT/2 is not required, this pin may be left open to conserve approximately 30 mA of current.  |                     |
| 12            | RFOUT/2   | Half frequency output (AC coupled).   |                     |
| 19            | RF OUT    | RF output (AC coupled).   |                     |
| 21            | Vcc (RF)  | Supply Voltage, +5V   |                     |
| 29            | VTUNE     | Control voltage and modulation input. Modulation bandwidth dependent on drive source impedance. See "Determining the FM Bandwidth of a Wideband Varactor Tuned VCO" application note. |                     |
| 5, 11, Paddle | GND       | Package bottom has an exposed metal paddle that must be connected to RF/DC ground.  |                     |

### Typical Application Circuit

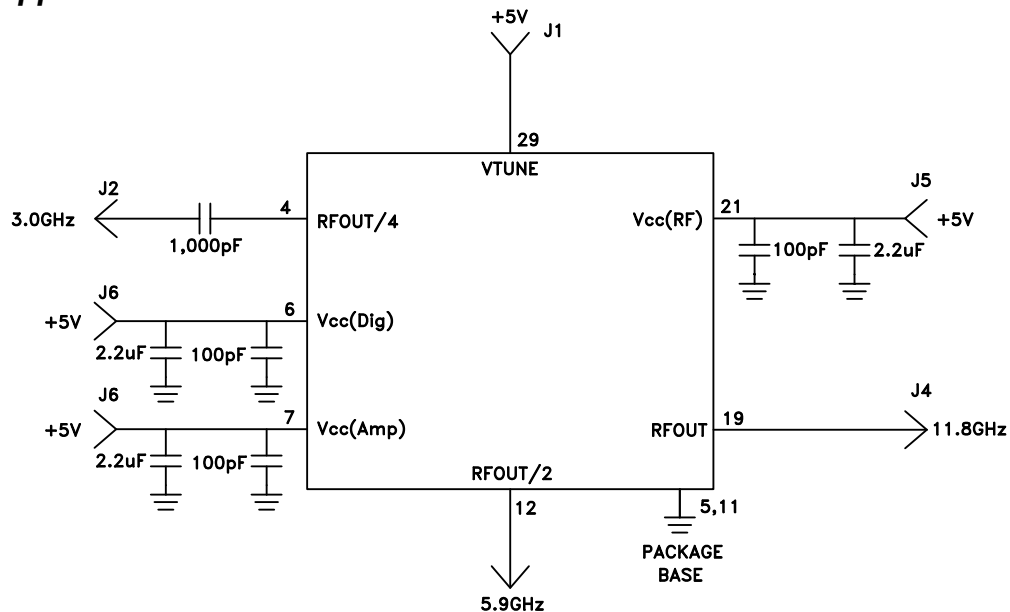

Information furnished by Analog Devices is believed to be accurate and reliable. However, no responsibility is assumed by Analog Devices for its use, nor for any infringements of patents or other rights of third parties that may result from its use. Specifications subject to change without notice. No license is granted by implication or otherwise under any patent or patent rights of Analog Devices. Trademarks and registered trademarks are the property of their respective owners.

For price, delivery, and to place orders: Analog Devices, Inc., One Technology Way, P.O. Box 9106, Norwood, MA 02062-9106  
 Phone: 781-329-4700 • Order online at [www.analog.com](http://www.analog.com)  
 Application Support: Phone: 1-800-ANALOG-D

**MMIC VCO w/ HALF FREQUENCY OUTPUT  
& DIVIDE-BY-4, 11.1 - 12.4 GHz**



**Evaluation PCB**

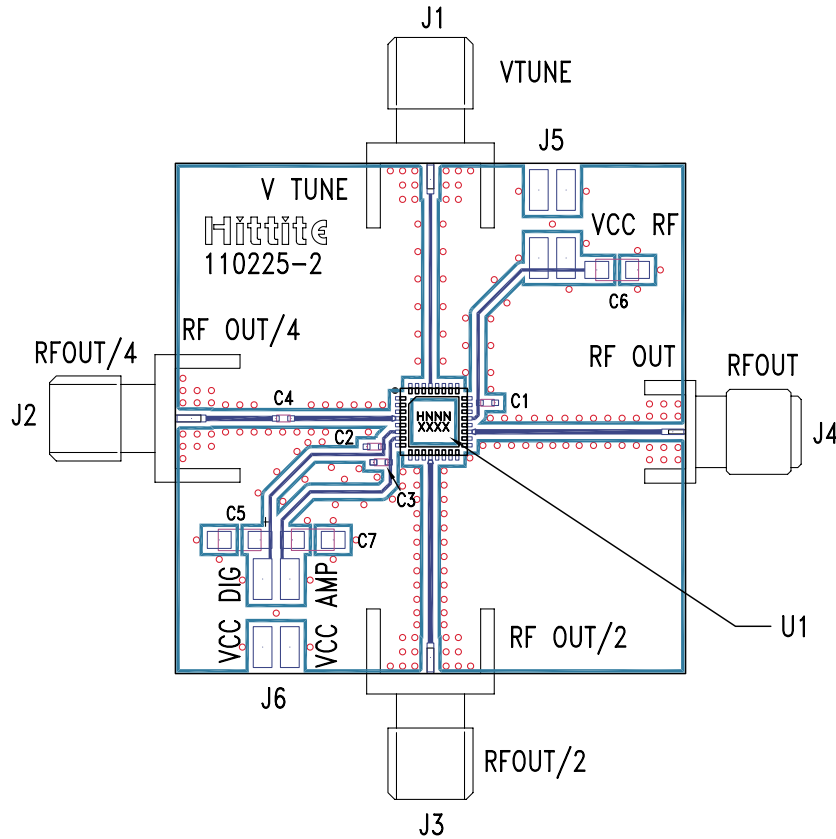

**List of Materials for Evaluation PCB 110227 [1]**

| Item    | Description                   |
|---------|-------------------------------|
| J1 - J4 | PCB Mount SMA RF Connector    |
| J5 - J6 | 2 mm DC Header                |
| C1 - C3 | 100 pF Capacitor, 0402 Pkg.   |
| C4      | 1,000 pF Capacitor, 0402 Pkg. |
| C5 - C7 | 2.2 μF Tantalum Capacitor     |
| U1      | HMC582LP5 / HMC582LP5E VCO    |
| PCB [2] | 110225 Eval Board             |

[1] Reference this number when ordering complete evaluation PCB

[2] Circuit Board Material: Rogers 4350

The circuit board used in the application should use RF circuit design techniques. Signal lines should have 50 Ohm impedance while the package ground leads and backside ground paddle should be connected directly to the ground plane similar to that shown. A sufficient number of via holes should be used to connect the top and bottom ground planes. The evaluation circuit board shown is available from Hittite upon request.

Компания «Life Electronics» занимается поставками электронных компонентов импортного и отечественного производства от производителей и со складов крупных дистрибьюторов Европы, Америки и Азии.

С конца 2013 года компания активно расширяет линейку поставок компонентов по направлению коаксиальный кабель, кварцевые генераторы и конденсаторы (керамические, пленочные, электролитические), за счёт заключения дистрибьюторских договоров

Мы предлагаем:

- Конкурентоспособные цены и скидки постоянным клиентам.
- Специальные условия для постоянных клиентов.
- Подбор аналогов.
- Поставку компонентов в любых объемах, удовлетворяющих вашим потребностям.
- Приемлемые сроки поставки, возможна ускоренная поставка.
- Доставку товара в любую точку России и стран СНГ.
- Комплексную поставку.
- Работу по проектам и поставку образцов.
- Формирование склада под заказчика.
- Сертификаты соответствия на поставляемую продукцию (по желанию клиента).
- Тестирование поставляемой продукции.
- Поставку компонентов, требующих военную и космическую приемку.
- Входной контроль качества.
- Наличие сертификата ISO.

В составе нашей компании организован Конструкторский отдел, призванный помогать разработчикам, и инженерам.

Конструкторский отдел помогает осуществить:

- Регистрацию проекта у производителя компонентов.
- Техническую поддержку проекта.
- Защиту от снятия компонента с производства.
- Оценку стоимости проекта по компонентам.
- Изготовление тестовой платы монтаж и пусконаладочные работы.



Тел: +7 (812) 336 43 04 (многоканальный)  
Email: [org@lifeelectronics.ru](mailto:org@lifeelectronics.ru)