



Precision, Very Low Noise, Low Input Bias Current, Wide Bandwidth JFET Operational Amplifiers

AD8610/AD8620

FEATURES

- Low noise: 6 nV/ $\sqrt{\text{Hz}}$
- Low offset voltage: 100 μV maximum
- Low input bias current: 10 pA maximum
- Fast settling: 600 ns to 0.01%
- Low distortion
- Unity gain stable
- No phase reversal
- Dual-supply operation: $\pm 5\text{ V}$ to $\pm 13\text{ V}$

APPLICATIONS

- Photodiode amplifiers
- ATE
- Instrumentation
- Sensors and controls
- High performance filters
- Fast precision integrators
- High performance audio

GENERAL DESCRIPTION

The AD8610/AD8620 are very high precision JFET input amplifiers featuring ultralow offset voltage and drift, very low input voltage and current noise, very low input bias current, and wide bandwidth. Unlike many JFET amplifiers, the AD8610/AD8620 input bias current is low over the entire operating temperature range. The AD8610/AD8620 are stable with capacitive loads of over 1000 pF in noninverting unity gain; much larger capacitive loads can be driven easily at higher noise gains. The AD8610/AD8620 swing to within 1.2 V of the supplies even with a 1 k Ω load, maximizing dynamic range even with limited supply voltages. Outputs slew at 50 V/ μs in either inverting or noninverting gain configurations, and settle to 0.01% accuracy in less than 600 ns. Combined with high input impedance, great precision, and very high output drive, the AD8610/AD8620 are ideal amplifiers for driving high performance ADC inputs and buffering DAC converter outputs.

PIN CONFIGURATIONS



Figure 1. 8-Lead MSOP and 8-Lead SOIC_N

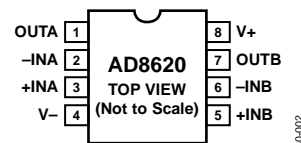

Figure 2. 8-Lead SOIC_N

Applications for the AD8610/AD8620 include electronic instruments; ATE amplification, buffering, and integrator circuits; CAT/MRI/ultrasound medical instrumentation; instrumentation quality photodiode amplification; fast precision filters (including PLL filters); and high quality audio.

The AD8610/AD8620 are fully specified over the extended industrial temperature range (-40°C to $+125^{\circ}\text{C}$). The AD8610 is available in the narrow 8-lead SOIC and the tiny 8-lead MSOP surface-mount packages. The AD8620 is available in the narrow 8-lead SOIC package. The 8-lead MSOP packaged devices are available only in tape and reel.

Rev. F

Information furnished by Analog Devices is believed to be accurate and reliable. However, no responsibility is assumed by Analog Devices for its use, nor for any infringements of patents or other rights of third parties that may result from its use. Specifications subject to change without notice. No license is granted by implication or otherwise under any patent or patent rights of Analog Devices. Trademarks and registered trademarks are the property of their respective owners.

TABLE OF CONTENTS

Features	1
Applications.....	1
Pin Configurations	1
General Description	1
Revision History	2
Specifications.....	3
Electrical Specifications.....	4

REVISION HISTORY

5/08—Rev. E to Rev. F

Changes to Figure 17.....	8
Changes to Functional Description Section	13
Changes to THD Readings vs. Common-Mode Voltage Section.....	17
Changes to Output Current Capability Section	18
Changes to Figure 66 and Figure 67.....	19
Changes to Figure 68.....	20
Replaced Second-Order Low-Pass Filter Section.....	20

11/06—Rev. D to Rev. E

Updated Format.....	Universal
Changes to Table 1.....	3
Changes to Table 2.....	4
Changes to Outline Dimensions.....	21
Changes to Ordering Guide	21

2/04—Rev. C to Rev. D.

Absolute Maximum Ratings	5
ESD Caution.....	5
Typical Performance Characteristics	6
Theory of Operation	13
Functional Description.....	13
Outline Dimensions	22
Ordering Guide	22

Changes to Specifications.....	2
Changes to Ordering Guide	4
Updated Outline Dimensions.....	17

10/02—Rev. B to Rev. C.

Updated Ordering Guide	4
Edits to Figure 15.....	12
Updated Outline Dimensions.....	16

5/02—Rev. A to Rev. B

Addition of Part Number AD8620.....	Universal
Addition of 8-Lead SOIC (R-8 Suffix) Drawing.....	1
Changes to General Description	1
Additions to Specifications	2
Change to Electrical Specifications.....	3
Additions to Ordering Guide.....	4
Replace TPC 29.....	8
Add Channel Separation Test Circuit Figure.....	9
Add Channel Separation Graph	9
Changes to Figure 26.....	15
Addition of High-Speed, Low Noise Differential Driver section	16
Addition of Figure 30.....	16

SPECIFICATIONS

@ $V_S = \pm 5.0$ V, $V_{CM} = 0$ V, $T_A = 25^\circ\text{C}$, unless otherwise noted.

Table 1.

Parameter	Symbol	Conditions	Min	Typ	Max	Unit
INPUT CHARACTERISTICS						
Offset Voltage (AD8610B)	V_{OS}	$-40^\circ\text{C} < T_A < +125^\circ\text{C}$		45 80	100 200	μV μV
Offset Voltage (AD8620B)	V_{OS}	$-40^\circ\text{C} < T_A < +125^\circ\text{C}$		45 80	150 300	μV μV
Offset Voltage (AD8610A/AD8620A)	V_{OS}	$25^\circ\text{C} < T_A < 125^\circ\text{C}$ $-40^\circ\text{C} < T_A < +125^\circ\text{C}$		85 90 150	250 350 850	μV μV μV
Input Bias Current	I_B	$-40^\circ\text{C} < T_A < +85^\circ\text{C}$ $-40^\circ\text{C} < T_A < +125^\circ\text{C}$	-10 -250	+2 +130	+10 +250	pA pA
Input Offset Current	I_{OS}	$-40^\circ\text{C} < T_A < +85^\circ\text{C}$ $-40^\circ\text{C} < T_A < +125^\circ\text{C}$	-2.5 -10 -75 -150	+1.5 +1 +20 +40	+2.5 +10 +75 +150	nA pA pA pA
Input Voltage Range			-2		+3	V
Common-Mode Rejection Ratio	CMRR	$V_{CM} = -1.5$ V to $+2.5$ V	90	95		dB
Large Signal Voltage Gain	A_{VO}	$R_L = 1$ k Ω , $V_O = -3$ V to $+3$ V	100	180		V/mV
Offset Voltage Drift (AD8610B)	$\Delta V_{OS}/\Delta T$	$-40^\circ\text{C} < T_A < +125^\circ\text{C}$		0.5	1	$\mu\text{V}/^\circ\text{C}$
Offset Voltage Drift (AD8620B)	$\Delta V_{OS}/\Delta T$	$-40^\circ\text{C} < T_A < +125^\circ\text{C}$		0.5	1.5	$\mu\text{V}/^\circ\text{C}$
Offset Voltage Drift (AD8610A/AD8620A)	$\Delta V_{OS}/\Delta T$	$-40^\circ\text{C} < T_A < +125^\circ\text{C}$		0.8	3.5	$\mu\text{V}/^\circ\text{C}$
OUTPUT CHARACTERISTICS						
Output Voltage High	V_{OH}	$R_L = 1$ k Ω , $-40^\circ\text{C} < T_A < +125^\circ\text{C}$	3.8	4		V
Output Voltage Low	V_{OL}	$R_L = 1$ k Ω , $-40^\circ\text{C} < T_A < +125^\circ\text{C}$		-4	-3.8	V
Output Current	I_{OUT}	$V_{OUT} > \pm 2$ V		± 30		mA
POWER SUPPLY						
Power Supply Rejection Ratio	PSRR	$V_S = \pm 5$ V to ± 13 V	100	110		dB
Supply Current per Amplifier	I_{SY}	$V_O = 0$ V $-40^\circ\text{C} < T_A < +125^\circ\text{C}$		2.5 3.0	3.0 3.5	mA mA
DYNAMIC PERFORMANCE						
Slew Rate	SR	$R_L = 2$ k Ω	40	50		V/ μs
Gain Bandwidth Product	GBP			25		MHz
Settling Time	t_S	$A_V = +1$, 4 V step, to 0.01%		350		ns
NOISE PERFORMANCE						
Voltage Noise	e_n p-p	0.1 Hz to 10 Hz		1.8		μV p-p
Voltage Noise Density	e_n	$f = 1$ kHz		6		nV/ $\sqrt{\text{Hz}}$
Current Noise Density	i_n	$f = 1$ kHz		5		fA/ $\sqrt{\text{Hz}}$
Input Capacitance	C_{IN}			8		pF
Differential Mode				15		pF
Common Mode						
Channel Separation	C_S			137		dB
$f = 10$ kHz				120		dB
$f = 300$ kHz						

AD8610/AD8620

ELECTRICAL SPECIFICATIONS

@ $V_S = \pm 13\text{ V}$, $V_{CM} = 0\text{ V}$, $T_A = 25^\circ\text{C}$, unless otherwise noted.

Table 2.

Parameter	Symbol	Conditions	Min	Typ	Max	Unit
INPUT CHARACTERISTICS						
Offset Voltage (AD8610B)	V_{OS}	$-40^\circ\text{C} < T_A < +125^\circ\text{C}$		45 80	100 200	μV μV
Offset Voltage (AD8620B)	V_{OS}	$-40^\circ\text{C} < T_A < +125^\circ\text{C}$		45 80	150 300	μV μV
Offset Voltage (AD8610A/AD8620A)	V_{OS}	$25^\circ\text{C} < T_A < 125^\circ\text{C}$ $-40^\circ\text{C} < T_A < +125^\circ\text{C}$		85 90 150	250 350 850	μV μV μV
Input Bias Current	I_B	$-40^\circ\text{C} < T_A < +85^\circ\text{C}$ $-40^\circ\text{C} < T_A < +125^\circ\text{C}$	-10 -250	+3 +130	+10 +250	pA pA
Input Offset Current	I_{OS}	$-40^\circ\text{C} < T_A < +85^\circ\text{C}$ $-40^\circ\text{C} < T_A < +125^\circ\text{C}$	-3.5 -10 -75 -150	+1.5 +20 +40	+3.5 +10 +75 +150	nA pA pA pA
Input Voltage Range			-10.5		+10.5	V
Common-Mode Rejection Ratio	CMRR	$V_{CM} = -10\text{ V to } +10\text{ V}$	90	110		dB
Large Signal Voltage Gain	A_{VO}	$R_L = 1\text{ k}\Omega$, $V_O = -10\text{ V to } +10\text{ V}$	100	200		V/mV
Offset Voltage Drift (AD8610B)	$\Delta V_{OS}/\Delta T$	$-40^\circ\text{C} < T_A < +125^\circ\text{C}$		0.5	1	$\mu\text{V}/^\circ\text{C}$
Offset Voltage Drift (AD8620B)	$\Delta V_{OS}/\Delta T$	$-40^\circ\text{C} < T_A < +125^\circ\text{C}$		0.5	1.5	$\mu\text{V}/^\circ\text{C}$
Offset Voltage Drift (AD8610A/AD8620A)	$\Delta V_{OS}/\Delta T$	$-40^\circ\text{C} < T_A < +125^\circ\text{C}$		0.8	3.5	$\mu\text{V}/^\circ\text{C}$
OUTPUT CHARACTERISTICS						
Output Voltage High	V_{OH}	$R_L = 1\text{ k}\Omega$, $-40^\circ\text{C} < T_A < +125^\circ\text{C}$	+11.75	+11.84		V
Output Voltage Low	V_{OL}	$R_L = 1\text{ k}\Omega$, $-40^\circ\text{C} < T_A < +125^\circ\text{C}$		-11.84	-11.75	V
Output Current	I_{OUT}	$V_{OUT} > 10\text{ V}$		± 45		mA
Short-Circuit Current	I_{SC}			± 65		mA
POWER SUPPLY						
Power Supply Rejection Ratio	PSRR	$V_S = \pm 5\text{ V to } \pm 13\text{ V}$	100	110		dB
Supply Current per Amplifier	I_{SY}	$V_O = 0\text{ V}$ $-40^\circ\text{C} < T_A < +125^\circ\text{C}$		3.0 3.5	3.5 4.0	mA mA
DYNAMIC PERFORMANCE						
Slew Rate	SR	$R_L = 2\text{ k}\Omega$	40	60		$\text{V}/\mu\text{s}$
Gain Bandwidth Product	GBP			25		MHz
Settling Time	t_S	$A_V = +1$, 10 V step, to 0.01%		600		ns
NOISE PERFORMANCE						
Voltage Noise	e_n p-p	0.1 Hz to 10 Hz		1.8		$\mu\text{V p-p}$
Voltage Noise Density	e_n	$f = 1\text{ kHz}$		6		$\text{nV}/\sqrt{\text{Hz}}$
Current Noise Density	i_n	$f = 1\text{ kHz}$		5		$\text{fA}/\sqrt{\text{Hz}}$
Input Capacitance	C_{IN}					
Differential Mode				8		pF
Common Mode				15		pF
Channel Separation	C_S					
$f = 10\text{ kHz}$				137		dB
$f = 300\text{ kHz}$				120		dB

ABSOLUTE MAXIMUM RATINGS

Table 3.

Parameter	Rating
Supply Voltage	27.3 V
Input Voltage	V_{S-} to V_{S+}
Differential Input Voltage	\pm Supply voltage
Output Short-Circuit Duration to GND	Indefinite
Storage Temperature Range	-65°C to +150°C
Operating Temperature Range	-40°C to +125°C
Junction Temperature Range	-65°C to +150°C
Lead Temperature (Soldering, 10 sec)	300°C

Stresses above those listed under Absolute Maximum Ratings may cause permanent damage to the device. This is a stress rating only; functional operation of the device at these or any other conditions above those indicated in the operational section of this specification is not implied. Exposure to absolute maximum rating conditions for extended periods may affect device reliability.

Table 4. Thermal Resistance

Package Type	θ_{JA} ¹	θ_{JC}	Unit
8-Lead MSOP (RM)	190	44	°C/W
8-Lead SOIC (R)	158	43	°C/W

¹ θ_{JA} is specified for worst-case conditions, that is, θ_{JA} is specified for a device soldered in circuit board for surface-mount packages.

ESD CAUTION



ESD (electrostatic discharge) sensitive device. Charged devices and circuit boards can discharge without detection. Although this product features patented or proprietary protection circuitry, damage may occur on devices subjected to high energy ESD. Therefore, proper ESD precautions should be taken to avoid performance degradation or loss of functionality.

TYPICAL PERFORMANCE CHARACTERISTICS



Figure 3. Input Offset Voltage



Figure 6. Input Offset Voltage vs. Temperature at $\pm 5V$ (300 Amplifiers)



Figure 4. Input Offset Voltage vs. Temperature at $\pm 13V$ (300 Amplifiers)



Figure 7. Input Offset Voltage Drift



Figure 5. Input Offset Voltage



Figure 8. Input Bias Current vs. Common-Mode Voltage



Figure 9. Supply Current vs. Supply Voltage

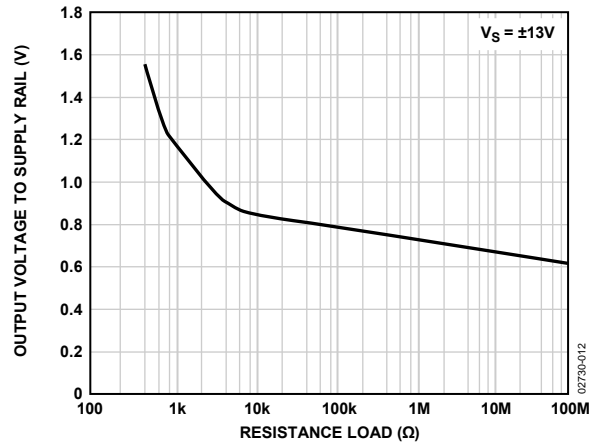

Figure 12. Output Voltage to Supply Rail vs. Resistance Load



Figure 10. Supply Current vs. Temperature

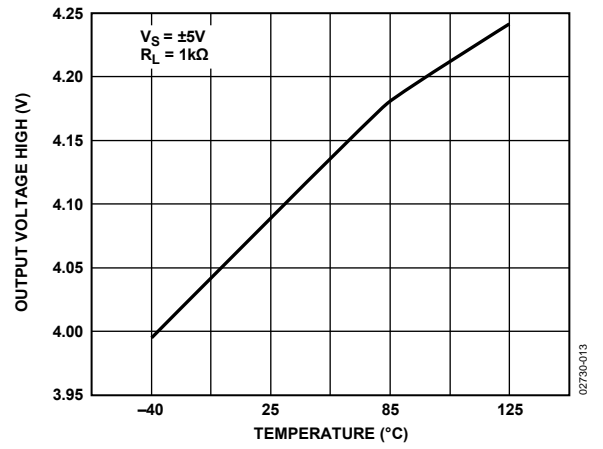

Figure 13. Output Voltage High vs. Temperature

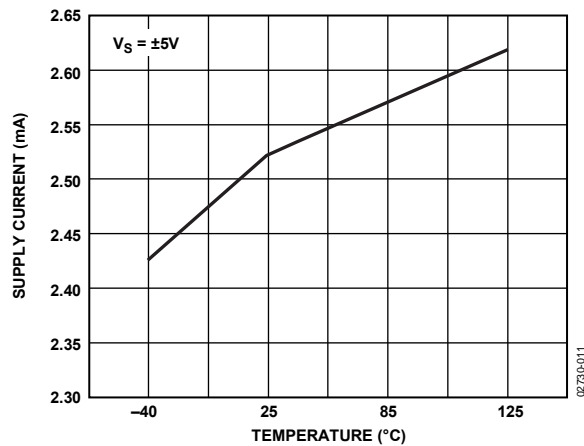

Figure 11. Supply Current vs. Temperature

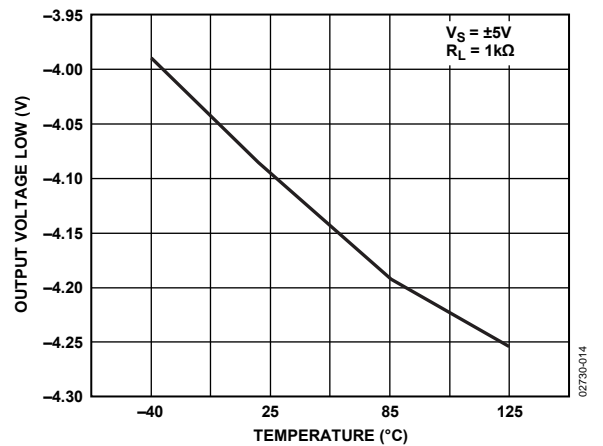

Figure 14. Output Voltage Low vs. Temperature

AD8610/AD8620



Figure 15. Output Voltage High vs. Temperature



Figure 18. Closed-Loop Gain vs. Frequency



Figure 16. Output Voltage Low vs. Temperature



Figure 19. A_{vO} vs. Temperature



Figure 17. Open-Loop Gain and Phase vs. Frequency



Figure 20. A_{vO} vs. Temperature



Figure 21. PSRR vs. Frequency



Figure 24. CMRR vs. Frequency



Figure 22. PSRR vs. Frequency



Figure 25. Positive Overvoltage Recovery



Figure 23. PSRR vs. Temperature



Figure 26. Negative Overvoltage Recovery



Figure 27. 0.1 Hz to 10 Hz Input Voltage Noise



Figure 30. Z_{OUT} vs. Frequency

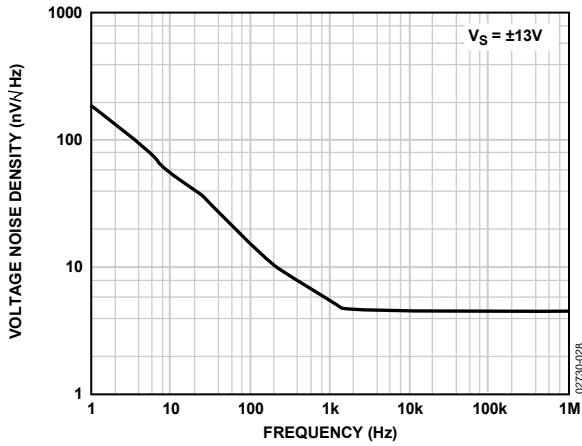

Figure 28. Input Voltage Noise Density vs. Frequency



Figure 31. Input Bias Current vs. Temperature

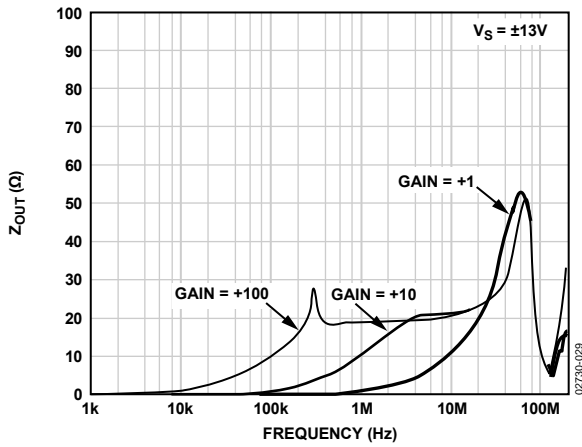

Figure 29. Z_{OUT} vs. Frequency



Figure 32. Small Signal Overshoot vs. Load Capacitance



Figure 33. Small Signal Overshoot vs. Load Capacitance

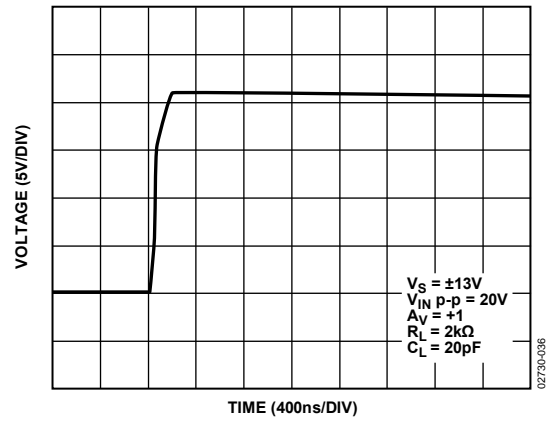

Figure 36. +Slew Rate at $G = +1$



Figure 34. No Phase Reversal

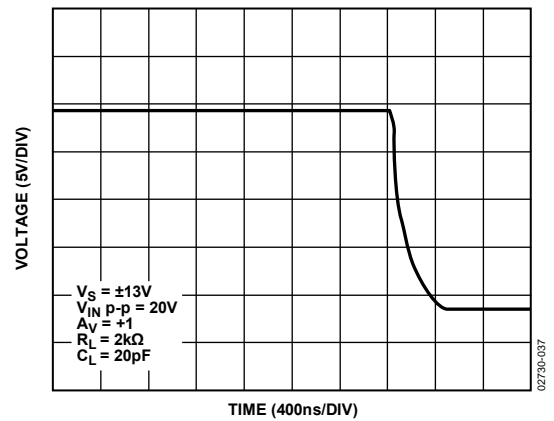

Figure 37. -Slew Rate at $G = +1$



Figure 35. Large Signal Response at $G = +1$

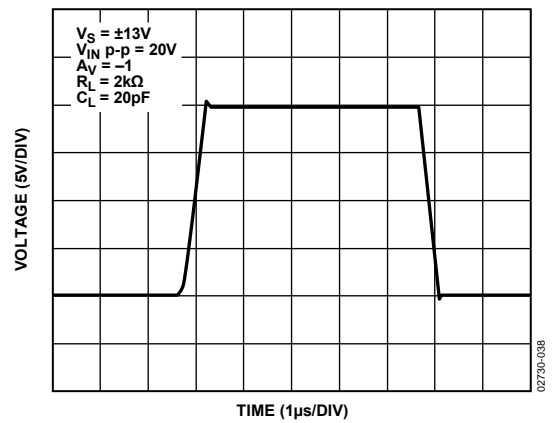

Figure 38. Large Signal Response at $G = -1$



Figure 39. +Slew Rate at $G = -1$



Figure 40. -Slew Rate at $G = -1$

THEORY OF OPERATION



Figure 41. Channel Separation Test Circuit

FUNCTIONAL DESCRIPTION

The AD8610/AD8620 are manufactured on the Analog Devices, Inc., XFCB (eXtra fast complementary bipolar) process. XFCB is fully dielectrically isolated (DI) and used in conjunction with N-channel JFET technology and thin film resistors (that can be trimmed) to create the JFET input amplifier. Dielectrically isolated NPN and PNP transistors fabricated on XFCB have an $f_t > 3$ GHz. Low TC thin film resistors enable very accurate offset voltage and offset voltage temperature coefficient trimming. These process breakthroughs allow Analog Devices IC designers to create an amplifier with faster slew rate and more than 50% higher bandwidth at half of the current consumed by its closest competition. The AD8610/AD8620 are unconditionally stable in all gains, even with capacitive loads well in excess of 1 nF. The AD8610B grade achieves less than 100 μ V of offset and 1 μ V/ $^{\circ}$ C of offset drift, numbers usually associated with very high precision bipolar input amplifiers. The AD8610 is offered in the tiny 8-lead MSOP as well as narrow 8-lead SOIC surface-mount packages and is fully specified with supply voltages from ± 5.0 V to ± 13 V. The very wide specified temperature range, up to 125 $^{\circ}$ C, guarantees superior operation in systems with little or no active cooling.

The unique input architecture of the AD8610/AD8620 features extremely low input bias currents and very low input offset voltage. Low power consumption minimizes the die temperature and maintains the very low input bias current. Unlike many competitive JFET amplifiers, the AD8610/AD8620 input bias currents are low even at elevated temperatures. Typical bias currents are less than 200 pA at 85 $^{\circ}$ C. The gate current of a JFET doubles every 10 $^{\circ}$ C, resulting in a similar increase in input bias current over temperature. Give special care to the PCB board layout to minimize leakage currents between PCB traces. Improper layout and board handling generates a leakage current that exceeds the bias current of the AD8610/AD8620.



Figure 42. AD8620 Channel Separation Graph

Power Consumption

A major advantage of the AD8610/AD8620 in new designs is the power saving capability. Lower power consumption of the AD8610/AD8620 makes them much more attractive for portable instrumentation and for high density systems, simplifying thermal management, and reducing power-supply performance requirements. Compare the power consumption of the AD8610 vs. the OPA627 in Figure 43.



Figure 43. Supply Current vs. Temperature

AD8610/AD8620

Driving Large Capacitive Loads

The AD8610/AD8620 have excellent capacitive load driving capability and can safely drive up to 10 nF when operating with a ± 5.0 V supply. Figure 44 and Figure 45 compare the AD8610/AD8620 against the OPA627 in the noninverting gain configuration driving a 10 k Ω resistor and 10,000 pF capacitor placed in parallel on its output, with a square wave input set to a frequency of 200 kHz. The AD8610/AD8620 have much less ringing than the OPA627 with heavy capacitive loads.



Figure 44. OPA627 Driving $C_L = 10,000$ pF



Figure 45. AD8610/AD8620 Driving $C_L = 10,000$ pF

The AD8610/AD8620 can drive much larger capacitances without any external compensation. Although the AD8610/AD8620 are stable with very large capacitive loads, remember that this capacitive loading limits the bandwidth of the amplifier. Heavy capacitive loads also increase the amount of overshoot and ringing at the output. Figure 47 and Figure 48 show the AD8610/AD8620 and the OPA627 in a noninverting gain of +2 driving 2 μ F of capacitance load. The ringing on the OPA627 is much larger in magnitude and continues 10 times longer than the AD8610/AD8620.



Figure 46. Capacitive Load Drive Test Circuit



Figure 47. OPA627 Capacitive Load Drive, $A_V = +2$



Figure 48. AD8610/AD8620 Capacitive Load Drive, $A_V = +2$

Slew Rate (Unity Gain Inverting vs. Noninverting)

Amplifiers generally have a faster slew rate in an inverting unity gain configuration due to the absence of the differential input capacitance. Figure 49 through Figure 52 show the performance of the AD8610/AD8620 configured in a unity gain of -1 compared to the OPA627. The AD8610/AD8620 slew rate is more symmetrical, and both the positive and negative transitions are much cleaner than in the OPA627.



Figure 49. +Slew Rate of AD8610/AD8620 in Unity Gain of -1

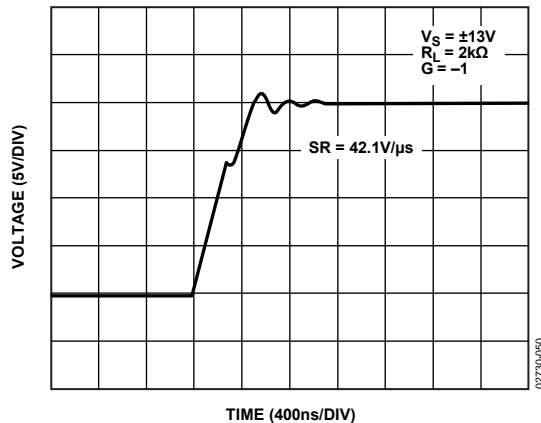

Figure 50. +Slew Rate of OPA627 in Unity Gain of -1



Figure 51. -Slew Rate of AD8610/AD8620 in Unity Gain of -1



Figure 52. -Slew Rate of OPA627 in Unity Gain of -1

The AD8610/AD8620 have a very fast slew rate of $60 \text{ V}/\mu\text{s}$ even when configured in a noninverting gain of $+1$. This is the toughest condition to impose on any amplifier because the input common-mode capacitance of the amplifier generally makes its SR appear worse. The slew rate of an amplifier varies according to the voltage difference between its two inputs. To observe the maximum SR, a voltage difference of about 2 V between the inputs must be ensured. This is required for virtually any JFET op amp so that one side of the op amp input circuit is completely off, thus maximizing the current available to charge and discharge the internal compensation capacitance. Lower differential drive voltages produce lower slew rate readings. A JFET input op amp with a slew rate of $60 \text{ V}/\mu\text{s}$ at unity gain with $V_{\text{IN}} = 10 \text{ V}$ may slew at $20 \text{ V}/\mu\text{s}$ if it is operated at a gain of $+100$ with $V_{\text{IN}} = 100 \text{ mV}$.

AD8610/AD8620

The slew rate of the AD8610/AD8620 is double that of the OPA627 when configured in a unity gain of +1 (see Figure 53 and Figure 54).



Figure 53. +Slew Rate of AD8610/AD8620 in Unity Gain of +1



Figure 54. +Slew Rate of OPA627 in Unity Gain of +1

The slew rate of an amplifier determines the maximum frequency at which it can respond to a large signal input. This frequency (known as full power bandwidth or FPBW) can be calculated for a given distortion (for example, 1%) from the equation

$$FPBW = \frac{SR}{(2\pi \times V_{PEAK})}$$



Figure 55. AD8610 FPBW

Input Overvoltage Protection

When the input of an amplifier is driven below V_{EE} or above V_{CC} by more than one V_{BE} , large currents flow from the substrate through the negative supply (V_{-}) or the positive supply (V_{+}), respectively, to the input pins and can destroy the device. If the input source can deliver larger currents than the maximum forward current of the diode (>5 mA), a series resistor can be added to protect the inputs. With its very low input bias and offset current, a large series resistor can be placed in front of the AD8610/AD8620 inputs to limit current to below damaging levels. Series resistance of 10 k Ω generates less than 25 μ V of offset. This 10 k Ω allows input voltages more than 5 V beyond either power supply. Thermal noise generated by the resistor adds 7.5 nV/ $\sqrt{\text{Hz}}$ to the noise of the AD8610/AD8620. For the AD8610/AD8620, differential voltages equal to the supply voltage do not cause any problems (see Figure 55). In this context, note that the high breakdown voltage of the input FETs eliminates the need to include clamp diodes between the inputs of the amplifier, a practice that is mandatory on many precision op amps. Unfortunately, clamp diodes greatly interfere with many application circuits, such as precision rectifiers and comparators. The AD8610/AD8620 are free from these limitations.



Figure 56. Unity Gain Follower

No Phase Reversal

Many amplifiers misbehave when one or both of the inputs are forced beyond the input common-mode voltage range. Phase reversal is typified by the transfer function of the amplifier, effectively reversing its transfer polarity. In some cases, this can cause lockup and even equipment damage in servo systems and can cause permanent damage or no recoverable parameter shifts to the amplifier itself. Many amplifiers feature compensation circuitry to combat these effects, but some are only effective for the inverting input. The AD8610/AD8620 are designed to prevent phase reversal when one or both inputs are forced beyond their input common-mode voltage range.



Figure 57. No Phase Reversal

THD Readings vs. Common-Mode Voltage

Total harmonic distortion of the AD8610/AD8620 is well below 0.0006% with any load down to 600 Ω. The AD8610 outperforms the OPA627 for distortion, especially at frequencies above 20 kHz.



Figure 58. AD8610 vs. OPA627 THD + Noise @ $V_{CM} = 0 V$



Figure 59. THD + Noise vs. Frequency

Noise vs. Common-Mode Voltage

The AD8610/AD8620 noise density varies only 10% over the input range, as shown in Table 5.

Table 5. Noise vs. Common-Mode Voltage

V_{CM} at $f = 1 \text{ kHz}$ (V)	Noise Reading (nV/ $\sqrt{\text{Hz}}$)
-10	7.21
-5	6.89
0	6.73
+5	6.41
+10	7.21

Settling Time

The AD8610/AD8620 have a very fast settling time, even to a very tight error band, as can be seen from Figure 60. The AD8610/AD8620 are configured in an inverting gain of +1 with 2 kΩ input and feedback resistors. The output is monitored with a 10×, 10 MΩ, 11.2 pF scope probe.



Figure 60. AD8610/AD8620 Settling Time vs. Error Band



Figure 61. OPA627 Settling Time vs. Error Band

AD8610/AD8620

The AD8610/AD8620 maintain this fast settling time when loaded with large capacitive loads, as shown in Figure 62.



Figure 62. AD8610/AD8620 Settling Time vs. Load Capacitance



Figure 63. OPA627 Settling Time vs. Load Capacitance

Output Current Capability

The AD8610/AD8620 can drive very heavy loads due to its high output current. It is capable of sourcing or sinking 45 mA at ± 10 V output. The short-circuit current is quite high and the part is capable of sinking about 95 mA and sourcing over 60 mA while operating with supplies of ± 13 V. Figure 64 and Figure 65 compare the output voltage vs. load current of AD8610/AD8620 and OPA627.



Figure 64. AD8610/AD8620 Dropout from ± 13 V vs. Load Current



Figure 65. OPA627 Dropout from ± 15 V vs. Load Current

Although operating conditions imposed on the AD8610/AD8620 (± 13 V) are less favorable than the OPA627 (± 15 V), it can be seen that the AD8610/AD8620 have much better drive capability (lower headroom to the supply) for a given load current.

Operating with Supplies Greater than ± 13 V

The AD8610/AD8620 maximum operating voltage is specified at ± 13 V. When ± 13 V is not readily available, an inexpensive LDO can provide ± 12 V from a nominal ± 15 V supply.

Input Offset Voltage Adjustment

Offset of AD8610 is very small and normally does not require additional offset adjustment. However, the offset adjust pins can be used as shown in Figure 66 to further reduce the dc offset. By using resistors in the range of 50 kΩ, offset trim range is ±3.3 mV.



Figure 66. Offset Voltage Nulling Circuit

Programmable Gain Amplifier (PGA)

The combination of low noise, low input bias current, low input offset voltage, and low temperature drift make the AD8610/AD8620 a perfect solution for programmable gain amplifiers. PGAs are often used immediately after sensors to increase the dynamic range of the measurement circuit. Historically, the large on resistance of switches (combined with the large I_B currents of amplifiers) created a large dc offset in PGAs. Recent and improved monolithic switches and amplifiers completely remove these problems. A PGA discrete circuit is shown in Figure 67. In Figure 67, when the 10 pA bias current of the AD8610 is dropped across the (<5 Ω) R_{ON} of the switch, it results in a negligible offset error.

When high precision resistors are used, as in the circuit of Figure 67, the error introduced by the PGA is within the ½ LSB requirement for a 16-bit system.

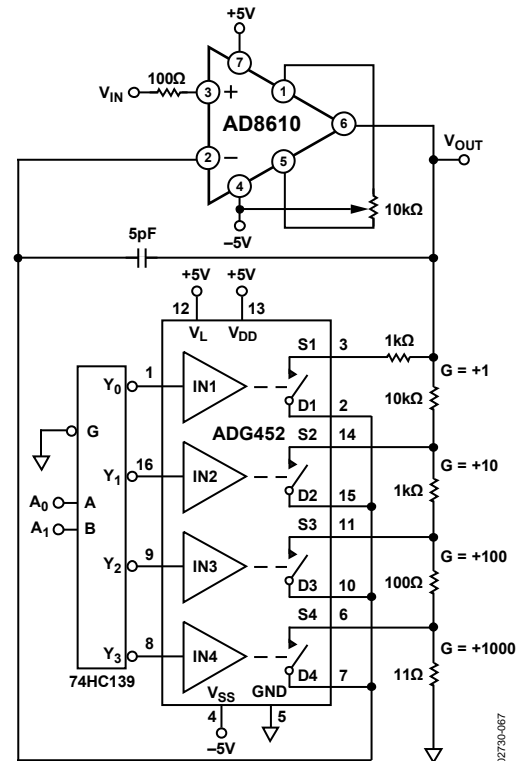

Figure 67. High Precision PGA

- Room temperature error calculation due to R_{ON} and I_B

$$\Delta V_{OS} = I_B \times R_{ON} = 2 \text{ pA} \times 5 \Omega = 10 \text{ pV}$$

$$\text{Total Offset} = \text{AD8610 (Offset)} + \Delta V_{OS}$$

$$\text{Total Offset} = \text{AD8610 (Offset_Trimmed)} + \Delta V_{OS}$$

$$\text{Total Offset} = 5 \mu\text{V} + 10 \text{ pV} \approx 5 \mu\text{V}$$
- Full temperature error calculation due to R_{ON} and I_B

$$\Delta V_{OS} (@ 85^\circ\text{C}) = I_B (@ 85^\circ\text{C}) \times R_{ON} (@ 85^\circ\text{C}) =$$

$$250 \text{ pA} \times 15 \Omega = 3.75 \text{ nV}$$
- The temperature coefficient of switch and AD8610/AD8620 combined is essentially the same as the $T_C V_{OS}$ of the AD8610/AD8620.

$$\Delta V_{OS}/\Delta T(\text{total}) = \Delta V_{OS}/\Delta T(\text{AD8610/AD8620}) + \Delta V_{OS}/\Delta T(I_B \times R_{ON})$$

$$\Delta V_{OS}/\Delta T(\text{total}) = 0.5 \mu\text{V}/^\circ\text{C} + 0.06 \text{ nV}/^\circ\text{C} \approx 0.5 \mu\text{V}/^\circ\text{C}$$

AD8610/AD8620

High Speed Instrumentation Amplifier

The 3-op-amp instrumentation amplifiers shown in Figure 68 can provide a range of gains from unity up to 1000 or higher. The instrumentation amplifier configuration features high common-mode rejection, balanced differential inputs, and stable, accurately defined gain. Low input bias currents and fast settling are achieved with the JFET input AD8610/AD8620. Most instrumentation amplifiers cannot match the high frequency performance of this circuit. The circuit bandwidth is 25 MHz at a gain of 1, and close to 5 MHz at a gain of 10. Settling time for the entire circuit is 550 ns to 0.01% for a 10 V step (gain = 10). Note that the resistors around the input pins need to be small enough in value so that the RC time constant they form in combination with stray circuit capacitance does not reduce circuit bandwidth.

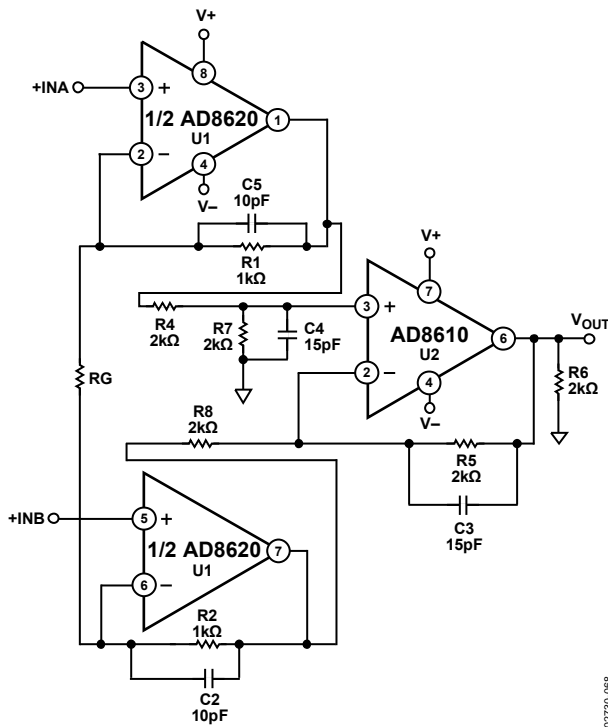

Figure 68. High Speed Instrumentation Amplifier

High Speed Filters

The four most popular configurations are Butterworth, Elliptical, Bessel (Thompson), and Chebyshev. Each type has a response that is optimized for a given characteristic, as shown in Table 6.

Table 6. Filter Types

Type	Sensitivity	Overshoot	Phase	Amplitude (Pass Band)
Butterworth	Moderate	Good		Maximum flat
Chebyshev	Good	Moderate	Nonlinear	Equal ripple
Elliptical	Best	Poor		Equal ripple
Bessel (Thompson)	Poor	Best	Linear	

In active filter applications using operational amplifiers, the dc accuracy of the amplifier is critical to optimal filter performance. The offset voltage and bias current of the amplifier contribute to output error. Input offset voltage is passed by the filter and can be amplified to produce excessive output offset. For low frequency applications requiring large value input resistors, bias and offset currents flowing through these resistors also generate an offset voltage.

At higher frequencies, the dynamic response of the amplifier must be carefully considered. In this case, slew rate, bandwidth, and open-loop gain play a major role in amplifier selection. The slew rate must be both fast and symmetrical to minimize distortion. The bandwidth of the amplifier, in conjunction with the gain of the filter, dictates the frequency response of the filter. The use of high performance amplifiers, such as the AD8610/AD8620, minimizes both dc and ac errors in all active filter applications.

Second-Order, Low-Pass Filter

Figure 69 shows the AD8610 configured as a second-order, Butterworth, low-pass filter. With the values as shown, the design corner was 1 MHz, and the bench measurement was 974 kHz. The wide bandwidth of the AD8610/AD8620 allows corner frequencies into the megahertz range, but the input capacitances should be taken into account by making C1 and C2 smaller than the calculated values. The following equations can be used for component selection:

$$R1 = R2 = \text{User Selected (Typical Values = 10 k}\Omega \text{ to 100 k}\Omega)$$

$$C1 = \frac{1.414}{(2\pi)(f_{CUTOFF})(R1)}$$

$$C2 = \frac{0.707}{(2\pi)(f_{CUTOFF})(R1)}$$

where C1 and C2 are in farads.



Figure 69. Second-Order, Low-Pass Filter

High Speed, Low Noise Differential Driver

The AD8620 is a perfect candidate as a low noise differential driver for many popular ADCs. There are also other applications (such as balanced lines) that require differential drivers. The circuit of Figure 70 is a unique line driver widely used in industrial applications. With ± 13 V supplies, the line driver can deliver a differential signal of 23 V p-p into a 1 k Ω load. The high slew rate and wide bandwidth of the AD8620 combine to yield a full power bandwidth of 145 kHz while the low noise front end produces a referred-to-input noise voltage spectral density of 6 nV/ $\sqrt{\text{Hz}}$. The design is a balanced transmission system without transformers, where output common-mode rejection of noise is of paramount importance. Like the transformer-based design, either output can be shorted to ground for unbalanced line driver applications without changing the circuit gain of 1. This allows the design to be easily set to noninverting, inverting, or differential operation.



Figure 70. Differential Driver

02730-070

AD8610/AD8620

OUTLINE DIMENSIONS



COMPLIANT TO JEDEC STANDARDS MO-187-AA

Figure 71. 8-Lead Mini Small Outline Package [MSOP] (RM-8)
Dimensions shown in millimeters

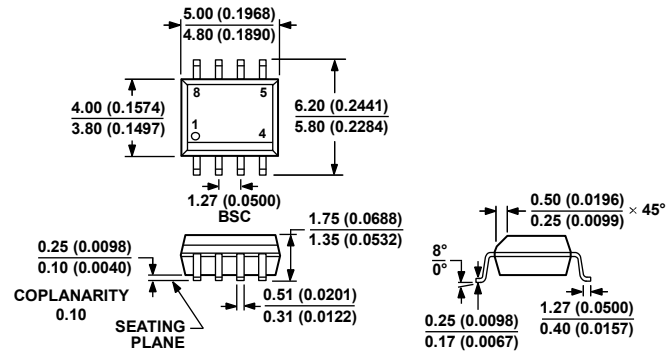

COMPLIANT TO JEDEC STANDARDS MS-012-AA

CONTROLLING DIMENSIONS ARE IN MILLIMETERS; INCH DIMENSIONS (IN PARENTHESES) ARE ROUNDED-OFF MILLIMETER EQUIVALENTS FOR REFERENCE ONLY AND ARE NOT APPROPRIATE FOR USE IN DESIGN.

Figure 72. 8-Lead Standard Small Outline Package [SOIC_N] Narrow Body (R-8)
Dimensions shown in millimeters and (inches)

ORDERING GUIDE

Model	Temperature Range	Package Description	Package Option	Branding
AD8610AR	-40°C to +125°C	8-Lead SOIC_N	R-8	
AD8610AR-REEL	-40°C to +125°C	8-Lead SOIC_N	R-8	
AD8610AR-REEL7	-40°C to +125°C	8-Lead SOIC_N	R-8	
AD8610ARZ ¹	-40°C to +125°C	8-Lead SOIC_N	R-8	
AD8610ARZ-REEL ¹	-40°C to +125°C	8-Lead SOIC_N	R-8	
AD8610ARZ-REEL7 ¹	-40°C to +125°C	8-Lead SOIC_N	R-8	
AD8610ARM-REEL	-40°C to +125°C	8-Lead MSOP	RM-8	BOA
AD8610ARM-R2	-40°C to +125°C	8-Lead MSOP	RM-8	BOA
AD8610ARMZ-REEL ¹	-40°C to +125°C	8-Lead MSOP	RM-8	BOA#
AD8610ARMZ-R2 ¹	-40°C to +125°C	8-Lead MSOP	RM-8	BOA#
AD8610BR	-40°C to +125°C	8-Lead SOIC_N	R-8	
AD8610BR-REEL	-40°C to +125°C	8-Lead SOIC_N	R-8	
AD8610BR-REEL7	-40°C to +125°C	8-Lead SOIC_N	R-8	
AD8610BRZ ¹	-40°C to +125°C	8-Lead SOIC_N	R-8	
AD8610BRZ-REEL ¹	-40°C to +125°C	8-Lead SOIC_N	R-8	
AD8610BRZ-REEL7 ¹	-40°C to +125°C	8-Lead SOIC_N	R-8	
AD8620AR	-40°C to +125°C	8-Lead SOIC_N	R-8	
AD8620AR-REEL	-40°C to +125°C	8-Lead SOIC_N	R-8	
AD8620AR-REEL7	-40°C to +125°C	8-Lead SOIC_N	R-8	
AD8620ARZ ¹	-40°C to +125°C	8-Lead SOIC_N	R-8	
AD8620ARZ-REEL ¹	-40°C to +125°C	8-Lead SOIC_N	R-8	
AD8620ARZ-REEL7 ¹	-40°C to +125°C	8-Lead SOIC_N	R-8	
AD8620BR	-40°C to +125°C	8-Lead SOIC_N	R-8	
AD8620BR-REEL	-40°C to +125°C	8-Lead SOIC_N	R-8	
AD8620BR-REEL7	-40°C to +125°C	8-Lead SOIC_N	R-8	
AD8620BRZ ¹	-40°C to +125°C	8-Lead SOIC_N	R-8	
AD8620BRZ-REEL ¹	-40°C to +125°C	8-Lead SOIC_N	R-8	
AD8620BRZ-REEL7 ¹	-40°C to +125°C	8-Lead SOIC_N	R-8	

¹ Z = RoHS Compliant Part, # denotes RoHS-compliant product can be top or bottom marked.

NOTES

NOTES

Компания «Life Electronics» занимается поставками электронных компонентов импортного и отечественного производства от производителей и со складов крупных дистрибьюторов Европы, Америки и Азии.

С конца 2013 года компания активно расширяет линейку поставок компонентов по направлению коаксиальный кабель, кварцевые генераторы и конденсаторы (керамические, пленочные, электролитические), за счёт заключения дистрибьюторских договоров

Мы предлагаем:

- Конкуренспособные цены и скидки постоянным клиентам.
- Специальные условия для постоянных клиентов.
- Подбор аналогов.
- Поставку компонентов в любых объемах, удовлетворяющих вашим потребностям.
- Приемлемые сроки поставки, возможна ускоренная поставка.
- Доставку товара в любую точку России и стран СНГ.
- Комплексную поставку.
- Работу по проектам и поставку образцов.
- Формирование склада под заказчика.
- Сертификаты соответствия на поставляемую продукцию (по желанию клиента).
- Тестирование поставляемой продукции.
- Поставку компонентов, требующих военную и космическую приемку.
- Входной контроль качества.
- Наличие сертификата ISO.

В составе нашей компании организован Конструкторский отдел, призванный помогать разработчикам, и инженерам.

Конструкторский отдел помогает осуществить:

- Регистрацию проекта у производителя компонентов.
- Техническую поддержку проекта.
- Защиту от снятия компонента с производства.
- Оценку стоимости проекта по компонентам.
- Изготовление тестовой платы монтаж и пусконаладочные работы.



Тел: +7 (812) 336 43 04 (многоканальный)
Email: org@lifeelectronics.ru