

BC846BDW1, BC847BDW1, BC848CDW1

Dual General Purpose Transistors

NPN Duals

These transistors are designed for general purpose amplifier applications. They are housed in the SOT-363/SC-88 which is designed for low power surface mount applications.

Features

- S and NSV Prefixes for Automotive and Other Applications Requiring Unique Site and Control Change Requirements; AEC-Q101 Qualified and PPAP Capable
- These Devices are Pb-Free, Halogen Free/BFR Free and are RoHS Compliant*

MAXIMUM RATINGS

Rating	Symbol	BC846	BC847	BC848	Unit
Collector-Emitter Voltage	V_{CEO}	65	45	30	V
Collector-Base Voltage	V_{CBO}	80	50	30	V
Emitter-Base Voltage	V_{EBO}	6.0	6.0	5.0	V
Collector Current – Continuous	I_C	100	100	100	mAdc

Stresses exceeding those listed in the Maximum Ratings table may damage the device. If any of these limits are exceeded, device functionality should not be assumed, damage may occur and reliability may be affected.

THERMAL CHARACTERISTICS

Characteristic	Symbol	Max	Unit
Total Device Dissipation Per Device FR-5 Board (Note 1) $T_A = 25^\circ\text{C}$ Derate Above 25°C	P_D	380 250 3.0	mW mW mW/ $^\circ\text{C}$
Thermal Resistance, Junction to Ambient	$R_{\theta JA}$	328	$^\circ\text{C}/\text{W}$
Junction and Storage Temperature Range	T_J, T_{stg}	-55 to +150	$^\circ\text{C}$

1. FR-5 = 1.0 x 0.75 x 0.062 in



ON Semiconductor®

www.onsemi.com



SOT-363/SC-88
CASE 419B
STYLE 1

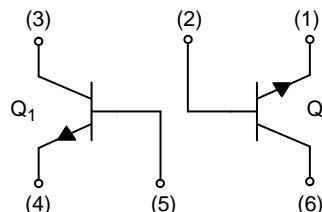

MARKING DIAGRAM

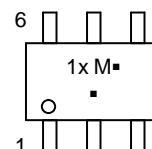

1x = Specific Device Code
x = B, F, G, L
M = Date Code
▪ = Pb-Free Package

(Note: Microdot may be in either location)

ORDERING INFORMATION

See detailed ordering and shipping information in the package dimensions section on page 6 of this data sheet.

*For additional information on our Pb-Free strategy and soldering details, please download the ON Semiconductor Soldering and Mounting Techniques Reference Manual, SOLDERRM/D.

BC846BDW1, BC847BDW1, BC848CDW1

ELECTRICAL CHARACTERISTICS (T_A = 25°C unless otherwise noted)

Characteristic	Symbol	Min	Typ	Max	Unit
OFF CHARACTERISTICS					
Collector–Emitter Breakdown Voltage (I _C = 10 mA) BC846 BC847 BC848	V _{(BR)CEO}	65 45 30	– – –	– – –	V
Collector–Emitter Breakdown Voltage (I _C = 10 μA, V _{EB} = 0) BC846 BC847 BC848	V _{(BR)CES}	80 50 30	– – –	– – –	V
Collector–Base Breakdown Voltage (I _C = 10 μA) BC846 BC847 BC848	V _{(BR)CBO}	80 50 30	– – –	– – –	V
Emitter–Base Breakdown Voltage (I _E = 1.0 μA) BC846 BC847 BC848	V _{(BR)EBO}	6.0 6.0 5.0	– – –	– – –	V
Collector Cutoff Current (V _{CB} = 30 V) (V _{CB} = 30 V, T _A = 150°C)	I _{CBO}	– –	– –	15 5.0	nA μA

ON CHARACTERISTICS

DC Current Gain (I _C = 10 μA, V _{CE} = 5.0 V) BC846B, BC847B BC847C, BC848C (I _C = 2.0 mA, V _{CE} = 5.0 V) BC846B, BC847B BC847C, BC848C	h _{FE}	– – 200 420	150 270 290 520	– – 450 800	–
Collector–Emitter Saturation Voltage (I _C = 10 mA, I _B = 0.5 mA) (I _C = 100 mA, I _B = 5.0 mA)	V _{CE(sat)}	– –	– –	0.25 0.6	V
Base–Emitter Saturation Voltage (I _C = 10 mA, I _B = 0.5 mA) (I _C = 100 mA, I _B = 5.0 mA)	V _{BE(sat)}	– –	0.7 0.9	– –	V
Base–Emitter Voltage (I _C = 2.0 mA, V _{CE} = 5.0 V) (I _C = 10 mA, V _{CE} = 5.0 V)	V _{BE(on)}	580 –	660 –	700 770	mV

SMALL–SIGNAL CHARACTERISTICS

Current–Gain – Bandwidth Product (I _C = 10 mA, V _{CE} = 5.0 Vdc, f = 100 MHz)	f _T	100	–	–	MHz
Output Capacitance (V _{CB} = 10 V, f = 1.0 MHz)	C _{obo}	–	–	4.5	pF
Noise Figure (I _C = 0.2 mA, V _{CE} = 5.0 Vdc, R _S = 2.0 kΩ, f = 1.0 kHz, BW = 200 Hz)	NF	–	–	10	dB

Product parametric performance is indicated in the Electrical Characteristics for the listed test conditions, unless otherwise noted. Product performance may not be indicated by the Electrical Characteristics if operated under different conditions.

BC846BDW1, BC847BDW1, BC848CDW1

TYPICAL CHARACTERISTICS – BC846BDW1

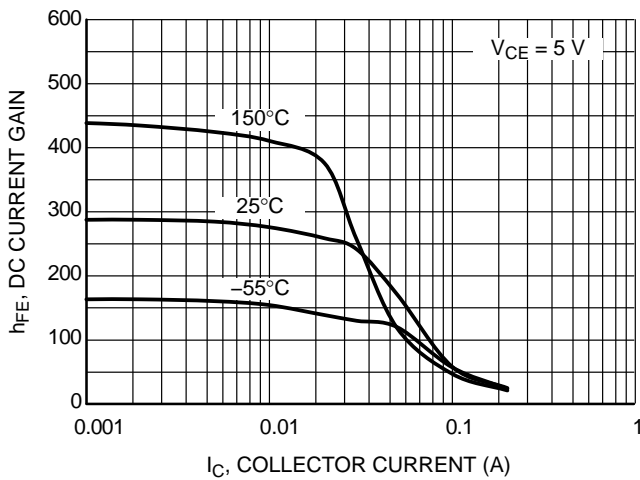

Figure 1. DC Current Gain at $V_{CE} = 5 V$

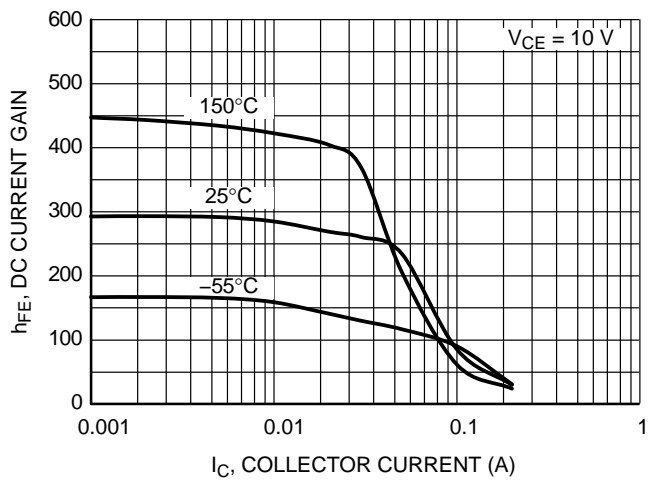

Figure 2. DC Current Gain at $V_{CE} = 10 V$

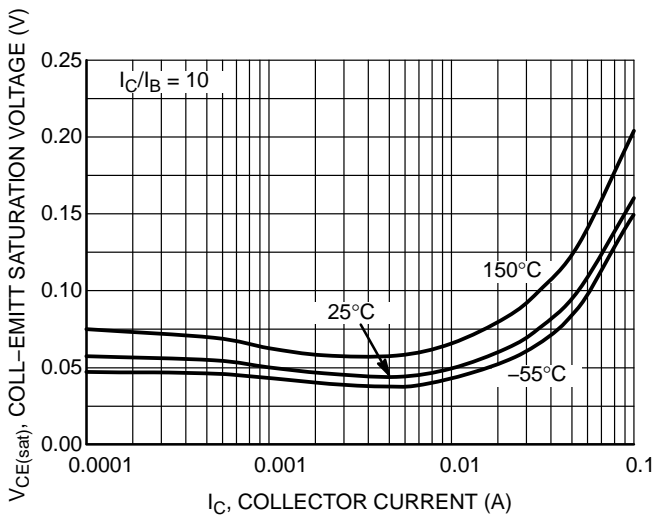

Figure 3. $V_{CE(sat)}$ at $I_C/I_B = 10$

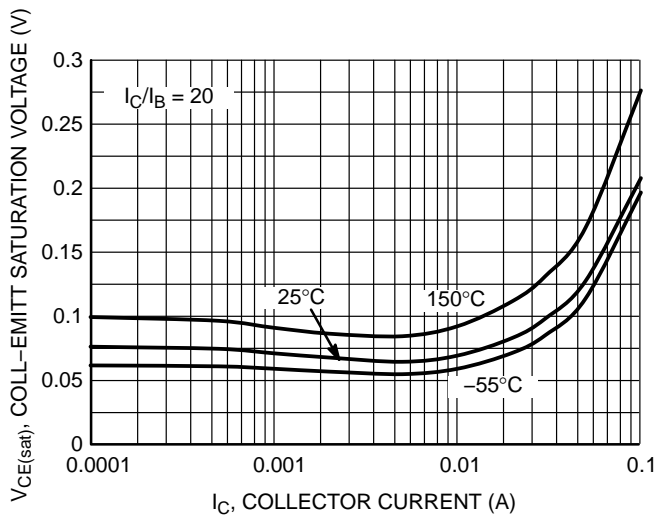

Figure 4. $V_{CE(sat)}$ at $I_C/I_B = 20$

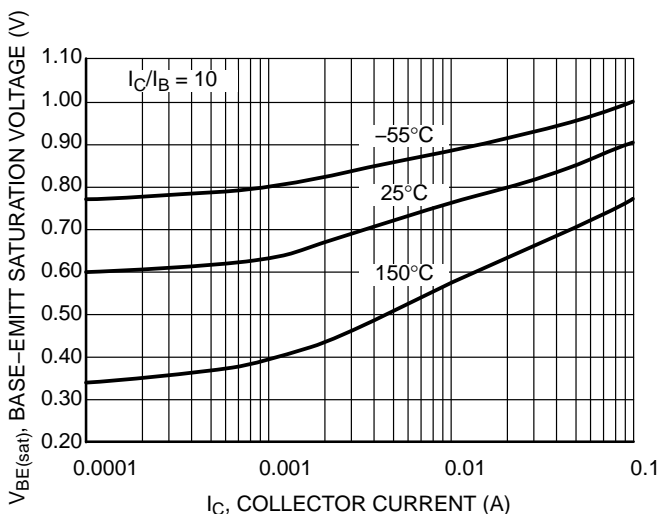

Figure 5. $V_{BE(sat)}$ at $I_C/I_B = 10$

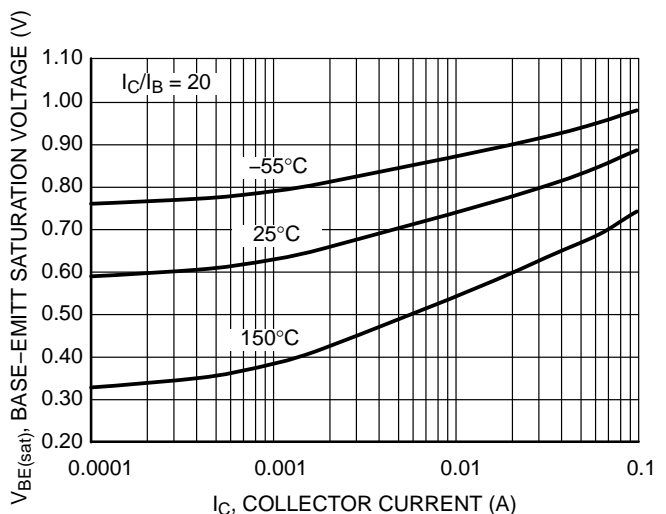

Figure 6. $V_{BE(sat)}$ at $I_C/I_B = 20$

BC846BDW1, BC847BDW1, BC848CDW1

TYPICAL CHARACTERISTICS – BC846BDW1

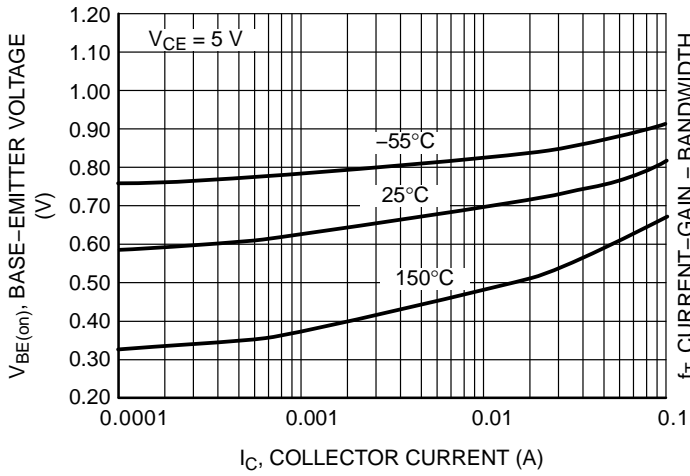

Figure 7. $V_{BE(on)}$ at $V_{CE} = 5\text{ V}$

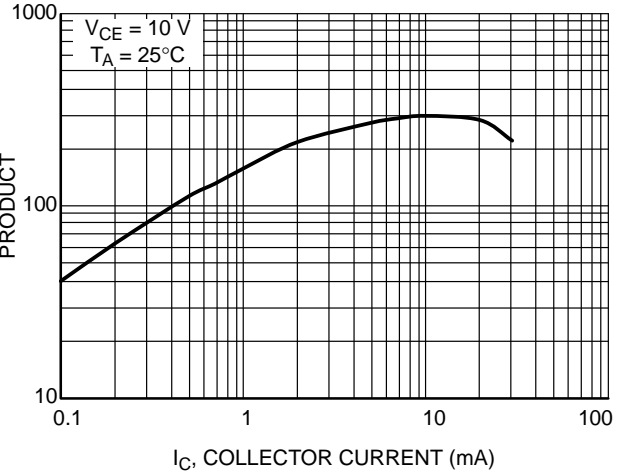

Figure 8. Current – Gain – Bandwidth Product

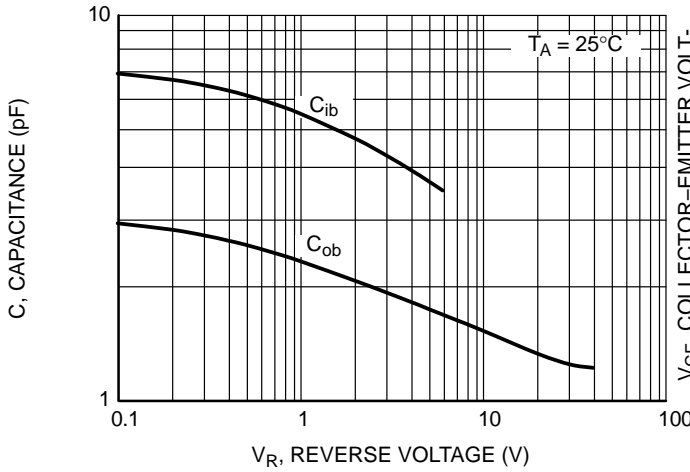

Figure 9. Capacitances

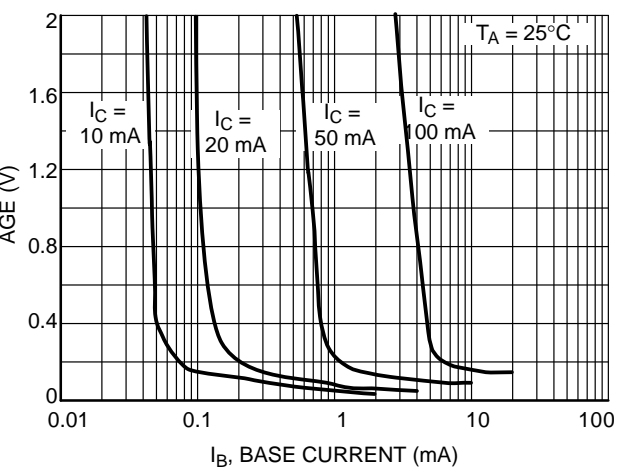

Figure 10. Collector Saturation Region

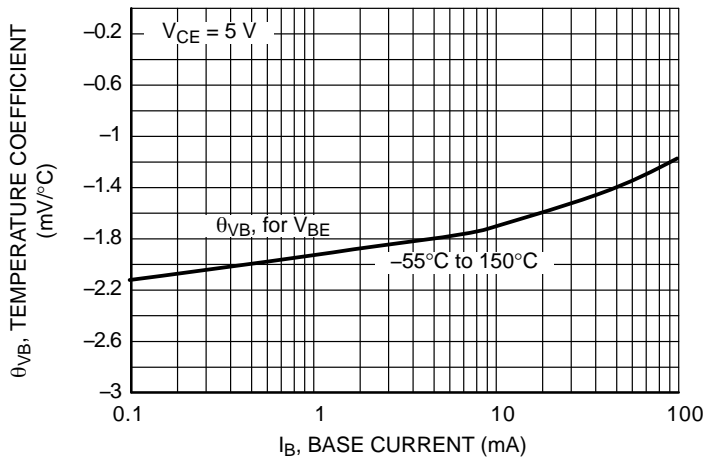

Figure 11. Base-Emitter Temperature Coefficient

BC846BDW1, BC847BDW1, BC848CDW1

TYPICAL CHARACTERISTICS – BC847BDW1

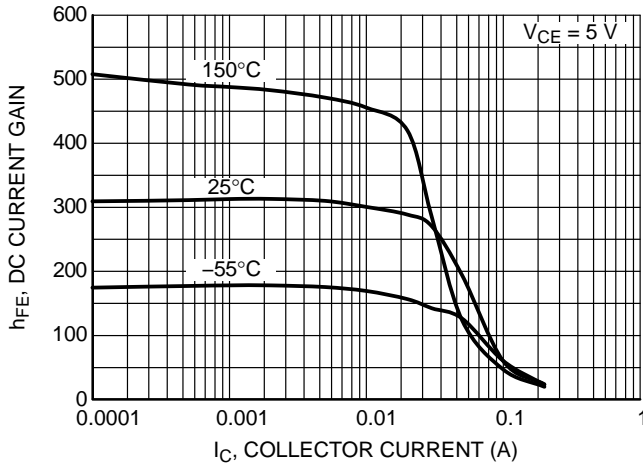

Figure 12. DC Current Gain at $V_{CE} = 5\text{ V}$

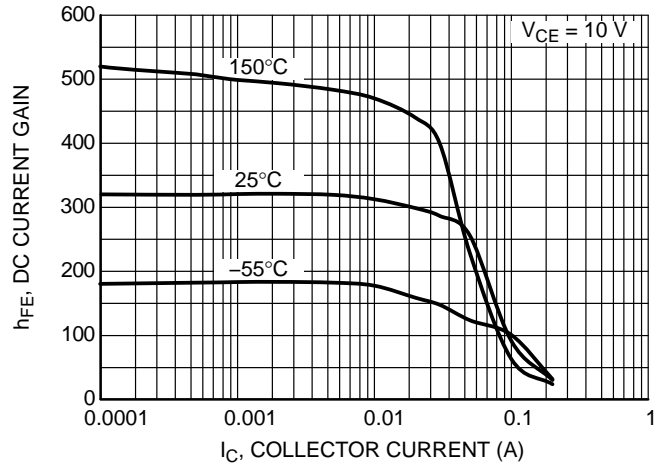

Figure 13. DC Current Gain at $V_{CE} = 10\text{ V}$

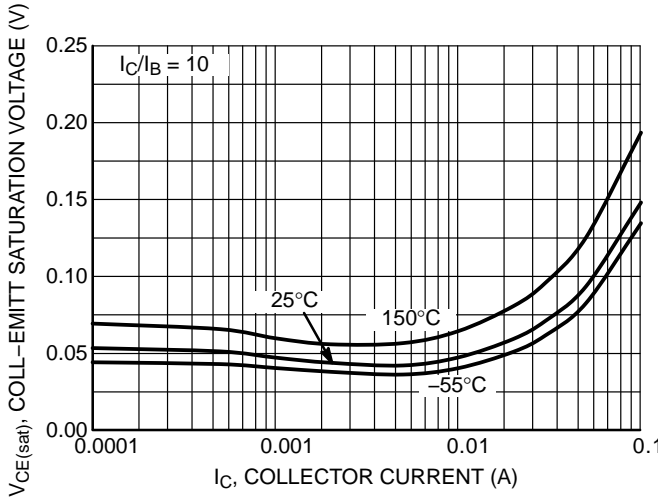

Figure 14. V_{CE} at $I_C/I_B = 10$

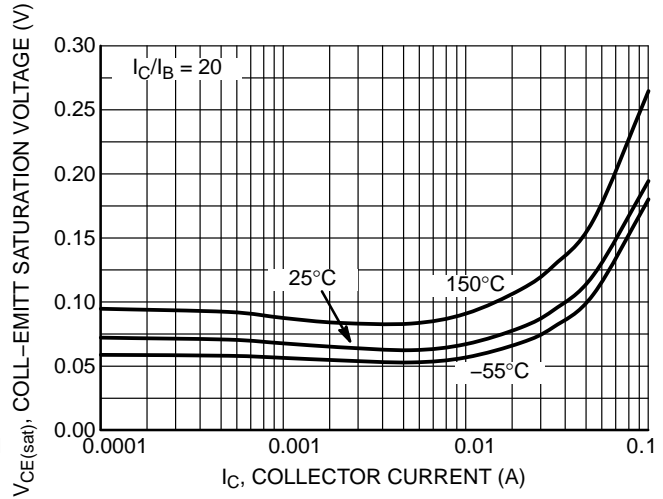

Figure 15. V_{CE} at $I_C/I_B = 20$

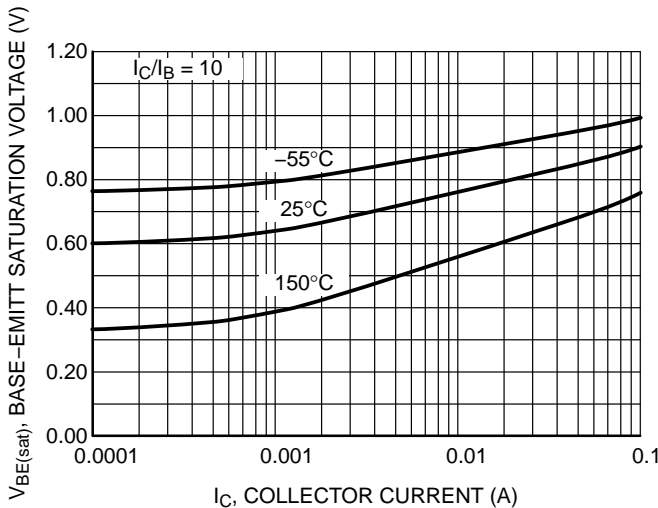

Figure 16. $V_{BE(sat)}$ at $I_C/I_B = 10$

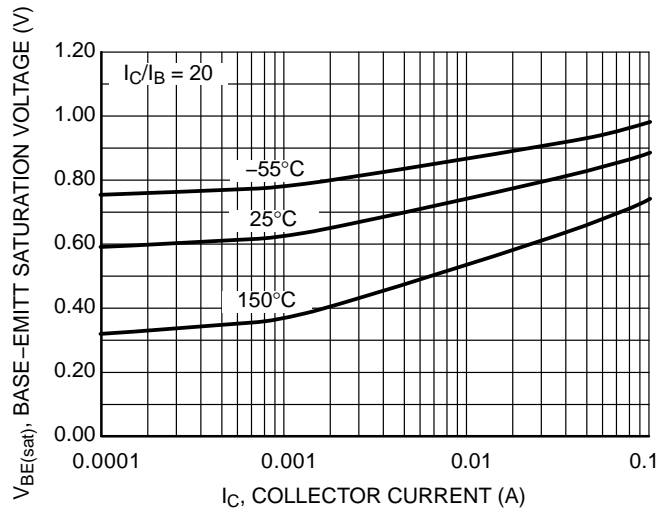

Figure 17. $V_{BE(sat)}$ at $I_C/I_B = 20$

BC846BDW1, BC847BDW1, BC848CDW1

TYPICAL CHARACTERISTICS – BC847BDW1

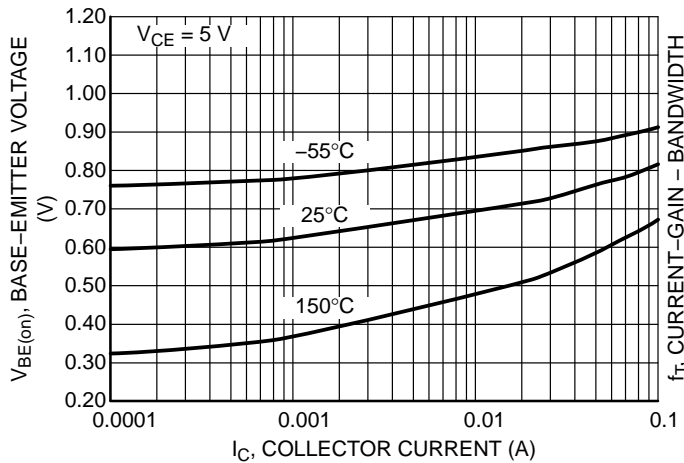

Figure 18. $V_{BE(on)}$ at $V_{CE} = 5\text{ V}$

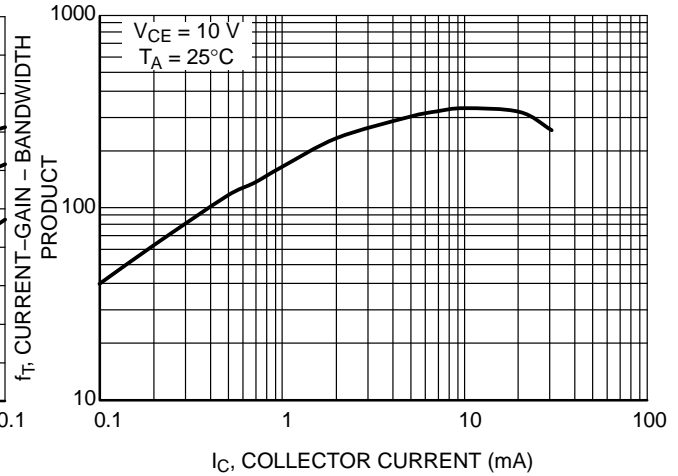

Figure 19. Current - Gain - Bandwidth Product

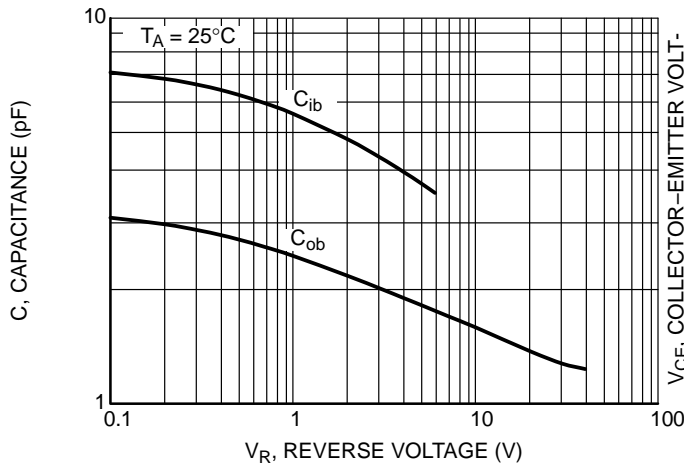

Figure 20. Capacitances

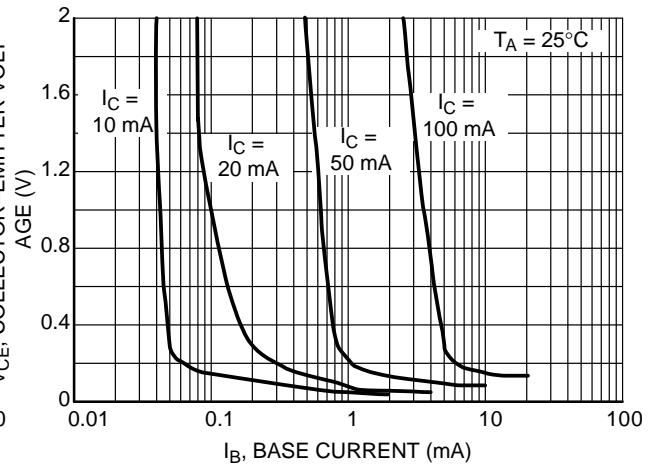

Figure 21. Collector Saturation Region

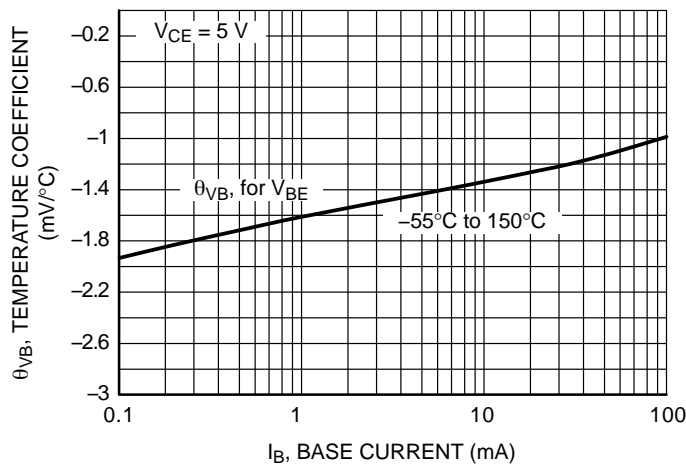

Figure 22. Base-Emitter Temperature Coefficient

BC846BDW1, BC847BDW1, BC848CDW1

TYPICAL CHARACTERISTICS – BC848CDW1

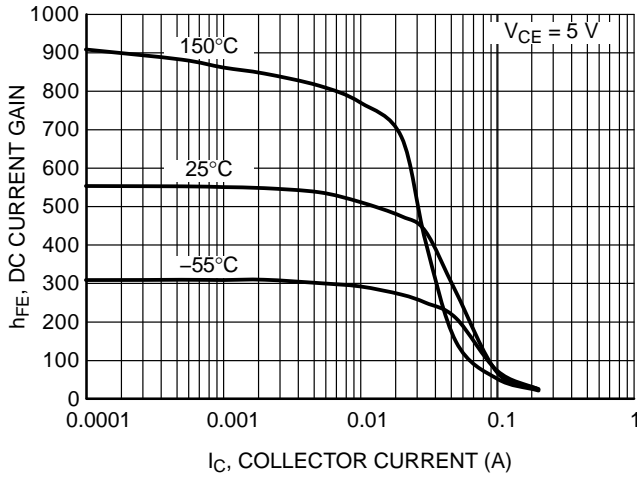

Figure 23. DC Current Gain at $V_{CE} = 5\text{ V}$

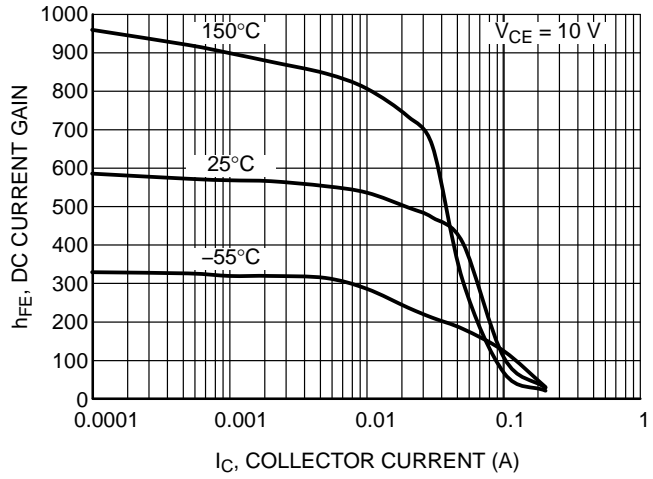

Figure 24. DC Current Gain at $V_{CE} = 10\text{ V}$

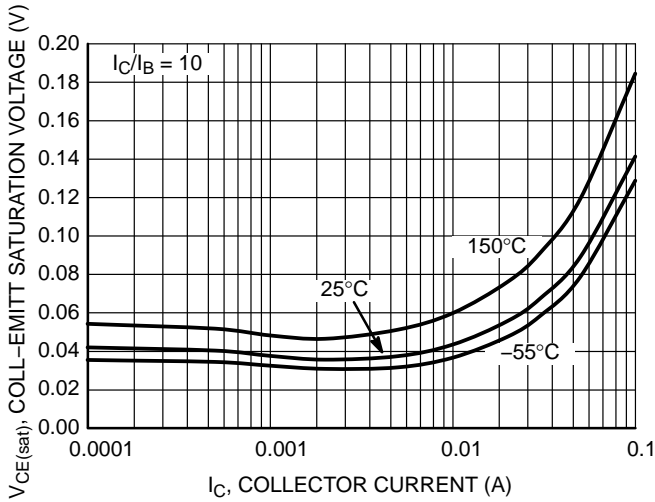

Figure 25. V_{CE} at $I_C/I_B = 10$

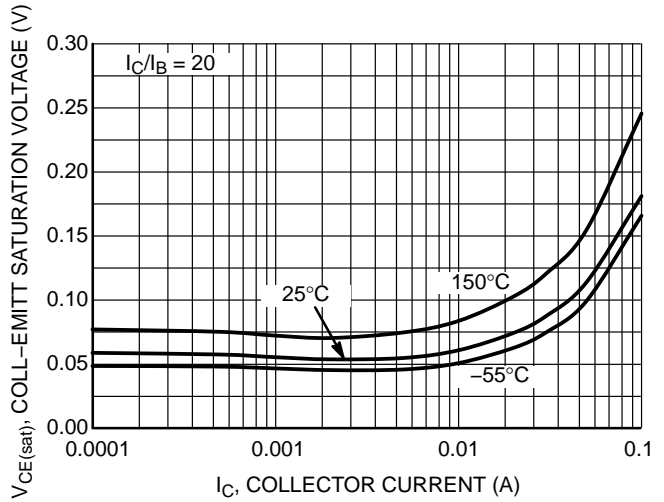

Figure 26. V_{CE} at $I_C/I_B = 20$

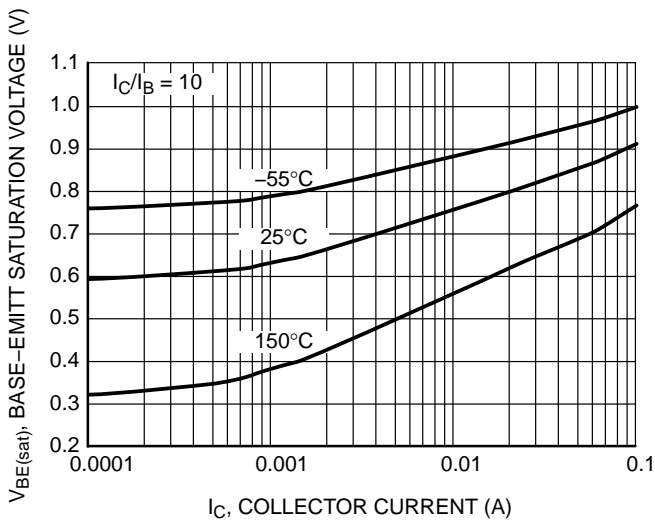

Figure 27. $V_{BE}(\text{sat})$ at $I_C/I_B = 10$

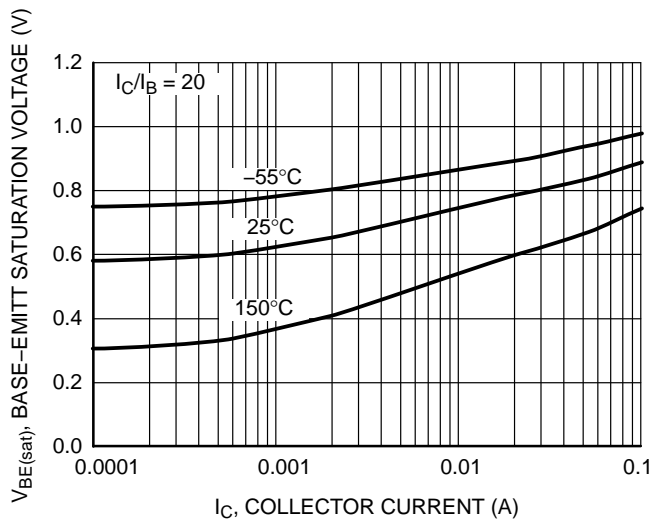

Figure 28. $V_{BE}(\text{sat})$ at $I_C/I_B = 20$

BC846BDW1, BC847BDW1, BC848CDW1

TYPICAL CHARACTERISTICS – BC848CDW1

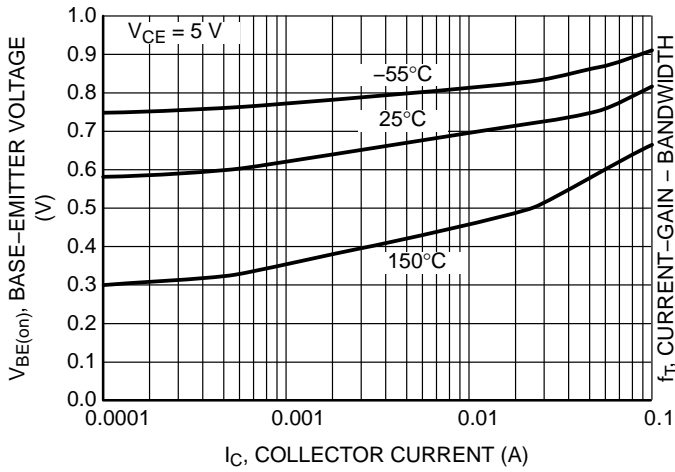

Figure 29. $V_{BE(on)}$ at $V_{CE} = 5\text{ V}$

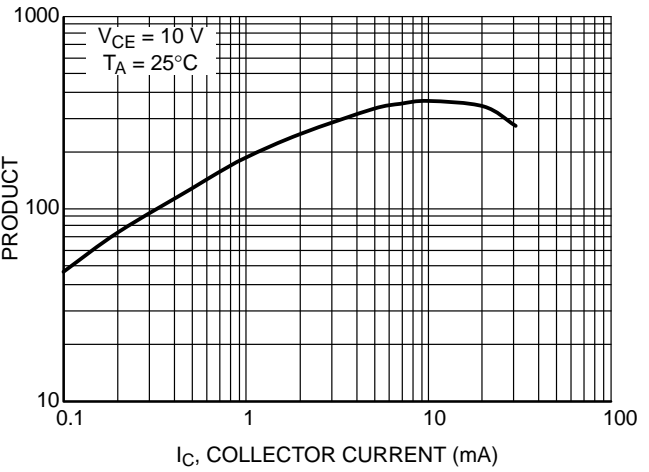

Figure 30. Current – Gain – Bandwidth Product

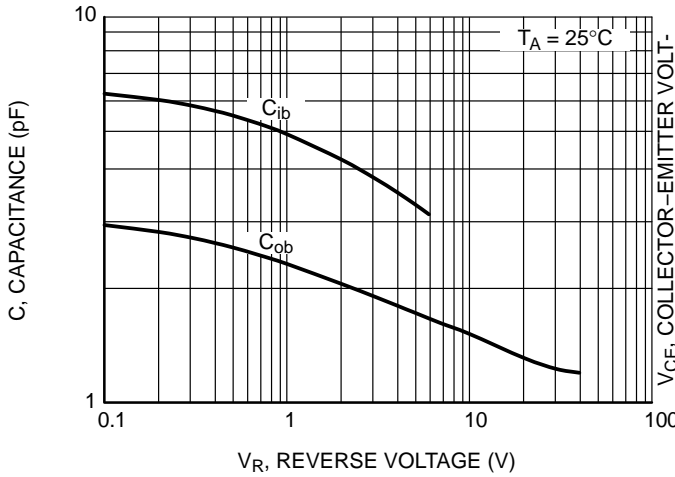

Figure 31. Capacitances

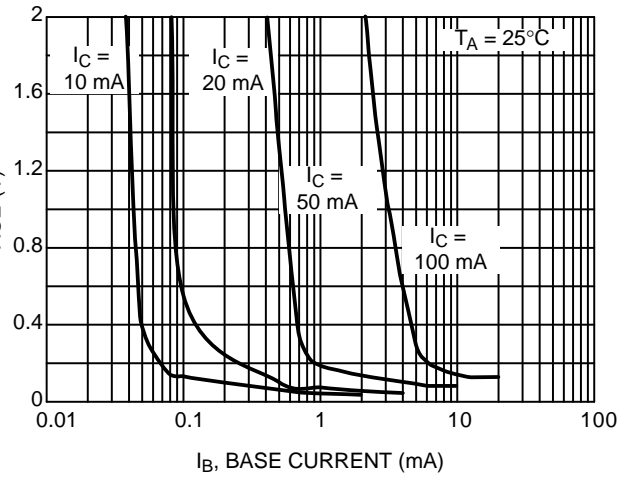

Figure 32. Collector Saturation Region

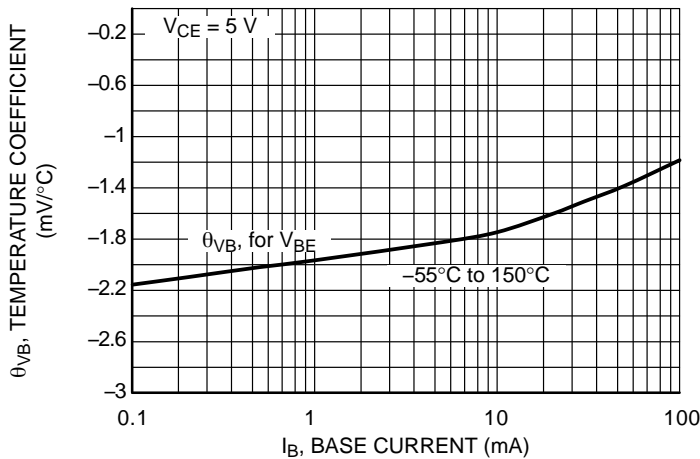

Figure 33. Base-Emitter Temperature Coefficient

BC846BDW1, BC847BDW1, BC848CDW1

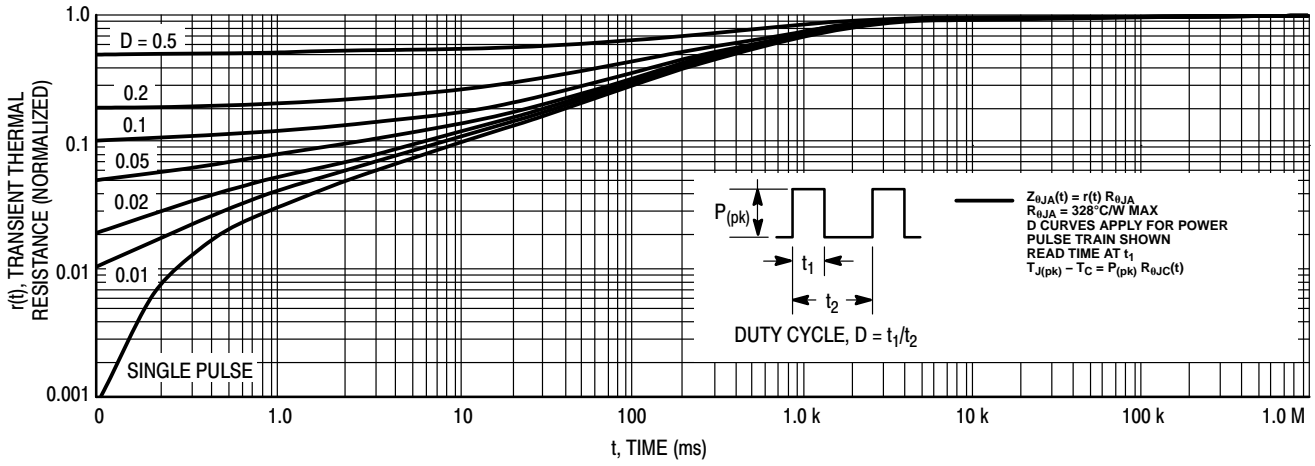

Figure 34. Thermal Response

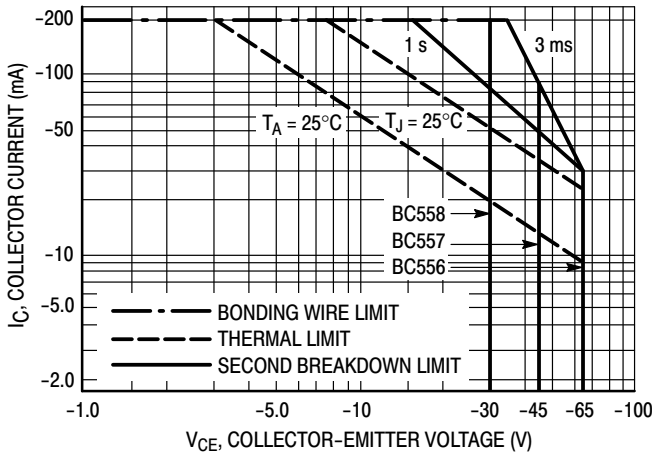

Figure 35. Active Region Safe Operating Area

The safe operating area curves indicate I_C - V_{CE} limits of the transistor that must be observed for reliable operation. Collector load lines for specific circuits must fall below the limits indicated by the applicable curve.

The data of Figure 35 is based upon $T_{j(pk)} = 150^\circ\text{C}$; T_C or T_A is variable depending upon conditions. Pulse curves are valid for duty cycles to 10% provided $T_{j(pk)} \leq 150^\circ\text{C}$. $T_{j(pk)}$ may be calculated from the data in Figure 34. At high case or ambient temperatures, thermal limitations will reduce the power that can be handled to values less than the limitations imposed by the secondary breakdown.

BC846BDW1, BC847BDW1, BC848CDW1

ORDERING INFORMATION

Device	Markings	Package	Shipping [†]
BC846BDW1T1G	1B	SOT-363 (Pb-Free)	3,000 / Tape & Reel
SBC846BDW1T1G*	1B	SOT-363 (Pb-Free)	3,000 / Tape & Reel
BC847BDW1T1G	1F	SOT-363 (Pb-Free)	3,000 / Tape & Reel
SBC847BDW1T1G*	1F	SOT-363 (Pb-Free)	3,000 / Tape & Reel
BC847BDW1T3G	1F	SOT-363 (Pb-Free)	10,000 / Tape & Reel
SBC847BDW1T3G*	1F	SOT-363 (Pb-Free)	10,000 / Tape & Reel
NSVBC847BDW1T2G*	1F	SOT-363 (Pb-Free)	10,000 / Tape & Reel
BC847CDW1T1G	1G	SOT-363 (Pb-Free)	3,000 / Tape & Reel
SBC847CDW1T1G*	1G	SOT-363 (Pb-Free)	3,000 / Tape & Reel
BC848CDW1T1G	1L	SOT-363 (Pb-Free)	3,000 / Tape & Reel
NSVBC848CDW1T1G*	1L	SOT-363 (Pb-Free)	3,000 / Tape & Reel

[†]For information on tape and reel specifications, including part orientation and tape sizes, please refer to our Tape and Reel Packaging Specifications Brochure, BRD8011/D.

*S and NSV Prefixes for Automotive and Other Applications Requiring Unique Site and Control Change Requirements; AEC-Q101 Qualified and PPAP Capable.

BC846BDW1, BC847BDW1, BC848CDW1

PACKAGE DIMENSIONS

SC-88/SC70-6/SOT-363
CASE 419B-02
ISSUE Y

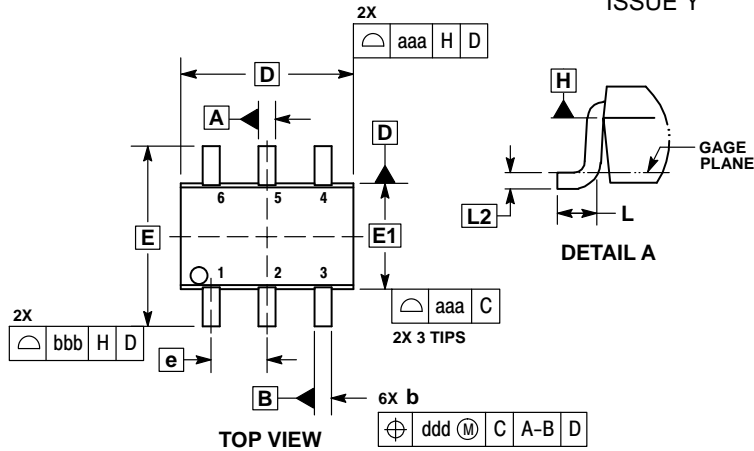

- NOTES:
1. DIMENSIONING AND TOLERANCING PER ASME Y14.5M, 1994.
 2. CONTROLLING DIMENSION: MILLIMETERS.
 3. DIMENSIONS D AND E1 DO NOT INCLUDE MOLD FLASH, PROTRUSIONS, OR GATE BURRS. MOLD FLASH, PROTRUSIONS, OR GATE BURRS SHALL NOT EXCEED 0.20 PER END.
 4. DIMENSIONS D AND E1 AT THE OUTERMOST EXTREMES OF THE PLASTIC BODY AND DATUM H.
 5. DATUMS A AND B ARE DETERMINED AT DATUM H.
 6. DIMENSIONS b AND c APPLY TO THE FLAT SECTION OF THE LEAD BETWEEN 0.08 AND 0.15 FROM THE TIP.
 7. DIMENSION b DOES NOT INCLUDE DAMBAR PROTRUSION. ALLOWABLE DAMBAR PROTRUSION SHALL BE 0.08 TOTAL IN EXCESS OF DIMENSION b AT MAXIMUM MATERIAL CONDITION. THE DAMBAR CANNOT BE LOCATED ON THE LOWER RADIUS OF THE FOOT.

DIM	MILLIMETERS			INCHES		
	MIN	NOM	MAX	MIN	NOM	MAX
A	---	---	1.10	---	---	0.043
A1	0.00	---	0.10	0.000	---	0.004
A2	0.70	0.90	1.00	0.027	0.035	0.039
b	0.15	0.20	0.25	0.006	0.008	0.010
C	0.08	0.15	0.22	0.003	0.006	0.009
D	1.80	2.00	2.20	0.070	0.078	0.086
E	2.00	2.10	2.20	0.078	0.082	0.086
E1	1.15	1.25	1.35	0.045	0.049	0.053
e	0.65 BSC			0.026 BSC		
L	0.26	0.36	0.46	0.010	0.014	0.018
L2	0.15 BSC			0.006 BSC		
aaa	0.15			0.006		
bbb	0.30			0.012		
ccc	0.10			0.004		
ddd	0.10			0.004		

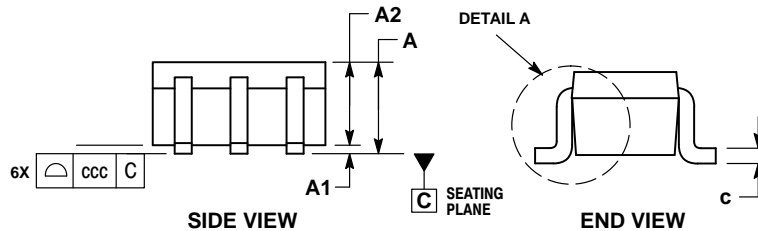

RECOMMENDED SOLDERING FOOTPRINT*

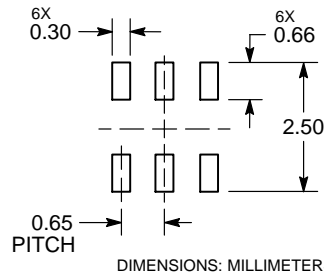

- STYLE 1:
PIN 1. EMITTER 2
2. BASE 2
3. COLLECTOR 1
4. EMITTER 1
5. BASE 1
6. COLLECTOR 2

*For additional information on our Pb-Free strategy and soldering details, please download the ON Semiconductor Soldering and Mounting Techniques Reference Manual, SOLDERRM/D.

ON Semiconductor and are trademarks of Semiconductor Components Industries, LLC dba ON Semiconductor or its subsidiaries in the United States and/or other countries. ON Semiconductor owns the rights to a number of patents, trademarks, copyrights, trade secrets, and other intellectual property. A listing of ON Semiconductor's product/patent coverage may be accessed at www.onsemi.com/site/pdf/Patent-Marketing.pdf. ON Semiconductor reserves the right to make changes without further notice to any products herein. ON Semiconductor makes no warranty, representation or guarantee regarding the suitability of its products for any particular purpose, nor does ON Semiconductor assume any liability arising out of the application or use of any product or circuit, and specifically disclaims any and all liability, including without limitation special, consequential or incidental damages. Buyer is responsible for its products and applications using ON Semiconductor products, including compliance with all laws, regulations and safety requirements or standards, regardless of any support or applications information provided by ON Semiconductor. "Typical" parameters which may be provided in ON Semiconductor data sheets and/or specifications can and do vary in different applications and actual performance may vary over time. All operating parameters, including "Typicals" must be validated for each customer application by customer's technical experts. ON Semiconductor does not convey any license under its patent rights nor the rights of others. ON Semiconductor products are not designed, intended, or authorized for use as a critical component in life support systems or any FDA Class 3 medical devices or medical devices with a same or similar classification in a foreign jurisdiction or any devices intended for implantation in the human body. Should Buyer purchase or use ON Semiconductor products for any such unintended or unauthorized application, Buyer shall indemnify and hold ON Semiconductor and its officers, employees, subsidiaries, affiliates, and distributors harmless against all claims, costs, damages, and expenses, and reasonable attorney fees arising out of, directly or indirectly, any claim of personal injury or death associated with such unintended or unauthorized use, even if such claim alleges that ON Semiconductor was negligent regarding the design or manufacture of the part. ON Semiconductor is an Equal Opportunity/Affirmative Action Employer. This literature is subject to all applicable copyright laws and is not for resale in any manner.

PUBLICATION ORDERING INFORMATION

LITERATURE FULFILLMENT:
Literature Distribution Center for ON Semiconductor
P.O. Box 5163, Denver, Colorado 80217 USA
Phone: 303-675-2175 or 800-344-3860 Toll Free USA/Canada
Fax: 303-675-2176 or 800-344-3867 Toll Free USA/Canada
Email: orderlit@onsemi.com

N. American Technical Support: 800-282-9855 Toll Free
USA/Canada
Europe, Middle East and Africa Technical Support:
Phone: 421 33 790 2910
Japan Customer Focus Center
Phone: 81-3-5817-1050

ON Semiconductor Website: www.onsemi.com
Order Literature: <http://www.onsemi.com/orderlit>
For additional information, please contact your local Sales Representative

Компания «Life Electronics» занимается поставками электронных компонентов импортного и отечественного производства от производителей и со складов крупных дистрибьюторов Европы, Америки и Азии.

С конца 2013 года компания активно расширяет линейку поставок компонентов по направлению коаксиальный кабель, кварцевые генераторы и конденсаторы (керамические, пленочные, электролитические), за счёт заключения дистрибьюторских договоров

Мы предлагаем:

- Конкуренспособные цены и скидки постоянным клиентам.
- Специальные условия для постоянных клиентов.
- Подбор аналогов.
- Поставку компонентов в любых объемах, удовлетворяющих вашим потребностям.
- Приемлемые сроки поставки, возможна ускоренная поставка.
- Доставку товара в любую точку России и стран СНГ.
- Комплексную поставку.
- Работу по проектам и поставку образцов.
- Формирование склада под заказчика.
- Сертификаты соответствия на поставляемую продукцию (по желанию клиента).
- Тестирование поставляемой продукции.
- Поставку компонентов, требующих военную и космическую приемку.
- Входной контроль качества.
- Наличие сертификата ISO.

В составе нашей компании организован Конструкторский отдел, призванный помогать разработчикам, и инженерам.

Конструкторский отдел помогает осуществить:

- Регистрацию проекта у производителя компонентов.
- Техническую поддержку проекта.
- Защиту от снятия компонента с производства.
- Оценку стоимости проекта по компонентам.
- Изготовление тестовой платы монтаж и пусконаладочные работы.



Тел: +7 (812) 336 43 04 (многоканальный)

Email: org@lifeelectronics.ru