

Phase Control Thyristors (Stud Version), 1650 A

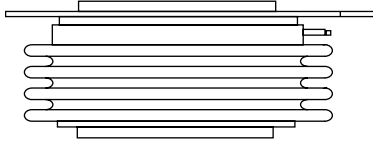

A-24 (K-PUK)

FEATURES

- Center amplifying gate
- Metal case with ceramic insulator
- International standard case A-24 (K-PUK)
- High profile hockey PUK
- Compliant to RoHS directive 2002/95/EC
- Designed and qualified for industrial level

RoHS
COMPLIANT

PRODUCT SUMMARY

$I_{T(AV)}$	1650 A
-------------	--------

TYPICAL APPLICATIONS

- DC motor controls
- Controlled DC power supplies
- AC controllers

MAJOR RATINGS AND CHARACTERISTICS

PARAMETER	TEST CONDITIONS	VALUES	UNITS
$I_{T(AV)}$		1650	A
	T_{hs}	55	°C
$I_{T(RMS)}$		3080	A
	T_{hs}	25	°C
I_{TSM}	50 Hz	30 500	A
	60 Hz	32 000	
I^2t	50 Hz	4651	kA ² s
	60 Hz	4250	
V_{DRM}/V_{RRM}		1200 to 2000	V
t_q	Typical	200	µs
T_J		- 40 to 125	°C

ELECTRICAL SPECIFICATIONS
VOLTAGE RATINGS

TYPE NUMBER	VOLTAGE CODE	V_{DRM}/V_{RRM} , MAXIMUM REPETITIVE PEAK AND OFF-STATE VOLTAGE V	V_{RSM} , MAXIMUM NON-REPETITIVE PEAK VOLTAGE V	I_{DRM}/I_{RRM} MAXIMUM AT $T_J = T_J$ MAXIMUM mA
ST1200C..K	12	1200	1300	100
	14	1400	1500	
	16	1600	1700	
	18	1800	1900	
	20	2000	2100	

ABSOLUTE MAXIMUM RATINGS					
PARAMETER	SYMBOL	TEST CONDITIONS		VALUES	UNITS
Maximum average on-state current at heatsink temperature	$I_{T(AV)}$	180° conduction, half sine wave double side (single side) cooled		1650 (700)	A
				55 (85)	°C
Maximum RMS on-state current	$I_{T(RMS)}$	DC at 25 °C heatsink temperature double side cooled		3080	A
Maximum peak, one-cycle non-repetitive surge current	I_{TSM}	t = 10 ms	No voltage reapplied	30 500	
		t = 8.3 ms		32 000	
		t = 10 ms	100 % V_{RRM} reapplied	25 700	
		t = 8.3 ms		26 900	
Maximum I^2t for fusing	I^2t	t = 10 ms	No voltage reapplied	4651	kA ² s
		t = 8.3 ms		4250	
		t = 10 ms	100 % V_{RRM} reapplied	3300	
		t = 8.3 ms		3000	
Maximum $I^2\sqrt{t}$ for fusing	$I^2\sqrt{t}$	t = 0.1 ms to 10 ms, no voltage reapplied		46 510	kA ² /s
Low level value of threshold voltage	$V_{T(TO)1}$	(16.7 % $\times \pi \times I_{T(AV)} < I < \pi \times I_{T(AV)}$, $T_J = T_J$ maximum)		0.91	V
High level value of threshold voltage	$V_{T(TO)2}$	(I > $\pi \times I_{T(AV)}$, $T_J = T_J$ maximum)		1.01	
Low level value of on-state slope resistance	r_{t1}	(16.7 % $\times \pi \times I_{T(AV)} < I < \pi \times I_{T(AV)}$, $T_J = T_J$ maximum)		0.21	mΩ
High level value of on-state slope resistance	r_{t2}	(I > $\pi \times I_{T(AV)}$, $T_J = T_J$ maximum)		0.19	
Maximum on-state voltage	V_{TM}	$I_{pk} = 4000$ A, $T_J = T_J$ maximum, $t_p = 10$ ms sine pulse		1.73	V
Maximum holding current	I_H	$T_J = 25$ °C, anode supply 12 V resistive load		600	mA
Typical latching current	I_L			1000	

SWITCHING					
PARAMETER	SYMBOL	TEST CONDITIONS		VALUES	UNITS
Maximum non-repetitive rate of rise of turned-on current	di/dt	Gate drive 20 V, 20 Ω, $t_r \leq 1$ μs $T_J = T_J$ maximum, anode voltage ≤ 80 % V_{DRM}		1000	A/μs
Typical delay time	t_d	Gate current 1 A, $di_g/dt = 1$ A/μs $V_d = 0.67$ % V_{DRM} , $T_J = 25$ °C		1.9	μs
Typical turn-off time	t_q	$I_{TM} = 550$ A, $T_J = T_J$ maximum, $di/dt = 40$ A/μs, $V_R = 50$ V, $dV/dt = 20$ V/μs, gate 0 V 100 Ω, $t_p = 500$ μs		200	

BLOCKING					
PARAMETER	SYMBOL	TEST CONDITIONS		VALUES	UNITS
Maximum critical rate of rise of off-state voltage	dV/dt	$T_J = T_J$ maximum linear to 80 % rated V_{DRM}		500	V/μs
Maximum peak reverse and off-state leakage current	I_{RRM} , I_{DRM}	$T_J = T_J$ maximum, rated V_{DRM}/V_{RRM} applied		100	mA



TRIGGERING						
PARAMETER	SYMBOL	TEST CONDITIONS		VALUES		UNITS
				TYP.	MAX.	
Maximum peak gate power	P_{GM}	$T_J = T_J$ maximum, $t_p \leq 5$ ms		16		W
Maximum average gate power	$P_{G(AV)}$	$T_J = T_J$ maximum, $f = 50$ Hz, $d\% = 50$		3		
Maximum peak positive gate current	I_{GM}	$T_J = T_J$ maximum, $t_p \leq 5$ ms		3.0		A
Maximum peak positive gate voltage	$+V_{GM}$			20		
Maximum peak negative gate voltage	$-V_{GM}$			5.0		
DC gate current required to trigger	I_{GT}	$T_J = -40$ °C	Maximum required gate trigger/ current/voltage are the lowest value which will trigger all units 12 V anode to cathode applied	200	-	mA
		$T_J = 25$ °C		100	200	
		$T_J = 125$ °C		50	-	
DC gate voltage required to trigger	V_{GT}	$T_J = -40$ °C		1.4	-	V
		$T_J = 25$ °C		1.1	3.0	
		$T_J = 125$ °C		0.9	-	
DC gate current not to trigger	I_{GD}	$T_J = T_J$ maximum	Maximum gate current/voltage not to trigger is the maximum value which will not trigger any unit with rated V_{DRM} anode to cathode applied	10		mA
DC gate voltage not to trigger	V_{GD}			0.25		

THERMAL AND MECHANICAL SPECIFICATIONS				
PARAMETER	SYMBOL	TEST CONDITIONS	VALUES	UNITS
Maximum operating junction temperature range	T_J		- 40 to 125	°C
Maximum storage temperature range	T_{Stg}		- 40 to 150	
Maximum thermal resistance, junction to heatsink	R_{thJ-hs}	DC operation single side cooled	0.042	K/W
		DC operation double side cooled	0.021	
Maximum thermal resistance, case to heatsink	R_{thC-hs}	DC operation single side cooled	0.006	
		DC operation double side cooled	0.003	
Mounting force, ± 10 %			24 500 (2500)	N (kg)
Approximate weight			425	g
Case style		See dimensions - link at the end of datasheet	A-24 (K-PUK)	

ΔR_{thJC} CONDUCTION						
CONDUCTION ANGLE	SINUSOIDAL CONDUCTION		RECTANGULAR CONDUCTION		TEST CONDITIONS	UNITS
	SINGLE SIDE	DOUBLE SIDE	SINGLE SIDE	DOUBLE SIDE		
180°	0.003	0.003	0.002	0.002	$T_J = T_J$ maximum	K/W
120°	0.004	0.004	0.004	0.004		
90°	0.005	0.005	0.005	0.005		
60°	0.007	0.007	0.007	0.007		
30°	0.012	0.012	0.012	0.012		

Note

- The table above shows the increment of thermal resistance R_{thJC} when devices operate at different conduction angles than DC

ST1200C..KP Series



Vishay High Power Products

Phase Control Thyristors
(Stud Version), 1650 A

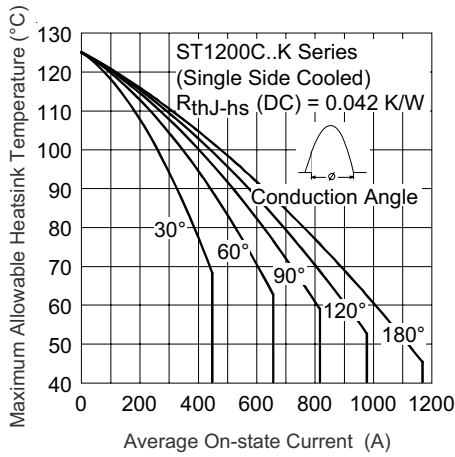

Fig. 1 - Current Ratings Characteristics

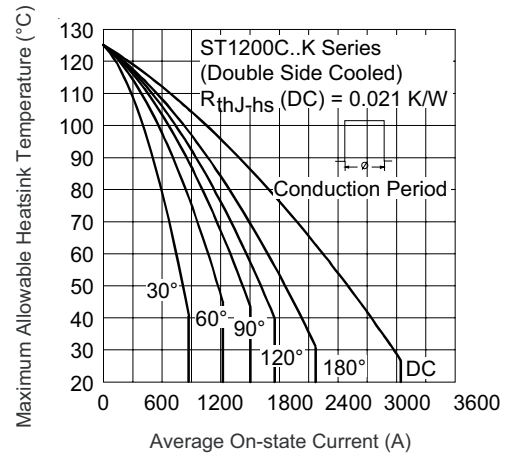

Fig. 4 - Current Ratings Characteristics

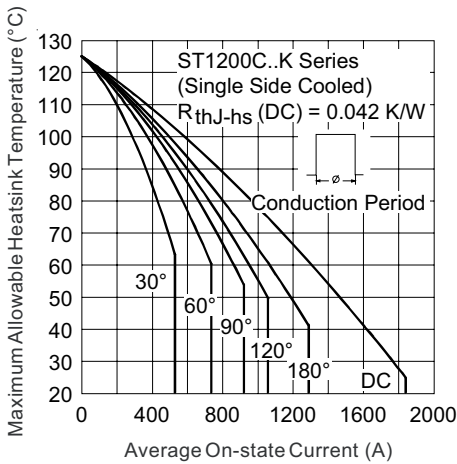

Fig. 2 - Current Ratings Characteristics

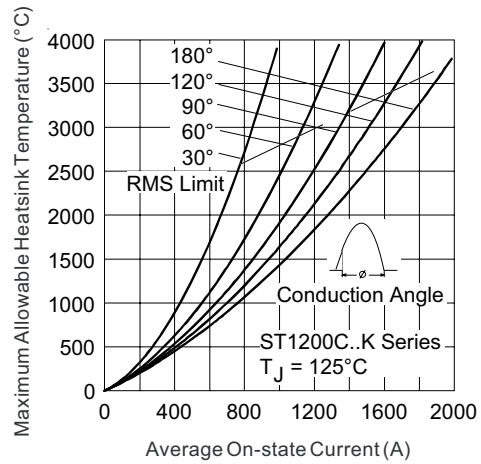

Fig. 5 - On-State Power Loss Characteristics

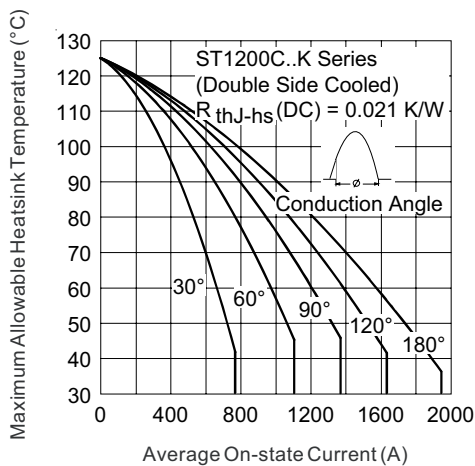

Fig. 3 - Current Ratings Characteristics

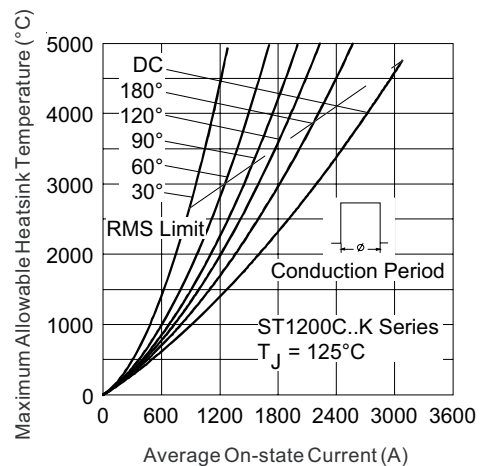

Fig. 6 - On-State Power Loss Characteristics

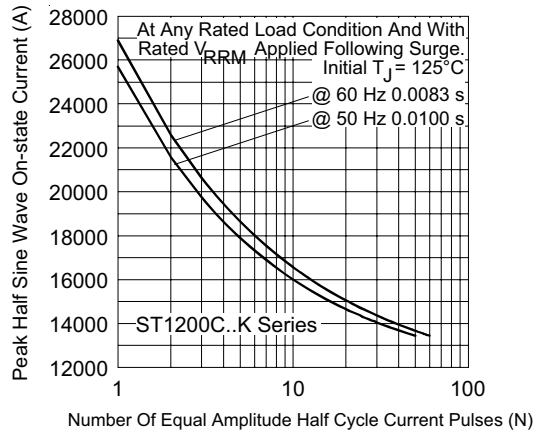

Fig. 7 - Maximum Non-Repetitive Surge Current Single and Double Side Cooled

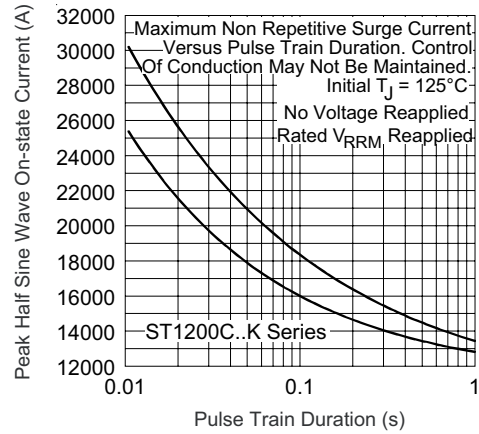

Fig. 8 - Maximum Non-Repetitive Surge Current Single and Double Side Cooled

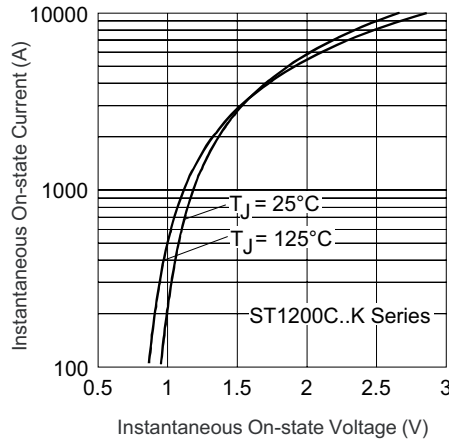

Fig. 9 - On-State Voltage Drop Characteristics

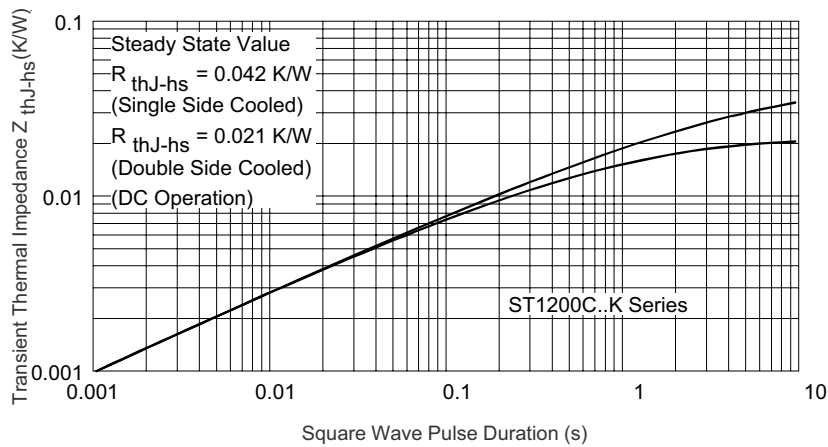

Fig. 10 - Thermal Impedance Z_{thJ-hs} Characteristics

ST1200C..KP Series



Vishay High Power Products Phase Control Thyristors
(Stud Version), 1650 A

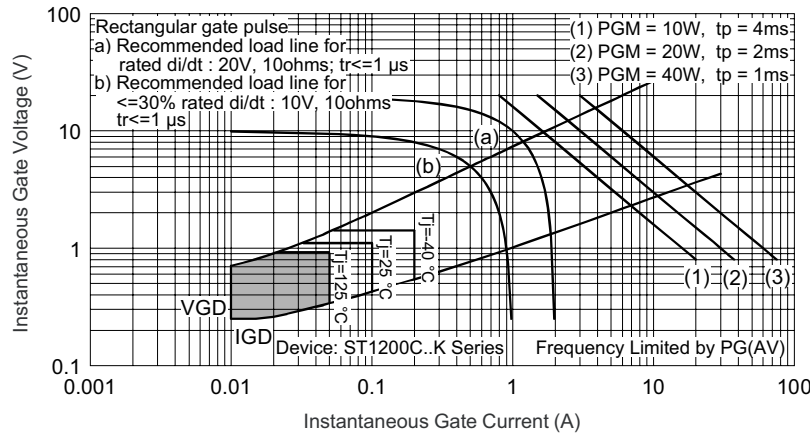

Fig. 11 - Gate Characteristics

ORDERING INFORMATION TABLE

Device code	ST	120	0	C	20	K	1	-	P
	①	②	③	④	⑤	⑥	⑦	⑧	⑨

- 1** - Thyristor
- 2** - Essential part number
- 3** - 0 = Converter grade
- 4** - C = Ceramic PUK
- 5** - Voltage code: Code x 100 = V_{RRM} (see Voltage Ratings table)
- 6** - K = PUK case A-24 (K-PUK)
- 7** - 0 = Eyelet terminals (gate and auxiliary cathode unsoldered leads)
 1 = Fast-on terminals (gate and auxiliary cathode unsoldered leads)
 2 = Eyelet terminals (gate and auxiliary cathode soldered leads)
 3 = Fast-on terminals (gate and auxiliary cathode soldered leads)
- 8** - Critical dV/dt: • None = 500 V/μs (standard selection)
 • L = 1000 V/μs (special selection)
- 9** - P = Lead (Pb)-free

LINKS TO RELATED DOCUMENTS

Dimensions

www.vishay.com/doc?95081

A-24 (K-PUK)

DIMENSIONS in millimeters (inches)

Creepage distance: 28.88 (1.137) minimum
 Strike distance: 17.99 (0.708) minimum



Quote between upper and lower pole pieces has to be considered after application of mounting force (see thermal and mechanical specification)



Disclaimer

ALL PRODUCT, PRODUCT SPECIFICATIONS AND DATA ARE SUBJECT TO CHANGE WITHOUT NOTICE TO IMPROVE RELIABILITY, FUNCTION OR DESIGN OR OTHERWISE.

Vishay Intertechnology, Inc., its affiliates, agents, and employees, and all persons acting on its or their behalf (collectively, "Vishay"), disclaim any and all liability for any errors, inaccuracies or incompleteness contained in any datasheet or in any other disclosure relating to any product.

Vishay makes no warranty, representation or guarantee regarding the suitability of the products for any particular purpose or the continuing production of any product. To the maximum extent permitted by applicable law, Vishay disclaims (i) any and all liability arising out of the application or use of any product, (ii) any and all liability, including without limitation special, consequential or incidental damages, and (iii) any and all implied warranties, including warranties of fitness for particular purpose, non-infringement and merchantability.

Statements regarding the suitability of products for certain types of applications are based on Vishay's knowledge of typical requirements that are often placed on Vishay products in generic applications. Such statements are not binding statements about the suitability of products for a particular application. It is the customer's responsibility to validate that a particular product with the properties described in the product specification is suitable for use in a particular application. Parameters provided in datasheets and/or specifications may vary in different applications and performance may vary over time. All operating parameters, including typical parameters, must be validated for each customer application by the customer's technical experts. Product specifications do not expand or otherwise modify Vishay's terms and conditions of purchase, including but not limited to the warranty expressed therein.

Except as expressly indicated in writing, Vishay products are not designed for use in medical, life-saving, or life-sustaining applications or for any other application in which the failure of the Vishay product could result in personal injury or death. Customers using or selling Vishay products not expressly indicated for use in such applications do so at their own risk and agree to fully indemnify and hold Vishay and its distributors harmless from and against any and all claims, liabilities, expenses and damages arising or resulting in connection with such use or sale, including attorneys fees, even if such claim alleges that Vishay or its distributor was negligent regarding the design or manufacture of the part. Please contact authorized Vishay personnel to obtain written terms and conditions regarding products designed for such applications.

No license, express or implied, by estoppel or otherwise, to any intellectual property rights is granted by this document or by any conduct of Vishay. Product names and markings noted herein may be trademarks of their respective owners.

Material Category Policy

Vishay Intertechnology, Inc. hereby certifies that all its products that are identified as RoHS-Compliant fulfill the definitions and restrictions defined under Directive 2011/65/EU of The European Parliament and of the Council of June 8, 2011 on the restriction of the use of certain hazardous substances in electrical and electronic equipment (EEE) - recast, unless otherwise specified as non-compliant.

Please note that some Vishay documentation may still make reference to RoHS Directive 2002/95/EC. We confirm that all the products identified as being compliant to Directive 2002/95/EC conform to Directive 2011/65/EU.

Компания «Life Electronics» занимается поставками электронных компонентов импортного и отечественного производства от производителей и со складов крупных дистрибьюторов Европы, Америки и Азии.

С конца 2013 года компания активно расширяет линейку поставок компонентов по направлению коаксиальный кабель, кварцевые генераторы и конденсаторы (керамические, пленочные, электролитические), за счёт заключения дистрибьюторских договоров

Мы предлагаем:

- Конкурентоспособные цены и скидки постоянным клиентам.
- Специальные условия для постоянных клиентов.
- Подбор аналогов.
- Поставку компонентов в любых объемах, удовлетворяющих вашим потребностям.
- Приемлемые сроки поставки, возможна ускоренная поставка.
- Доставку товара в любую точку России и стран СНГ.
- Комплексную поставку.
- Работу по проектам и поставку образцов.
- Формирование склада под заказчика.
- Сертификаты соответствия на поставляемую продукцию (по желанию клиента).
- Тестирование поставляемой продукции.
- Поставку компонентов, требующих военную и космическую приемку.
- Входной контроль качества.
- Наличие сертификата ISO.

В составе нашей компании организован Конструкторский отдел, призванный помогать разработчикам, и инженерам.

Конструкторский отдел помогает осуществить:

- Регистрацию проекта у производителя компонентов.
- Техническую поддержку проекта.
- Защиту от снятия компонента с производства.
- Оценку стоимости проекта по компонентам.
- Изготовление тестовой платы монтаж и пусконаладочные работы.



Тел: +7 (812) 336 43 04 (многоканальный)

Email: org@lifeelectronics.ru