

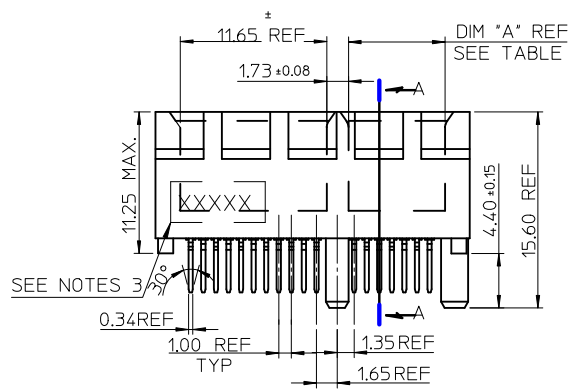

- NOTES:
- 1.MATERIALS:
1-1.HOUSING: SEE TABLE ,GLASS FIBER FILLED UL94V-0, COLOR: SEE TABLE.
1-2.CONTACT: SEE TABLE
 - 2.PLATING:
2-1.CONTACT AREA: GOLD, THICKNESS : SEE TABLE .
2-2.SOLDER TAIL: 100 MICRINCH MIN. TIN PLATING.
2-3.UNDER PLATING: NICKEL PLATING OVERALL.
 - 3.WEEK CODE: XX(YEAR) XXI(WEEK) X(LOCATION),
 - 4.PRODUCT SPECIFICATION REFER TO PS-87715-200.
 - 5.PACKAGING SPECIFICATION REFER TO PK-87715-207.
 - 6.TEST SUMMARY:REFER TO TS-87715-207.
 - 7.LEAD FREE AND ROHS COMPLIANCE PRODUCT.



CONNECTOR LINK WIDTH	# POS REF	N	DIM 'A'	DIM 'B'	DIM 'C'
X1	36	6	7.65	25.00	9.15
X4	64	20	21.65	39.00	23.15
X8	98	37	38.65	56.00	40.15
X16	164	70	71.65	89.00	73.15

PCB THK (REF)	DIM 'D'
1.60	2.30
1.58	2.54
2.36	3.00

REVISED IEC NO: SH2010-0468 DRWNR:ZHANG CHYKD:ALLEN L LIN APPR:X.J.SONG	2010/06/15 2004/07/20 2010/07/02	QUALITY SYMBOLS F=0 E=0 A=0	GENERAL TOLERANCES (UNLESS SPECIFIED)		DIMENSION STYLE MM ONLY		SCALE	DESIGN UNITS	THIRD ANGLE PROJECTION		
			mm	INCH	DRAWN BY		DATE	TITLE			
			4 PLACES ± ---	± ---	TOM		2004/07/20	PCI EXPRESS EDGE CARD CONNECTOR (LEAD FREE VERSION)			
			3 PLACES ± ---	± ---	CHECKED BY		DATE				
2 PLACES ± 0.25	± ---	ALLEN LIN		2004/07/20	MOLEX INCORPORATED						
1 PLACE ± 0.25	± ---	APPROVED BY		DATE							
ANGULAR ± 3 °			WILSON		2004/07/20	DOCUMENT NO.		SHEET NO.			
DRAFT WHERE APPLICABLE MUST REMAIN WITHIN DIMENSIONS			SEE SHEET 4		SD-87715-207		1 OF 4				
THIS DRAWING CONTAINS INFORMATION THAT IS PROPRIETARY TO MOLEX INCORPORATED AND SHOULD NOT BE USED WITHOUT WRITTEN PERMISSION											

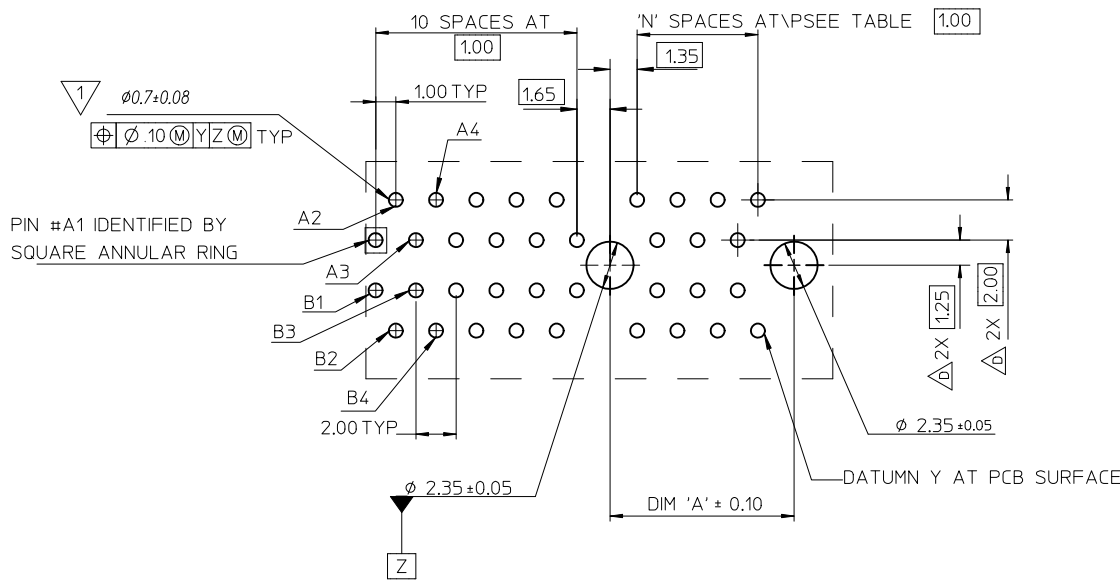

1 THE HORIZONTAL AXIS FOR THE HOLE PATTERN IS ESTABLISHED BY A LINE THROUGH THE CENTER OF THE TWO $\phi 2.35$ HOLES. THE VERTICAL AXIS IS 90° TO THE HORIZONTAL AXIS, THROUGH THE CENTER OF DATUM Z

CONNECTOR LINK WIDTH	# POS REF	N	DIM 'A'
X1	36	6	9.15
X4	64	20	23.15
X8	98	37	40.15
X16	164	70	73.15

SEE SHEET 1 EC NO: SH2010-0468 DRW: RZHANG 2010/06/15 CHKD: ALLEN LIN 2004/07/20 APPR: XJSONG 2010/07/02	QUALITY SYMBOLS	GENERAL TOLERANCES (UNLESS SPECIFIED)	DIMENSION STYLE MM ONLY	SCALE	DESIGN UNITS METRIC	THIRD ANGLE PROJECTION																														
	$F_A=0$ $F_G=0$ $F_P=0$	<table border="1"> <thead> <tr> <th></th> <th>mm</th> <th>INCH</th> </tr> </thead> <tbody> <tr> <td>4 PLACES</td> <td>± ---</td> <td>± ---</td> </tr> <tr> <td>3 PLACES</td> <td>± ---</td> <td>± ---</td> </tr> <tr> <td>2 PLACES</td> <td>± 0.25</td> <td>± ---</td> </tr> <tr> <td>1 PLACE</td> <td>± 0.25</td> <td>± ---</td> </tr> </tbody> </table>		mm	INCH	4 PLACES	± ---	± ---	3 PLACES	± ---	± ---	2 PLACES	± 0.25	± ---	1 PLACE	± 0.25	± ---	<table border="1"> <thead> <tr> <th></th> <th>mm</th> <th>INCH</th> </tr> </thead> <tbody> <tr> <td>4 PLACES</td> <td>± ---</td> <td>± ---</td> </tr> <tr> <td>3 PLACES</td> <td>± ---</td> <td>± ---</td> </tr> <tr> <td>2 PLACES</td> <td>± 0.25</td> <td>± ---</td> </tr> <tr> <td>1 PLACE</td> <td>± 0.25</td> <td>± ---</td> </tr> </tbody> </table>		mm	INCH	4 PLACES	± ---	± ---	3 PLACES	± ---	± ---	2 PLACES	± 0.25	± ---	1 PLACE	± 0.25	± ---	DRAWN BY: TOM DATE: 2004/07/20 CHECKED BY: ALLEN LIN DATE: 2004/07/20 APPROVED BY: WILSON DATE: 2004/07/20	TITLE	PCI EXPRESS EDGE CARD CONNECTOR (LEAD FREE VERSION)
		mm	INCH																																	
	4 PLACES	± ---	± ---																																	
3 PLACES	± ---	± ---																																		
2 PLACES	± 0.25	± ---																																		
1 PLACE	± 0.25	± ---																																		
	mm	INCH																																		
4 PLACES	± ---	± ---																																		
3 PLACES	± ---	± ---																																		
2 PLACES	± 0.25	± ---																																		
1 PLACE	± 0.25	± ---																																		
DRAFT WHERE APPLICABLE MUST REMAIN WITHIN DIMENSIONS	ANGULAR ± 3°	MATERIAL NO.	SEE SHEET 4	DOCUMENT NO.	MOLEX INCORPORATED																															
		SIZE A3	THIS DRAWING CONTAINS INFORMATION THAT IS PROPRIETARY TO MOLEX INCORPORATED AND SHOULD NOT BE USED WITHOUT WRITTEN PERMISSION		SHEET NO. 2 OF 4																															



← I/O PANEL DIRECTION

PRIMARY (COMPONENT) SIDE

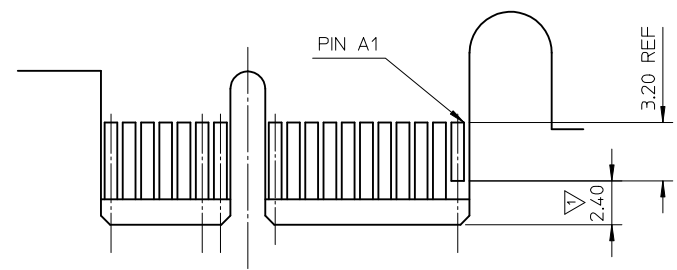

I/O PANEL DIRECTION →

SECONDARY (SOLDER) SIDE

- 1 NO TIE BAR PERMITTED FROM CARD EDGE TO LEADING EDGE OF PAD FOR PINS A1 AND "C".
- 2 CHAMFER EDGES MUST BE FREE OF CUTTING BURRS.
- 3. TOLERANCE: .XX±.13

CONNECTOR LINK WIDTH	# POS REF	N	DIM 'B'	'C'
X1	36	6	8.15	B17
X4	64	20	22.15	B17, B31
X8	98	37	39.15	B17, B31 B48
X16	164	70	72.15	B17, B31 B48, B81

SEE SHEET 1 EC NO: SH2010-0468 DRWR: ZHANG 2010/06/15 CHKD: ALLEN LIN 2004/07/20 APPR: XJ.SONG 2010/07/02	QUALITY SYMBOLS	GENERAL TOLERANCES (UNLESS SPECIFIED)		DIMENSION STYLE	SCALE	DESIGN UNITS	THIRD ANGLE PROJECTION
	$\nabla_{\text{A}}=0$	mm	INCH	MM ONLY		METRIC	
	$\nabla_{\text{B}}=0$	4 PLACES ± --- ± ---		DRAWN BY	DATE	TITLE	
	$\nabla_{\text{C}}=0$	3 PLACES ± --- ± ---		TOM	2004/07/20	PCI EXPRESS EDGE CARD CONNECTOR (LEAD FREE VERSION)	
	2 PLACES ± 0.25 ± ---		CHECKED BY	DATE	MOLEX INCORPORATED		
	1 PLACE ± 0.25 ± ---		ALLEN LIN	2004/07/20		MATERIAL NO. SEE SHEET 4	DOCUMENT NO. SD-87715-207
	ANGULAR ± 3°		APPROVED BY	DATE	SHEET NO. 3 OF 4		
			WILSON	2004/07/20			
			DRAFT WHERE APPLICABLE MUST REMAIN WITHIN DIMENSIONS		THIS DRAWING CONTAINS INFORMATION THAT IS PROPRIETARY TO MOLEX INCORPORATED AND SHOULD NOT BE USED WITHOUT WRITTEN PERMISSION		

MOLEX P/N	CIRCUIT SIZE	HOUSING MATERIAL	HOUSING COLOR	TERMINAL MATERIAL	CONTACT PLATING	SOLDER TAIL 'D' LENGTH	
87715-9001	36	NYLON46	BLACK	PHOSPHOR BRONZE	10 MICROINCH	2.54	
87715-9003					GOLD FLASH		
87715-9004					10 MICROINCH	3.00	
87715-9007					GOLD FLASH		
87715-9008					15 MICROINCH		2.30

MOLEX P/N	CIRCUIT SIZE	HOUSING MATERIAL	HOUSING COLOR	TERMINAL MATERIAL	CONTACT PLATING	SOLDER TAIL 'D' LENGTH
87715-9100	64	NYLON46	BLACK	PHOSPHOR BRONZE	GOLD FLASH	2.54
87715-9101					10 MICROINCH	
87715-9102					15 MICROINCH	3.00
87715-9103					GOLD FLASH	
87715-9104					10 MICROINCH	
87715-9105					15 MICROINCH	
87715-9106					30 MICROINCH	2.54
87715-9107					GOLD FLASH	2.30
87715-9108					15 MICROINCH	
87715-9109					30 MICROINCH	

MOLEX P/N	CIRCUIT SIZE	HOUSING MATERIAL	HOUSING COLOR	TERMINAL MATERIAL	CONTACT PLATING	SOLDER TAIL 'D' LENGTH
87715-9200	98	NYLON46	BLACK	PHOSPHOR BRONZE	GOLD FLASH	2.54
87715-9201					10 MICROINCH	
87715-9202					15 MICROINCH	3.00
87715-9203					GOLD FLASH	
87715-9204					10 MICROINCH	
87715-9205					15 MICROINCH	
87715-9206					30 MICROINCH	2.54
87715-9207					GOLD FLASH	2.30
87715-9208					15 MICROINCH	
87715-9209					30 MICROINCH	

MOLEX P/N	CIRCUIT SIZE	HOUSING MATERIAL	HOUSING COLOR	TERMINAL MATERIAL	CONTACT PLATING	SOLDER TAIL 'D' LENGTH
87715-9602	98	NYLON46	BLACK	BRASS	15 MICROINCH	2.54

MOLEX P/N	CIRCUIT SIZE	HOUSING MATERIAL	HOUSING COLOR	TERMINAL MATERIAL	CONTACT PLATING	SOLDER TAIL 'D' LENGTH
87715-9301	164	NYLON46	BLACK	PHOSPHOR BRONZE	10 MICROINCH	2.54
87715-9304						3.00
87715-9307					GOLD FLASH	2.30
87715-9308					15 MICROINCH	

SEE SHEET 1 EC NO: SH2010-0468 DRW:RZHANG 2010/06/15 CHKD:ALLEN LIN 2004/07/20 APPR:XJ.SONG 2010/07/02	QUALITY SYMBOLS	GENERAL TOLERANCES (UNLESS SPECIFIED)		DIMENSION STYLE MM ONLY		SCALE	DESIGN UNITS METRIC	THIRD ANGLE PROJECTION
	$F_A=0$	4 PLACES	mm	INCH	DRAWN BY	DATE	TITLE	
	$F_C=0$	3 PLACES	± ---	± ---	TOM	2004/07/20	PCI EXPRESS	
	$F_B=0$	2 PLACES	± 0.25	± ---	CHECKED BY	DATE	EDGE CARD CONNECTOR (LEAD FREE VERSION)	
	1 PLACE	± 0.25	± ---	ALLEN LIN	2004/07/20	MOLEX INCORPORATED		
		ANGULAR ± 3 °		APPROVED BY	DATE	DOCUMENT NO.		
		DRAFT WHERE APPLICABLE MUST REMAIN WITHIN DIMENSIONS		WILSON	2004/07/20	SD-87715-207		
				MATERIAL NO.		SHEET NO.		
				SIZE A3	THIS DRAWING CONTAINS INFORMATION THAT IS PROPRIETARY TO MOLEX INCORPORATED AND SHOULD NOT BE USED WITHOUT WRITTEN PERMISSION			4 OF 4

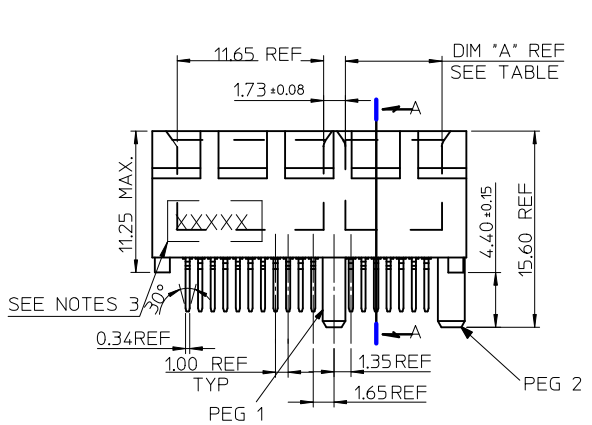
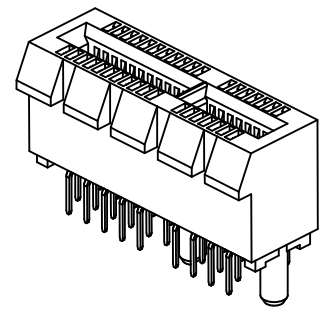

- NOTES:
 1.MATERIALS:
 1-1.HOUSING: SEE TABLE ,GLASS FIBER FILLED UL94V-0, COLOR: SEE TABLE.
 1-2.CONTACT: SEE TABLE
 2.PLATING:
 2-1.CONTACT AREA: GOLD, THICKNESS : SEE TABLE .
 2-2.SOLDER TAIL: 100 MICRONCH MIN. TIN PLATING.
 2-3.UNDER PLATING: NICKEL PLATING OVERALL.
 3.DATE CODE: YY MM DD.
 4.PRODUCT SPECIFICATION REFER TO PS-87715-200.
 5.TEST SUMMARY:REFER TO TS-87715-207.

CONNECTOR LINK WIDTH	# POS REF	N	DIM 'A'	DIM 'B'	DIM 'C'
X1	36	6	7.65	25.00	9.15
X16	164	70	71.65	89.00	73.15

PCB THK (REF)	DIM 'D'
1.58	2.54
2.36	3.00

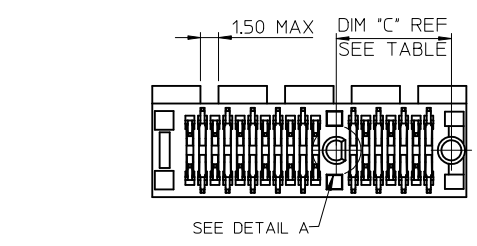

REVISED	EC NO: SH2011-0358	2011/06/02
	DRWN:FYANG05	2011/06/02
	CHKD:	
	APPR:RZHANG	2011/06/07
REV	DESCRIPTION	

QUALITY SYMBOLS	GENERAL TOLERANCES (UNLESS SPECIFIED)	
	mm	INCH
$\nabla = 0$	4 PLACES \pm ---	\pm ---
$\nabla = 0$	3 PLACES \pm ---	\pm ---
$\nabla = 0$	2 PLACES \pm 0.25	\pm ---
	1 PLACE \pm 0.25	\pm ---
	ANGULAR \pm 3°	
	DRAFT WHERE APPLICABLE MUST REMAIN WITHIN DIMENSIONS	

DIMENSION STYLE		SCALE	DESIGN UNITS	THIRD ANGLE PROJECTION
MM ONLY			METRIC	
DRAWN BY	DATE	TITLE		
DAVID HU	2007/05/14	PCI EXPRESS EDGE CARD CONNECTOR (LEAD FREE VERSION)		
CHECKED BY	DATE			
HARVEY	2007/05/14	Molex MOLEX INCORPORATED		
APPROVED BY	DATE			
JENNY CHEN	2007/05/14	MATERIAL NO.	DOCUMENT NO.	SHEET NO.
		SEE SHEET 4	SD-87715-901	1 OF 4



1 THE HORIZONTAL AXIS FOR THE HOLE PATTERN IS ESTABLISHED BY A LINE THROUGH THE CENTER OF THE TWO $\phi 2.35$ HOLES. THE VERTICAL AXIS IS 90° TO THE HORIZONTAL AXIS, THROUGH THE CENTER OF DATUM Z

CONNECTOR LINK WIDTH	# POS REF	N	DIM 'A'
X1	36	6	9.15
X16	164	70	73.15

SEE SHEET 1 EC NO: SH2011-0358 DRWN: YANG05 CHKD: APPR: RZHANG REV	QUALITY SYMBOLS	GENERAL TOLERANCES (UNLESS SPECIFIED)	DIMENSION STYLE	SCALE	DESIGN UNITS	THIRD ANGLE PROJECTION	
	$F_A=0$ $F_C=0$ $F_P=0$	mm INCH 4 PLACES ± --- ± --- 3 PLACES ± --- ± --- 2 PLACES ± 0.25 ± --- 1 PLACE ± 0.25 ± --- ANGULAR ± 3°	MM ONLY	DRAWN BY DATE DAVID HU 2007/05/14 CHECKED BY DATE HARVEY 2007/05/14 APPROVED BY DATE JENNY CHEN 2007/05/14 MATERIAL NO.	TITLE	PCI EXPRESS EDGE CARD CONNECTOR (LEAD FREE VERSION)	MOLEX INCORPORATED DOCUMENT NO. SD-87715-901 SHEET NO. 2 OF 4
	DRAFT WHERE APPLICABLE MUST REMAIN WITHIN DIMENSIONS	SEE SHEET 1	THIS DRAWING CONTAINS INFORMATION THAT IS PROPRIETARY TO MOLEX INCORPORATED AND SHOULD NOT BE USED WITHOUT WRITTEN PERMISSION				



← I/O PANEL DIRECTION

PRIMARY (COMPONENT) SIDE

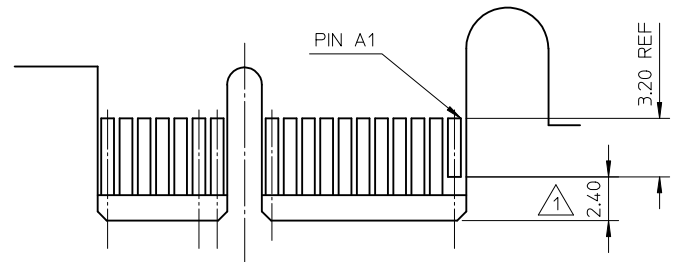

I/O PANEL DIRECTION →

SECONDARY (SOLDER) SIDE

- ① NO TIE BAR PERMITTED FROM CARD EDGE TO LEADING EDGE OF PAD FOR PINS A1 AND "C".
- ② CHAMFER EDGES MUST BE FREE OF CUTTING BURRS.
- ③ TOLERANCE: .XX±.13

CONNECTOR LINK WIDTH	# POS REF	N	DIM 'B'	'C' ①
X1	36	6	8.15	B17
X16	164	70	72.15	B17, B31 B48, B81

SEE SHEET 1 EC NO: SH2011-0358 DRWN: YANG05 CHKD: APPR: RZHANG	2011/06/02 2011/06/07	QUALITY SYMBOLS	GENERAL TOLERANCES (UNLESS SPECIFIED)	DIMENSION STYLE	SCALE	DESIGN UNITS	THIRD ANGLE PROJECTION																													
		$F_A = 0$ $F_C = 0$ $F_B = 0$	<table border="1"> <tr> <th></th> <th>mm</th> <th>INCH</th> </tr> <tr> <td>4 PLACES</td> <td>± ---</td> <td>± ---</td> </tr> <tr> <td>3 PLACES</td> <td>± ---</td> <td>± ---</td> </tr> <tr> <td>2 PLACES</td> <td>± 0.25</td> <td>± ---</td> </tr> <tr> <td>1 PLACE</td> <td>± 0.25</td> <td>± ---</td> </tr> </table>		mm	INCH	4 PLACES	± ---	± ---	3 PLACES	± ---	± ---	2 PLACES	± 0.25	± ---	1 PLACE	± 0.25	± ---	MM ONLY	METRIC	<table border="1"> <tr> <th>DRAWN BY</th> <th>DATE</th> <th>TITLE</th> </tr> <tr> <td>DAVID HU</td> <td>2007/05/14</td> <td rowspan="3">PCI EXPRESS EDGE CARD CONNECTOR (LEAD FREE VERSION)</td> </tr> <tr> <th>CHECKED BY</th> <th>DATE</th> </tr> <tr> <td>HARVEY</td> <td>2007/05/14</td> </tr> <tr> <th>APPROVED BY</th> <th>DATE</th> <td rowspan="2"> MOLEX INCORPORATED </td> </tr> <tr> <td>JENNY CHEN</td> <td>2007/05/14</td> </tr> </table>	DRAWN BY	DATE	TITLE	DAVID HU	2007/05/14	PCI EXPRESS EDGE CARD CONNECTOR (LEAD FREE VERSION)	CHECKED BY	DATE	HARVEY	2007/05/14	APPROVED BY	DATE	MOLEX INCORPORATED	JENNY CHEN	2007/05/14
			mm	INCH																																
		4 PLACES	± ---	± ---																																
3 PLACES	± ---	± ---																																		
2 PLACES	± 0.25	± ---																																		
1 PLACE	± 0.25	± ---																																		
DRAWN BY	DATE	TITLE																																		
DAVID HU	2007/05/14	PCI EXPRESS EDGE CARD CONNECTOR (LEAD FREE VERSION)																																		
CHECKED BY	DATE																																			
HARVEY	2007/05/14																																			
APPROVED BY	DATE	MOLEX INCORPORATED																																		
JENNY CHEN	2007/05/14																																			
<table border="1"> <tr> <th>SIZE</th> <td>A3</td> </tr> </table>	SIZE	A3	MATERIAL NO. SEE SHEET 1	DOCUMENT NO. SD-87715-901	SHEET NO. 3 OF 4																															
SIZE	A3																																			
DRAFT WHERE APPLICABLE MUST REMAIN WITHIN DIMENSIONS THIS DRAWING CONTAINS INFORMATION THAT IS PROPRIETARY TO MOLEX INCORPORATED AND SHOULD NOT BE USED WITHOUT WRITTEN PERMISSION																																				

10 9 8 7 6 5 4 3 2 1



MOLEX P/N	CIRCUIT SIZE	HOUSING MATERIAL	HOUSING COLOR	TERMINAL MATERIAL	CONTACT PLATING	SOLDER TAIL 'D' LENGTH	PEG 1	PEG 2	DESCRIPTION
87715-9000	36	NYLON46	BLACK	PHOSPHOR BRONZE	GOLD FLASH	2.54	WITH	WITH	TOOLED
87715-9002					15 MICROINCH				
87715-9005					15 MICROINCH	3.00			
87715-9006					30 MICROINCH				
87715-9009					30 MICROINCH				



MOLEX P/N	CIRCUIT SIZE	HOUSING MATERIAL	HOUSING COLOR	TERMINAL MATERIAL	CONTACT PLATING	SOLDER TAIL 'D' LENGTH	PEG 1	PEG 2	DESCRIPTION
87715-9300	164	NYLON46	BLACK	PHOSPHOR BRONZE	GOLD FLASH	2.54	WITH	WITH	TOOLED
87715-9302					15 MICROINCH				
87715-9303					GOLD FLASH	3.00			
87715-9305					15 MICROINCH				
87715-9306					30 MICROINCH				
87715-9309					30 MICROINCH	3.00			

SEE SHEET 1 EC NO: SH2011-0358 DRAWN: FANG05 CHK'D: APPR: RZHANG 2011/06/02 2011/06/07	QUALITY SYMBOLS	GENERAL TOLERANCES (UNLESS SPECIFIED)	DIMENSION STYLE	SCALE	DESIGN UNITS	THIRD ANGLE PROJECTION	
	$F_A=0$ $F_C=0$ $F_P=0$	mm INCH 4 PLACES ± --- ± --- 3 PLACES ± --- ± --- 2 PLACES ± 0.25 ± --- 1 PLACE ± 0.25 ± --- ANGULAR ± 3 °	MM ONLY	DRAWN BY DATE DAVID HU 2007/05/14 CHECKED BY DATE HARVEY 2007/05/14 APPROVED BY DATE JENNY CHEN 2007/05/14	TITLE	PCI EXPRESS EDGE CARD CONNECTOR (LEAD FREE VERSION)	MOLEX INCORPORATED
	DRAFT WHERE APPLICABLE MUST REMAIN WITHIN DIMENSIONS	SEE SHEET 1	MATERIAL NO.	DOCUMENT NO.	SHEET NO.		
				SIZE A3	THIS DRAWING CONTAINS INFORMATION THAT IS PROPRIETARY TO MOLEX INCORPORATED AND SHOULD NOT BE USED WITHOUT WRITTEN PERMISSION		

9 8 7 6 5 4 3 2 1

Компания «Life Electronics» занимается поставками электронных компонентов импортного и отечественного производства от производителей и со складов крупных дистрибьюторов Европы, Америки и Азии.

С конца 2013 года компания активно расширяет линейку поставок компонентов по направлению коаксиальный кабель, кварцевые генераторы и конденсаторы (керамические, пленочные, электролитические), за счёт заключения дистрибьюторских договоров

Мы предлагаем:

- Конкуренспособные цены и скидки постоянным клиентам.
- Специальные условия для постоянных клиентов.
- Подбор аналогов.
- Поставку компонентов в любых объемах, удовлетворяющих вашим потребностям.
- Приемлемые сроки поставки, возможна ускоренная поставка.
- Доставку товара в любую точку России и стран СНГ.
- Комплексную поставку.
- Работу по проектам и поставку образцов.
- Формирование склада под заказчика.
- Сертификаты соответствия на поставляемую продукцию (по желанию клиента).
- Тестирование поставляемой продукции.
- Поставку компонентов, требующих военную и космическую приемку.
- Входной контроль качества.
- Наличие сертификата ISO.

В составе нашей компании организован Конструкторский отдел, призванный помогать разработчикам, и инженерам.

Конструкторский отдел помогает осуществить:

- Регистрацию проекта у производителя компонентов.
- Техническую поддержку проекта.
- Защиту от снятия компонента с производства.
- Оценку стоимости проекта по компонентам.
- Изготовление тестовой платы монтаж и пусконаладочные работы.



Тел: +7 (812) 336 43 04 (многоканальный)

Email: org@lifeelectronics.ru