

# POLYSWITCH RESETTABLE DEVICES

## Surface-Mount Devices

PolySwitch surface-mount devices are an effective circuit protection method for computer, consumer, multimedia, portable and automotive electronics applications.

In an effort to reduce the size and cost of surface-mount devices, Littelfuse PolySwitch team introduced the miniSMD product series in 1995. Subsequently, we developed the microSMD, nanoSMD, picoSMD and femtoSMD family of products. The femtoSMD series reduced the device size to a 1608mm (0603 mils) footprint, which is one-twelfth the size of the popular miniSMD series.

Recent additions to the PolySwitch surface-mount series include 1.1A picoSMD 1210mm (0805 mils) and 0.35A femtoSMD 1608mm (0603 mils) devices.

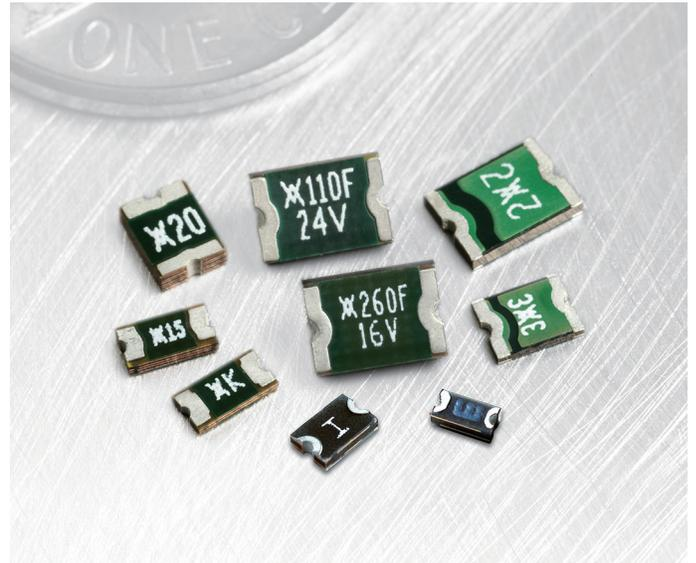

### BENEFITS

- Smaller size helps save board space and cost
- Many product choices optimizes design flexibility
- Compatible with high-volume electronics assembly
- Assists in meeting regulatory requirements
- Higher voltage ratings allow use in new applications

### FEATURES

- RoHS compliant
- Halogen free  
(refers to: Br $\geq$ 900ppm, Cl $\geq$ 900ppm, Br+Cl $\geq$ 1500ppm)
- Broadest range of resettable devices available in the industry
- Current ratings from 0.05 to 3.1A
- Voltage ratings from 6V computer and electronic applications to 60V telecom applications
- Agency recognition: UL, CSA, TÜV
- Small footprint
- Fast time-to-trip
- Low resistance

### APPLICATIONS

- Computer
- Portable electronics
- Multimedia
- Game machines
- Telephony and broadband
- Mobile phones
- Automotive
- Industrial controls
- Battery

# PolySwitch Resettable Devices

## Surface-Mount Devices

### Application Selection Table

- The table below lists PolySwitch surface-mount devices recommended for use in typical applications
- Specifications for the suggested PolySwitch surface-mount device part numbers can be found in this table
- Once a part has been selected, the user should evaluate and test each product for the intended application

			PolySwitch Resettable Devices - Key Selection Criteria		
Protection Application	Additional Comments	Overcurrent Overvoltage	Small Size	Low Resistance	Fast Time-to-trip (Temperature Protection)
AC Adapter Input Power	Use w/ Zener & Triac		SMD250F	SMD250F	SMD200F
Battery Pack Protection			nanoSMDC150F	miniSMDC260F	miniSMDE200F/16
Charger Protection			nanoSMDC050F	miniSMDC110F/16	nanoSMDC075F
CPU/IC Protection			nanoSMDC110F	nanoSMDC150F	nanoSMDC075F
Data Acquisition/Sensor			microSMD005F	—	microSMD005F
DC Input/Output Power	≤6V		nanoSMDC075F	nanoSMDC150F	nanoSMDC050F/13.2
	≤12V		miniSMDC075F	miniSMDC110F/16	miniSMDC075F
DDC			nanoSMDC075F	nanoSMDC110F	nanoSMDC050F/13.2
Device Bay System	DB12, DB20		miniSMDC200F	miniSMDC260F	miniSMDC200F
	DB32		miniSMDC260F	SMD300F	miniSMDC200F
Ethernet/LAN			nanoSMDC050F/13.2	miniSMDC110F/16	nanoSMDC075F
Fan			microSMD035F	microSMD050F	microSMD035F
HDMI			picoSMDC035S	picoSMDC035S	picoSMDC035S
IEEE 802.3af	VoIP		decaSMDC050F/60	decaSMDC050F/60	decaSMDC050F/60
IEEE-1394	Power Provider		SMD100F/33	SMD185F	SMD100F/33
	Alt. Power Provider		SMD185F	SMD185F	SMD150F/33
	Self-Powered		SMD185F	SMD185F	SMD150F/33
LCD Inverter			nanoSMDC050F/13.2	miniSMDC110F/16	nanoSMDC075F
LCD Screen Power			nanoSMDC050F/13.2	nanoSMDC050F/13.2	microSMD035F
LNB (Low Noise Block)			SMD075F	SMD075F	SMD050F
Motor	≤6V		nanoSMDC110F	nanoSMDC150F	microSMD075F
	≤13.2V		miniSMDC075F	miniSMDC110F/16	miniSMDC075F
PS/2 Mouse/Keyboard			nanoSMDC075F	nanoSMDC110F	nanoSMDC050F/13.2
Signal - Data Communication	≤6V		nanoSMDC075F	nanoSMDC075F	nanoSMDC075F
	≤13.2V		miniSMDC050F	miniSMDC075F	miniSMDC020F
	≤30V		SMD030F-2018	SMD075F	SMD050F
SCSI			nanoSMDC110F	nanoSMDC150F	nanoSMDC075F
SIM/Smart Card Reader			femtoSMDC010F	femtoSMDC010F	femtoSMDC005F
Telecom - Modem	Digital Line	OC	miniSMDC014F	miniSMDC014F	miniSMDC014F
Telecom - PBX	Subscriber	OC	miniSMDC014F	miniSMDC014F	miniSMDC014F
Temperature Sensor	CPU		nanoSMDC050F/13.2	nanoSMDC075F	nanoSMDC050F/13.2
USB	Individual Port		nanoSMDC075F	nanoSMDC110F	nanoSMDC050F/13.2
	2 Port Ganged		nanoSMDC150F	miniSMDC150F	miniSMDC125F
	3 Port Ganged		miniSMDC200F	miniSMDC200F	miniSMDC200F

**Note:** This list is not exhaustive. Littelfuse welcomes our customers' input for additional application ideas for PolySwitch resettable devices.

# PolySwitch Resettable Devices

## Surface-Mount Devices

Table S1 — Product Series: Size, Current Rating, Voltage Rating/Maximum Resistance

	femtoSMD	picoSMD	nanoSMD	microSMD	miniSMD	midSMD
<b>Size mm</b>	1608	2012	3216	3225	4532	5050
<b>(mils)</b>	(0603)	(0805)	(1206)	(1210)	(1812)	(2018)
<b>Hold Current (A)</b>						
0.050	15V <sub>DC</sub> /30.00Ω	—	—	30V <sub>DC</sub> /50Ω	—	—
0.080	12V <sub>DC</sub> /14.00Ω	—	—	—	—	—
0.100	12V <sub>DC</sub> /8.00Ω	15V <sub>DC</sub> /11.00Ω	60V <sub>DC</sub> /15.00Ω	30V <sub>DC</sub> /15Ω	60V <sub>DC</sub> /12.70Ω	—
	—	—	—	—	—	—
0.120	9V <sub>DC</sub> /5.80Ω	15V <sub>DC</sub> /9.00Ω	48V <sub>DC</sub> /6.50Ω	—	—	—
0.140	—	—	—	—	60V <sub>DC</sub> /6.00Ω	—
0.160	9V <sub>DC</sub> /4.20Ω	—	48V <sub>DC</sub> /5.00Ω	—	—	—
0.200	9V <sub>DC</sub> /3.00Ω	9V <sub>DC</sub> /3.20Ω	24V <sub>DC</sub> /3.10Ω	—	30V <sub>DC</sub> /3.30Ω	—
0.250	—	—	16V <sub>DC</sub> /2.10Ω	—	—	—
0.300	—	—	—	—	30V <sub>DC</sub> /1.75Ω	60V <sub>DC</sub> /2.30Ω
0.350	6V <sub>DC</sub> /1.00Ω	6V <sub>DC</sub> /1.40Ω	16V <sub>DC</sub> /1.35Ω	6V <sub>DC</sub> /1.30Ω	—	—
0.500	—	6V <sub>DC</sub> /0.80Ω	13.2V <sub>DC</sub> /0.75Ω	13.2V <sub>DC</sub> /0.90Ω	24V <sub>DC</sub> /1.00Ω	—
0.750	—	6V <sub>DC</sub> /0.35Ω*	6V <sub>DC</sub> /0.30Ω	6V <sub>DC</sub> /0.40Ω	13.2V <sub>DC</sub> /0.45Ω	—
	—	—	—	—	24V <sub>DC</sub> /0.29Ω	—
	—	—	—	—	33V <sub>DC</sub> /0.39Ω	—
1.000	—	—	—	—	—	15V <sub>DC</sub> /0.40Ω
	—	—	—	—	—	—
1.100	—	6V <sub>DC</sub> /0.17Ω*	6V <sub>DC</sub> /0.20Ω	6V <sub>DC</sub> /0.21Ω	8V <sub>DC</sub> /0.21Ω	—
	—	—	—	—	16V <sub>DC</sub> /0.18Ω	—
	—	—	—	—	24V <sub>DC</sub> /0.18Ω	—
1.200	—	—	—	—	—	—
1.250	—	—	—	—	6V <sub>DC</sub> /0.14Ω	—
	—	—	—	—	16V <sub>DC</sub> /0.14Ω	—
1.500	—	—	6V <sub>DC</sub> /0.11Ω	6V <sub>DC</sub> /0.11Ω	6V <sub>DC</sub> /0.11Ω	15V <sub>DC</sub> /0.18Ω
	—	—	—	—	12V <sub>DC</sub> /0.11Ω	—
	—	—	—	—	16V <sub>DC</sub> /0.11Ω	—
	—	—	—	—	24V <sub>DC</sub> /0.12Ω	—
1.600	—	—	—	—	9V <sub>DC</sub> /0.10Ω	—
1.750	—	—	—	6V <sub>DC</sub> /0.08Ω	—	—
1.850	—	—	—	—	—	—
2.000	—	—	6V <sub>DC</sub> /0.072Ω	6V <sub>DC</sub> /0.06Ω	8V <sub>DC</sub> /0.07Ω	6V <sub>DC</sub> /0.10Ω
	—	—	—	—	16V <sub>DC</sub> /0.085Ω	—
2.500	—	—	—	—	—	—
2.600	—	—	—	—	6V <sub>DC</sub> /0.043Ω	—
	—	—	—	—	12V <sub>DC</sub> /0.047Ω	—
	—	—	—	—	13.2V <sub>DC</sub> /0.050Ω	—
	—	—	—	—	16V <sub>DC</sub> /0.050Ω	—
3.000	—	—	—	—	6V <sub>DC</sub> /0.036Ω	—
	—	—	—	—	—	—
3.100	—	—	—	—	—	—

# PolySwitch Resettable Devices

## Surface-Mount Devices

**Table S1 — Product Series: Size, Current Rating, Voltage Rating/Maximum Resistance**  
(Cont'd)

	SMDC	SMD	SMD2	decaSMD	High Temperature SMD
<b>Size mm</b>	7555	7555	8763	5050	3216 & 3225
<b>(mils)</b>	(2920)	(2920)	(3425)	(2018)	(1206) & (1210)
<b>Hold Current (A)</b>					
0.050	—	—	—	—	—
0.080	—	—	—	—	—
0.100	—	—	—	—	30V <sub>DC</sub> /10.0Ω
	—	—	—	—	30V <sub>DC</sub> /11.0Ω
0.120	—	—	—	—	—
0.140	—	—	—	—	—
0.160	—	—	—	—	—
0.200	—	—	—	—	—
0.250	—	—	—	—	—
0.300	—	60V <sub>DC</sub> /4.80Ω	—	—	—
0.350	—	—	—	—	—
0.500	—	60V <sub>DC</sub> /1.40Ω	—	60V <sub>DC</sub> /1.10Ω	6V <sub>DC</sub> /0.90Ω
0.750	—	30V <sub>DC</sub> /1.00Ω	—	—	6V <sub>DC</sub> /0.36Ω
	—	60V <sub>DC</sub> /1.00Ω	—	—	—
	—	—	—	—	—
1.000	—	30V <sub>DC</sub> /0.48Ω	—	—	—
	—	33V <sub>DC</sub> /0.41Ω	—	—	—
1.100	—	—	—	—	—
	—	—	—	—	—
	—	—	—	—	—
1.200	—	16V <sub>DC</sub> /0.34Ω	—	—	—
1.250	33V <sub>DC</sub> /0.25Ω	15V <sub>DC</sub> /0.25Ω	—	—	—
	—	—	—	—	—
1.500	—	33V <sub>DC</sub> /0.23Ω	15V <sub>DC</sub> /0.25Ω	—	—
	—	—	33V <sub>DC</sub> /0.23Ω	—	—
	—	—	—	—	—
	—	—	—	—	—
1.600	—	—	16V <sub>DC</sub> /0.15Ω	—	—
1.750	—	—	—	—	—
1.850	33V <sub>DC</sub> /0.15Ω	—	33V <sub>DC</sub> /0.165Ω	—	—
2.000	—	24V <sub>DC</sub> /0.125Ω	15V <sub>DC</sub> /0.125Ω	—	—
	—	—	—	—	—
2.500	—	15V <sub>DC</sub> /0.085Ω	15V <sub>DC</sub> /0.85Ω	—	—
2.600	—	6V <sub>DC</sub> /0.075Ω	—	—	—
	—	—	—	—	—
	—	—	—	—	—
	—	—	—	—	—
3.000	24V <sub>DC</sub> /0.072Ω	6V <sub>DC</sub> /0.048Ω	—	—	—
	—	15V <sub>DC</sub> /0.05Ω	—	—	—
3.100	18V <sub>DC</sub> /0.036Ω	—	—	—	—

# PolySwitch Resettable Devices

## Surface-Mount Devices

Table S2 – Thermal Derating [Hold Current (A) at Ambient Temperature (°C)]

Part Number	Maximum Ambient Temperature											
	-40°C	-20°C	0°C	20°C	25°C	40°C	50°C	60°C	70°C	80°C	85°C	125°C
<b>femtoSMDC Series</b> Size 1608mm/0603mils												
femtoSMDC005F	0.08	0.07	0.06	0.05	0.05	0.04	0.04	0.03	0.03	0.02	0.02	—
femtoSMDC008F	0.13	0.11	0.10	0.08	0.08	0.07	0.06	0.06	0.05	0.04	0.04	—
femtoSMDC010F	0.16	0.14	0.12	0.11	0.10	0.09	0.08	0.07	0.06	0.05	0.04	—
femtoSMDC012F	0.18	0.16	0.14	0.12	0.12	0.11	0.10	0.08	0.08	0.07	0.06	—
femtoSMDC016F	0.25	0.22	0.18	0.17	0.16	0.14	0.12	0.11	0.10	0.08	0.07	—
femtoSMDC020F	0.30	0.27	0.24	0.20	0.20	0.17	0.16	0.14	0.12	0.11	0.10	—
femtoSMDC035F	0.53	0.47	0.41	0.36	0.35	0.30	0.27	0.25	0.22	0.19	0.17	—
<b>picoSMDC Series</b> Size 2012mm/0805mils												
picoSMDC010S	0.17	0.15	0.13	0.11	0.10	0.09	0.08	0.07	0.06	0.05	0.05	—
picoSMDC012S	0.20	0.17	0.15	0.13	0.12	0.10	0.09	0.08	0.07	0.06	0.05	—
picoSMDC020S	0.30	0.27	0.24	0.21	0.20	0.18	0.16	0.15	0.13	0.12	0.11	—
picoSMDC035S	0.55	0.49	0.44	0.37	0.35	0.31	0.28	0.26	0.23	0.20	0.18	—
picoSMDC050S	0.70	0.62	0.55	0.55	0.50	0.43	0.38	0.33	0.30	0.28	0.26	—
picoSMDC075S	1.13	1.01	0.90	0.78	0.75	0.67	0.61	0.55	0.49	0.43	0.40	—
picoSMDC110S	1.64	1.47	1.30	1.14	1.10	0.97	0.89	0.80	0.72	0.64	0.59	—
<b>nanoSMDC Series</b> Size 3216mm/1206mils												
<b>NEW</b> nanoSMDC010F	0.15	0.14	0.12	0.10	0.10	0.09	0.08	0.07	0.06	0.05	0.05	—
nanoSMDC012F	0.20	0.17	0.15	0.13	0.12	0.11	0.10	0.09	0.08	0.07	0.07	—
nanoSMDC016F	0.21	0.20	0.18	0.16	0.16	0.14	0.13	0.12	0.11	0.10	0.09	—
nanoSMDC020F	0.34	0.30	0.26	0.22	0.20	0.17	0.15	0.13	0.11	0.09	0.08	—
nanoSMDC025F	0.38	0.33	0.30	0.26	0.25	0.22	0.20	0.19	0.16	0.13	0.11	—
nanoSMDC035F	0.58	0.51	0.44	0.38	0.35	0.31	0.28	0.24	0.21	0.18	0.16	—
nanoSMDC050F/13.2	0.78	0.69	0.61	0.52	0.50	0.44	0.39	0.35	0.30	0.25	0.24	—
nanoSMDC075F	1.15	1.04	0.92	0.78	0.75	0.69	0.63	0.58	0.51	0.46	0.43	—
nanoSMDC110F	1.64	1.46	1.30	1.10	1.06	0.92	0.83	0.80	0.65	0.56	0.52	—
nanoSMDC150F	2.20	1.99	1.77	1.55	1.50	1.34	1.23	1.10	1.01	0.90	0.84	—
nanoSMDC200F	2.92	2.64	2.35	2.07	2.00	1.79	1.64	1.50	1.36	1.22	1.15	—
<b>microSMD Series</b> Size 3225mm/1210mils												
microSMD005F	0.08	0.07	0.06	0.05	0.05	0.04	0.04	0.03	0.03	0.02	0.02	—
microSMD010F	0.15	0.13	0.12	0.10	0.10	0.09	0.08	0.06	0.06	0.05	0.05	—
microSMD035F	0.51	0.46	0.40	0.35	0.34	0.30	0.27	0.24	0.22	0.19	0.18	—
microSMD050F	0.76	0.66	0.58	0.50	0.48	0.42	0.38	0.35	0.29	0.25	0.23	—
microSMD075F	1.10	0.97	0.86	0.75	0.72	0.64	0.58	0.55	0.47	0.42	0.39	—
microSMD110F	1.60	1.42	1.26	1.10	1.06	0.94	0.86	0.80	0.70	0.62	0.58	—
microSMD150F	2.30	2.02	1.76	1.50	1.43	1.24	1.11	1.00	0.85	0.72	0.65	—
microSMD175F	2.80	2.45	2.10	1.75	1.70	1.55	1.45	1.35	1.25	1.15	1.10	—
microSMD200F	2.60	2.44	2.35	2.00	1.96	1.78	1.67	1.50	1.45	1.15	1.10	—
<b>miniSMDC Series</b> Size 4532mm/1812mils												
miniSMDC010F	0.17	0.15	0.13	0.11	0.10	0.09	0.08	0.07	0.06	0.05	0.04	—
miniSMDC014F	0.23	0.20	0.17	0.14	0.13	0.11	0.10	0.09	0.07	0.06	0.05	—
miniSMDC020F	0.30	0.27	0.23	0.20	0.19	0.17	0.15	0.13	0.12	0.10	0.09	—
miniSMDC030F	0.49	0.44	0.39	0.32	0.30	0.27	0.24	0.22	0.18	0.16	0.14	—
miniSMDC050F	0.59	0.57	0.55	0.50	0.48	0.45	0.43	0.35	0.30	0.25	0.23	—
miniSMDC075F	1.10	0.99	0.87	0.75	0.72	0.63	0.57	0.49	0.45	0.39	0.35	—
miniSMDC075F/24	1.50	1.25	1.00	0.75	0.73	0.65	0.60	0.55	0.50	0.45	0.43	—

# PolySwitch Resettable Devices

## Surface-Mount Devices

Table S2 – Thermal Derating [Hold Current (A) at Ambient Temperature (°C)] (Cont'd)

Part Number	Maximum Ambient Temperature											
	-40°C	-20°C	0°C	20°C	25°C	40°C	50°C	60°C	70°C	80°C	85°C	125°C
<b>miniSMDC Series</b>												
<b>Size 4532mm/1812mils</b>												
miniSMDC075F/33	1.09	0.98	0.87	0.77	0.75	0.66	0.61	0.55	0.50	0.45	0.42	—
miniSMDC100F	1.60	1.45	1.28	1.10	1.07	0.92	0.83	0.71	0.66	0.57	0.52	—
miniSMDC110F	1.60	1.45	1.28	1.10	1.07	0.92	0.83	0.71	0.66	0.57	0.52	—
miniSMDC110F/16	1.68	1.49	1.30	1.10	1.05	0.92	0.83	0.75	0.64	0.55	0.50	—
miniSMDC110F/24	2.00	1.70	1.40	1.10	1.06	0.95	0.88	0.80	0.73	0.65	0.61	—
miniSMDC125F	2.00	1.69	1.47	1.25	1.17	1.03	0.92	0.90	0.69	0.58	0.53	—
miniSMDC125F/16	2.00	1.69	1.47	1.25	1.17	1.03	0.92	0.90	0.69	0.58	0.53	—
miniSMDC150F	2.30	2.05	1.77	1.50	1.44	1.23	1.09	0.95	0.82	0.68	0.61	—
miniSMDC150F/12	2.40	2.10	1.80	1.50	1.44	1.25	1.13	1.00	0.88	0.75	0.69	—
miniSMDC150F/16	2.40	2.10	1.80	1.50	1.44	1.25	1.13	1.00	0.88	0.75	0.69	—
miniSMDC150F/24	2.10	1.90	1.70	1.50	1.44	1.25	1.13	1.00	0.88	0.75	0.69	—
miniSMDC160F	2.50	2.19	1.89	1.60	1.53	1.31	1.16	1.10	0.95	0.79	0.71	—
miniSMDC200F	2.60	2.44	2.22	2.00	1.96	1.78	1.67	1.50	1.45	1.34	1.29	—
miniSMDC200F/16	3.07	2.74	2.40	2.07	2.00	1.74	1.57	1.40	1.24	1.07	0.99	—
miniSMDC260F	3.40	3.16	2.80	2.60	2.54	2.32	2.18	2.00	1.90	1.76	1.69	—
miniSMDC260F/12	3.40	3.16	3.00	2.60	2.54	2.32	2.18	2.00	1.90	1.76	1.69	—
miniSMDC260F/13.2	3.40	3.16	3.00	2.60	2.54	2.32	2.18	2.00	1.90	1.76	1.69	—
miniSMDC260F/16	3.50	3.20	3.00	2.60	2.53	2.30	2.15	2.00	1.85	1.70	1.63	—
miniSMDC300F	4.13	3.75	3.33	3.02	3.00	2.70	2.54	2.35	2.22	2.06	1.98	—
<b>midSMD Series</b>												
<b>Size 5050mm/2018mils</b>												
SMD030F-2018	0.48	0.42	0.35	0.30	0.28	0.24	0.21	0.17	0.15	0.12	0.10	—
decaSMDC050F/60	1.00	0.85	0.70	0.55	0.53	0.45	0.40	0.35	0.30	0.25	0.23	—
SMD100F-2018	1.59	1.43	1.20	1.10	1.03	0.94	0.85	0.72	0.69	0.61	0.57	—
SMD150F-2018	2.21	1.97	1.70	1.50	1.43	1.26	1.15	1.00	0.91	0.79	0.73	—
SMD200F-2018	2.81	2.54	2.27	2.00	1.93	1.73	1.59	1.46	1.32	1.19	1.12	—
<b>SMDC Series</b>												
<b>Size 7555mm/2920mils</b>												
<b>NEW</b> SMDC125F/33	2.02	1.78	1.55	1.31	1.25	1.08	0.96	0.84	0.72	0.60	0.54	—
<b>NEW</b> SMDC185F/33	2.83	2.50	2.20	1.85	1.74	1.53	1.37	1.22	1.04	0.88	0.80	—
<b>NEW</b> SMDC300F/24	4.70	4.19	3.70	3.17	3.00	2.66	2.41	2.20	1.90	1.65	1.50	—
<b>NEW</b> SMDC310F/18	4.50	4.06	3.78	3.19	3.10	2.75	2.54	2.32	2.10	1.88	1.76	—
<b>SMD Series</b>												
<b>Size 7555mm/2920mils</b>												
SMD030F	0.44	0.39	0.32	0.30	0.28	0.26	0.23	0.19	0.18	0.17	0.15	—
SMD050F	0.73	0.65	0.55	0.50	0.47	0.43	0.39	0.33	0.31	0.28	0.26	—
SMD075F	1.11	0.99	0.84	0.75	0.71	0.63	0.57	0.49	0.45	0.39	0.36	—
SMD075F/60	1.11	0.99	0.84	0.75	0.71	0.63	0.57	0.49	0.45	0.39	0.36	—
SMD100F	1.59	1.43	1.20	1.10	1.03	0.94	0.85	0.72	0.69	0.61	0.57	—
SMD100F/33	1.48	1.35	1.20	1.10	1.06	0.98	0.91	0.83	0.79	0.73	0.69	—
SMDH120	2.34	1.96	1.58	1.20	1.15	1.02	0.92	0.83	0.74	0.65	0.60	0.26
SMD125F	1.89	1.68	1.50	1.25	1.21	1.04	0.93	0.85	0.71	0.61	0.55	—
SMD150F/33-2920	2.27	2.01	1.76	1.50	1.44	1.25	1.12	0.99	0.86	0.74	0.67	—
SMD200F/24-2920	2.90	2.60	2.30	2.00	1.93	1.70	1.55	1.40	1.25	1.10	1.03	—
SMD250F/15-2920	3.65	3.25	2.80	2.50	2.33	2.02	1.82	1.60	1.41	1.20	1.11	—
SMD260F	3.82	3.41	2.90	2.60	2.45	2.19	1.99	1.70	1.58	1.38	1.28	—
SMD300F	4.13	3.75	3.30	3.00	2.87	2.62	2.43	2.25	2.00	1.87	1.78	—
SMD300F/15	4.20	3.80	3.30	3.00	2.90	2.62	2.43	2.25	2.00	1.87	1.78	—

# PolySwitch Resettable Devices

## Surface-Mount Devices

Table S2 – Thermal Derating [Hold Current (A) at Ambient Temperature (°C)] (Cont'd)

Part Number	Maximum Ambient Temperature												
	-40°C	-20°C	0°C	20°C	25°C	40°C	50°C	60°C	70°C	80°C	85°C	125°C	
<b>SMD2 Series</b>													
<b>Size 8763mm/3425mils</b>													
SMD150F	2.30	2.04	1.80	1.50	1.45	1.23	1.10	0.99	0.83	0.70	0.63	—	
SMD150F/33	2.30	2.04	1.80	1.50	1.45	1.23	1.10	0.99	0.83	0.70	0.63	—	
SMDH160	2.14	1.96	1.78	1.60	1.56	1.42	1.33	1.24	1.15	1.06	1.02	0.44	
SMD185F	2.54	2.29	2.20	1.85	1.80	1.55	1.43	1.31	1.19	1.06	1.00	—	
SMD200F	3.01	2.67	2.30	2.00	1.90	1.66	1.50	1.30	1.16	0.99	0.91	—	
SMD250F	3.72	3.31	2.80	2.50	2.35	2.09	1.89	1.60	1.48	1.28	1.18	—	
<b>High Temperature SMD Series</b>													
<b>Size 3216mm/1206mils &amp; 3225mm/1210mils</b>													
<b>NEW</b>	nanoSMDCH010F	0.18	0.16	0.15	0.11	0.10	0.09	0.08	0.07	0.07	0.06	0.06	0.03
<b>NEW</b>	nanoSMDH075F	1.07	0.98	0.90	0.78	0.75	0.70	0.66	0.61	0.56	0.52	0.50	0.30
<b>NEW</b>	microSMDCH010F	0.18	0.16	0.15	0.11	0.10	0.09	0.08	0.07	0.06	0.05	0.05	0.02
<b>NEW</b>	microSMDCH050F	0.85	0.78	0.75	0.54	0.50	0.48	0.45	0.42	0.38	0.35	0.35	0.18

Figure S1 – Thermal Derating Curve

- A = femtoSMD / picoSMD / nanoSMD / microSMD / miniSMD decaSMD / SMDC and SMD**
- B = SMDH120 / SMDH160 and High Temperature SMD**

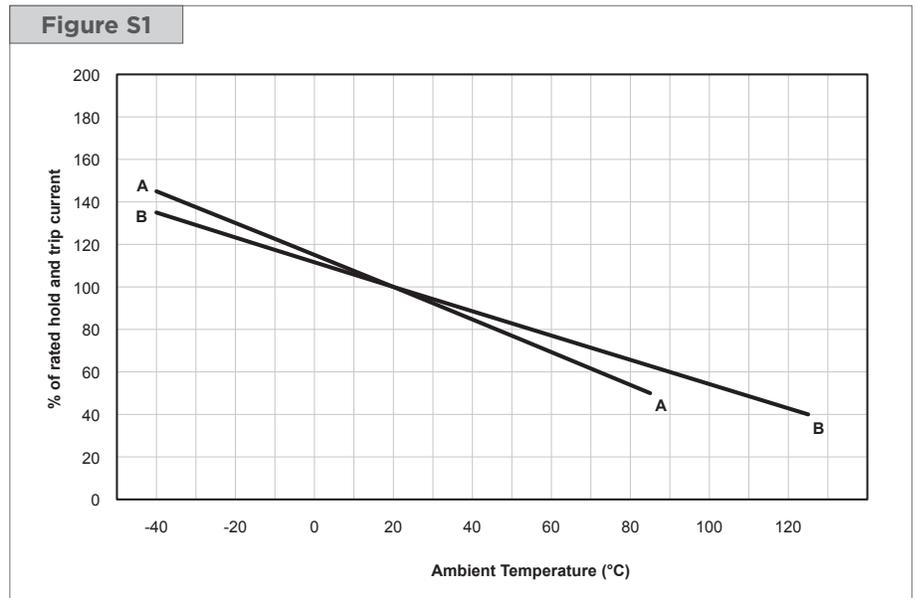

# PolySwitch Resettable Devices

## Surface-Mount Devices

### Table S3 – Electrical Characteristics for Surface-Mount Devices at Room Temperature

Part Number	I <sub>H</sub> (A)	I <sub>T</sub> (A)	V <sub>MAX</sub> (V <sub>DC</sub> )	I <sub>MAX</sub> (A)	P <sub>D MAX</sub> (W)	Max Time-to-Trip		R <sub>MIN</sub> (Ω)	R <sub>TMAX</sub> (Ω)	Figure for Dimensions
						(A)	(S)			
<b>femtoSMDC Series</b> Size 1608mm/0603mils										
femtoSMDC005F	0.05	0.15	15	40	0.50	0.50	0.10	3.80	30.00	S2
femtoSMDC008F	0.08	0.20	12	40	0.50	0.60	0.10	2.80	14.00	S2
femtoSMDC010F	0.10	0.25	12	40	0.50	0.70	0.10	1.70	8.00	S2
femtoSMDC012F	0.12	0.30	9	40	0.50	0.80	0.10	1.10	5.80	S2
femtoSMDC016F	0.16	0.40	9	40	0.50	1.00	0.10	1.00	4.20	S2
femtoSMDC020F	0.20	0.45	9	40	0.50	2.00	0.10	0.70	3.00	S2
femtoSMDC035F	0.35	0.70	6	40	0.50	3.50	0.10	0.28	1.00	S2
<b>picoSMDC Series</b> Size 2012mm/0805mils										
picoSMDC010S	0.10	0.30	15	100	0.50	0.50	0.60	1.50	11.00	S2
picoSMDC012S	0.12	0.30	15	100	0.50	1.00	0.10	1.50	9.00	S2
picoSMDC020S	0.20	0.47	9	100	0.50	2.00	0.10	0.75	3.20	S2
picoSMDC035S	0.35	0.75	6	100	0.50	1.75	0.20	0.35	1.40	S2
picoSMDC050S	0.50	1.00	6	100	0.50	8.00	0.10	0.15	0.80	S2
picoSMDC075S	0.75	1.50	6	40	0.70	8.00	0.20	0.10	0.35	S2
picoSMDC110S	1.10	2.20	6	40	0.80	8.00	0.20	0.05	0.17	S2
<b>nanoSMDC Series</b> Size 3216mm/1206mils										
<b>NEW</b> nanoSMDC010F	0.10	0.25	60	10	0.80	0.50	1.00	1.60	15.00	S2
nanoSMDC012F	0.12	0.39	48	10	0.50	1.00	0.20	1.40	6.50	S2
nanoSMDC016F	0.16	0.45	48	10	0.50	1.00	0.30	1.10	5.00	S2
nanoSMDC020F	0.20	0.42	24	100	0.60	8.00	0.10	0.65	3.10	S2
nanoSMDC025F	0.25	0.58	16	100	0.60	8.00	0.10	0.40	2.10	S2
nanoSMDC035F	0.35	0.75	16	20	0.60	3.50	0.10	0.45	1.35	S2
nanoSMDC050F/13.2	0.50	1.10	13.2	100	0.80	8.00	0.10	0.20	0.75	S2
nanoSMDC075F	0.75	1.50	6	100	0.80	8.00	0.10	0.09	0.30	S2
nanoSMDC110F	1.10	2.20	6	100	0.80	8.00	0.10	0.07	0.20	S2
nanoSMDC150F	1.50	3.00	6	100	0.80	8.00	0.30	0.04	0.11	S2
nanoSMDC200F	2.00	4.00	6	100	1.00	8.00	1.50	0.02	0.072	S2
<b>microSMD Series</b> Size 3225mm/1210mils										
microSMD005F	0.05	0.15	30	10	1.00	0.25	1.50	3.60	50.00	S2
microSMD010F	0.10	0.25	30	10	0.80	0.50	1.00	2.10	15.00	S2
microSMD035F	0.35	0.75	6	40	0.80	8.00	0.20	0.32	1.30	S2
microSMD050F	0.50	1.00	13.2	40	0.80	8.00	0.05	0.25	0.90	S2
microSMD075F	0.75	1.50	6	40	0.80	8.00	0.10	0.11	0.40	S2
microSMD110F	1.10	2.20	6	40	0.80	8.00	0.20	0.07	0.21	S2
microSMD150F	1.50	3.00	6	40	0.80	8.00	1.00	0.04	0.11	S2
microSMD175F	1.75	3.50	6	40	0.80	8.00	0.80	0.025	0.08	S2
microSMD200F	2.00	4.00	6	100	0.80	8.00	2.50	0.020	0.06	S2
<b>miniSMDC Series</b> Size 4532mm/1812mils										
miniSMDC010F	0.10	0.30	60	40	0.75	0.50	5.00	0.70	12.70	S2
miniSMDC014F	0.14	0.28	60	10	0.75	8.00	0.008	1.50	6.00	S2
miniSMDC020F	0.20	0.40	30	10	0.80	8.00	0.02	0.60	3.30	S2
miniSMDC030F	0.30	0.60	30	40	0.80	8.00	0.10	0.20	1.75	S2
miniSMDC050F	0.50	1.00	24	100	0.80	8.00	0.15	0.15	1.00	S2
miniSMDC075F	0.75	1.50	13.2	100	1.00	8.00	0.20	0.11	0.45	S2
miniSMDC075F/24	0.75	1.50	24	40	0.80	8.00	0.30	0.09	0.29	S2

# PolySwitch Resettable Devices

## Surface-Mount Devices

Table S3 – Electrical Characteristics for Surface-Mount Devices  
at Room Temperature

(Cont'd)

Part Number	I <sub>H</sub> (A)	I <sub>T</sub> (A)	V <sub>MAX</sub> (V <sub>DC</sub> )	I <sub>MAX</sub> (A)	P <sub>D MAX</sub> (W)	Max Time-to-Trip		R <sub>MIN</sub> (Ω)	R <sub>TMAX</sub> (Ω)	Figure for Dimensions
						(A)	(S)			
<b>miniSMDC Series</b> Size 4532mm/1812mils										
miniSMDC075F/33	0.75	1.60	33	100	1.00	8.00	1.00	0.11	0.39	S2
miniSMDC100F	1.10	2.20	8	100	1.20	8.00	0.30	0.04	0.21	S2
miniSMDC110F	1.10	2.20	8	100	1.20	8.00	0.30	0.04	0.21	S2
miniSMDC110F/16	1.10	2.20	16	100	0.80	8.00	0.30	0.06	0.18	S2
miniSMDC110F/24	1.10	2.20	24	20	0.80	8.00	0.50	0.06	0.18	S2
miniSMDC125F	1.25	2.50	6	100	0.80	8.00	0.40	0.05	0.14	S2
miniSMDC125F/16	1.25	2.50	16	100	0.80	8.00	0.40	0.05	0.14	S2
miniSMDC150F	1.50	3.00	6	100	0.80	8.00	0.50	0.04	0.11	S2
miniSMDC150F/12	1.50	2.80	12	100	0.80	8.00	0.50	0.04	0.11	S2
miniSMDC150F/16	1.50	2.80	16	100	0.80	8.00	0.50	0.04	0.11	S2
miniSMDC150F/24	1.50	3.00	24	20	1.00	8.00	1.50	0.04	0.12	S2
miniSMDC160F	1.60	3.20	9	100	0.80	8.00	1.00	0.03	0.10	S2
miniSMDC200F	2.00	4.00	8	100	1.00	8.00	5.00	0.020	0.070	S2
miniSMDC200F/16	2.00	4.00	16	40	1.20	8.00	5.00	0.020	0.085	S2
miniSMDC260F	2.60	5.00	6	100	1.00	8.00	5.00	0.015	0.043	S2
miniSMDC260F/12	2.60	5.00	12	100	1.00	8.00	5.00	0.015	0.047	S2
miniSMDC260F/13.2	2.60	5.00	13.2	100	1.20	8.00	5.00	0.015	0.050	S2
miniSMDC260F/16	2.60	5.00	16	100	1.20	8.00	5.00	0.015	0.050	S2
miniSMDC300F	3.00	6.00	6	100	1.00	8.00	5.00	0.011	0.036	S2
<b>midSMD Series</b> Size 5050mm/2018mils										
SMD030F-2018	0.30	0.80	60	20	1.50	1.50	1.50	0.500	2.30	S3
decaSMDC050F/60	0.55	1.10	60	10	1.00	8.00	0.10	0.200	1.10	S2
SMD100F-2018	1.10	2.20	15	40	1.40	8.00	0.50	0.100	0.40	S3
SMD150F-2018	1.50	3.00	15	40	1.80	8.00	1.00	0.070	0.18	S3
SMD200F-2018	2.00	4.20	6	40	1.50	8.00	3.00	0.048	0.10	S3
<b>SMDC Series</b> Size 7555mm/2920mils										
<b>NEW</b> SMDC125F/33	1.25	2.50	33	40	1.50	8.00	2.00	0.040	0.250	S2
<b>NEW</b> SMDC185F/33	1.85	3.70	33	40	1.70	8.00	2.50	0.050	0.150	S2
<b>NEW</b> SMDC300F/24	3.00	6.00	24	40	1.70	8.00	5.00	0.015	0.072	S2
<b>NEW</b> SMDC310F/18	3.10	6.00	18	50	1.50	8.00	25.00	0.013	0.036	S2
<b>SMD Series</b> Size 7555mm/2920mils										
SMD030F	0.30	0.60	60	10	1.70	1.50	3.00	1.200	4.800	S4
SMD050F	0.50	1.00	60	10	1.70	2.50	4.00	0.350	1.400	S4
SMD075F	0.75	1.50	30	40	1.70	8.00	0.30	0.350	1.000	S4
SMD075F/60	0.75	1.50	60	10	1.70	8.00	0.30	0.350	1.000	S4
SMD100F	1.10	2.20	30	40	1.70	8.00	0.50	0.120	0.480	S4
SMD100F/33	1.10	2.20	33	40	1.70	8.00	0.50	0.120	0.410	S4
SMDH120	1.20	2.30	16	50	2.00	8.00	2.00	0.150	0.340	S4
SMD125F	1.25	2.50	15	40	1.70	8.00	2.00	0.070	0.250	S4
SMD150F/33-2920	1.50	3.00	33	40	1.50	8.00	5.00	0.080	0.230	S4
SMD200F/24-2920	2.00	4.00	24	40	1.50	8.00	5.00	0.050	0.125	S4
SMD250F/15-2920	2.50	5.00	15	40	1.50	8.00	10.00	0.035	0.085	S4
SMD260F	2.60	5.20	6	40	1.70	8.00	20.00	0.025	0.075	S4
SMD300F	3.00	6.00	6	40	1.50	8.00	35.00	0.015	0.048	S4
SMD300F/15	3.00	6.00	15	40	1.50	8.00	35.00	0.015	0.050	S4

# PolySwitch Resettable Devices

## Surface-Mount Devices

### Table S3 – Electrical Characteristics for Surface-Mount Devices at Room Temperature

(Cont'd)

Part Number	$I_H$ (A)	$I_T$ (A)	$V_{MAX}$ (V <sub>DC</sub> )	$I_{MAX}$ (A)	$P_{D MAX}$ (W)	Max Time-to-Trip		$R_{MIN}$ (Ω)	$R_{1MAX}$ (Ω)	Figure for Dimensions
						(A)	(S)			
<b>SMD2 Devices</b> Size 8763mm/3425mils										
SMD150F	1.50	3.00	15	40	1.90	8.00	5.00	0.060	0.250	S4
SMD150F/33	1.50	3.00	33	40	1.90	8.00	5.00	0.080	0.230	S4
SMDH160	1.60	3.20	16	70	2.20	8.00	15.00	0.050	0.150	S4
SMD185F	1.85	3.60	33	40	1.50	8.00	5.00	0.065	0.165	S4
SMD200F	2.00	4.00	15	40	1.90	8.00	12.00	0.050	0.125	S4
SMD250F	2.50	5.00	15	40	1.90	8.00	25.00	0.035	0.085	S4
<b>High Temperature SMD Series</b> Size 3216mm/1206mils & 3225mm/1210mils										
<b>NEW</b> nanoSMDCH010F	0.10	0.35	30	10	0.80	1.00	0.10	1.10	10.00	S2
<b>NEW</b> nanoSMDH075F	0.75	2.00	6	10	1.10	8.00	0.10	0.10	0.36	S5
<b>NEW</b> microSMDCH010F	0.10	0.35	30	10	0.90	1.00	0.10	1.20	11.00	S2
<b>NEW</b> microSMDCH050F	0.50	1.50	6	10	1.10	8.00	0.05	0.19	0.90	S2

### Figures S2-S5 – Dimension Figures

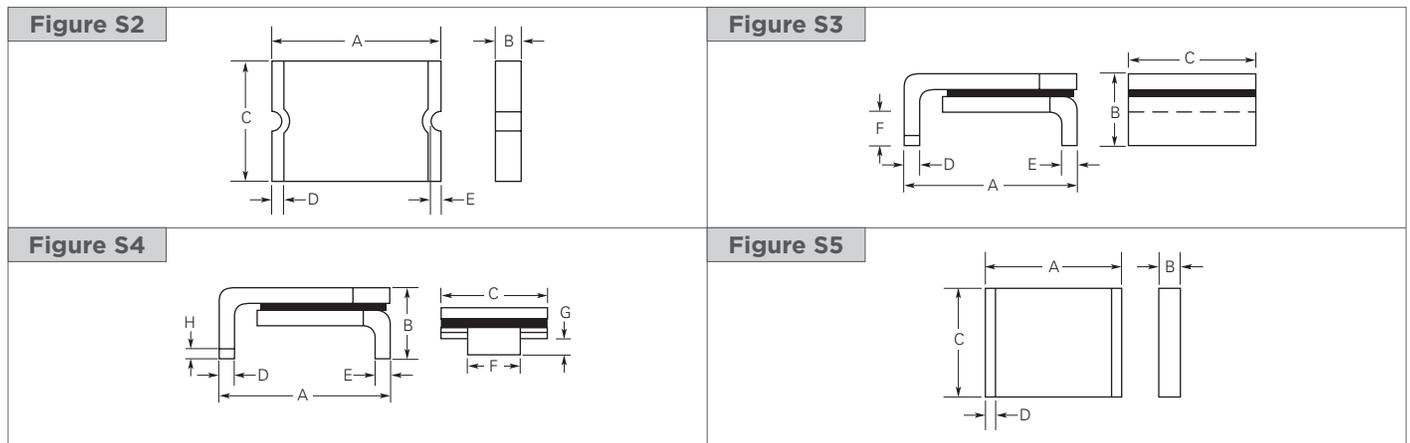

### Table S4 – Dimensions in Millimeters (Inches)

Part Number	A		B		C		D		E		F		G		H	Figure
	Min	Max	Min	Max	Min	Max	Min	Max	Min	Max	Min	Max	Min	Max	Min	
<b>femtoSMDC Series</b> Size 1608mm/0603mils																
femtoSMDC005F	1.40 (0.055)	1.80 (0.071)	0.45 (0.017)	0.85 (0.033)	0.60 (0.023)	1.00 (0.039)	0.10 (0.004)	0.50 (0.020)	0.075 (0.003)	—	—	—	—	—	—	S2
femtoSMDC008F	1.40 (0.055)	1.80 (0.071)	0.45 (0.017)	0.85 (0.033)	0.60 (0.023)	1.00 (0.039)	0.10 (0.004)	0.50 (0.020)	0.075 (0.003)	—	—	—	—	—	—	S2
femtoSMDC010F	1.40 (0.055)	1.80 (0.071)	0.45 (0.017)	0.85 (0.033)	0.60 (0.023)	1.00 (0.039)	0.10 (0.004)	0.50 (0.020)	0.075 (0.003)	—	—	—	—	—	—	S2
femtoSMDC012F	1.40 (0.055)	1.80 (0.071)	0.35 (0.013)	0.75 (0.030)	0.60 (0.023)	1.00 (0.039)	0.10 (0.004)	0.50 (0.020)	0.075 (0.003)	—	—	—	—	—	—	S2

# PolySwitch Resettable Devices

## Surface-Mount Devices

Table S4 – Dimensions in Millimeters (Inches)

(Cont'd)

Part Number	A		B		C		D		E		F		G		H	Figure
	Min	Max	Min	Max	Min	Max	Min	Max	Min	Max	Min	Max	Min	Max	Min	
<b>femtoSMDC Series</b>																
<b>Size 1608mm/0603mils</b>																
femtoSMDC016F	1.40 (0.055)	1.80 (0.071)	0.35 (0.013)	0.75 (0.030)	0.60 (0.023)	1.00 (0.039)	0.10 (0.004)	0.50 (0.020)	0.075 (0.003)	—	—	—	—	—	—	S2
femtoSMDC020F	1.40 (0.055)	1.80 (0.071)	0.35 (0.013)	0.75 (0.030)	0.60 (0.023)	1.00 (0.039)	0.10 (0.004)	0.50 (0.020)	0.075 (0.003)	—	—	—	—	—	—	S2
femtoSMDC035F	1.40 (0.055)	1.80 (0.071)	0.55 (0.021)	0.95 (0.037)	0.60 (0.023)	1.00 (0.039)	0.10 (0.004)	0.50 (0.020)	0.075 (0.003)	—	—	—	—	—	—	S2
<b>picoSMDC Series</b>																
<b>Size 2012mm/0805mils</b>																
picoSMDC010S	2.00 (0.079)	2.20 (0.087)	0.60 (0.023)	1.00 (0.040)	1.30 (0.051)	1.50 (0.059)	0.25 (0.010)	0.75 (0.030)	0.076 (0.003)	—	—	—	—	—	—	S2
picoSMDC012S	2.00 (0.079)	2.20 (0.087)	0.44 (0.017)	0.68 (0.027)	1.30 (0.051)	1.50 (0.059)	0.25 (0.010)	0.75 (0.030)	0.076 (0.003)	—	—	—	—	—	—	S2
picoSMDC020S	2.00 (0.079)	2.20 (0.087)	0.44 (0.017)	0.68 (0.027)	1.30 (0.051)	1.50 (0.059)	0.25 (0.010)	0.75 (0.030)	0.076 (0.003)	—	—	—	—	—	—	S2
picoSMDC035S	2.00 (0.079)	2.20 (0.087)	0.44 (0.017)	0.68 (0.027)	1.30 (0.051)	1.50 (0.059)	0.25 (0.010)	0.75 (0.030)	0.076 (0.003)	—	—	—	—	—	—	S2
picoSMDC050S	2.00 (0.079)	2.20 (0.087)	0.63 (0.025)	0.93 (0.036)	1.30 (0.051)	1.50 (0.059)	0.25 (0.010)	0.75 (0.030)	0.076 (0.003)	—	—	—	—	—	—	S2
picoSMDC075S	2.00 (0.079)	2.20 (0.087)	0.63 (0.025)	0.93 (0.036)	1.30 (0.051)	1.50 (0.059)	0.25 (0.010)	0.75 (0.030)	0.076 (0.003)	—	—	—	—	—	—	S2
picoSMDC110S	2.00 (0.079)	2.20 (0.087)	0.80 (0.031)	1.20 (0.047)	1.30 (0.051)	1.50 (0.059)	0.25 (0.010)	0.75 (0.030)	0.076 (0.003)	—	—	—	—	—	—	S2
<b>nanoSMDC Series</b>																
<b>Size 3216mm/1206mils</b>																
<b>NEW</b> nanoSMDC010F	3.00 (0.118)	3.40 (0.134)	0.62 (0.024)	1.00 (0.039)	1.37 (0.054)	1.80 (0.071)	0.25 (0.010)	0.75 (0.030)	0.076 (0.003)	—	—	—	—	—	—	S2
nanoSMDC012F	3.00 (0.118)	3.40 (0.134)	0.62 (0.024)	1.00 (0.039)	1.37 (0.054)	1.80 (0.071)	0.25 (0.010)	0.75 (0.030)	0.076 (0.003)	—	—	—	—	—	—	S2
nanoSMDC016F	3.00 (0.118)	3.40 (0.134)	0.62 (0.024)	1.00 (0.039)	1.37 (0.054)	1.80 (0.071)	0.25 (0.010)	0.75 (0.030)	0.076 (0.003)	—	—	—	—	—	—	S2
nanoSMDC020F	3.00 (0.118)	3.40 (0.134)	0.58 (0.023)	0.82 (0.032)	1.37 (0.054)	1.80 (0.071)	0.25 (0.010)	0.75 (0.030)	0.076 (0.003)	—	—	—	—	—	—	S2
nanoSMDC025F	3.00 (0.118)	3.40 (0.134)	0.58 (0.023)	0.82 (0.032)	1.37 (0.054)	1.80 (0.071)	0.25 (0.010)	0.75 (0.030)	0.076 (0.003)	—	—	—	—	—	—	S2
nanoSMDC035F	3.00 (0.118)	3.40 (0.134)	0.58 (0.023)	0.82 (0.032)	1.37 (0.054)	1.80 (0.071)	0.25 (0.010)	0.75 (0.030)	0.076 (0.003)	—	—	—	—	—	—	S2
nanoSMDC050F/13.2	3.00 (0.118)	3.40 (0.134)	0.50 (0.019)	0.74 (0.029)	1.37 (0.054)	1.80 (0.071)	0.25 (0.010)	0.75 (0.030)	0.076 (0.003)	—	—	—	—	—	—	S2
nanoSMDC075F	3.00 (0.118)	3.40 (0.134)	0.44 (0.017)	0.68 (0.027)	1.37 (0.054)	1.80 (0.071)	0.25 (0.010)	0.75 (0.030)	0.076 (0.003)	—	—	—	—	—	—	S2
nanoSMDC110F	3.00 (0.118)	3.40 (0.134)	0.28 (0.011)	0.67 (0.026)	1.37 (0.054)	1.80 (0.071)	0.25 (0.010)	0.75 (0.030)	0.076 (0.003)	—	—	—	—	—	—	S2
nanoSMDC150F	3.00 (0.118)	3.40 (0.134)	0.55 (0.022)	0.89 (0.035)	1.37 (0.054)	1.80 (0.071)	0.25 (0.010)	0.75 (0.030)	0.076 (0.003)	—	—	—	—	—	—	S2
nanoSMDC200F	3.00 (0.118)	3.40 (0.134)	0.83 (0.033)	1.10 (0.043)	1.37 (0.054)	1.80 (0.071)	0.25 (0.010)	0.75 (0.030)	0.076 (0.003)	—	—	—	—	—	—	S2

# PolySwitch Resettable Devices

## Surface-Mount Devices

### Table S4 – Dimensions in Millimeters (Inches)

(Cont'd)

Part Number	A		B		C		D		E		F		G		H	Figure
	Min	Max	Min	Max	Min	Max	Min	Max	Min	Max	Min	Max	Min	Max	Min	
<b>microSMD Series</b>																
<b>Size 3225mm/1210mils</b>																
microSMD005F	3.0 (0.118)	3.43 (0.135)	0.50 (0.019)	0.85 (0.034)	2.35 (0.092)	2.80 (0.110)	0.25 (0.010)	0.75 (0.030)	0.076 (0.003)	—	—	—	—	—	—	S2
microSMD010F	3.0 (0.118)	3.43 (0.135)	0.50 (0.019)	0.85 (0.034)	2.35 (0.092)	2.80 (0.110)	0.25 (0.010)	0.75 (0.030)	0.076 (0.003)	—	—	—	—	—	—	S2
microSMD035F	3.0 (0.118)	3.43 (0.135)	0.38 (0.015)	0.62 (0.025)	2.35 (0.092)	2.80 (0.110)	0.25 (0.010)	0.75 (0.030)	0.076 (0.003)	—	—	—	—	—	—	S2
microSMD050F	3.0 (0.118)	3.43 (0.135)	0.38 (0.015)	0.62 (0.025)	2.35 (0.092)	2.80 (0.110)	0.25 (0.010)	0.75 (0.030)	0.076 (0.003)	—	—	—	—	—	—	S2
microSMD075F	3.0 (0.118)	3.43 (0.135)	0.38 (0.015)	0.62 (0.025)	2.35 (0.092)	2.80 (0.110)	0.25 (0.010)	0.75 (0.030)	0.076 (0.003)	—	—	—	—	—	—	S2
microSMD110F	3.0 (0.118)	3.43 (0.135)	0.28 (0.011)	0.48 (0.019)	2.35 (0.092)	2.80 (0.110)	0.25 (0.010)	0.75 (0.030)	0.076 (0.003)	—	—	—	—	—	—	S2
microSMD150F	3.0 (0.118)	3.43 (0.135)	0.51 (0.020)	1.22 (0.048)	2.35 (0.092)	2.80 (0.110)	0.25 (0.010)	0.75 (0.030)	0.076 (0.003)	—	—	—	—	—	—	S2
microSMD175F	3.0 (0.118)	3.43 (0.135)	0.40 (0.016)	0.76 (0.030)	2.35 (0.092)	2.80 (0.110)	0.25 (0.010)	0.75 (0.030)	0.076 (0.003)	—	—	—	—	—	—	S2
microSMD200F	3.0 (0.118)	3.43 (0.135)	0.79 (0.031)	1.17 (0.046)	2.35 (0.092)	2.80 (0.110)	0.25 (0.010)	0.75 (0.030)	0.076 (0.003)	—	—	—	—	—	—	S2
<b>miniSMDC Series</b>																
<b>Size 4532mm/1812mils</b>																
miniSMDC010F	4.37 (0.172)	4.73 (0.186)	0.635 (0.025)	0.89 (0.035)	3.07 (0.121)	3.41 (0.134)	0.25 (0.010)	0.95 (0.040)	0.20 (0.008)	—	—	—	—	—	—	S2
miniSMDC014F	4.37 (0.172)	4.73 (0.186)	0.635 (0.025)	0.89 (0.035)	3.07 (0.121)	3.41 (0.134)	0.25 (0.010)	0.95 (0.040)	0.20 (0.008)	—	—	—	—	—	—	S2
miniSMDC020F	4.37 (0.172)	4.73 (0.186)	0.635 (0.025)	0.89 (0.035)	3.07 (0.121)	3.41 (0.134)	0.25 (0.010)	0.95 (0.040)	0.20 (0.008)	—	—	—	—	—	—	S2
miniSMDC030F	4.37 (0.172)	4.73 (0.186)	0.635 (0.025)	0.89 (0.035)	3.07 (0.121)	3.41 (0.134)	0.25 (0.010)	0.95 (0.040)	0.20 (0.008)	—	—	—	—	—	—	S2
miniSMDC050F	4.37 (0.172)	4.73 (0.186)	0.38 (0.015)	0.62 (0.025)	3.07 (0.121)	3.41 (0.134)	0.25 (0.010)	0.95 (0.040)	0.20 (0.008)	—	—	—	—	—	—	S2
miniSMDC075F	4.37 (0.172)	4.73 (0.186)	0.38 (0.015)	0.62 (0.025)	3.07 (0.121)	3.41 (0.134)	0.25 (0.010)	0.95 (0.040)	0.20 (0.008)	—	—	—	—	—	—	S2
miniSMDC075F/24	4.37 (0.172)	4.83 (0.190)	0.81 (0.032)	1.46 (0.057)	3.07 (0.121)	3.41 (0.134)	0.25 (0.010)	0.95 (0.040)	0.20 (0.008)	—	—	—	—	—	—	S2
miniSMDC075F/33	4.37 (0.172)	4.83 (0.190)	0.94 (0.037)	1.46 (0.057)	3.07 (0.121)	3.41 (0.134)	0.25 (0.010)	0.95 (0.040)	0.20 (0.008)	—	—	—	—	—	—	S2
miniSMDC100F	4.37 (0.172)	4.73 (0.186)	0.38 (0.015)	0.62 (0.025)	3.07 (0.121)	3.41 (0.134)	0.25 (0.010)	0.95 (0.040)	0.20 (0.008)	—	—	—	—	—	—	S2
miniSMDC110F	4.37 (0.172)	4.73 (0.186)	0.38 (0.015)	0.62 (0.025)	3.07 (0.121)	3.41 (0.134)	0.25 (0.010)	0.95 (0.040)	0.20 (0.008)	—	—	—	—	—	—	S2
miniSMDC110F/16	4.37 (0.172)	4.83 (0.190)	0.28 (0.011)	0.48 (0.019)	3.07 (0.121)	3.41 (0.134)	0.25 (0.010)	0.95 (0.040)	0.20 (0.008)	—	—	—	—	—	—	S2
miniSMDC110F/24	4.37 (0.172)	4.83 (0.190)	0.81 (0.032)	1.46 (0.057)	3.07 (0.121)	3.41 (0.134)	0.25 (0.010)	0.95 (0.040)	0.20 (0.008)	—	—	—	—	—	—	S2
miniSMDC125F	4.37 (0.172)	4.73 (0.186)	0.28 (0.011)	0.48 (0.019)	3.07 (0.121)	3.41 (0.134)	0.25 (0.010)	0.95 (0.040)	0.20 (0.008)	—	—	—	—	—	—	S2
miniSMDC125F/16	4.37 (0.172)	4.83 (0.190)	0.28 (0.011)	0.48 (0.019)	3.07 (0.121)	3.41 (0.134)	0.25 (0.010)	0.95 (0.040)	0.20 (0.008)	—	—	—	—	—	—	S2

# PolySwitch Resettable Devices

## Surface-Mount Devices

### Table S4 – Dimensions in Millimeters (Inches)

(Cont'd)

Part Number	A		B		C		D		E		F		G		H	Figure
	Min	Max	Min	Max	Min	Max	Min	Max	Min	Max	Min	Max	Min	Max	Min	
<b>miniSMDC Series</b>																
<b>Size 4532mm/1812mils</b>																
miniSMDC150F	4.37 (0.172)	4.73 (0.186)	0.28 (0.011)	0.48 (0.019)	3.07 (0.121)	3.41 (0.134)	0.25 (0.010)	0.95 (0.040)	0.20 (0.008)	—	—	—	—	—	—	S2
miniSMDC150F/12	4.37 (0.172)	4.83 (0.190)	0.28 (0.011)	0.48 (0.019)	3.07 (0.121)	3.41 (0.134)	0.25 (0.010)	0.95 (0.040)	0.20 (0.008)	—	—	—	—	—	—	S2
miniSMDC150F/16	4.37 (0.172)	4.83 (0.190)	0.28 (0.011)	0.48 (0.019)	3.07 (0.121)	3.41 (0.134)	0.25 (0.010)	0.95 (0.040)	0.20 (0.008)	—	—	—	—	—	—	S2
miniSMDC150F/24	4.37 (0.172)	4.83 (0.190)	1.00 (0.040)	1.94 (0.077)	3.07 (0.121)	3.41 (0.134)	0.25 (0.010)	0.95 (0.040)	0.20 (0.008)	—	—	—	—	—	—	S2
miniSMDC160F	4.37 (0.172)	4.73 (0.186)	0.28 (0.011)	0.48 (0.019)	3.07 (0.121)	3.41 (0.134)	0.25 (0.010)	0.95 (0.040)	0.20 (0.008)	—	—	—	—	—	—	S2
miniSMDC200F	4.37 (0.172)	4.73 (0.186)	0.51 (0.020)	1.22 (0.048)	3.07 (0.121)	3.41 (0.134)	0.25 (0.010)	0.95 (0.040)	0.20 (0.008)	—	—	—	—	—	—	S2
miniSMDC200F/16	4.37 (0.172)	4.73 (0.186)	0.51 (0.020)	1.22 (0.048)	3.07 (0.121)	3.41 (0.134)	0.25 (0.010)	0.95 (0.040)	0.20 (0.008)	—	—	—	—	—	—	S2
miniSMDC260F	4.37 (0.172)	4.73 (0.186)	0.48 (0.019)	0.78 (0.031)	3.07 (0.121)	3.41 (0.134)	0.25 (0.010)	0.95 (0.040)	0.20 (0.008)	—	—	—	—	—	—	S2
miniSMDC260F/12	4.37 (0.172)	4.83 (0.190)	1.02 (0.042)	1.52 (0.060)	3.07 (0.121)	3.41 (0.134)	0.25 (0.010)	0.95 (0.040)	0.20 (0.008)	—	—	—	—	—	—	S2
miniSMDC260F/13.2	4.37 (0.172)	4.83 (0.190)	1.02 (0.042)	1.52 (0.060)	3.07 (0.121)	3.41 (0.134)	0.25 (0.010)	0.95 (0.040)	0.20 (0.008)	—	—	—	—	—	—	S2
miniSMDC260F/16	4.37 (0.172)	4.83 (0.190)	1.02 (0.042)	1.52 (0.060)	3.07 (0.121)	3.41 (0.134)	0.25 (0.010)	0.95 (0.040)	0.20 (0.008)	—	—	—	—	—	—	S2
miniSMDC300F	4.37 (0.172)	4.73 (0.186)	0.45 (0.018)	0.76 (0.030)	3.07 (0.121)	3.41 (0.134)	0.25 (0.010)	0.95 (0.040)	0.20 (0.008)	—	—	—	—	—	—	S2
<b>midSMD Series</b>																
<b>Size 5050mm/2018mils</b>																
SMD030F-2018	4.72 (0.186)	5.44 (0.214)	—	1.78 (0.070)	4.22 (0.166)	4.93 (0.194)	0.25 (0.010)	0.36 (0.014)	0.25 (0.010)	0.36 (0.014)	0.30 (0.012)	0.46 (0.018)	—	—	—	S3
decaSMDC050F/60	4.70 (0.185)	5.31 (0.209)	0.63 (0.025)	0.89 (0.035)	4.19 (0.165)	4.81 (0.189)	0.25 (0.010)	0.95 (0.040)	0.25 (0.010)	—	—	—	—	—	—	S2
SMD100F-2018	4.72 (0.186)	5.44 (0.214)	—	1.52 (0.060)	4.22 (0.166)	4.93 (0.194)	0.25 (0.010)	0.36 (0.014)	0.25 (0.010)	0.36 (0.014)	0.30 (0.012)	0.46 (0.018)	—	—	—	S3
SMD150F-2018	4.72 (0.186)	5.44 (0.214)	—	1.52 (0.060)	4.22 (0.166)	4.93 (0.194)	0.25 (0.010)	0.36 (0.014)	0.25 (0.010)	0.36 (0.014)	0.30 (0.012)	0.46 (0.018)	—	—	—	S3
SMD200F-2018	4.72 (0.186)	5.44 (0.214)	—	1.52 (0.060)	4.22 (0.166)	4.93 (0.194)	0.25 (0.010)	0.36 (0.014)	0.25 (0.010)	0.36 (0.014)	0.30 (0.012)	0.46 (0.018)	—	—	—	S3
<b>SMDC Series</b>																
<b>Size 7555mm/2920mils</b>																
<b>NEW</b> SMDC125F/33	7.30 (0.287)	7.70 (0.303)	0.45 (0.018)	0.71 (0.028)	4.90 (0.193)	5.30 (0.209)	0.25 (0.010)	0.95 (0.040)	0.20 (0.008)	—	—	—	—	—	—	S2
<b>NEW</b> SMDC185F/33	7.30 (0.287)	7.70 (0.303)	0.90 (0.035)	1.20 (0.047)	4.90 (0.193)	5.30 (0.209)	0.25 (0.010)	0.95 (0.040)	0.20 (0.008)	—	—	—	—	—	—	S2
<b>NEW</b> SMDC300F/24	7.30 (0.287)	7.70 (0.303)	0.80 (0.031)	1.10 (0.043)	4.90 (0.193)	5.30 (0.209)	0.25 (0.010)	0.95 (0.040)	0.20 (0.008)	—	—	—	—	—	—	S2
<b>NEW</b> SMDC310F/18	7.30 (0.287)	7.70 (0.303)	1.10 (0.043)	1.70 (0.067)	4.90 (0.193)	5.30 (0.209)	0.95 (0.037)	1.45 (0.057)	0.35 (0.014)	—	—	—	—	—	—	S2

# PolySwitch Resettable Devices

## Surface-Mount Devices

### Table S4 – Dimensions in Millimeters (Inches)

(Cont'd)

Part Number	A		B		C		D		E		F		G		H	Figure
	Min	Max	Min	Max	Min	Max	Min	Max	Min	Max	Min	Max	Min	Max	Min	
<b>SMD Series</b>																
<b>Size 7555mm/2920mils</b>																
SMD030F	6.73 (0.265)	7.98 (0.314)	—	3.18 (0.125)	4.80 (0.19)	5.44 (0.214)	0.56 (0.022)	0.71 (0.028)	0.56 (0.022)	0.71 (0.028)	2.16 (0.085)	2.41 (0.095)	0.66 (0.026)	1.37 (0.054)	0.43 (0.017)	S4
SMD050F	6.73 (0.265)	7.98 (0.314)	—	3.18 (0.125)	4.80 (0.19)	5.44 (0.214)	0.56 (0.022)	0.71 (0.028)	0.56 (0.022)	0.71 (0.028)	2.16 (0.085)	2.41 (0.095)	0.66 (0.026)	1.37 (0.054)	0.43 (0.017)	S4
SMD075F	6.73 (0.265)	7.98 (0.314)	—	3.18 (0.125)	4.80 (0.19)	5.44 (0.214)	0.56 (0.022)	0.71 (0.028)	0.56 (0.022)	0.71 (0.028)	2.16 (0.085)	2.41 (0.095)	0.66 (0.026)	1.37 (0.054)	0.43 (0.017)	S4
SMD075F/60	6.73 (0.265)	7.98 (0.314)	—	3.18 (0.125)	4.80 (0.19)	5.44 (0.214)	0.56 (0.022)	0.71 (0.028)	0.56 (0.022)	0.71 (0.028)	2.16 (0.085)	2.41 (0.095)	0.66 (0.026)	1.37 (0.054)	0.43 (0.017)	S4
SMD100F	6.73 (0.265)	7.98 (0.314)	—	3.00 (0.118)	4.80 (0.19)	5.44 (0.214)	0.56 (0.022)	0.71 (0.028)	0.56 (0.022)	0.71 (0.028)	2.16 (0.085)	2.41 (0.095)	0.66 (0.026)	1.37 (0.054)	0.43 (0.017)	S4
SMD100F/33	6.73 (0.265)	7.98 (0.314)	—	3.00 (0.118)	4.80 (0.19)	5.44 (0.214)	0.56 (0.022)	0.71 (0.028)	0.56 (0.022)	0.71 (0.028)	2.16 (0.085)	2.41 (0.095)	0.66 (0.026)	1.37 (0.054)	0.43 (0.017)	S4
SMDH120	6.73 (0.265)	7.98 (0.314)	—	3.00 (0.118)	4.80 (0.19)	5.44 (0.214)	0.56 (0.022)	0.71 (0.028)	0.56 (0.022)	0.71 (0.028)	2.16 (0.085)	2.41 (0.095)	0.66 (0.026)	1.37 (0.054)	0.43 (0.017)	S4
SMD125F	6.73 (0.265)	7.98 (0.314)	—	3.00 (0.118)	4.80 (0.19)	5.44 (0.214)	0.56 (0.022)	0.71 (0.028)	0.56 (0.022)	0.71 (0.028)	2.16 (0.085)	2.41 (0.095)	0.66 (0.026)	1.37 (0.054)	0.43 (0.017)	S4
SMD150F/33-2920	6.73 (0.265)	7.98 (0.314)	—	3.00 (0.118)	4.80 (0.19)	5.44 (0.214)	0.56 (0.022)	0.71 (0.028)	0.56 (0.022)	0.71 (0.028)	2.16 (0.085)	2.41 (0.095)	0.66 (0.026)	1.37 (0.054)	0.43 (0.017)	S4
SMD200F/24-2920	6.73 (0.265)	7.98 (0.314)	—	3.00 (0.118)	4.80 (0.19)	5.44 (0.214)	0.56 (0.022)	0.71 (0.028)	0.56 (0.022)	0.71 (0.028)	2.16 (0.085)	2.41 (0.095)	0.66 (0.026)	1.37 (0.054)	0.43 (0.017)	S4
SMD250F/15-2920	6.73 (0.265)	7.98 (0.314)	—	3.00 (0.118)	4.80 (0.19)	5.44 (0.214)	0.56 (0.022)	0.71 (0.028)	0.56 (0.022)	0.71 (0.028)	2.16 (0.085)	2.41 (0.095)	0.66 (0.026)	1.37 (0.054)	0.43 (0.017)	S4
SMD260F	6.73 (0.265)	7.98 (0.314)	—	3.00 (0.118)	4.80 (0.19)	5.44 (0.214)	0.56 (0.022)	0.71 (0.028)	0.56 (0.022)	0.71 (0.028)	2.16 (0.085)	2.41 (0.095)	0.66 (0.026)	1.37 (0.054)	0.43 (0.017)	S4
SMD300F	6.73 (0.265)	7.98 (0.314)	—	3.00 (0.118)	4.80 (0.19)	5.44 (0.214)	0.56 (0.022)	0.71 (0.028)	0.56 (0.022)	0.71 (0.028)	2.16 (0.085)	2.41 (0.095)	0.66 (0.026)	1.37 (0.054)	0.43 (0.017)	S4
SMD300F/15	6.73 (0.265)	7.98 (0.314)	—	3.00 (0.118)	4.80 (0.19)	5.44 (0.214)	0.56 (0.022)	0.71 (0.028)	0.56 (0.022)	0.71 (0.028)	2.16 (0.085)	2.41 (0.095)	0.66 (0.026)	1.37 (0.054)	0.43 (0.017)	S4
<b>SMD2 Devices</b>																
<b>Size 8763mm/3425mils</b>																
SMD150F	8.00 (0.315)	9.40 (0.370)	—	3.00 (0.118)	6.00 (0.236)	6.71 (0.264)	0.56 (0.022)	0.71 (0.028)	0.56 (0.022)	0.71 (0.028)	3.68 (0.145)	3.94 (0.155)	0.66 (0.026)	1.37 (0.054)	0.43 (0.017)	S4
SMD150F/33	8.00 (0.315)	9.40 (0.370)	—	3.00 (0.118)	6.00 (0.236)	6.71 (0.264)	0.56 (0.022)	0.71 (0.028)	0.56 (0.022)	0.71 (0.028)	3.68 (0.145)	3.94 (0.155)	0.66 (0.026)	1.37 (0.054)	0.43 (0.017)	S4
SMDH160	8.00 (0.315)	9.40 (0.370)	—	3.00 (0.118)	6.00 (0.236)	6.71 (0.264)	0.56 (0.022)	0.71 (0.028)	0.56 (0.022)	0.71 (0.028)	3.68 (0.145)	3.94 (0.155)	0.66 (0.026)	1.37 (0.054)	0.43 (0.017)	S4
SMD185F	8.00 (0.315)	9.40 (0.370)	—	3.00 (0.118)	6.00 (0.236)	6.71 (0.264)	0.56 (0.022)	0.71 (0.028)	0.56 (0.022)	0.71 (0.028)	3.68 (0.145)	3.94 (0.155)	0.66 (0.026)	1.37 (0.054)	0.43 (0.017)	S4
SMD200F	8.00 (0.315)	9.40 (0.370)	—	3.00 (0.118)	6.00 (0.236)	6.71 (0.264)	0.56 (0.022)	0.71 (0.028)	0.56 (0.022)	0.71 (0.028)	3.68 (0.145)	3.94 (0.155)	0.66 (0.026)	1.37 (0.054)	0.43 (0.017)	S4
SMD250F	8.00 (0.315)	9.40 (0.370)	—	3.00 (0.118)	6.00 (0.236)	6.71 (0.264)	0.56 (0.022)	0.71 (0.028)	0.56 (0.022)	0.71 (0.028)	3.68 (0.145)	3.94 (0.155)	0.66 (0.026)	1.37 (0.054)	0.43 (0.017)	S4
<b>High Temperature SMD Series</b>																
<b>Size 3216mm/1206mils &amp; 3225mm/1210mils</b>																
<b>NEW</b>	nanoSMDCH010F	3.00 (0.118)	3.40 (0.134)	0.30 (0.012)	0.70 (0.028)	1.37 (0.054)	1.80 (0.071)	0.25 (0.010)	0.75 (0.030)	0.076 (0.003)	—	—	—	—	—	S2
<b>NEW</b>	nanoSMDH075F	3.00 (0.118)	3.40 (0.134)	0.60 (0.023)	1.00 (0.039)	1.40 (0.055)	1.80 (0.071)	0.20 (0.008)	0.80 (0.032)	—	—	—	—	—	—	S5
<b>NEW</b>	microSMDCH010F	3.00 (0.118)	3.43 (0.135)	0.57 (0.022)	0.97 (0.038)	2.35 (0.092)	2.80 (0.110)	0.25 (0.010)	0.75 (0.030)	0.076 (0.003)	—	—	—	—	—	S2
<b>NEW</b>	microSMDCH050F	3.00 (0.118)	3.43 (0.135)	0.24 (0.009)	0.64 (0.025)	2.35 (0.092)	2.80 (0.110)	0.25 (0.010)	0.75 (0.030)	0.076 (0.003)	—	—	—	—	—	S2

# PolySwitch Resettable Devices

## Surface-Mount Devices

### Figures S6-S15 – Typical Time-to-Trip Curves at 20°C

#### femtoSMDCxxxF

- A = femtoSMDC005F
- B = femtoSMDC008F
- C = femtoSMDC010F
- D = femtoSMDC012F
- E = femtoSMDC016F
- F = femtoSMDC020F
- G = femtoSMDC035F

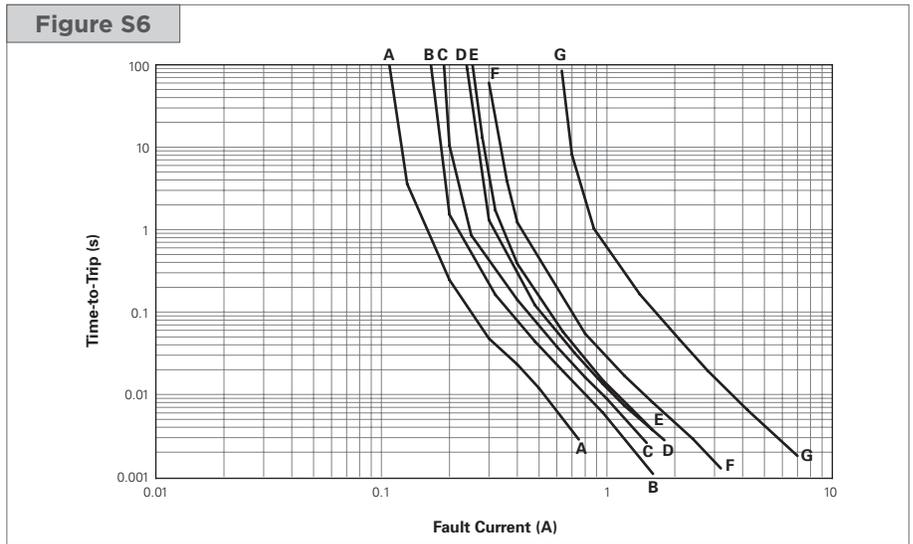

#### picoSMDCxxxS

- A = picoSMDC010S
- B = picoSMDC012S
- C = picoSMDC020S
- D = picoSMDC035S
- E = picoSMDC050S
- F = picoSMDC075S
- G = picoSMDC110S

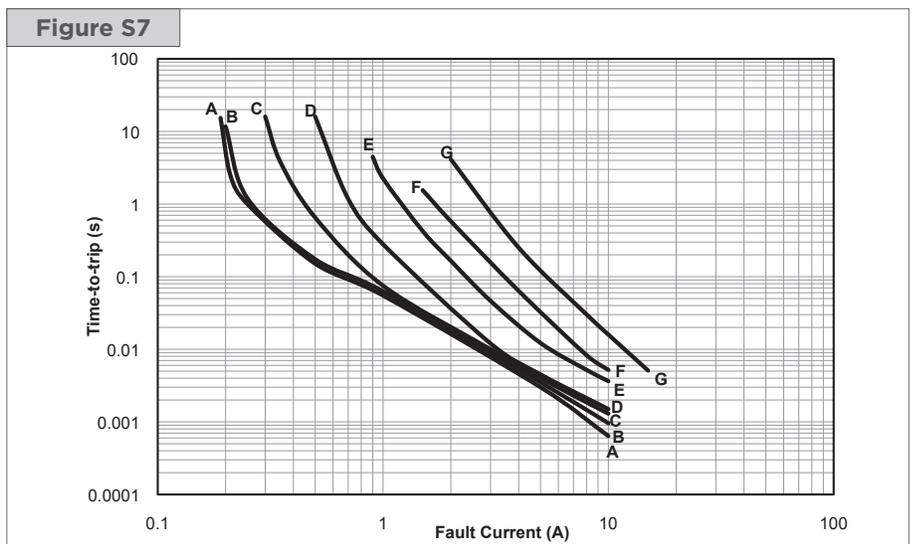

#### nanoSMDCxxxF

- A = nanoSMDC010F
- B = nanoSMDC012F
- C = nanoSMDC016F
- D = nanoSMDC020F
- E = nanoSMDC025F
- F = nanoSMDC035F
- G = nanoSMDC050F/13.2
- H = nanoSMDC075F
- I = nanoSMDC110F
- J = nanoSMDC150F
- K = nanoSMDC200F

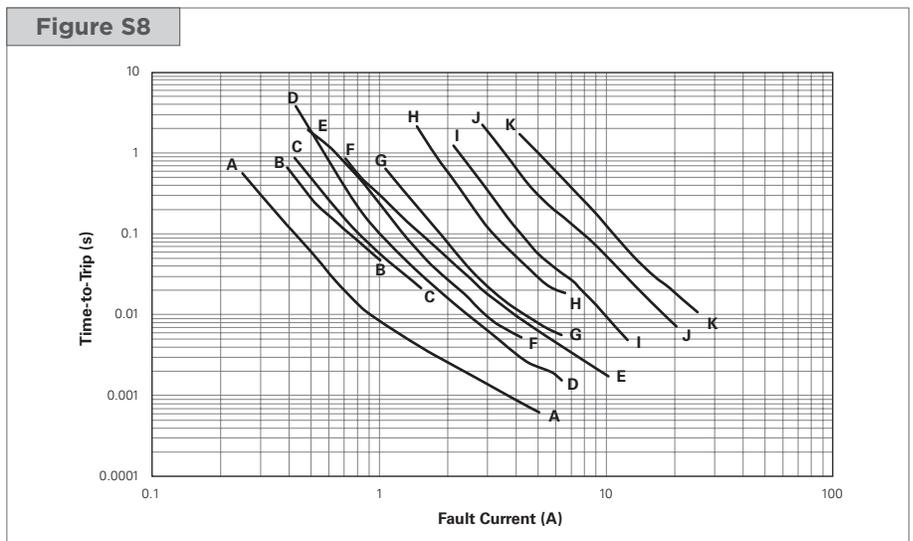

# PolySwitch Resettable Devices

## Surface-Mount Devices

### Figures S6-S15 — Typical Time-to-Trip Curves at 20°C

(Cont'd)

#### microSMDxxxF

- A = microSMD005F
- B = microSMD010F
- C = microSMD035F
- D = microSMD050F
- E = microSMD075F
- F = microSMD110F
- G = microSMD150F
- H = microSMD175F
- I = microSMD200F

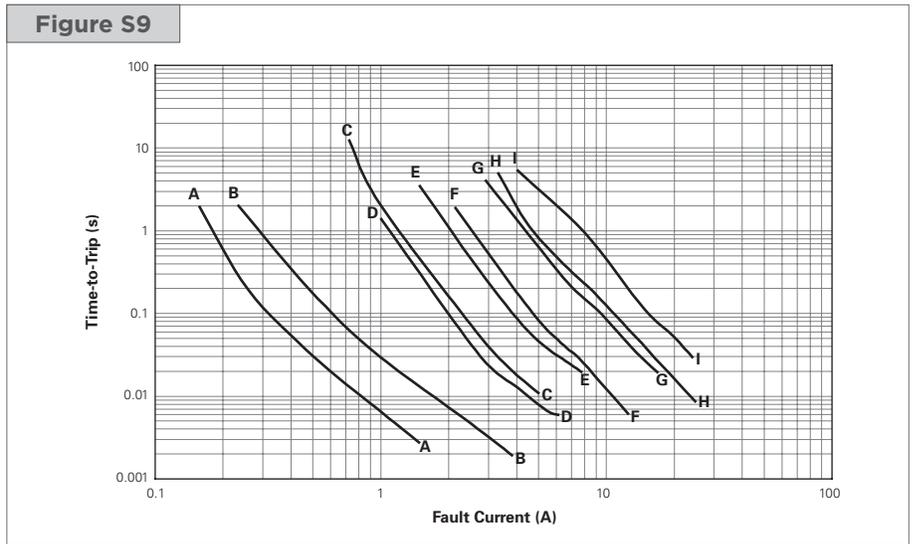

#### miniSMDCxxxF

- A = miniSMDC010F, miniSMDC014F
- B = miniSMDC020F
- C = miniSMDC030F
- D = miniSMDC050F
- E = miniSMDC075F
- F = miniSMDC075F/24

- G = miniSMDC075F/33
- H = miniSMDC100F, miniSMDC110F
- I = miniSMDC110F/16
- J = miniSMDC110F/24
- K = miniSMDC125F
- L = miniSMDC125F/16
- M = miniSMDC150F, miniSMDC150F/12
- N = miniSMDC150F/16

- O = miniSMDC150F/24
- P = miniSMDC160F
- Q = miniSMDC200F
- R = miniSMDC200F/16
- S = miniSMDC260F
- T = miniSMDC260F/12, miniSMDC260F/13.2, miniSMDC260F/16
- U = miniSMDC300F

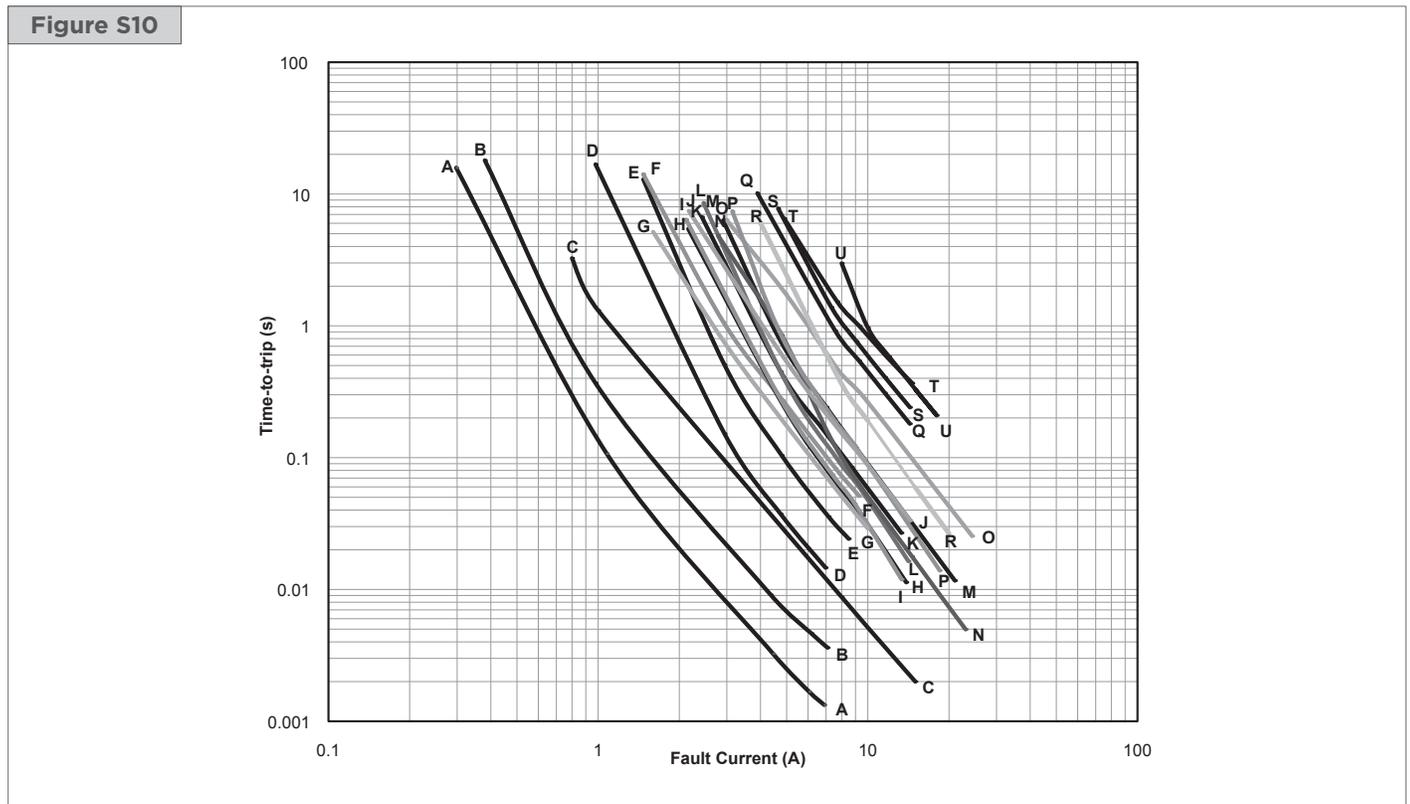

# PolySwitch Resettable Devices

## Surface-Mount Devices

### Figures S6-S15 — Typical Time-to-Trip Curves at 20°C

(Cont'd)

#### midSMD

- A = SMD030F-2018
- B = decaSMDC050F/60
- C = SMD100F-2018
- D = SMD150F-2018
- E = SMD200F-2018

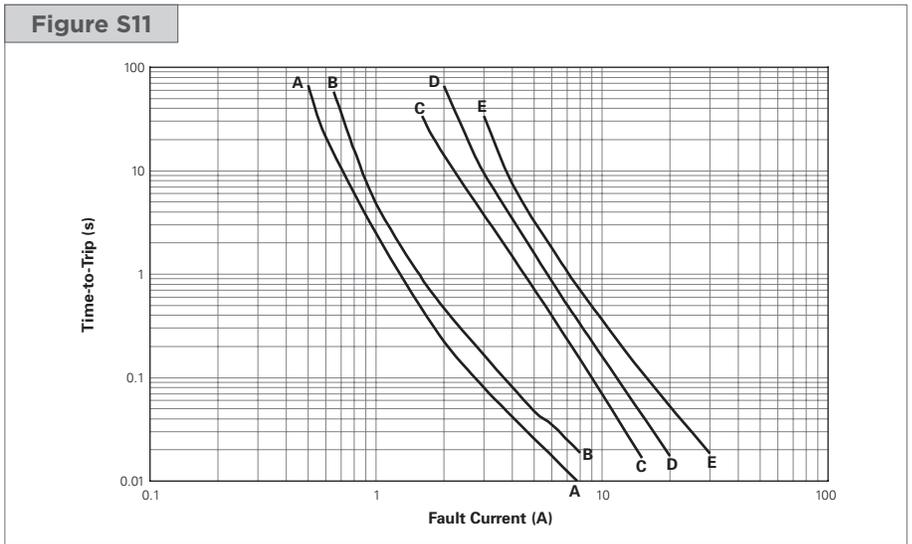

#### SMDCxxxF

- A = SMDC125F/33
- B = SMDC185F/33
- C = SMDC300F/24
- D = SMDC310F/18

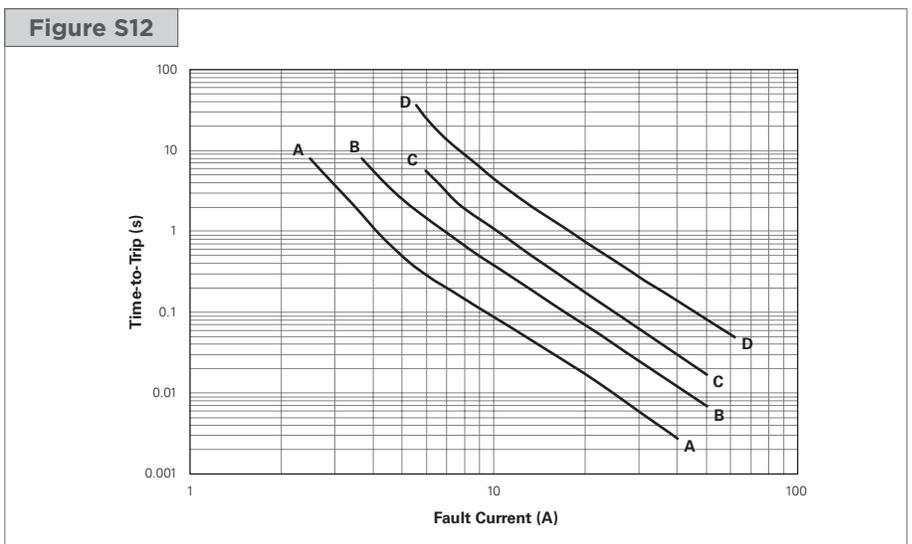

#### SMDxxxF

- A = SMD030F
- B = SMD050F
- C = SMD075F, SMD075F/60
- D = SMD100F, SMD100F/33
- E = SMDH120
- F = SMD150F/33-2920
- G = SMD125F
- H = SMD200F/24-2920
- I = SMD250F/15-2920
- J = SMD260F
- K = SMD300F, SMD300F/15

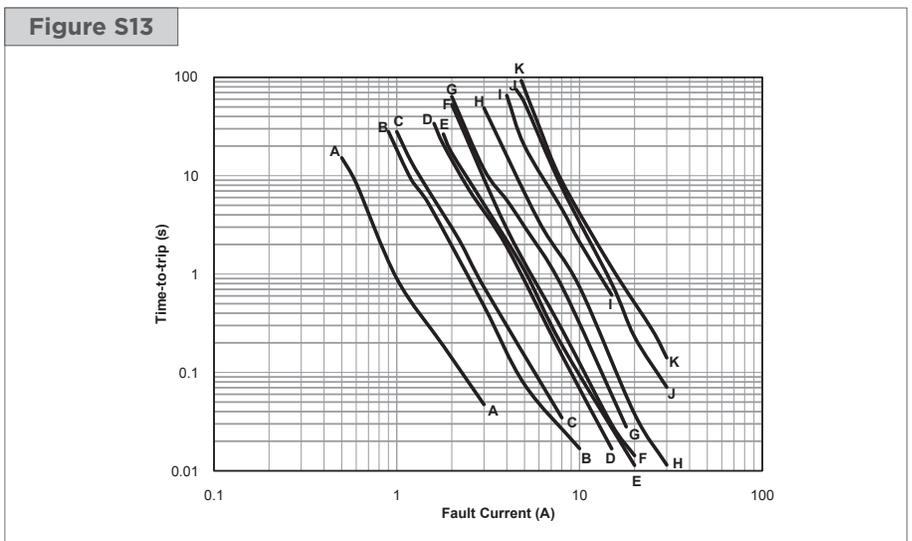

# PolySwitch Resettable Devices

## Surface-Mount Devices

### Figures S6-S15 — Typical Time-to-Trip Curves at 20°C

(Cont'd)

#### SMD2xxxF

- A = SMD150F, SMD150F/33
- B = SMDH160
- C = SMD185F
- D = SMD200F
- E = SMD250F

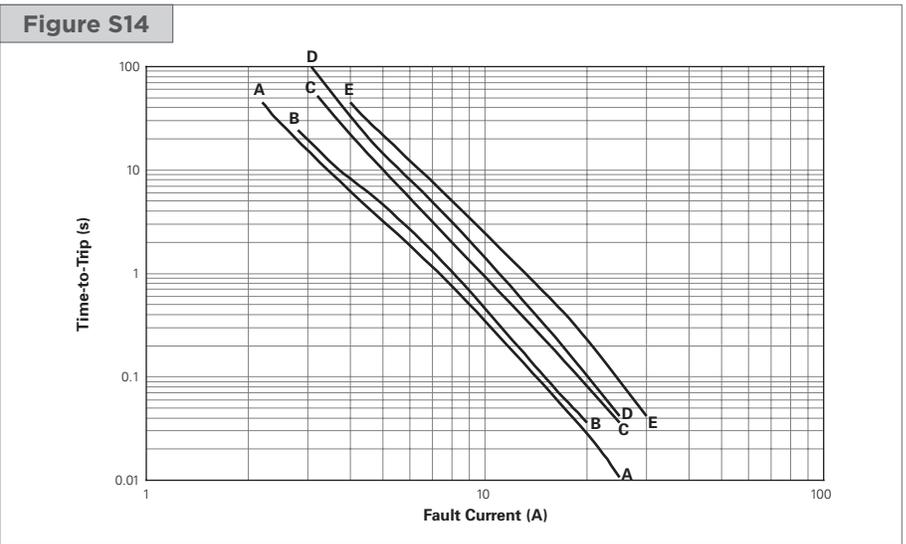

#### High Temperature SMD

- A = nanoSMDCH010F
- B = microSMDCH010F
- C = microSMDCH050F
- D = nanoSMDH075F

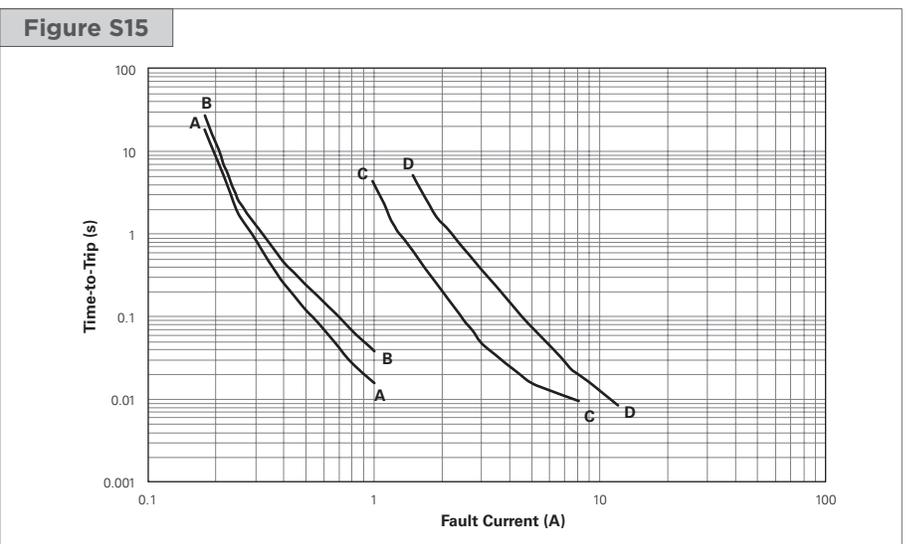

# PolySwitch Resettable Devices

## Surface-Mount Devices

### Table S5 — Physical Characteristics and Environmental Specifications

Operating temperature range -40°C to 85°C, -40°C to 125°C for SMDH120, SMDH160 and High Temperature SMD

Physical Characteristics			
Terminal Pad Material	100% Matte Tin with Nickel Underplate		
Soldering Characteristics	ANSI/J-STD-002 Category 3 for femtoSMD, picoSMD, nanoSMD, microSMD, miniSMD and SMDC Series ANSI/J-STD-002 Category 1 for SMD Series		
Solder Heat Withstand	per IEC-STD 68-2-20, Test Tb, Section 5, Method 1A		
Flammability Resistance	per IEC 695-2-2 Needle Flame Test for 20 seconds		
Recommended Storage Conditions	40°C max, 70% R.H. max; Devices May Not Meet Specified Ratings if Storage Conditions Are Exceeded		
Environmental Specifications			
Test	Test Method	Conditions	Resistance Change
Storage Life	PS300, Section 5.3.2	60°C, 1000 hrs	±3% typ
		85°C, 1000 hrs	±5% typ
Humidity Aging	PS300, Section 5.3.1	85°C, 85% RH, 100 hrs	±1.2% typ
Thermal Shock	MIL-STD-202, Method 107G	85°C, -40°C (20 Times)	-33% typ
		125°C, -55°C (10 Times)	-33% typ
Vibration	MIL-STD-883C	per MIL-STD-883C	No Change
Solvent Resistance	PS300, Section 5.2.2	Freon	No Change
		Trichloroethane	No Change
		Hydrocarbons	No Change

### Table S6 — Packaging and Marking Information

Part Number	Tape and Reel Quantity	Standard Package	Part Marking	Recommended Pad Layout Figures [mm (in)]			Agency Recognition
				Dimension A (Nom)	Dimension B (Nom)	Dimension C (Nom)	
<b>femtoSMDC Series</b> Size 1608mm/0603mils							
femtoSMDC005F	4,000	20,000	A	0.80 (0.032)	0.60 (0.024)	0.80 (0.032)	UL, CSA
femtoSMDC008F	4,000	20,000	T	0.80 (0.032)	0.60 (0.024)	0.80 (0.032)	UL, CSA
femtoSMDC010F	4,000	20,000	B	0.80 (0.032)	0.60 (0.024)	0.80 (0.032)	UL, CSA, TÜV
femtoSMDC012F	5,000	25,000	C	0.80 (0.032)	0.60 (0.024)	0.80 (0.032)	UL, CSA
femtoSMDC016F	5,000	25,000	E	0.80 (0.032)	0.60 (0.024)	0.80 (0.032)	UL, CSA
femtoSMDC020F	5,000	25,000	F	0.80 (0.032)	0.60 (0.024)	0.80 (0.032)	UL, CSA, TÜV
femtoSMDC035F	4,000	20,000	K	0.80 (0.032)	0.60 (0.024)	0.80 (0.032)	UL, CSA
<b>picoSMDC Series</b> Size 2012mm/0805mils							
picoSMDC010S	3,000	15,000	C	1.50 (0.060)	1.00 (0.039)	1.20 (0.047)	UL, CSA, TÜV
picoSMDC012S	4,000	20,000	F	1.50 (0.060)	1.00 (0.039)	1.20 (0.047)	UL, CSA, TÜV
picoSMDC020S	4,000	20,000	H	1.50 (0.060)	1.00 (0.039)	1.20 (0.047)	UL, CSA, TÜV
picoSMDC035S	4,000	20,000	I	1.50 (0.060)	1.00 (0.039)	1.20 (0.047)	UL, CSA, TÜV
picoSMDC050S	3,000	15,000	K	1.50 (0.060)	1.00 (0.039)	1.20 (0.047)	UL, CSA, TÜV
picoSMDC075S	3,000	15,000	M	1.50 (0.060)	1.00 (0.039)	1.20 (0.047)	UL, CSA, TÜV
picoSMDC110S	3,000	15,000	S	1.50 (0.060)	1.00 (0.039)	1.20 (0.047)	UL, TÜV
<b>nanoSMDC Series</b> Size 3216mm/1206mils							
<b>NEW</b> nanoSMDC010F	3,000	15,000	A	1.60 (0.063)	1.00 (0.039)	2.00 (0.079)	UL, TÜV
nanoSMDC012F	3,000	15,000	P	1.60 (0.063)	1.00 (0.039)	2.00 (0.079)	UL, CSA, TÜV
nanoSMDC016F	3,000	15,000	N	1.60 (0.063)	1.00 (0.039)	2.00 (0.079)	UL, CSA, TÜV

# PolySwitch Resettable Devices

## Surface-Mount Devices

### Table S6 — Packaging and Marking Information

(Cont'd)

Part Number	Tape and Reel Quantity	Standard Package	Part Marking	Recommended Pad Layout Figures [mm (in)]			Agency Recognition
				Dimension A (Nom)	Dimension B (Nom)	Dimension C (Nom)	
<b>nanoSMDC Series</b>							
<b>Size 3216mm/1206mils</b>							
nanoSMDC020F	3,000	15,000	02	1.60 (0.063)	1.00 (0.039)	2.00 (0.079)	UL, CSA, TÜV
nanoSMDC025F	3,000	15,000	C	1.60 (0.063)	1.00 (0.039)	2.00 (0.079)	UL, CSA, TÜV
nanoSMDC035F	3,000	15,000	03	1.60 (0.063)	1.00 (0.039)	2.00 (0.079)	UL, CSA, TÜV
nanoSMDC050F/13.2	3,000	15,000	M	1.60 (0.063)	1.00 (0.039)	2.00 (0.079)	UL, CSA, TÜV
nanoSMDC075F	3,000	15,000	L	1.60 (0.063)	1.00 (0.039)	2.00 (0.079)	UL, CSA, TÜV
nanoSMDC110F	3,000	15,000	K	1.60 (0.063)	1.00 (0.039)	2.00 (0.079)	UL, CSA, TÜV
nanoSMDC150F	3,000	15,000	15	1.60 (0.063)	1.00 (0.039)	2.00 (0.079)	UL, CSA, TÜV
nanoSMDC200F	3,000	15,000	T	1.60 (0.063)	1.00 (0.039)	2.00 (0.079)	UL, CSA, TÜV
<b>microSMD Series</b>							
<b>Size 3225mm/1210mils</b>							
microSMD005F	4,000	20,000	05	2.50 (0.098)	1.00 (0.039)	2.00 (0.079)	UL, CSA, TÜV
microSMD010F	4,000	20,000	10	2.50 (0.098)	1.00 (0.039)	2.00 (0.079)	UL, CSA, TÜV
microSMD035F	4,000	20,000	3	2.50 (0.098)	1.00 (0.039)	2.00 (0.079)	UL, CSA, TÜV
microSMD050F	4,000	20,000	50	2.50 (0.098)	1.00 (0.039)	2.00 (0.079)	UL, CSA, TÜV
microSMD075F	4,000	20,000	75	2.50 (0.098)	1.00 (0.039)	2.00 (0.079)	UL, CSA, TÜV
microSMD110F	4,000	20,000	11	2.50 (0.098)	1.00 (0.039)	2.00 (0.079)	UL, CSA, TÜV
microSMD150F	4,000	20,000	15	2.50 (0.098)	1.00 (0.039)	2.00 (0.079)	UL, CSA, TÜV
microSMD175F	4,000	20,000	17	2.50 (0.098)	1.00 (0.039)	2.00 (0.079)	UL, CSA, TÜV
microSMD200F	3,000	15,000	20	2.50 (0.098)	1.00 (0.039)	2.00 (0.079)	UL, CSA, TÜV
<b>miniSMDC Series</b>							
<b>Size 4532mm/1812mils</b>							
miniSMDC010F	2,000	10,000	10	3.15 (0.124)	1.68 (0.066)	3.10 (0.122)	UL, CSA, TÜV
miniSMDC014F	2,000	10,000	14	3.15 (0.124)	1.68 (0.066)	3.10 (0.122)	UL, CSA, TÜV
miniSMDC020F	2,000	10,000	2	3.15 (0.124)	1.68 (0.066)	3.10 (0.122)	UL, CSA, TÜV
miniSMDC030F	2,000	10,000	3	3.15 (0.124)	1.68 (0.066)	3.10 (0.122)	UL, CSA, TÜV
miniSMDC050F	2,000	10,000	5	3.15 (0.124)	1.68 (0.066)	3.10 (0.122)	UL, CSA, TÜV
miniSMDC075F	2,000	10,000	7	3.15 (0.124)	1.68 (0.066)	3.10 (0.122)	UL, CSA, TÜV
miniSMDC075F/24	1,500	7,500	075F 24V	3.15 (0.124)	1.68 (0.066)	3.10 (0.122)	UL, CSA, TÜV
miniSMDC075F/33	1,500	7,500	075F 33V	3.15 (0.124)	1.68 (0.066)	3.10 (0.122)	UL, CSA, TÜV
miniSMDC100F	2,000	10,000	1	3.15 (0.124)	1.68 (0.066)	3.10 (0.122)	UL, CSA, TÜV
miniSMDC110F	2,000	10,000	1	3.15 (0.124)	1.68 (0.066)	3.10 (0.122)	UL, CSA, TÜV
miniSMDC110F/16	2,000	10,000	110F 16V	3.15 (0.124)	1.68 (0.066)	3.10 (0.122)	UL, CSA, TÜV
miniSMDC110F/24	1,500	7,500	110F 24V	3.15 (0.124)	1.68 (0.066)	3.10 (0.122)	UL, CSA, TÜV
miniSMDC125F	2,000	10,000	12	3.15 (0.124)	1.68 (0.066)	3.10 (0.122)	UL, CSA, TÜV
miniSMDC125F/16	2,000	10,000	125F 16V	3.15 (0.124)	1.68 (0.066)	3.10 (0.122)	UL, CSA, TÜV
miniSMDC150F	2,000	10,000	15	3.15 (0.124)	1.68 (0.066)	3.10 (0.122)	UL, CSA, TÜV
miniSMDC150F/12	2,000	10,000	150F 12V	3.15 (0.124)	1.68 (0.066)	3.10 (0.122)	UL, CSA, TÜV
miniSMDC150F/16	2,000	10,000	150 16V	3.15 (0.124)	1.68 (0.066)	3.10 (0.122)	UL, CSA, TÜV
miniSMDC150F/24	1,000	5,000	150F 24V	3.15 (0.124)	1.68 (0.066)	3.10 (0.122)	UL, CSA, TÜV
miniSMDC160F	2,000	10,000	16	3.15 (0.124)	1.68 (0.066)	3.10 (0.122)	UL, CSA, TÜV
miniSMDC200F	2,000	10,000	20	3.15 (0.124)	1.68 (0.066)	3.10 (0.122)	UL, CSA, TÜV
miniSMDC200F/16	2,000	10,000	200F 16V	3.15 (0.124)	1.68 (0.066)	3.10 (0.122)	UL, TÜV
miniSMDC260F	2,000	10,000	260F	3.15 (0.124)	1.68 (0.066)	3.10 (0.122)	UL, CSA, TÜV
miniSMDC260F/12	1,500	7,500	260F 12V	3.15 (0.124)	1.68 (0.066)	3.10 (0.122)	UL, CSA, TÜV
miniSMDC260F/13.2	1,500	7,500	260F 13V	3.15 (0.124)	1.68 (0.066)	3.10 (0.122)	UL, CSA, TÜV
miniSMDC260F/16	1,500	7,500	260F 16V	3.15 (0.124)	1.68 (0.066)	3.10 (0.122)	UL, CSA, TÜV
miniSMDC300F	2,000	10,000	30	3.15 (0.124)	1.68 (0.066)	3.10 (0.122)	UL, CSA, TÜV

# PolySwitch Resettable Devices

## Surface-Mount Devices

Table S6 — Packaging and Marking Information

(Cont'd)

Part Number	Tape and Reel Quantity	Standard Package	Part Marking	Recommended Pad Layout Figures [mm (in)]			Agency Recognition
				Dimension A (Nom)	Dimension B (Nom)	Dimension C (Nom)	
<b>midSMD Series</b>							
<b>Size 5050mm/2018mils</b>							
SMD030F-2018	4,000	20,000	A03F	4.60 (0.18)	1.50 (0.059)	3.40 (0.134)	UL, CSA, TÜV
decaSMDC050F/60	1,000	5,000	050F 60V	4.32 (0.17)	1.40 (0.055)	3.61 (0.142)	UL, CSA, TÜV
SMD100F-2018	4,000	20,000	A10F	4.60 (0.18)	1.50 (0.059)	3.40 (0.134)	UL, CSA, TÜV
SMD150F-2018	4,000	20,000	A15F	4.60 (0.18)	1.50 (0.059)	3.40 (0.134)	UL, CSA, TÜV
SMD200F-2018	4,000	20,000	A20F	4.60 (0.18)	1.50 (0.059)	3.40 (0.134)	UL, CSA, TÜV
<b>SMDC Series</b>							
<b>Size 7555mm/2920mils</b>							
<b>NEW</b> SMDC125F/33	4,000	20,000	125F	5.30 (0.209)	2.00 (0.079)	4.60 (0.18)	UL
<b>NEW</b> SMDC185F/33	4,000	20,000	185F 33V	5.30 (0.209)	2.00 (0.079)	4.60 (0.18)	UL, CSA, TÜV
<b>NEW</b> SMDC300F/24	4,000	20,000	300F 24V	5.30 (0.209)	2.00 (0.079)	4.60 (0.18)	UL, CSA, TÜV
<b>NEW</b> SMDC310F/18	3,000	15,000	310F 18V	5.30 (0.209)	2.00 (0.079)	4.60 (0.18)	UL, CSA, TÜV
<b>SMD Series</b>							
<b>Size 7555mm/2920mils</b>							
SMD030F	2,000	10,000	030F	3.10 (0.12)	2.30 (0.09)	5.10 (0.201)	UL, CSA, TÜV
SMD050F	2,000	10,000	050F	3.10 (0.12)	2.30 (0.09)	5.10 (0.201)	UL, CSA, TÜV
SMD075F	2,000	10,000	075F	3.10 (0.12)	2.30 (0.09)	5.10 (0.201)	UL, CSA, TÜV
SMD075F/60	2,000	10,000	756F	3.10 (0.12)	2.30 (0.09)	5.10 (0.201)	UL, CSA, TÜV
SMD100F	2,000	10,000	100F	3.10 (0.12)	2.30 (0.09)	5.10 (0.201)	UL, CSA, TÜV
SMD100F/33	2,000	10,000	103F	3.10 (0.12)	2.30 (0.09)	5.10 (0.201)	UL, CSA, TÜV
SMDH120	2,000	10,000	H12	3.10 (0.12)	2.30 (0.09)	5.10 (0.201)	UL, CSA, TÜV
SMD125F	2,000	10,000	125F	3.10 (0.12)	2.30 (0.09)	5.10 (0.201)	UL, CSA, TÜV
SMD150F/33-2920	2,000	10,000	S15F	3.10 (0.12)	2.30 (0.09)	5.10 (0.201)	UL, CSA, TÜV
SMD200F/24-2920	2,000	10,000	S20F	3.10 (0.12)	2.30 (0.09)	5.10 (0.201)	UL, CSA, TÜV
SMD250F/15-2920	2,000	10,000	S25F	3.10 (0.12)	2.30 (0.09)	5.10 (0.201)	UL, CSA, TÜV
SMD260F	2,000	10,000	260F	3.10 (0.12)	2.30 (0.09)	5.10 (0.201)	UL, CSA, TÜV
SMD300F	2,000	10,000	300F	3.10 (0.12)	2.30 (0.09)	5.10 (0.201)	UL, CSA, TÜV
SMD300F/15	2,000	10,000	315F	3.10 (0.12)	2.30 (0.09)	5.10 (0.201)	UL, CSA, TÜV
<b>SMD2 Devices</b>							
<b>Size 8763mm/3425mils</b>							
SMD150F	1,500	7,500	150F	4.60 (0.18)	2.30 (0.09)	6.10 (0.240)	UL, CSA, TÜV
SMD150F/33	1,500	7,500	153F	4.60 (0.18)	2.30 (0.09)	6.10 (0.240)	UL, CSA, TÜV
SMDH160	1,500	7,500	160F	4.60 (0.18)	2.30 (0.09)	6.10 (0.240)	UL, CSA, TÜV
SMD185F	1,500	7,500	185F	4.60 (0.18)	2.30 (0.09)	6.10 (0.240)	UL, CSA, TÜV
SMD200F	1,500	7,500	200F	4.60 (0.18)	2.30 (0.09)	6.10 (0.240)	UL, CSA, TÜV
SMD250F	1,500	7,500	250F	4.60 (0.18)	2.30 (0.09)	6.10 (0.240)	UL, CSA, TÜV
<b>High Temperature SMD Series</b>							
<b>Size 3216mm/1206mils &amp; 3225mm/1210mils</b>							
<b>NEW</b> nanoSMDCH010F	4,000	20,000	H01	1.60 (0.063)	1.00 (0.039)	2.00 (0.079)	—
<b>NEW</b> nanoSMDH075F	3,000	15,000	H75	1.60 (0.063)	1.00 (0.039)	2.00 (0.079)	—
<b>NEW</b> microSMDCH010F	3,000	15,000	H01	2.50 (0.098)	1.00 (0.039)	2.00 (0.079)	—
<b>NEW</b> microSMDCH050F	4,000	20,000	H05	2.50 (0.098)	1.00 (0.039)	2.00 (0.079)	—

# PolySwitch Resettable Devices

## Surface-Mount Devices

Figure S16 – Recommended Pad Layout

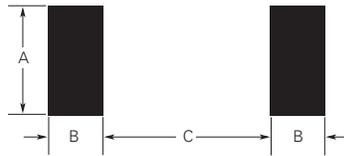

## Agency Recognition

UL	File # E74889 for all Surface-mount Devices
CSA	File # CA78165 for all Surface-mount Devices
TÜV	Certificate Number Available Upon Request (Certified to IEC 60730-1)

## Solder Reflow and Rework Recommendation

### Classification Reflow Profiles

Profile Feature	Pb-Free Assembly
<b>Average Ramp-up Rate (<math>T_{s_{MAX}}</math> to <math>T_p</math>)</b>	3°C/s max
<b>Preheat</b>	
• Temperature min ( $T_{s_{MIN}}$ )	150°C
• Temperature max ( $T_{s_{MAX}}$ )	200°C
• Time ( $t_{s_{MIN}}$ to $t_{s_{MAX}}$ )	60-120s
<b>Time Maintained Above:</b>	
• Temperature ( $T_L$ )	217°C
• Time ( $t_L$ )	60-150s
<b>Peak/Classification Temperature (<math>T_p</math>)</b>	260°C
<b>Time within 5°C of Actual Peak Temperature</b>	
Time ( $t_p$ )	30s max
<b>Ramp-down Rate</b>	3°C/s max
<b>Time 25°C to Peak Temperature</b>	8 mins max

**Note:** All temperatures refer to topside of the package, measured on the package body surface.

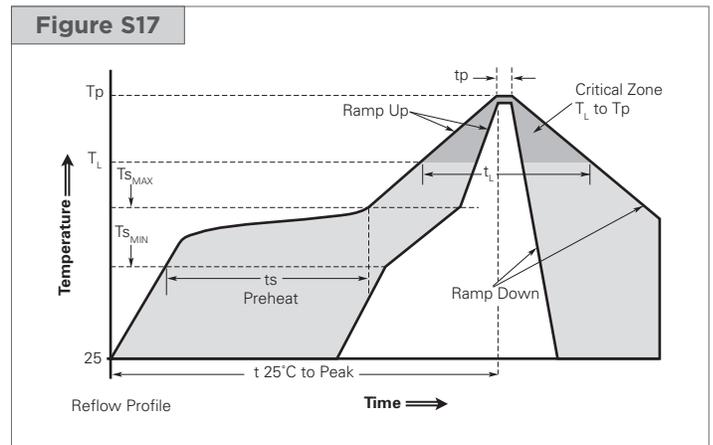

## Solder Reflow

- Recommended reflow methods:
  - IR
  - Hot air
  - Nitrogen
- Recommended maximum paste thickness: 0.25mm (0.010in)
- Devices can be cleaned using standard methods and aqueous solvents.
- Experience has shown the optimum conditions for forming acceptable solder fillets occur when a reasonable amount of solder paste is placed underneath each device's termination. As such, we request that customers comply with our recommended solder pad layouts.
- Customer should validate that the solder paste amount and reflow recommendations meet its application.
- We request that customer board layouts refrain from placing raised features (e.g. vias, nomenclature, traces, etc.) underneath PolySwitch devices. It is possible that raised features could negatively impact solderability performance of our devices.

## Rework

- femtoSMD, picoSMD, nanoSMD, microSMD, miniSMD and SMDC series: standard industry practices. (Please also avoid direct contact to the device.)
- SMD series: Rework should be confined to removal of the installed product and replacement with a fresh device.

# PolySwitch Resettable Devices

## Surface-Mount Devices

### Table S7 – Tape and Reel Specifications (Millimeters)

Description	nanoSMDC nanoSMDC010F and nanoSMDC012F		microSMD microSMDC010F and microSMDC012F		miniSMDC and decaSMDC050F/60		midSMD except decaSMDC050F/60		SMDC	SMD	SMD2
	EIA 481-1	EIA 481-1	EIA 481-1	EIA 481-1	EIA 481-1	EIA 481-1	EIA 481-2	EIA 481-1	EIA 481-1	EIA 481-2	EIA 481-2
W	8.0 ± 0.30	8.0 ± 0.30	8.0 ± 0.30	8.0 ± 0.30	12.0 ± 0.30	16.0 ± 0.30	16.0 ± 0.30	16.0 ± 0.30	16.0 ± 0.30	16.0 ± 0.30	16.0 ± 0.30
P <sub>0</sub>	4.0 ± 0.10	4.0 ± 0.10	4.0 ± 0.10	4.0 ± 0.10	4.0 ± 0.10	4.0 ± 0.10	4.0 ± 0.10	4.0 ± 0.10	4.0 ± 0.10	4.0 ± 0.10	4.0 ± 0.10
P <sub>1</sub>	4.0 ± 0.10	4.0 ± 0.10	4.0 ± 0.10	4.0 ± 0.10	8.0 ± 0.10	8.0 ± 0.10	8.0 ± 0.10	8.0 ± 0.10	8.0 ± 0.10	8.0 ± 0.10	12.0 ± 0.10
P <sub>2</sub>	2.0 ± 0.05	2.0 ± 0.10	2.0 ± 0.05	2.0 ± 0.05	2.0 ± 0.05	2.0 ± 0.05	2.0 ± 0.10	2.0 ± 0.10	2.0 ± 0.10	2.0 ± 0.10	2.0 ± 0.10
A <sub>0</sub>	0.95 ± 0.05	1.70 ± 0.10	1.95 ± 0.10	2.9 ± 0.10	Table S8	Table S8	5.11 ± 0.15	Table S8	Table S8	5.6 ± 0.23	6.9 ± 0.23
B <sub>0</sub>	1.85 ± 0.05	2.45 ± 0.10	Table S8	Table S8	Table S8	Table S8	5.6 ± 0.23	Table S8	Table S8	8.1 ± 0.15	9.6 ± 0.15
B <sub>1</sub> max	4.35	4.35	4.35	4.35	6.15	6.15	6.4	12.1	12.1	12.1	12.1
D <sub>0</sub>	1.55 ± 0.05	1.55 ± 0.05	1.55 ± 0.05	1.55 ± 0.05	1.55 ± 0.05	1.55 ± 0.05	1.5 ± 0.10/-00	1.5 ± 0.10/-00	1.5 ± 0.10/-00	1.5 ± 0.10/-00	1.5 ± 0.10/-00
F	3.50 ± 0.05	3.50 ± 0.05	3.50 ± 0.05	3.50 ± 0.05	5.50 ± 0.10	5.50 ± 0.10	7.50 ± 0.10	7.50 ± 0.10	7.50 ± 0.10	7.50 ± 0.10	7.50 ± 0.10
E <sub>1</sub>	1.75 ± 0.10	1.75 ± 0.10	1.75 ± 0.10	1.75 ± 0.10	1.75 ± 0.10	1.75 ± 0.10	1.75 ± 0.10	1.75 ± 0.10	1.75 ± 0.10	1.75 ± 0.10	1.75 ± 0.10
E <sub>2</sub> min	6.25	6.25	6.25	6.25	6.25	10.25	14.25	14.25	14.25	14.25	14.25
T max	0.3	0.3	0.3	0.3	0.35	0.35	0.4	0.35	0.4	0.4	0.4
T <sub>1</sub> max	0.1	0.1	0.1	0.1	0.1	0.1	0.1	0.1	0.1	0.1	0.1
K <sub>0</sub>	Table S8	Table S8	Table S8	Table S8	Table S8	Table S8	1.8 ± 0.15	Table S8	Table S8	3.2 ± 0.15	3.4 ± 0.15

### Table S8 – Tape and Reel Specifications (Millimeters)

Description	femtoSMDC005F femtoSMDC008F femtoSMDC010F femtoSMDC035F		femtoSMDC012F femtoSMDC016F femtoSMDC020F		picoSMDC012S picoSMDC020S picoSMDC035S		picoSMDC010S picoSMDC050S picoSMDC075S		picoSMDC110S		nanoSMDC010F and All nanoSMDC series except nanoSMDC010F nanoSMDC012F nanoSMDC016F nanoSMDC200F		nanoSMDC010F and All nanoSMDC series except nanoSMDC010F nanoSMDC012F nanoSMDC016F nanoSMDC200F		microSMDC050F and All microSMD series except microSMD200F			
	A <sub>0</sub>	B <sub>0</sub>	K <sub>0</sub>	A <sub>0</sub>	B <sub>0</sub>	K <sub>0</sub>	A <sub>0</sub>	B <sub>0</sub>	K <sub>0</sub>	A <sub>0</sub>	B <sub>0</sub>	K <sub>0</sub>	A <sub>0</sub>	B <sub>0</sub>	K <sub>0</sub>	A <sub>0</sub>	B <sub>0</sub>	K <sub>0</sub>
A <sub>0</sub>	0.95 ± 0.05	0.95 ± 0.05	1.70 ± 0.1	1.70 ± 0.1	1.70 ± 0.1	1.95 ± 0.1	1.95 ± 0.1	2.9 ± 0.1										
B <sub>0</sub>	1.85 ± 0.05	1.85 ± 0.05	2.45 ± 0.1	2.45 ± 0.1	2.45 ± 0.1	3.50 ± 0.1/-0.08	3.5 ± 0.1	3.5 ± 0.1										
K <sub>0</sub>	0.90 ± 0.1	0.55 ± 0.05	0.86 ± 0.1	1.12 ± 0.1	1.35 ± 0.1	0.89 ± 0.1	1.27 ± 0.1	0.9 ± 0.1										
Description	microSMDC010F microSMD200F		miniSMDC010F miniSMDC014F~075F miniSMDC100F~110F/16 miniSMDC125F~150F/16 miniSMDC160F~260F miniSMDC300F		miniSMDC075F/24 miniSMDC075F/33 miniSMDC110F/24 miniSMDC260F/12 miniSMDC260F/13.2 miniSMDC260F/16		miniSMDC150F/24		decaSMDC050F/60		SMDC125F/33		SMDC185F/33 SMDC300F/24		SMDC310F/18			
	A <sub>0</sub>	B <sub>0</sub>	K <sub>0</sub>	A <sub>0</sub>	B <sub>0</sub>	K <sub>0</sub>	A <sub>0</sub>	B <sub>0</sub>	K <sub>0</sub>	A <sub>0</sub>	B <sub>0</sub>	K <sub>0</sub>	A <sub>0</sub>	B <sub>0</sub>	K <sub>0</sub>			
A <sub>0</sub>	2.9 ± 0.1	3.5 ± 0.1	3.7 ± 0.1	3.7 ± 0.1	5.0 ± 0.1	5.5 ± 0.1	5.35 ± 0.1	5.5 ± 0.1										
B <sub>0</sub>	3.55 ± 0.1	4.95 ± 0.1	4.9 ± 0.1	4.9 ± 0.1	5.4 ± 0.1	7.9 ± 0.1	7.85 ± 0.1	8.0 ± 0.1										
K <sub>0</sub>	1.27 ± 0.1	0.9 ± 0.1	1.4 ± 0.1	1.78 ± 0.1	1.7 ± 0.1	0.9 ± 0.1	1.45 ± 0.1	2.0 ± 0.1										

### Table S9 – Reel Dimensions (Millimeters)

Description	femto/pico/nano/microSMD/ High Temperature SMD		miniSMDC		midSMD		SMD/SMDC		SMD2	
	A max	N min	W <sub>1</sub>	W <sub>2</sub> max	A max	N min	W <sub>1</sub>	W <sub>2</sub> max	A max	N min
A max	185	50	12.4 + 2.0/-00	18.4	330	50	16.4 + 2.0/-00	22.4	330	50
N min	50	50	16.4 + 2.0/-00	18.4	50	50	16.4 + 2.0/-00	22.4	330	50
W <sub>1</sub>	8.4 + 1.5/-00	12.4 + 2.0/-00	16.4 + 2.0/-00	18.4	16.4 + 2.0/-00	16.4 + 2.0/-00	16.4 + 2.0/-00	16.4 + 2.0/-00	16.4 + 2.0/-00	16.4 + 2.0/-00
W <sub>2</sub> max	14.4	18.4	22.4	22.4	22.4	22.4	22.4	22.4	22.4	22.4

# PolySwitch Resettable Devices

## Surface-Mount Devices

Figure S18 – EIA Referenced Taped Component Dimensions

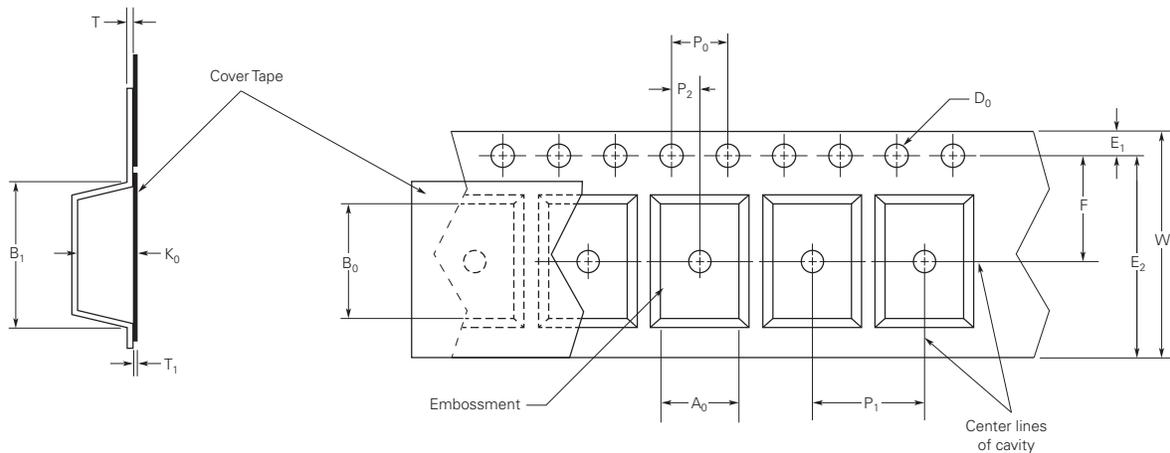
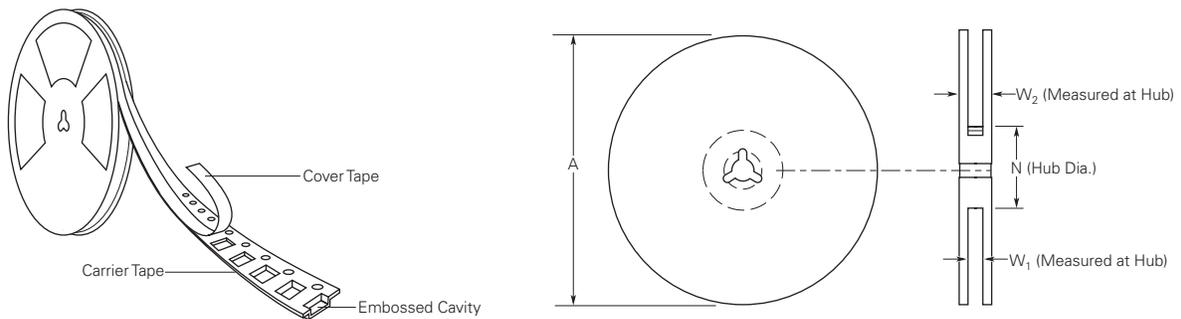
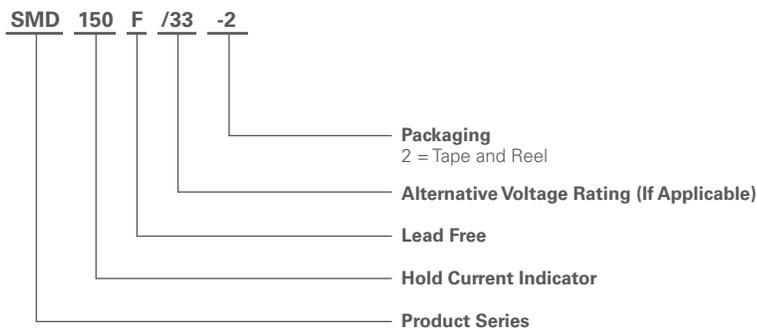

Figure S19 – EIA Referenced Reel Dimensions



## Part Numbering System



## Warning :

- Users should independently evaluate the suitability of and test each product selected for their own application.
- Operation beyond the maximum ratings or improper use may result in device damage and possible electrical arcing and flame.
- These devices are intended for protection against damage caused by occasional overcurrent or overtemperature fault conditions and should not be used when repeated fault conditions or prolonged trip events are anticipated.
- Contamination of the PPTC material with certain silicone-based oils or some aggressive solvents can adversely impact the performance of the devices.
- Device performance can be impacted negatively if devices are handled in a manner inconsistent with recommended electronic, thermal, and mechanical procedures for electronic components.
- PPTC devices are not recommended for installation in applications where the device is constrained such that its PTC properties are inhibited, for example in rigid potting materials or in rigid housings, which lack adequate clearance to accommodate device expansion.
- Operation in circuits with a large inductance can generate a circuit voltage ( $Ldi/dt$ ) above the rated voltage of the device.

## PolySwitch Resettable Devices

### Surface-Mount Devices

#### **Notice:**

Information furnished is believed to be accurate and reliable. However, users should independently evaluate the suitability of and test each product selected for their own applications. Littelfuse products are not designed for, and shall not be used for, any purpose (including, without limitation, military, aerospace, medical, life-saving, life-sustaining or nuclear facility applications, devices intended for surgical implant into the body, or any other application in which the failure or lack of desired operation of the product may result in personal injury, death, or property damage) other than those expressly set forth in applicable Littelfuse product documentation. Warranties granted by Littelfuse shall be deemed void for products used for any purpose not expressly set forth in applicable Littelfuse documentation. Littelfuse shall not be liable for any claims or damages arising out of products used in applications not expressly intended by Littelfuse as set forth in applicable Littelfuse documentation. The sale and use of Littelfuse products is subject to Littelfuse Terms and Conditions of Sale, unless otherwise agreed by Littelfuse.

# PolySwitch Resettable Devices

## Surface-Mount Devices

Компания «Life Electronics» занимается поставками электронных компонентов импортного и отечественного производства от производителей и со складов крупных дистрибьюторов Европы, Америки и Азии.

С конца 2013 года компания активно расширяет линейку поставок компонентов по направлению коаксиальный кабель, кварцевые генераторы и конденсаторы (керамические, пленочные, электролитические), за счёт заключения дистрибьюторских договоров

Мы предлагаем:

- Конкурентоспособные цены и скидки постоянным клиентам.
- Специальные условия для постоянных клиентов.
- Подбор аналогов.
- Поставку компонентов в любых объемах, удовлетворяющих вашим потребностям.
- Приемлемые сроки поставки, возможна ускоренная поставка.
- Доставку товара в любую точку России и стран СНГ.
- Комплексную поставку.
- Работу по проектам и поставку образцов.
- Формирование склада под заказчика.
- Сертификаты соответствия на поставляемую продукцию (по желанию клиента).
- Тестирование поставляемой продукции.
- Поставку компонентов, требующих военную и космическую приемку.
- Входной контроль качества.
- Наличие сертификата ISO.

В составе нашей компании организован Конструкторский отдел, призванный помогать разработчикам, и инженерам.

Конструкторский отдел помогает осуществить:

- Регистрацию проекта у производителя компонентов.
- Техническую поддержку проекта.
- Защиту от снятия компонента с производства.
- Оценку стоимости проекта по компонентам.
- Изготовление тестовой платы монтаж и пусконаладочные работы.



Тел: +7 (812) 336 43 04 (многоканальный)  
Email: [org@lifeelectronics.ru](mailto:org@lifeelectronics.ru)