

## Ultra-small, Low-cost, Push-operated Switches

- All-in-one design means fewer parts are required. This product delivers high reliability at a low cost.
- Uses long-lasting resin springs to achieve a long mechanical durability expectancy of 30,000 operations.
- Models with stoppers for restricting the setting range are available.
- The series includes a complete range of pen-push models that prevent accidental operation.

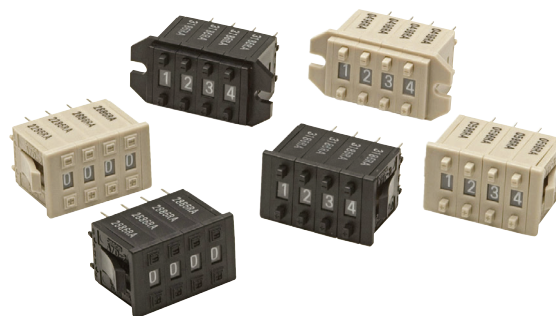

## Ordering Information

### Switches (Single Switch Units)

Model	A7D				A7DP	
	Screw mounting (back mounting)		Snap-in (front mounting)		Snap-in (front mounting)	
Classification (See note 1.)						
Output code	PCB terminals					
Terminals						
Color	Light gray	Black	Light gray	Black	Light gray	Black
06 (binary coded decimal)	A7D-106	A7D-106-1	A7D-206	A7D-206-1	A7DP-206	A7DP-206-1

Note: 1. The classification diagrams show 4 Switch Units combined with End Caps to create 4-digit displays.

2. The model numbers given above are for 1 Switch Unit.

3. Models with stoppers are also available. Add "-S□□" after the "106" or "206" in the model number and specify the display range in the □□. For example, to specify the range 0 to 6, add "-S06" to the model number (e.g., A7D-106-S06-1).

4. Models with +, - displays are also available. Add "-PM" after the "106" or "206" in the model number (e.g., A7D-106-PM or A7D-106-PM-1).

### Accessories (Order Separately)

Use accessories, such as End Caps and Spacers, with the Switch Units.

Classification	Screw mounting (back mounting)		Snap-in (front mounting)	
	Light gray	Black	Light gray	Black
Accessory				
Color				
End Caps (1 pair)	A7D-1M *	A7D-1M-1 *	A7D-2M *	A7D-2M-1 *
Spacer	A7D-1P□ (See note.)	A7D-1P□-1 (See note.)	A7D-2P□ (See note.)	A7D-2P□-1 (See note.)

Note: The □ in the Spacer model number stands for a letter in the range A to U. (Refer to the table in the following explanation about Spacers.)

\* The minimum order is for 10 End Caps.

### End Caps

End Caps are used on the Switch Units at each end and allow all the Switch Units to be securely mounted to a panel. They come in pairs, one for the left and one for the right.

### Spacers

- Spacers are used for creating extra space or gaps between the Switch Units and have the same dimensions as the Switch Units themselves.
- There are also Spacers with engraved characters or symbols that can be used for indicating units, such as time and length. (Refer to the following table.) Consult your OMRON representative for details.

Symbol	A	B	C	D	E	F	G
Stamp	No designation	SEC	MIN	H	g	kg	mm

Symbol	H	J	K	L	Q	T	U
Stamp	cm	m	°C	PCS	x 10 SEC	0	•

# Specifications

<b>Switching capacity (resistive load)</b>		5 to 30 VDC 1 mA to 0.1 A
<b>Continuous carry current</b>		100 mA
<b>Contact resistance</b>		200 mΩ max.
<b>Insulation resistance</b>	<b>Between non-connected terminals</b>	10 MΩ min. (at 250 VDC)
	<b>Between terminal and non-current carrying part</b>	100 MΩ min. (at 500 VDC)
<b>Dielectric strength</b>	<b>Between non-connected terminals</b>	250 VAC, 50/60 Hz for 1 min
	<b>Between terminal and non-current carrying part</b>	1,000 VAC, 50/60 Hz for 1 min
<b>Vibration resistance</b>		10 to 55 Hz, 1.5-mm double amplitude
<b>Shock resistance</b>		500 m/s <sup>2</sup> min.
<b>Durability</b>	<b>Mechanical</b>	30,000 operations min.
	<b>Electrical</b>	20,000 operations min.
<b>Ambient temperature</b>		Operating: -10°C to 70°C (with no icing) Storage: -20°C to 80°C
<b>Ambient humidity</b>		Operating: 45% to 85%
<b>Max. operating force</b>		3.43 N max.

# Dimensions

(Unit: mm)

## Switches

### A7D-106(-1) PCB Terminals



Number of Switches (n)	Size A (n x 5.1 + 3)	Size B (n x 5.1 + 8.3)	Size C (n x 5.1 + 13.3)	Size D
1	8.1	13.4	18.4	8.4
2	13.2	18.5	23.5	13.5
3	18.3	23.6	28.6	18.6
4	23.4	28.7	33.7	23.7
5	28.5	33.8	38.8	28.8
6	33.5	38.9	43.9	33.9
7	38.6	44.0	49.0	39.0
8	43.7	49.1	54.1	44.1
9	48.8	54.2	59.2	49.2
10	53.9	59.3	64.3	54.3

Note: 1. The dimensions above include both End Caps, and will increase 5.08 mm for each Spacer inserted.  
2. Unless otherwise specified, a tolerance of ±0.4 mm applies to all dimensions. The tolerance for multiple connection is ±(number of units x 0.4) mm.

### A7DP-206(-1) PCB Terminals

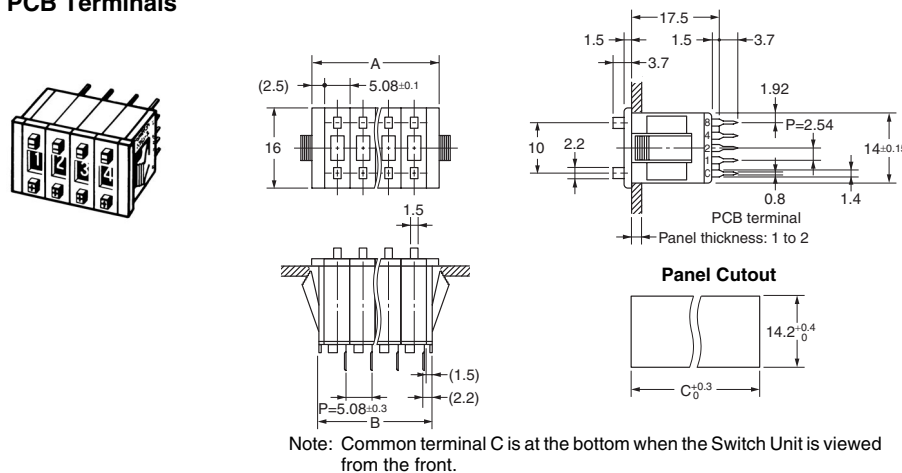

Number of Switches (n)	Size A (n x 5.1 + 5)	Size B (n x 5.1 + 3)	Size C (n x 5.1 + 3.9)
1	10.1	8.1	9
2	15.2	13.2	14.1
3	20.3	18.3	19.2
4	25.4	23.4	24.3
5	30.5	28.5	29.4
6	35.5	33.5	34.5
7	40.6	38.6	39.6
8	45.7	43.7	44.7
9	50.8	48.8	49.8
10	55.9	53.9	54.9

Note: 1. The dimensions above include both End Caps, and will increase 5.08 mm for each Spacer inserted.  
2. Unless otherwise specified, a tolerance of ±0.4 mm applies to all dimensions. The tolerance for multiple connection is ±(number of units x 0.4) mm.

## A7DP-206(-1) PCB Terminals, Pen-push Model



Note: Common terminal C is at the bottom when the Switch Unit is viewed from the front.

Number of Switches (n)	Size A (n x 5.1 + 5)	Size B (n x 5.1 + 3)	Size C (n x 5.1 + 3.9)
1	10.1	8.1	9
2	15.2	13.2	14.1
3	20.3	18.3	19.2
4	25.4	23.4	24.3
5	30.5	28.5	29.4
6	35.5	33.5	34.5
7	40.6	38.6	39.6
8	45.7	43.7	44.7
9	50.8	48.8	49.8
10	55.9	53.9	54.9

Note: 1. The dimensions above include both End Caps, and will increase 5.08 mm for each Spacer inserted.  
2. Unless otherwise specified, a tolerance of  $\pm 0.4$  mm applies to all dimensions. The tolerance for multiple connection is  $\pm(\text{number of units} \times 0.4)$  mm.

## Accessories (Order Separately)

### End Caps for Push-operated Switches A7D-1M(-1) Screw Mounting (Back Mounting)

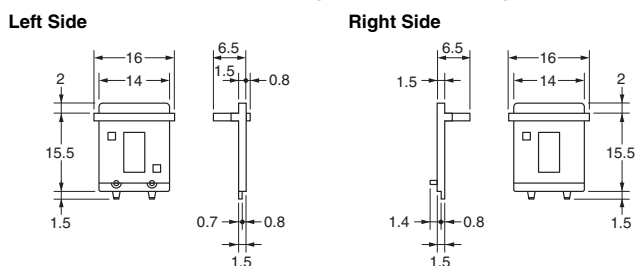

### End Caps for Push-operated Switches A7D-2M(-1) Snap-in Mounting (Front Mounting)

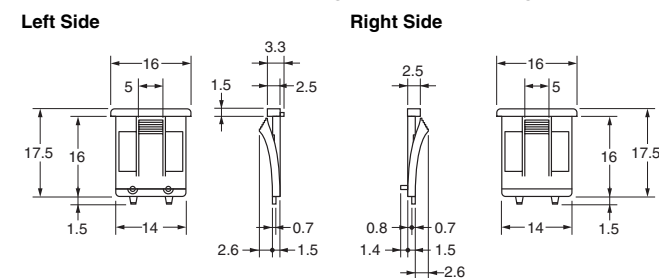

### Spacers for Push-operated Switches A7D-1P□(-1) Screw Mounting (Back Mounting)

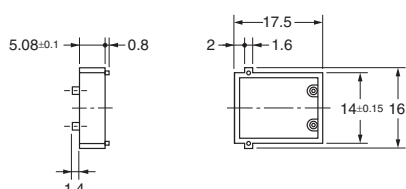

Note: The □ in the Spacer model number stands for a letter in the range A to U. (Refer to the table under the explanation about Spacers on page 1.)

### Spacers for Push-operated Switches A7D-2P□(-1) Snap-in Mounting (Front Mounting)

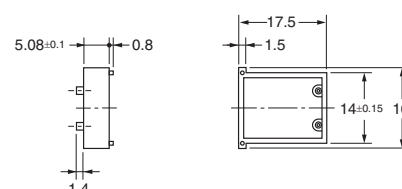

Note: The □ in the Spacer model number stands for a letter in the range A to U. (Refer to the table under the explanation about Spacers on page 1.)

Note: Unless otherwise indicated, dimensional tolerances for dimensions in the models above are  $\pm 0.4$  mm.

## Output Codes

Output code number		06 (Binary Code)				
Internal circuit						
Dial display	Terminal	C	1	2	4	8
0						
1			●			
2				●		
3			●	●		
4					●	
5			●		●	
6				●	●	
7			●	●	●	
8						●
9			●			●

Note: The solid dot ● indicates that the internal switch is ON (i.e., connected to the common terminal).

## Ordering Procedure

Place orders as shown in the example below, specifying the model and number.

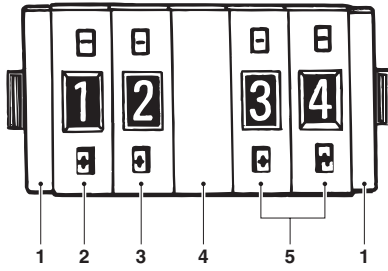

1. A7D-2M (End Caps): 1 pair
2. A7D-206-S□□ (Switch Unit with stopper): 1 piece
3. A7D-206 (Switch Unit): 1 piece
4. A7D-2P□ (Spacer): 1 piece
5. A7D-206 (Switch Unit): 2 pieces

Note: Standard products, such as the Switch Units and End Caps, are not factory-assembled for shipment. Contact your OMRON representative for details on ordering factory-assembled sets.

## Safety Precautions

Refer to *Safety Precautions for All Thumbwheel Switches*.

### Precautions for Correct Use

#### Handling

- The molded components of the Switch use polyacetal resin and PBT resin. It is recommended that alcohol is used to wipe off dirt and smudges from the molded components. Take care to prevent the alcohol from getting inside.
- Do not use thinner or other solutions which might damage the resin.
- Terminals can withstand a force of 4.9 N for 10 seconds or more (the mating strength of the case and seal), and survive bending of 20° without breaking after returning to original position. Do not use excessive force or apply repetitive external force, however, when handling terminals. In particular, take care to avoid dropping them as the terminals might bend or break.



- The setting buttons can withstand 19.6 N for 1 minute, but do not push the (+) and (-) buttons at the same time.

#### Soldering

- Using a Soldering Iron

Use a 30-W soldering iron at a temperature of 350°C for a maximum of 3 seconds, and flush as described above.

Do not apply force to the terminals during soldering and for 3 minutes after soldering is completed. Doing so may result in conduction or operation failure.

Ensure that soldering flux and alcohol do not penetrate into the Switch interior

#### Setting Numbers

##### Pen-push Type

Press the setting switch with the tip of a ball-point pen. Do not use pencil point or mechanical pencil point to press the setting switch, otherwise the lead of the pencil or mechanical pencil may be broken and A7DP malfunctions may result due to fragments of the broken lead.



#### Screw-mounting Models

Tighten mounting screws to a torque between 0.2 to 0.24 N·m, using M2.6 screws. Use plain washers or spring washers together with the screws.

## Read and Understand This Catalog

Please read and understand this catalog before purchasing the products. Please consult your OMRON representative if you have any questions or comments.

## Warranty and Limitations of Liability

### WARRANTY

OMRON's exclusive warranty is that the products are free from defects in materials and workmanship for a period of one year (or other period if specified) from date of sale by OMRON.

OMRON MAKES NO WARRANTY OR REPRESENTATION, EXPRESS OR IMPLIED, REGARDING NON-INFRINGEMENT, MERCHANTABILITY, OR FITNESS FOR PARTICULAR PURPOSE OF THE PRODUCTS. ANY BUYER OR USER ACKNOWLEDGES THAT THE BUYER OR USER ALONE HAS DETERMINED THAT THE PRODUCTS WILL SUITABLY MEET THE REQUIREMENTS OF THEIR INTENDED USE. OMRON DISCLAIMS ALL OTHER WARRANTIES, EXPRESS OR IMPLIED.

### LIMITATIONS OF LIABILITY

OMRON SHALL NOT BE RESPONSIBLE FOR SPECIAL, INDIRECT, OR CONSEQUENTIAL DAMAGES, LOSS OF PROFITS OR COMMERCIAL LOSS IN ANY WAY CONNECTED WITH THE PRODUCTS, WHETHER SUCH CLAIM IS BASED ON CONTRACT, WARRANTY, NEGLIGENCE, OR STRICT LIABILITY.

In no event shall the responsibility of OMRON for any act exceed the individual price of the product on which liability is asserted.

IN NO EVENT SHALL OMRON BE RESPONSIBLE FOR WARRANTY, REPAIR, OR OTHER CLAIMS REGARDING THE PRODUCTS UNLESS OMRON'S ANALYSIS CONFIRMS THAT THE PRODUCTS WERE PROPERLY HANDLED, STORED, INSTALLED, AND MAINTAINED AND NOT SUBJECT TO CONTAMINATION, ABUSE, MISUSE, OR INAPPROPRIATE MODIFICATION OR REPAIR.

## Application Considerations

### SUITABILITY FOR USE

OMRON shall not be responsible for conformity with any standards, codes, or regulations that apply to the combination of products in the customer's application or use of the products.

At the customer's request, OMRON will provide applicable third party certification documents identifying ratings and limitations of use that apply to the products. This information by itself is not sufficient for a complete determination of the suitability of the products in combination with the end product, machine, system, or other application or use.

The following are some examples of applications for which particular attention must be given. This is not intended to be an exhaustive list of all possible uses of the products, nor is it intended to imply that the uses listed may be suitable for the products:

- Outdoor use, uses involving potential chemical contamination or electrical interference, or conditions or uses not described in this catalog.
- Nuclear energy control systems, combustion systems, railroad systems, aviation systems, medical equipment, amusement machines, vehicles, safety equipment, and installations subject to separate industry or government regulations.
- Systems, machines, and equipment that could present a risk to life or property.

Please know and observe all prohibitions of use applicable to the products.

NEVER USE THE PRODUCTS FOR AN APPLICATION INVOLVING SERIOUS RISK TO LIFE OR PROPERTY WITHOUT ENSURING THAT THE SYSTEM AS A WHOLE HAS BEEN DESIGNED TO ADDRESS THE RISKS, AND THAT THE OMRON PRODUCTS ARE PROPERLY RATED AND INSTALLED FOR THE INTENDED USE WITHIN THE OVERALL EQUIPMENT OR SYSTEM.

### PROGRAMMABLE PRODUCTS

OMRON shall not be responsible for the user's programming of a programmable product, or any consequence thereof.

## Disclaimers

### CHANGE IN SPECIFICATIONS

Product specifications and accessories may be changed at any time based on improvements and other reasons.

It is our practice to change model numbers when published ratings or features are changed, or when significant construction changes are made. However, some specifications of the products may be changed without any notice. When in doubt, special model numbers may be assigned to fix or establish key specifications for your application on your request. Please consult with your OMRON representative at any time to confirm actual specifications of purchased products.

### DIMENSIONS AND WEIGHTS

Dimensions and weights are nominal and are not to be used for manufacturing purposes, even when tolerances are shown.

### PERFORMANCE DATA

Performance data given in this catalog is provided as a guide for the user in determining suitability and does not constitute a warranty. It may represent the result of OMRON's test conditions, and the users must correlate it to actual application requirements. Actual performance is subject to the OMRON Warranty and Limitations of Liability.

### ERRORS AND OMISSIONS

The information in this document has been carefully checked and is believed to be accurate; however, no responsibility is assumed for clerical, typographical, or proofreading errors, or omissions.

2008.12

In the interest of product improvement, specifications are subject to change without notice.

**OMRON Corporation**  
Industrial Automation Company

<http://www.ia.omron.com/>

(c)Copyright OMRON Corporation 2008 All Right Reserved.

Компания «Life Electronics» занимается поставками электронных компонентов импортного и отечественного производства от производителей и со складов крупных дистрибьюторов Европы, Америки и Азии.

С конца 2013 года компания активно расширяет линейку поставок компонентов по направлению коаксиальный кабель, кварцевые генераторы и конденсаторы (керамические, пленочные, электролитические), за счёт заключения дистрибьюторских договоров

Мы предлагаем:

- Конкурентоспособные цены и скидки постоянным клиентам.
- Специальные условия для постоянных клиентов.
- Подбор аналогов.
- Поставку компонентов в любых объемах, удовлетворяющих вашим потребностям.
- Приемлемые сроки поставки, возможна ускоренная поставка.
- Доставку товара в любую точку России и стран СНГ.
- Комплексную поставку.
- Работу по проектам и поставку образцов.
- Формирование склада под заказчика.
- Сертификаты соответствия на поставляемую продукцию (по желанию клиента).
- Тестирование поставляемой продукции.
- Поставку компонентов, требующих военную и космическую приемку.
- Входной контроль качества.
- Наличие сертификата ISO.

В составе нашей компании организован Конструкторский отдел, призванный помогать разработчикам, и инженерам.

Конструкторский отдел помогает осуществить:

- Регистрацию проекта у производителя компонентов.
- Техническую поддержку проекта.
- Защиту от снятия компонента с производства.
- Оценку стоимости проекта по компонентам.
- Изготовление тестовой платы монтаж и пусконаладочные работы.



Тел: +7 (812) 336 43 04 (многоканальный)

Email: [org@lifeelectronics.ru](mailto:org@lifeelectronics.ru)