

# Energy-saving axial fans

version 03/2009



The engineer's choice

**ebmpapst**

# New energy-saving axial fans

## The new generation of compact energy-saving axial fans

In almost all spheres of life, energy savings have become an important issue by now. Our new and compact axial fans are based on the energy-saving motor (ESM) and offer high efficiency and thus considerable energy savings and improved service life at the same time - aspects which are definitely called for with refrigeration plants, such as refrigerated display cases or refrigeration chests or condensing units.

The axial fan W1G 200 already established quite successfully on the market has now been complemented by the sizes 172, 230, 250 and 300 mm. The new plastic rotor was optimised to meet improved aerodynamic criteria and makes these fans operate even more quietly. What is more, they environment benefits from the fact that no varnish needs to be used any more!

Compared to conventional shaded pole motors, energy-saving motors are three times as efficient. Higher efficiency translates into less intrinsic heat generated during operation, with a reduced need to dissipate heat and putting a strain on the environment. This results in further energy savings, as less refrigeration capacity has to be applied in the first instance.

The new and compact energy-saving axial fans, with an output power of between 5 and 20 W, can be easily connected via a plug-in connection. Moreover, the motor speed can be optionally set via programming interface. A second speed step - e.g. for night setback, can be realised via actuator input.

The energy-saving fans are robust, maintenance-free and durable. Their service life is rated at more than 40,000 hours, equalling continuous operation of more than 4.5 years. As regards environmental impacts, their design complies with protection type IP 54 specifications. Optionally, protection type IP 65 is available. Moreover, these energy-saving axial fans comply with protection class 2.

## Table of content



■ New energy-saving axial fans	2
■ Size 172	4
■ Size 200	6
■ Size 230	12
■ Size 250	14
■ Size 300	16
■ Connection leads	20
■ ebm-papst representatives & subsidiaries	22

# Energy-saving axial fans

Ø 172



- **Material:** Wall ring: Plastic PP  
Blade: Plastic PA
- **Number of blades:** 5
- **Direction of air flow:** "V", exhaust over struts
- **Direction of rotation:** Counter-clockwise seen on rotor
- **Type of protection:** IP 54
- **Insulation class:** "B"
- **Mounting position:** Any
- **Condensate discharges:** None
- **Mode of operation:** Continuous operation (S1)
- **Bearings:** Maintenance-free ball bearings
- **Motor protection:** Via electronics and TOP
- **Electrical connection:** Line cord with plug
- **Protection class:** II
- **Product conforming to standard:** CE
- **Approvals:** VDE; UL, CSA is applied for
- **Speed:** Using the programming unit, 2 speeds between  $n_{min}$  and  $n_{max}$  can be programmed.

## Nominal data

Type	Motor	Curve	Nominal voltage VAC	Frequency Hz	Speed (1) rpm	Max. Power input (1) W	Max. Current draw (1) A	Max. operative range Pa	Perm. amb. temp. °C	Mass kg
<b>W1G172-EC95 -01</b>	M1G 055-BD	A	115	50/60	2400	22	0,34	55	-30..+50	0,95
<b>W1G172-EC91 -01</b>	M1G 055-BD	B	230	50/60	2400	22	0,17	55	-30..+50	0,95

subject to alterations

(1) Nominal data in operating point with maximum load and 115 or 230 VAC

## Curves

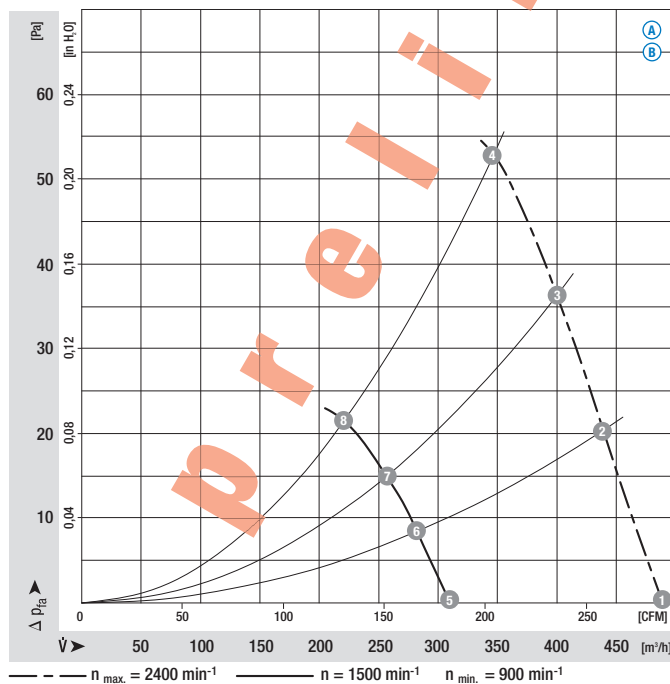

	n [rpm]	P <sub>1</sub> [W]	I [A]	Lp <sub>A</sub> [dB(A)]
A 1	2400	19	0,30	53
A 2	2400	21	0,32	53
A 3	2400	22	0,34	53
A 4	2400	22	0,34	53
A 5	1500	8	0,12	42
A 6	1500	8	0,14	43
A 7	1500	9	0,14	43
A 8	1500	9	0,14	44
B 1	2400	19	0,15	53
B 2	2400	21	0,16	53
B 3	2400	22	0,17	53
B 4	2400	22	0,17	53
B 5	1500	8	0,06	42
B 6	1500	8	0,07	43
B 7	1500	9	0,07	43
B 8	1500	9	0,07	44

- Electr. connection:

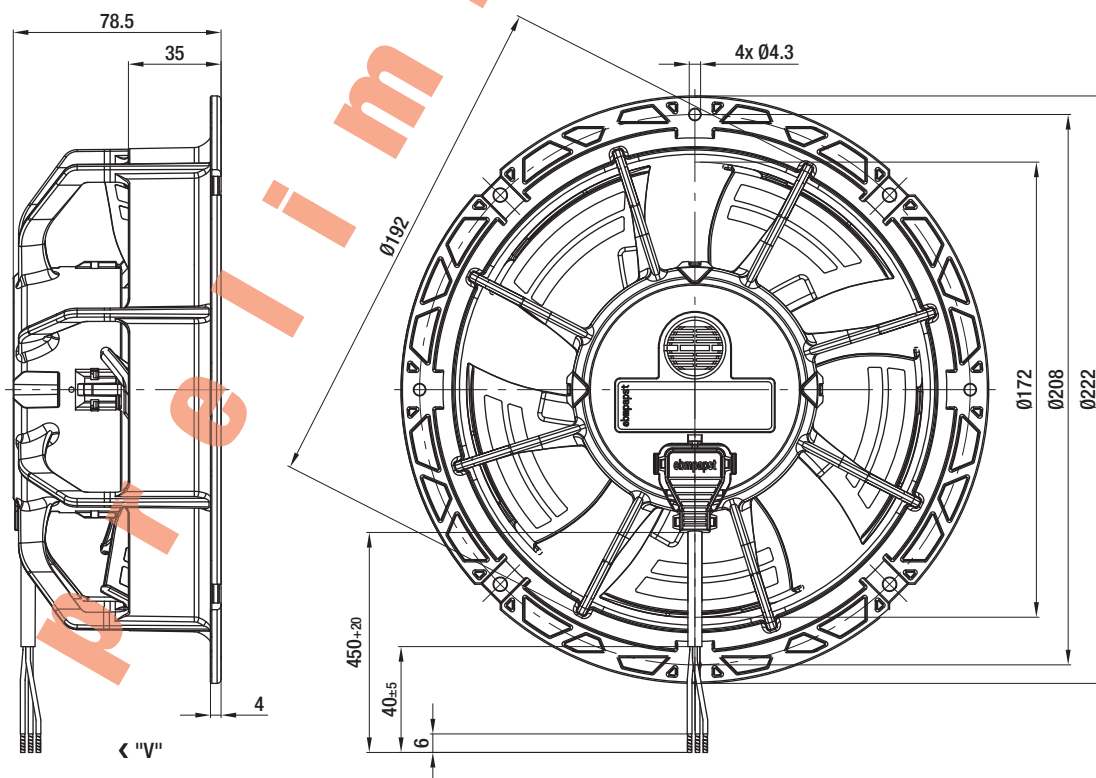
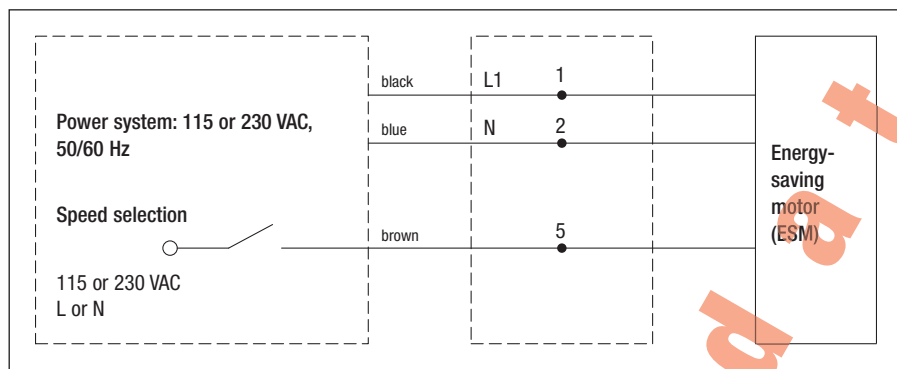

# Energy-saving axial fans

Ø 200



- **Material:** Wall ring: Plastic PP  
Blade: Plastic PA
- **Number of blades:** 5
- **Direction of air flow:** "V", exhaust over struts
- **Direction of rotation:** Counter-clockwise seen on rotor
- **Type of protection:** IP 54
- **Insulation class:** "B"
- **Mounting position:** Any
- **Condensate discharges:** None
- **Mode of operation:** Continuous operation (S1)
- **Bearings:** Maintenance-free ball bearings
- **Motor protection:** Via electronics and TOP
- **Electrical connection:** Line cord with plug
- **Protection class:** II
- **Product conforming to standard:** CE
- **Approvals:** VDE;  
UL, CSA is applied for
- **Speed:** Using the programming unit, 2 speeds between  $n_{min}$  and  $n_{max}$  can be programmed.

Nominal data		Curve	Nominal voltage	Frequency	Speed <sup>(1)</sup>	Max. Power input <sup>(1)</sup>	Max. Current draw <sup>(1)</sup>	Max. operative range	Perm. amb. temp.	Mass
Type	Motor	VAC	Hz	rpm	W	A	Pa	°C	kg	
<b>W1G200-EC91 -27</b>	M1G 055-BD	A	115	50/60	1300	8,0	0,11	24	-30..+50	1,0
<b>W1G200-EC87 -25</b>	M1G 055-BD	B	230	50/60	1300	8,5	0,07	24	-30..+50	1,0

subject to alterations

<sup>(1)</sup> Nominal data in operating point with maximum load and 115 or 230 VAC

## Curves

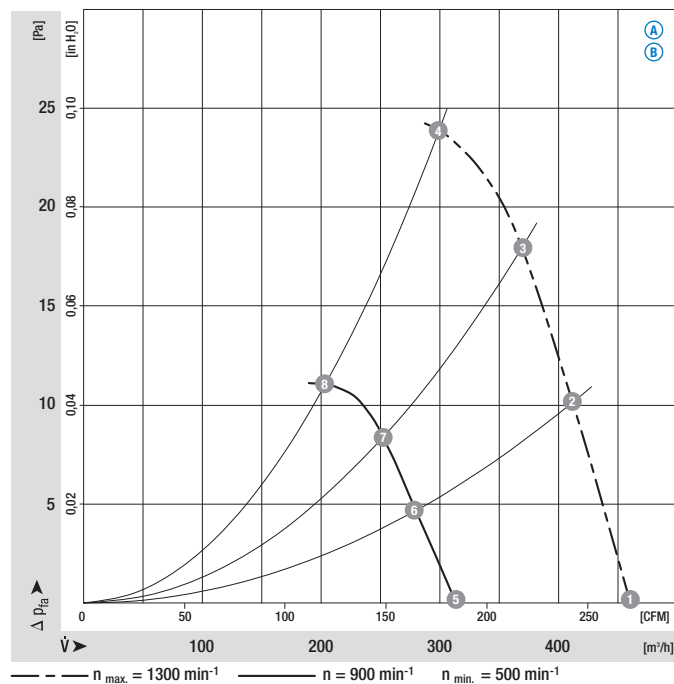

	n [rpm]	P <sub>1</sub> [W]	I [A]	Lp <sub>A</sub> [dB(A)]
A 1	1300	7	0,09	42
A 2	1300	8	0,10	41
A 3	1300	8	0,10	41
A 4	1300	8	0,11	42
A 5	900	3	0,05	33
A 6	900	4	0,05	32
A 7	900	4	0,05	32
A 8	900	4	0,05	33
B 1	1300	7	0,06	42
B 2	1300	8	0,07	41
B 3	1300	8,5	0,07	41
B 4	1300	8,5	0,07	42
B 5	900	3	0,03	33
B 6	900	4	0,04	32
B 7	900	4	0,04	32
B 8	900	4	0,04	33

– Electr. connection:

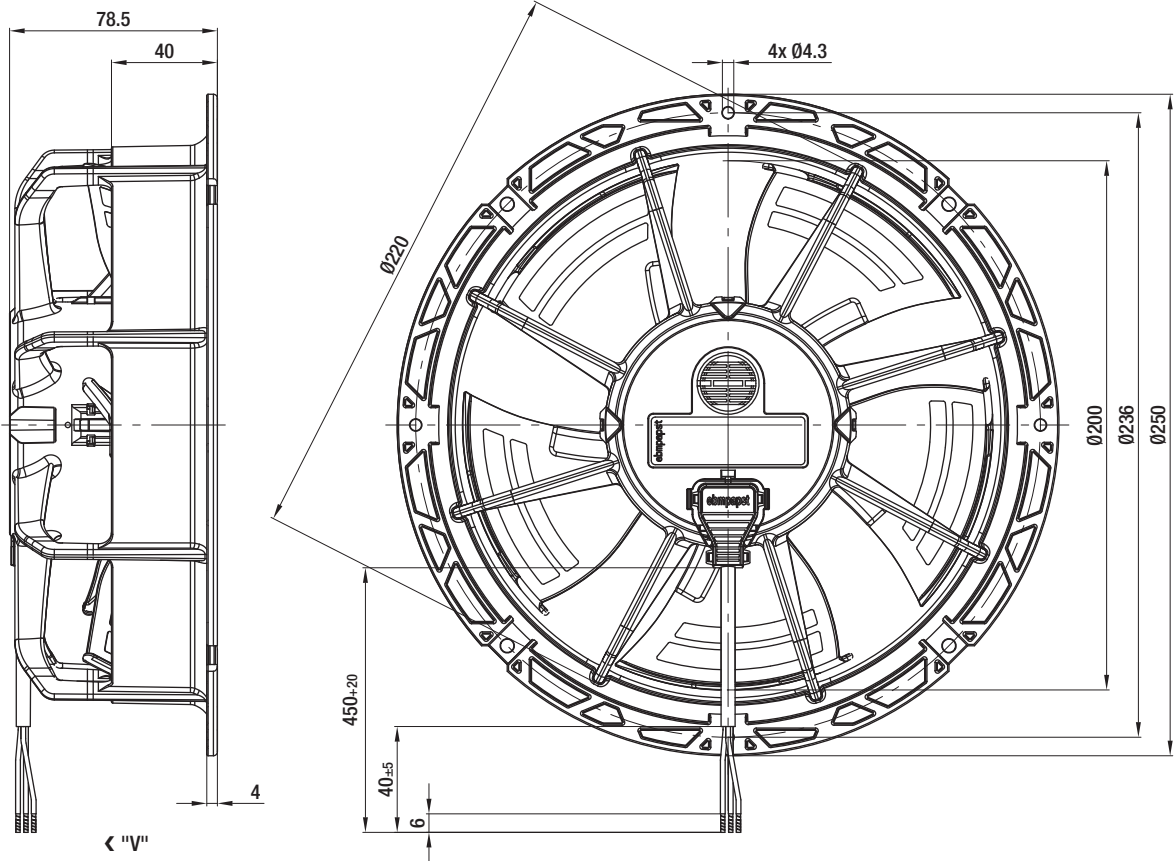

# Energy-saving axial fans

Ø 200



- **Material:** Wall ring: Plastic PP  
Blade: Plastic PA
- **Number of blades:** 5
- **Direction of air flow:** "V", exhaust over struts
- **Direction of rotation:** Counter-clockwise seen on rotor
- **Type of protection:** IP 54
- **Insulation class:** "B"
- **Mounting position:** Any
- **Condensate discharges:** None
- **Mode of operation:** Continuous operation (S1)
- **Bearings:** Maintenance-free ball bearings
- **Motor protection:** Via electronics and TOP
- **Electrical connection:** Line cord with plug
- **Protection class:** II
- **Product conforming to standard:** CE
- **Approvals:** VDE;  
UL, CSA is applied for
- **Speed:** Using the programming unit, 2 speeds between  $n_{min}$  and  $n_{max}$  can be programmed.

Nominal data		Curve	Nominal voltage	Frequency	Speed <sup>(1)</sup>	Max. Power input <sup>(1)</sup>	Max. Current draw <sup>(1)</sup>	Max. operative range	Perm. amb. temp.	Mass
Type	Motor	VAC	Hz	rpm	W	A	Pa	°C	kg	
<b>W1G200-EC95 -47</b>	M1G 055-BD	A	115	50/60	2100	31	0,48	55	-30..+50	1,0
<b>W1G200-EC91 -45</b>	M1G 055-BD	B	230	50/60	2100	31	0,24	55	-30..+50	1,0

subject to alterations

<sup>(1)</sup> Nominal data in operating point with maximum load and 115 or 230 VAC

## Curves

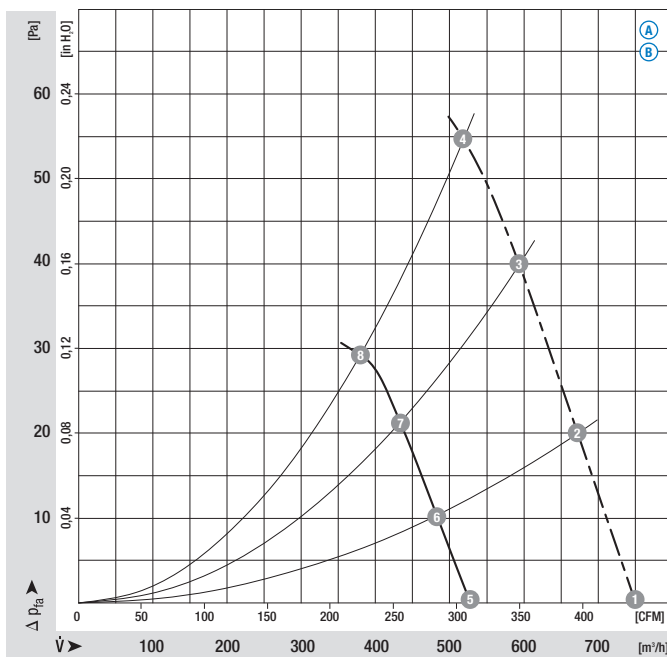

	n [rpm]	P <sub>1</sub> [W]	I [A]	Lp <sub>A</sub> [dB(A)]
A 1	2100	29	0,44	55
A 2	2100	30	0,46	54
A 3	2100	31	0,48	53
A 4	2100	31	0,48	55
A 5	1500	14	0,22	46
A 6	1500	16	0,24	45
A 7	1500	16	0,26	45
A 8	1500	16	0,26	46
B 1	2100	29	0,22	55
B 2	2100	30	0,23	54
B 3	2100	31	0,24	53
B 4	2100	31	0,24	55
B 5	1500	14	0,11	46
B 6	1500	16	0,12	45
B 7	1500	16	0,13	45
B 8	1500	16	0,13	46



– Electr. connection:

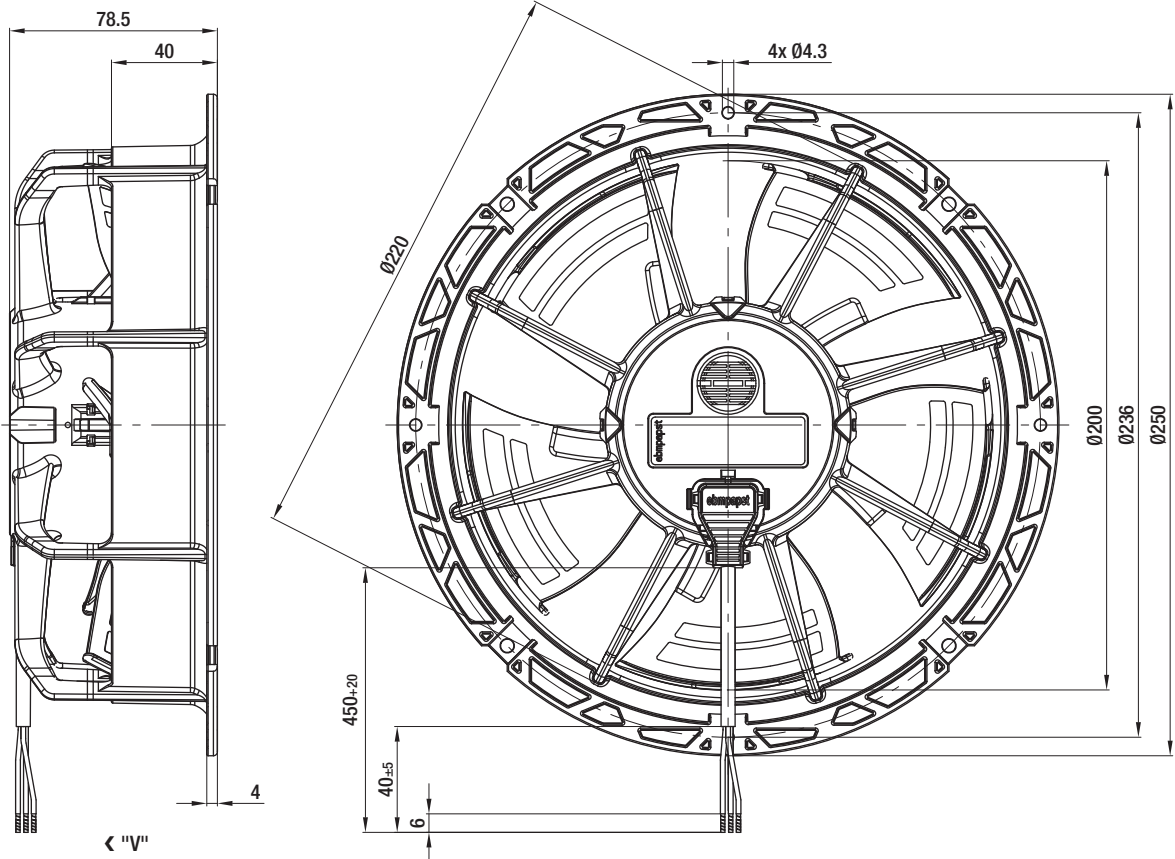
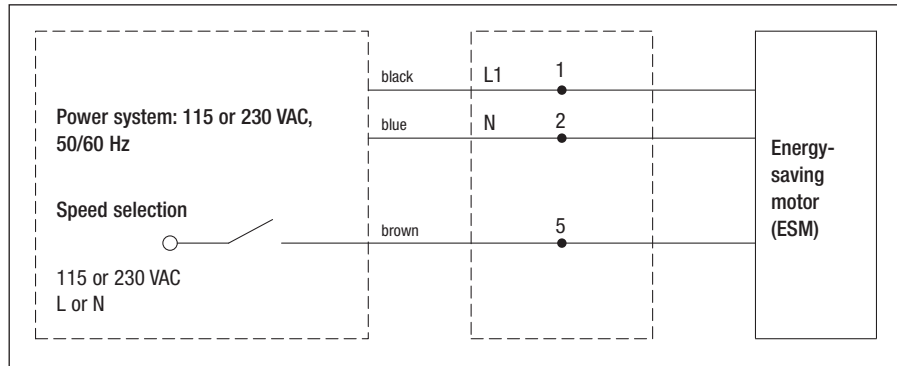

# Energy-saving axial fans

Ø 200

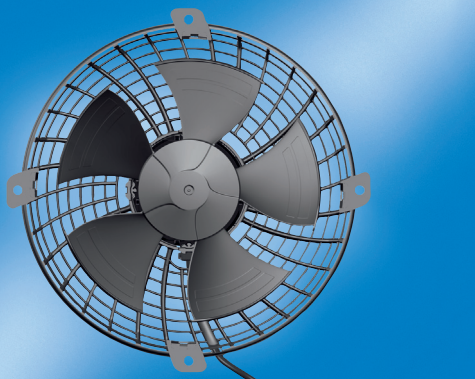

- **Material:** Blade: Plastic PA  
Guard grille: Plastic PP
- **Number of blades:** 5
- **Direction of air flow:** "A", intake over guard grille
- **Direction of rotation:** Counter-clockwise seen on rotor
- **Type of protection:** IP 54
- **Insulation class:** "B"
- **Mounting position:** Any
- **Condensate discharges:** None
- **Mode of operation:** Continuous operation (S1)
- **Bearings:** Maintenance-free ball bearings
- **Motor protection:** Via electronics and TOP
- **Electrical connection:** Line cord with plug
- **Protection class:** II
- **Product conforming to standard:** CE
- **Approvals:** VDE; UL, CSA is applied for
- **Speed:** Using the programming unit, 2 speeds between  $n_{min}$  and  $n_{max}$  can be programmed.

Nominal data		Curve	Nominal voltage	Frequency	Speed <sup>(1)</sup>	Max. Power input <sup>(1)</sup>	Max. Current draw <sup>(1)</sup>	Max. operative range	Perm. amb. temp.	Mass
Type	Motor	VAC	Hz	rpm	W	A	Pa	°C	kg	
<b>S1G 200-CA95 -02</b>	M1G 055-BD	A	115	50/60	2000	31	0,43	45	-30..+50	0,95
<b>S1G 200-CA91 -02</b>	M1G 055-BD	B	230	50/60	2000	33,5	0,25	45	-30..+50	0,95

subject to alterations

<sup>(1)</sup> Nominal data in operating point with maximum load and 115 or 230 VAC

## Curves

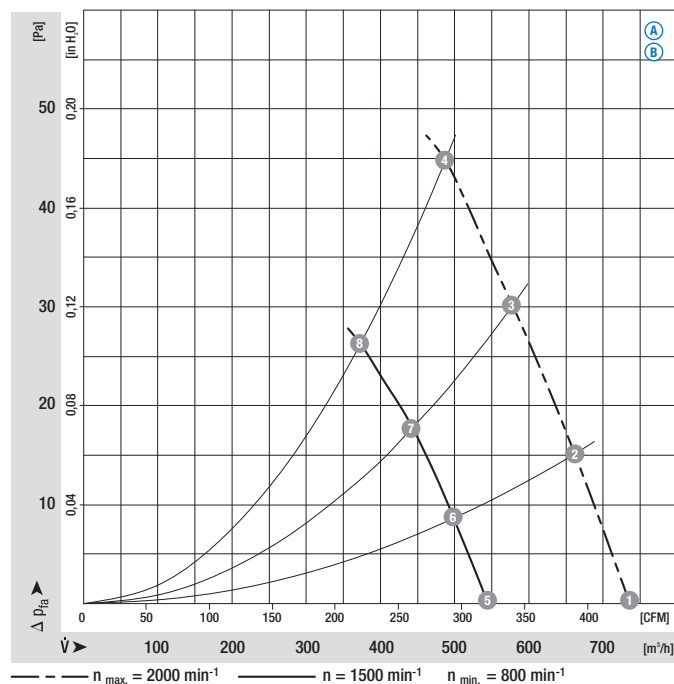

	n [rpm]	P <sub>1</sub> [W]	I [A]	Lp <sub>A</sub> [dB(A)]
A 1	2000	30	0,43	54
A 2	2000	30	0,43	54
A 3	2000	30	0,43	53
A 4	2000	31	0,43	54
A 5	1500	17	0,29	50
A 6	1500	18	0,29	50
A 7	1500	19	0,29	49
A 8	1500	20	0,29	50
B 1	2000	32	0,24	54
B 2	2000	33	0,25	54
B 3	2000	33	0,25	53
B 4	2000	33,5	0,25	54
B 5	1500	18	0,16	50
B 6	1500	19	0,16	50
B 7	1500	19	0,16	49
B 8	1500	20	0,16	50

– Electr. connection:

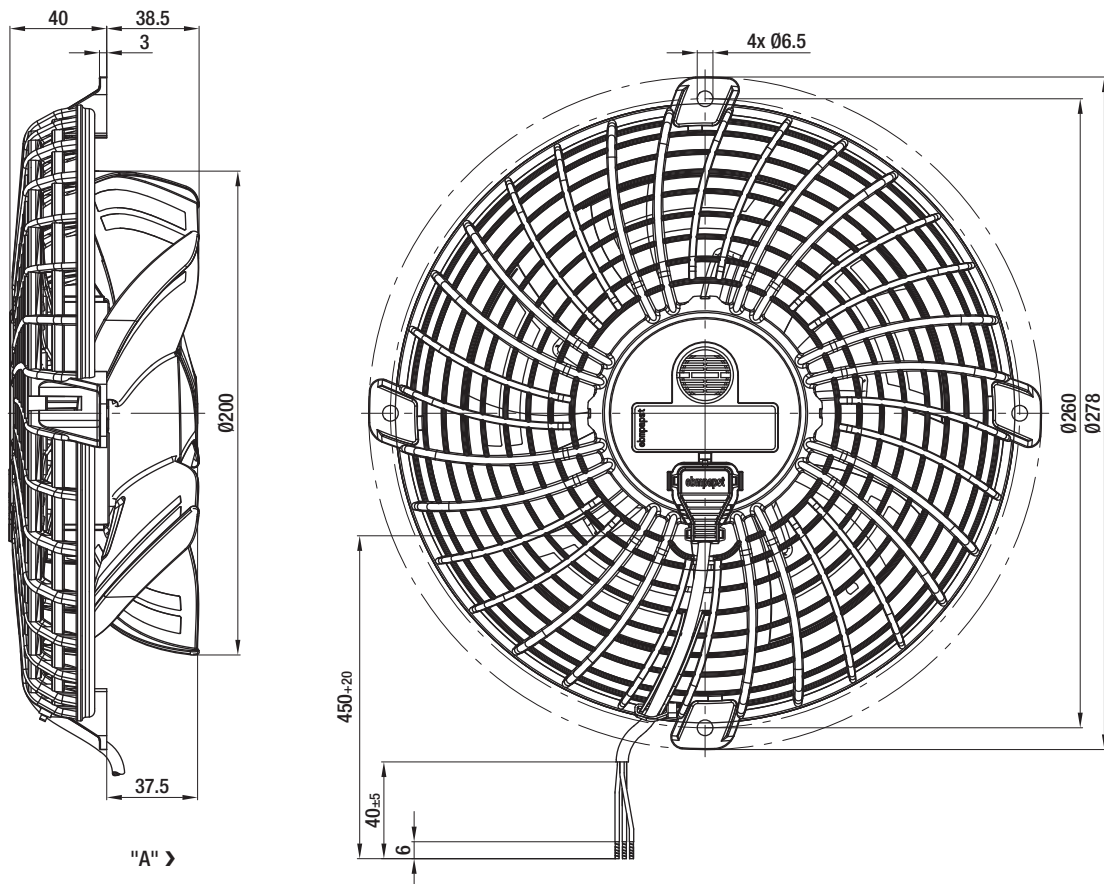
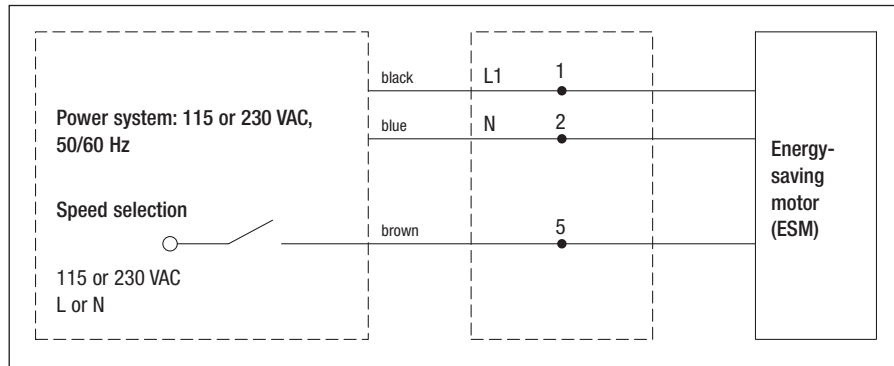

# Energy-saving axial fans

Ø 230



- **Material:** Wall ring: Plastic PP  
Blade: Plastic PA
- **Number of blades:** 5
- **Direction of air flow:** "V", exhaust over struts
- **Direction of rotation:** Counter-clockwise seen on rotor
- **Type of protection:** IP 54
- **Insulation class:** "B"
- **Mounting position:** Any
- **Condensate discharges:** None
- **Mode of operation:** Continuous operation (S1)
- **Bearings:** Maintenance-free ball bearings
- **Motor protection:** Via electronics and TOP
- **Electrical connection:** Line cord with plug
- **Protection class:** II
- **Product conforming to standard:** CE
- **Approvals:** VDE;  
UL, CSA is applied for
- **Speed:** Using the programming unit, 2 speeds between  $n_{min}$  and  $n_{max}$  can be programmed.

Nominal data		Curve	Nominal voltage	Frequency	Speed <sup>(1)</sup>	Max. Power input <sup>(1)</sup>	Max. Current draw <sup>(1)</sup>	Max. operative range	Perm. amb. temp.	Mass
Type	Motor	VAC	Hz	rpm	W	A	Pa	°C	kg	
<b>W1G230-EB97 -01</b>	M1G 055-BD	A	115	50/60	1500	23	0,35	38	-30..+50	1,05
<b>W1G230-EB89 -01</b>	M1G 055-BD	B	230	50/60	1500	26	0,20	38	-30..+50	1,05

subject to alterations

<sup>(1)</sup> Nominal data in operating point with maximum load and 115 or 230 VAC

## Curves

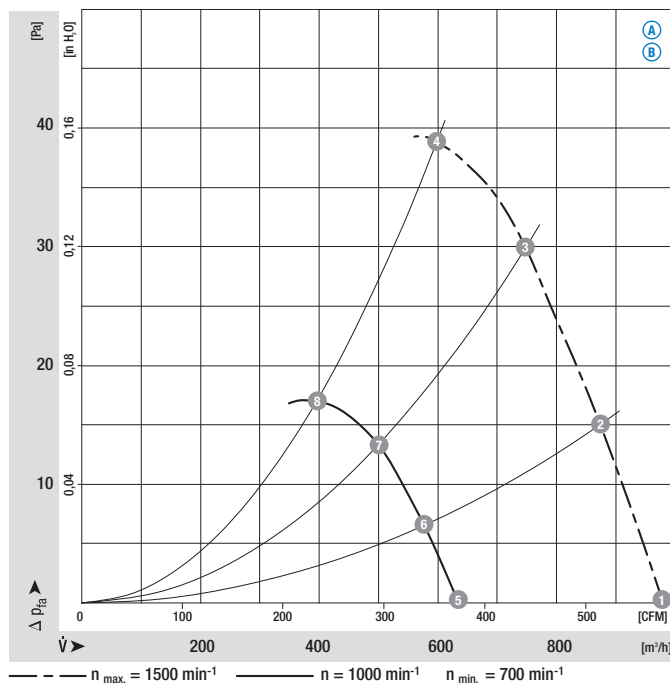

	n [rpm]	P <sub>1</sub> [W]	I [A]	Lp <sub>A</sub> [dB(A)]
A 1	1500	23	0,35	51
A 2	1500	23	0,35	51
A 3	1500	23	0,35	50
A 4	1500	23	0,35	50
A 5	1000	9	0,15	39
A 6	1000	10	0,16	39
A 7	1000	10	0,16	40
A 8	1000	10	0,16	40
B 1	1500	24	0,19	51
B 2	1500	25	0,19	51
B 3	1500	25	0,19	50
B 4	1500	26	0,20	50
B 5	1000	10	0,09	39
B 6	1000	11	0,09	39
B 7	1000	11	0,09	40
B 8	1000	11	0,09	40

– Electr.  
connection:

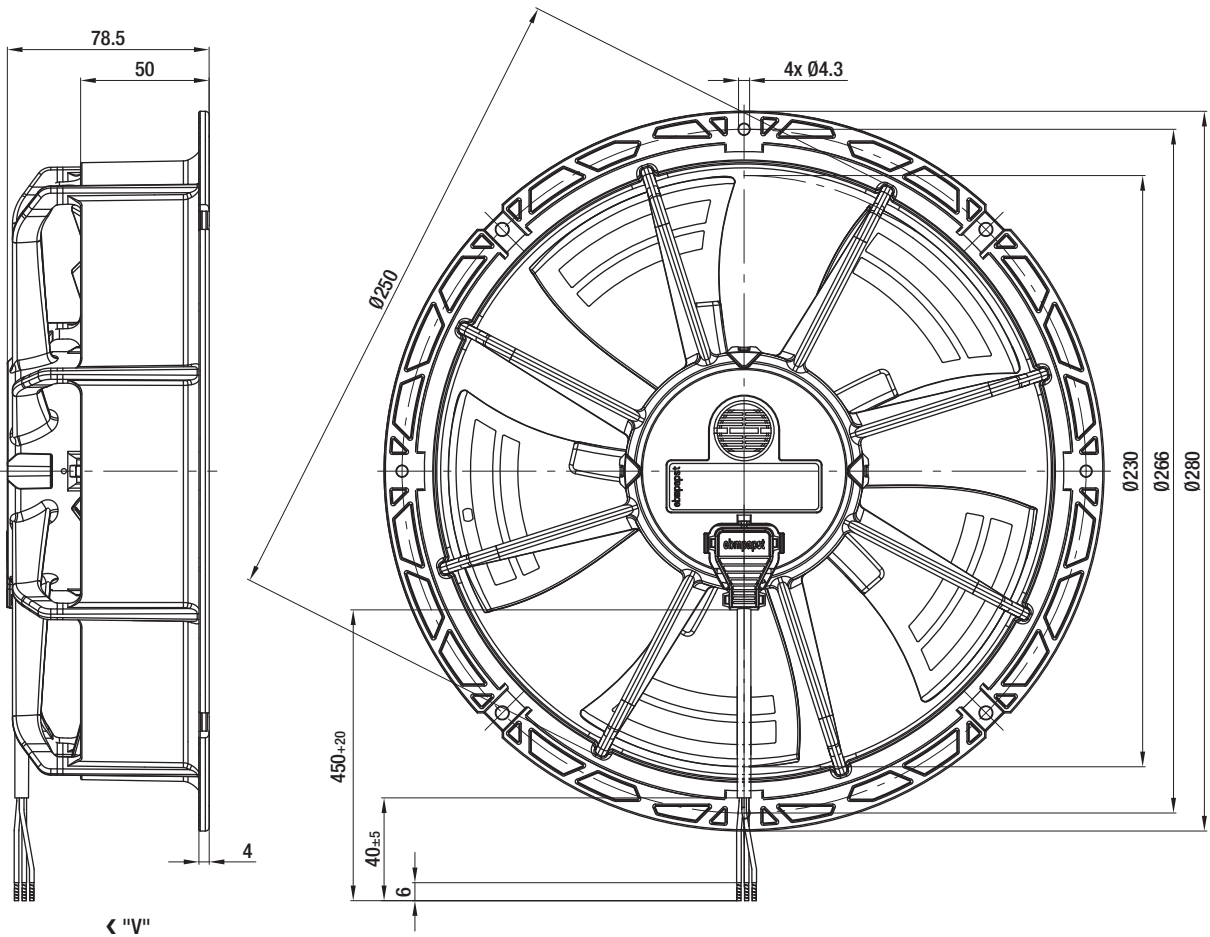
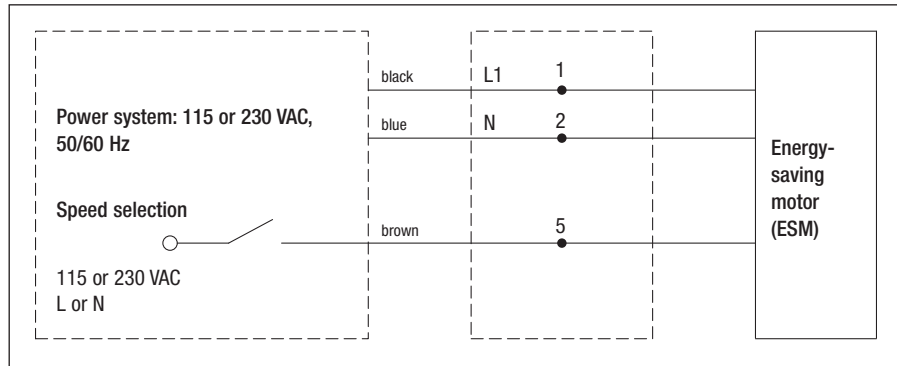

# Energy-saving axial fans

Ø 250



- **Material:** Wall ring: Plastic PP  
Blade: Plastic PA
- **Number of blades:** 5
- **Direction of air flow:** "V", exhaust over struts
- **Direction of rotation:** Counter-clockwise seen on rotor
- **Type of protection:** IP 54
- **Insulation class:** "B"
- **Mounting position:** Any
- **Condensate discharges:** None
- **Mode of operation:** Continuous operation (S1)
- **Bearings:** Maintenance-free ball bearings
- **Motor protection:** Via electronics and TOP
- **Electrical connection:** Line cord with plug
- **Protection class:** II
- **Product conforming to standard:** CE
- **Approvals:** VDE, UL, CSA is applied for
- **Speed:** Using the programming unit, 2 speeds between  $n_{min}$  and  $n_{max}$  can be programmed.

Nominal data		Curve	Nominal voltage	Frequency	Speed <sup>(1)</sup>	Max. Power input <sup>(1)</sup>	Max. Current draw <sup>(1)</sup>	Max. operative range	Perm. amb. temp.	Mass
Type	Motor	VAC	Hz	rpm	W	A	Pa	°C	kg	
<b>W1G250-BB21 -01</b>	M1G 055-BI	A	115	50/60	1700	32	0,47	42	-30..+50	1,55
<b>W1G250-BB17 -01</b>	M1G 055-BI	B	230	50/60	1700	32	0,24	42	-30..+50	1,55

subject to alterations

<sup>(1)</sup> Nominal data in operating point with maximum load and 115 or 230 VAC

## Curves

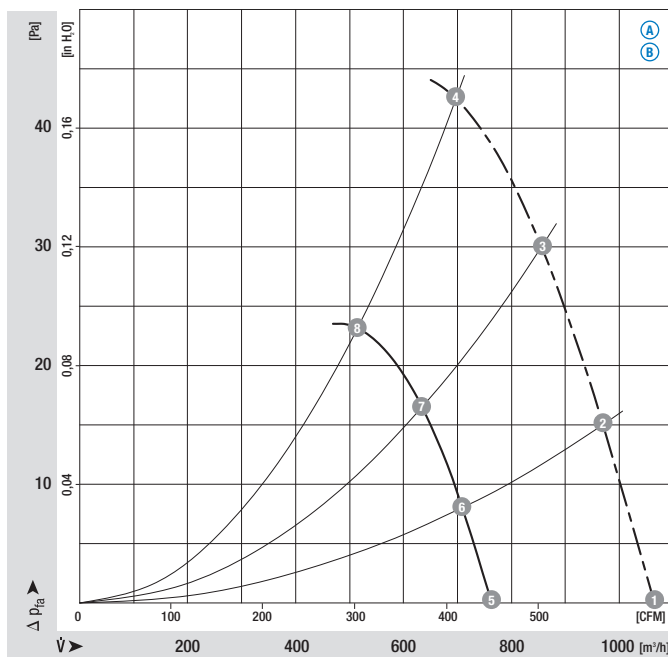

	n [rpm]	P <sub>1</sub> [W]	I [A]	Lp <sub>A</sub> [dB(A)]
A 1	1700	30	0,44	55
A 2	1700	31	0,45	56
A 3	1700	32	0,47	56
A 4	1700	32	0,47	57
A 5	1200	14	0,22	46
A 6	1200	15	0,24	46
A 7	1200	16	0,25	47
A 8	1200	17	0,26	48
B 1	1700	30	0,24	55
B 2	1700	31	0,24	56
B 3	1700	32	0,24	56
B 4	1700	32	0,24	57
B 5	1200	14	0,12	46
B 6	1200	15	0,13	46
B 7	1200	16	0,14	47
B 8	1200	17	0,14	48

– Electr.  
connection:

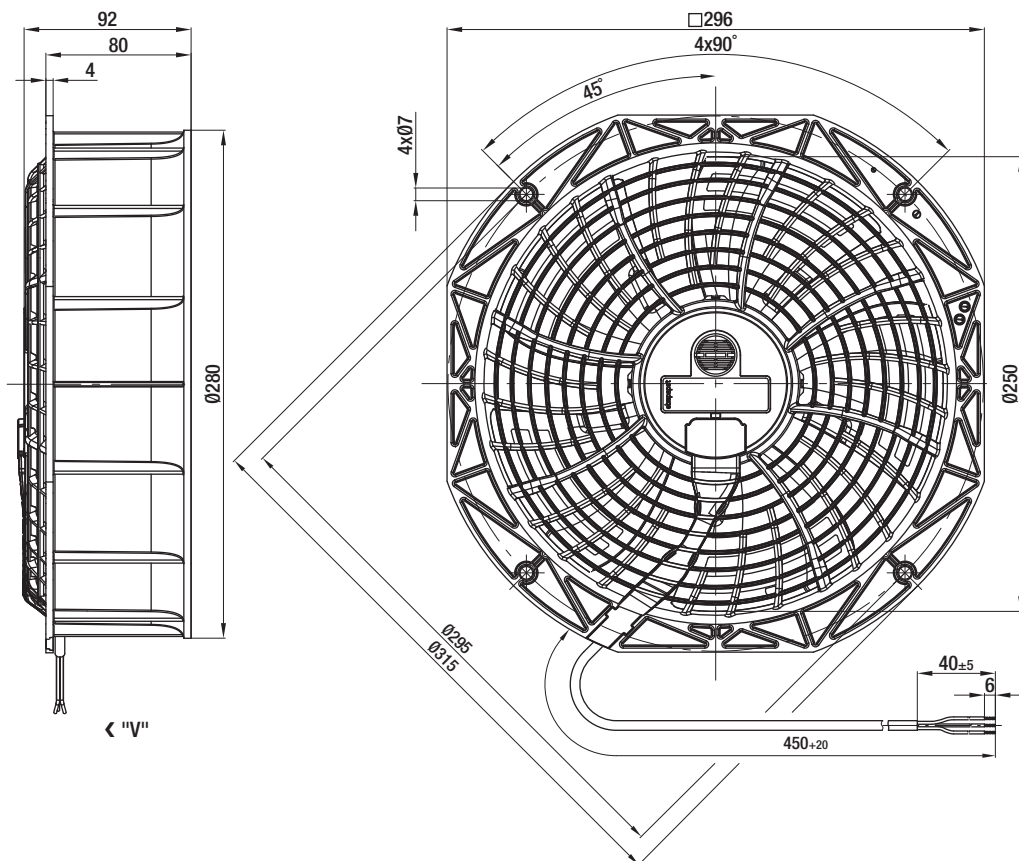

# Energy-saving axial fans

Ø 300



- **Material:** Wall ring: Plastic PP  
Blade: Plastic PA
- **Number of blades:** 5
- **Direction of air flow:** "V", exhaust over struts
- **Direction of rotation:** Counter-clockwise seen on rotor
- **Type of protection:** IP 54
- **Insulation class:** "B"
- **Mounting position:** Any
- **Condensate discharges:** None
- **Mode of operation:** Continuous operation (S1)
- **Bearings:** Maintenance-free ball bearings
- **Motor protection:** Via electronics and TOP
- **Electrical connection:** Line cord with plug
- **Protection class:** II
- **Product conforming to standard:** CE
- **Approvals:** VDE, UL, CSA is applied for
- **Speed:** Using the programming unit, 2 speeds between  $n_{min}$  and  $n_{max}$  can be programmed.

Nominal data		Curve	Nominal voltage	Frequency	Speed <sup>(1)</sup>	Max. Power input <sup>(1)</sup>	Max. Current draw <sup>(1)</sup>	Max. operative range	Perm. amb. temp.	Mass
Type	Motor	VAC	Hz	rpm	W	A	Pa	°C	kg	
<b>W1G300-BB23 -01</b>	M1G 055-BI	A	115	50/60	1300	35	0,50	35	-30..+50	1,75
<b>W1G300-BB19 -01</b>	M1G 055-BI	B	230	50/60	1300	35	0,27	35	-30..+50	1,75

subject to alterations

<sup>(1)</sup> Nominal data in operating point with maximum load and 115 or 230 VAC

## Curves

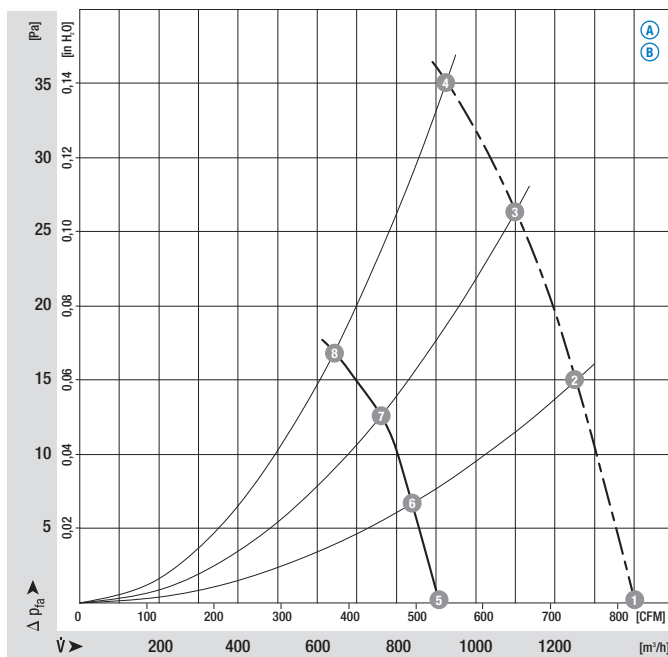

	n [rpm]	P <sub>1</sub> [W]	I [A]	Lp <sub>A</sub> [dB(A)]
A 1	1300	28	0,41	52
A 2	1300	31	0,46	52
A 3	1300	32	0,47	51
A 4	1300	35	0,50	52
A 5	900	12	0,24	43
A 6	900	14	0,26	42
A 7	900	15	0,28	42
A 8	900	16	0,30	43
B 1	1300	32	0,25	52
B 2	1300	34	0,27	52
B 3	1300	34	0,27	51
B 4	1300	35	0,27	52
B 5	900	13	0,12	43
B 6	900	14	0,13	42
B 7	900	15	0,14	42
B 8	900	16	0,15	43



- Electr. connection:

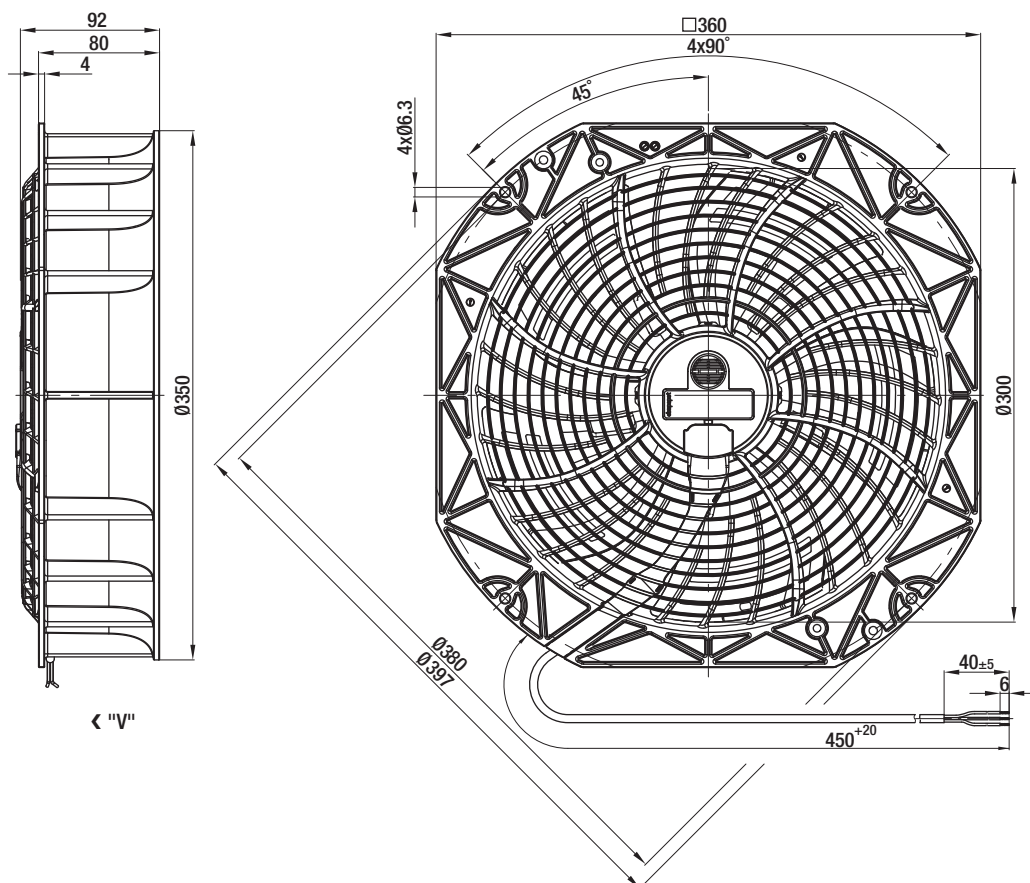
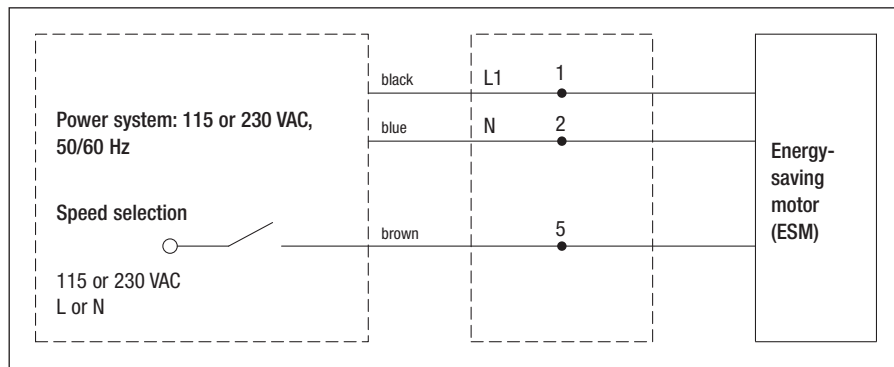

# Energy-saving axial fans

Ø 300

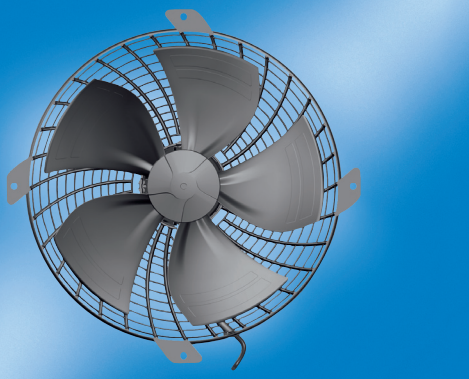

- **Material:** Blade: Plastic PA  
Guard grille: Plastic PP
- **Number of blades:** 5
- **Direction of air flow:** "A", intake over guard grille
- **Direction of rotation:** Counter-clockwise seen on rotor
- **Type of protection:** IP 54
- **Insulation class:** "B"
- **Mounting position:** Any
- **Condensate discharges:** None
- **Mode of operation:** Continuous operation (S1)
- **Bearings:** Maintenance-free ball bearings
- **Motor protection:** Via electronics and TOP
- **Electrical connection:** Line cord with plug
- **Protection class:** II
- **Product conforming to standard:** CE
- **Approvals:** VDE, UL, CSA is applied for
- **Speed:** Using the programming unit, 2 speeds between  $n_{min}$  and  $n_{max}$  can be programmed.

Nominal data		Curve	Nominal voltage	Frequency	Speed <sup>(1)</sup>	Max. Power input <sup>(1)</sup>	Max. Current draw <sup>(1)</sup>	Max. operative range	Perm. amb. temp.	Mass
Type	Motor	VAC	Hz	rpm	W	A	Pa	°C	kg	
<b>S1G 300-CA23 -02</b>	M1G 055-BI	A	115	50/60	1200	35	0,56	40	-30..+50	1,4
<b>S1G 300-CA19 -02</b>	M1G 055-BI	B	230	50/60	1200	35	0,28	40	-30..+50	1,4

subject to alterations

<sup>(1)</sup> Nominal data in operating point with maximum load and 115 or 230 VAC

## Curves

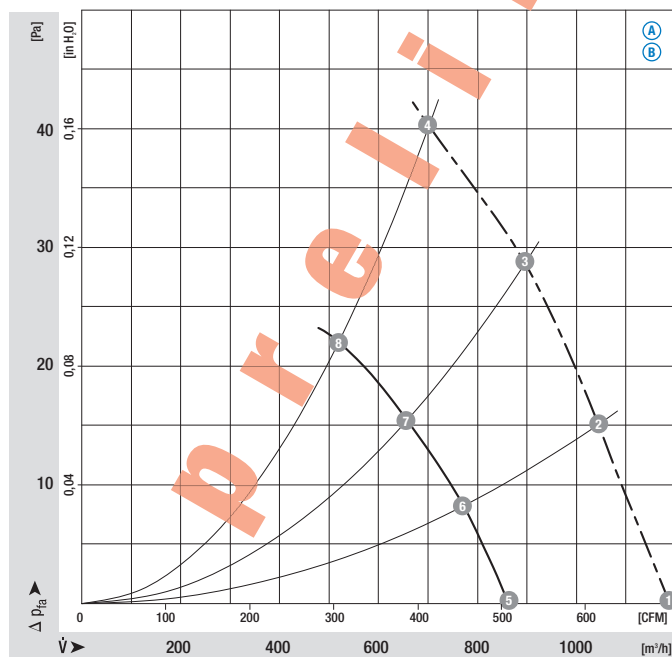

	n [rpm]	P <sub>1</sub> [W]	I [A]	Lp <sub>A</sub> [dB(A)]
A 1	1200	24	0,40	54
A 2	1200	27	0,44	53
A 3	1200	31	0,50	54
A 4	1200	35	0,56	54
A 5	900	16	0,30	51
A 6	900	18	0,34	50
A 7	900	19	0,36	49
A 8	900	21	0,40	49
B 1	1200	24	0,20	54
B 2	1200	27	0,22	53
B 3	1200	31	0,25	54
B 4	1200	35	0,28	54
B 5	900	16	0,15	51
B 6	900	18	0,17	50
B 7	900	19	0,18	49
B 8	900	21	0,20	49

– Electr.  
connection:

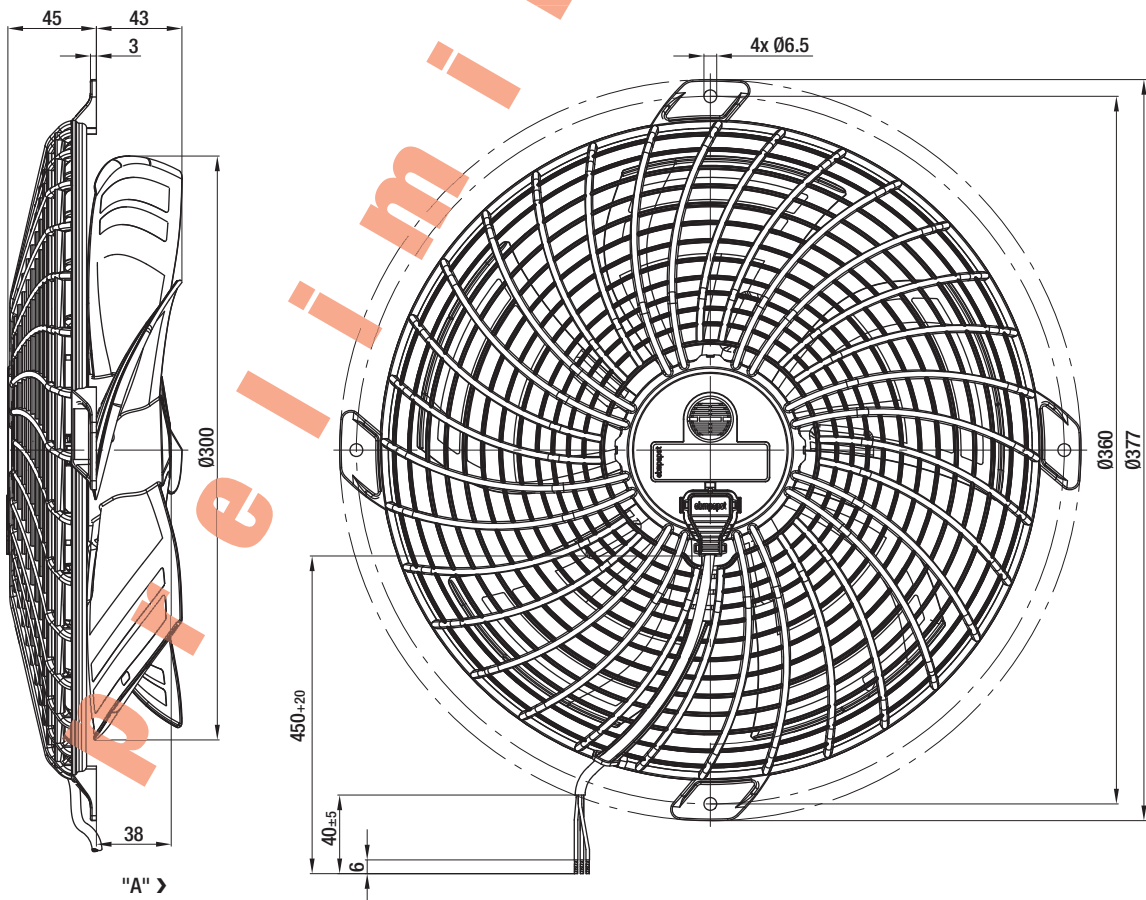
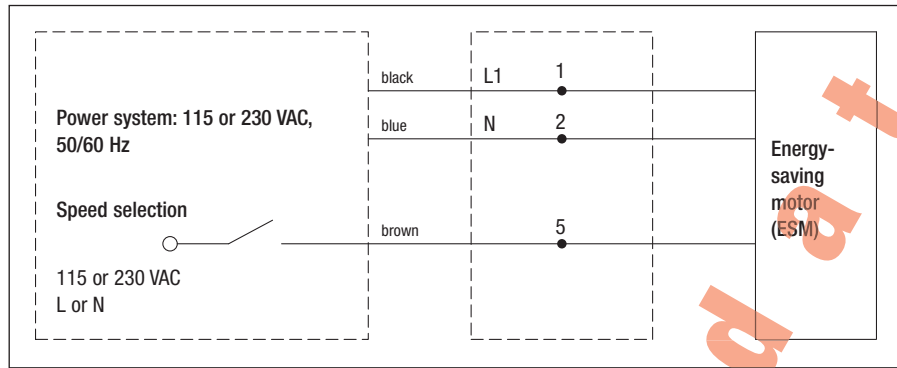

# Connection leads

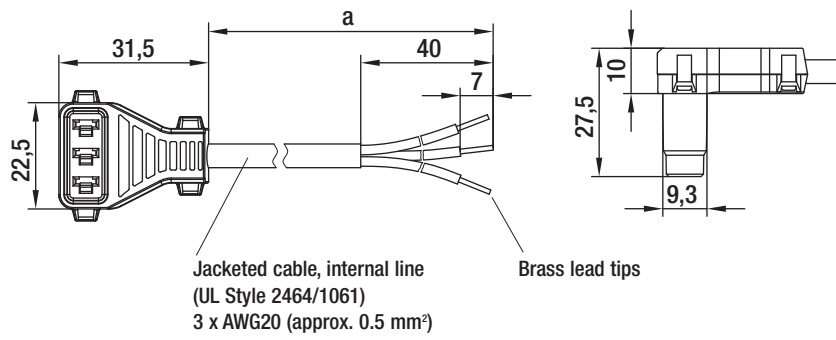





- **Design:** Cable conforms to UL standards, sealed plug

## Connection lines for energy-saving motors (ESM)

Part no.	a
10637-4-1040	450
10640-4-1040	600
10638-4-1040	1500
10639-4-1040	2000

subject to alterations



-  fan agent
-  compact fan agent
-  motor specialist
-  motor agent

# ebm-papst representatives & subsidiaries

## Germany

### ebm-papst Muldingen GmbH & Co. KG

Bachmühle 2  
D-74673 Muldingen  
Phone +49 (0) 79 38 / 81-0  
Fax +49 (0) 79 38 / 81-110  
info1@de.ebmpapst.com

www.ebmpapst.com

### ebm-papst St. Georgen GmbH & Co. KG

Hermann-Papst-Straße 1  
D-78112 St. Georgen  
Phone +49 (0) 77 24 / 81-0  
Fax +49 (0) 77 24 / 81-13 09  
info2@de.ebmpapst.com

www.ebmpapst.com





























### ebm-papst Landshut GmbH

Hofmark-Aich-Straße 25  
D-84030 Landshut  
Phone +49 (0) 8 71 / 707-0  
Fax +49 (0) 8 71 / 707-465  
info3@de.ebmpapst.com

www.ebmpapst.com

## Agencies

-  **Berlin**  
 Dipl.-Ing. (TH) Jens Duchow  
 Händelstraße 7  
 D-16341 Panketal  
Phone +49 (0) 30 / 94 41 49 62  
Fax +49 (0) 30 / 94 41 49 63  
Jens.Duchow@de.ebmpapst.com
-  **Bielefeld**  
 Dipl.-Ing. (FH) Wolf-Jürgen Weber  
 Niehausweg 13  
 D-33739 Bielefeld  
Phone +49 (0) 52 06 / 9 17 32 31  
Fax +49 (0) 52 06 / 9 17 32 35  
Wolf-Juergen.Weber@de.ebmpapst.com
-  **Dortmund**  
 Dipl.-Ing. (FH) Hans-Joachim Pundt  
 Auf den Steinern 3  
 D-59519 Möhnesee-Völlinghausen  
Phone +49 (0) 29 25 / 80 04 07  
Fax +49 (0) 29 25 / 80 04 08  
Hans-Joachim.Pundt@de.ebmpapst.com
-  **Frankfurt**  
 Dipl.-Ing. Christian Kleffmann  
 Dr.-Hermann-Krause-Straße 23  
 D-63452 Hanau  
Phone +49 (0) 61 81 / 18 98 12  
Fax +49 (0) 61 81 / 18 98 13  
Christian.Kleffmann@de.ebmpapst.com
-  **Halle**  
 Dipl.-Ing. (TU) Michael Hanning  
 Lerchenweg 4  
 D-06120 Lieskau  
Phone +49 (0) 3 45 / 5 51 24 56  
Fax +49 (0) 3 45 / 5 51 24 57  
Michael.Hanning@de.ebmpapst.com
-  **Hamburg**  
 Ingenieurbüro Breuell GmbH  
 Ing. Dirk Kahl  
 Elektroingenieur  
Grützmühlenweg 40  
D-22339 Hamburg  
Phone +49 (0) 40 / 53 80 92 55  
Fax +49 (0) 40 / 53 80 92 84  
Dirk.Kahl@de.ebmpapst.com

-  **Kassel**  
 Dipl.-Ing. (FH) Ralph Brück  
 Hoherainstraße 38  
 D-35075 Gladenbach  
Phone +49 (0) 64 62 / 40 71 10  
Fax +49 (0) 64 62 / 40 71 11  
Ralph.Brueck@de.ebmpapst.com
-  **Koblenz**  
 Winfried Schaefer  
 Hinter der Kirch 10  
 D-56767 Uersfeld  
Phone +49 (0) 26 57 / 16 96  
Fax +49 (0) 26 57 / 16 76  
Winfried.Schaefer@de.ebmpapst.com
-  **Munich**  
 Dipl.-Wirtsch.-Ing. (FH) Jens Peter  
 Steinbergweg 6  
 D-82285 Hattenhofen  
Phone +49 (0) 81 45 / 80 92 25  
Fax +49 (0) 81 45 / 80 92 26  
Jens.Peter@de.ebmpapst.com
-  **Nuremberg**  
 Friedrich Klein  
 Adlerstraße 49/1  
 D-73540 Heubach  
Phone +49 (0) 71 73 / 49 83  
Fax +49 (0) 71 73 / 80 53  
Friedrich.Klein@de.ebmpapst.com
-  **Offenburg**  
 Dipl.-Ing. (FH) Ralf Braun  
 Hubeneck 21  
 D-77704 Oberkirch  
Phone +49 (0) 78 02 / 98 22 52  
Fax +49 (0) 78 02 / 98 22 53  
Ralf.Braun@de.ebmpapst.com
-  **Stuttgart**  
 Dipl.-Ing. (FH) Rudi Weinmann  
 Hindenburgstraße 100/1  
 D-73207 Plochingen  
Phone +49 (0) 71 53 / 92 89 80  
Fax +49 (0) 71 53 / 92 89 81  
Rudi.Weinmann@de.ebmpapst.com
-  **Ulm**  
 Günter Wilhelm  
 Allgäuer Straße 7  
 D-89269 Vöhringen  
Phone +49 (0) 73 06 / 92 46 08  
Fax +49 (0) 73 06 / 92 46 48  
Gunter.Wilhelm@de.ebmpapst.com

## Distributors

-  **Frankfurt**  
 R.E.D. Handelsgesellschaft mbH  
 Gutenbergstraße 3  
 D-63110 Rodgau - Jügesheim  
Phone +49 (0) 61 06 / 84 10  
Fax +49 (0) 61 06 / 84 11 11  
info@red-elektromechanik.de  
www.red-elektromechanik.de
-  **Hamburg**  
 Breuell + Hilgenfeldt GmbH  
 Grützmühlenweg 40  
 D-22339 Hamburg  
Phone +49 (0) 40 / 53 80 92 20  
Fax +49 (0) 40 / 53 80 92 84  
info@breuell-hilgenfeldt.de
-  **Munich**  
 A. Schweiger GmbH  
 Ohmstraße 1  
 D-82054 Sauerlach  
Phone +49 (0) 81 04 / 8 97 0  
Fax +49 (0) 81 04 / 8 97 90  
info@schweiger-gmbh.de  
www.schweiger-gmbh.com
- **Express Service-Center** (1 to 5 pieces)
-  **North**  
 Breuell + Hilgenfeldt GmbH  
 Grützmühlenweg 40  
 D-22339 Hamburg  
Phone +49 (0) 40 / 53 80 92 20  
Fax +49 (0) 40 / 53 80 92 84  
ebmpapst@breuell-hilgenfeldt.de
-  **South**  
 HDS Ventilatoren Vertriebs GmbH  
 Glaswiesenstraße 1  
 D-74677 Dörzbach  
Phone +49 (0) 79 37 / 80 29 68  
Fax +49 (0) 79 37 / 80 25 78  
info@hds-gmbh.net

## Europe

 **Austria**  
 ebm-papst Motoren & Ventilatoren GmbH  
 Westbahnstraße 5  
A-4490 St. Florian  
Phone +43 / 72 24 / 66 01 10  
Fax +43 / 72 24 / 66 01 120  
info@at.ebmpapst.com  
www.ebmpapst.at

 **Belarus**  
 ebm-papst Bel AgmbH  
 Prospekt Nesavisimosti 11/2 office 325, 512  
BY-220050 Minsk  
Phone +375 / 17 / 209 95 61  
Fax +375 / 17 / 209 95 61  
info@by.ebmpapst.com  
www.ebmpapst.by

 **Belgium**  
 VIBO Benelux B. V.  
 Sales office Belgium-Luxemburg  
Romeinsestraat 6/0101  
Research Park Haasrode  
B-3001 Heverlee-Leuven  
Phone +32 / 16 / 39 62 00  
Fax +32 / 16 / 39 62 20  
info@vibobenelux.com  
www.vibobenelux.com

 **Bulgaria**  
 ebm-papst Romania S.R.L.  
 Str. Tirnavei Nr. 20  
RO-500327 Brasov  
Phone +40 / 268 / 312 805  
Fax +40 / 268 / 312 805  
dudasludovic@xnet.ro

 **Croatia**  
 ebm-papst Industries Kft.  
 Ezred u. 2.  
H-1044 Budapest  
Phone +36 / 1 / 87 22 190  
Fax +36 / 1 / 87 22 194  
office@hu.ebmpapst.com  
www.ebmpapst.hu



 **Cyprus**  
 MATERO LTD  
 37, St. Kyriakides Avenue  
P.O. Box 51744  
CY-3080 Limassol  
Phone +357 / 25 / 87 00 30  
Fax +357 / 25 / 38 13 66  
matero@cytanet.com.cy  
www.matero.com.cy

 **Czech Republic / Slovakia**  
 ebm-papst CZ s.r.o.  
 Krátká 379  
CZ-66461 Rajhradice u Brna  
Phone +420 / 547 / 232 617  
Fax +420 / 547 / 232 622  
info@ebmpapst.cz  
www.ebmpapst.cz

 **Denmark**  
 Jenk A/S  
 Vallensbækvej 21  
DK-2605 Brøndby  
Phone +45 / 43 / 63 11 11  
Fax +45 / 43 / 63 05 05  
jenk@jenk.dk  
www.jenk.dk

 **Estonia**  
 ebm-papst Oy Eesti Filiaal  
 Kadaka tee 3  
EST-10621 Tallinn  
Phone +372 / 65 56 / 978  
Fax +372 / 65 56 / 979  
www.ebmpapst.ee

 **Finland**  
 ebm-papst Oy  
 Puistotie 1  
FIN-02760 Espoo  
Phone +358 / 9 / 88 70 22 0  
Fax +358 / 9 / 88 70 22 13  
mailbox@ebmpapst.fi  
www.ebmpapst.fi

 **France**  
 ebm-papst SARL  
 ZI Nord - rue A. Mohler  
BP 62  
F-67212 Obernai-Cedex  
Phone +33 / 820 326 266  
Fax +33 / 3 / 88 67 38 83  
info@ebmpapst.fr  
www.ebmpapst.fr

 **Greece**  
 Helcoma  
 Th. Rotas & Co OE  
Davaki 65  
GR-17672 Kallithea-Attiki  
Phone +30 / 210 / 951 37 05  
Fax +30 / 210 / 951 34 90  
contact@helcoma.gr  
www.helcoma.gr





 **Hungary**  
 ebm-papst Industries Kft.  
 Ezred u. 2.  
H-1044 Budapest  
Phone +36 / 1 / 87 22 190  
Fax +36 / 1 / 87 22 194  
office@hu.ebmpapst.com  
www.ebmpapst.hu

 **Iceland**  
 RJ Engineers  
 Stangarhyl 1A  
IS-110 Reykjavik  
Phone +354 / 567 80 30  
Fax +354 / 567 80 15  
rj@rj.is  
www.rj.is

 **Ireland**  
 ebm-papst Limited  
 Portlaoise Business & Technology Park  
Mountrath Road  
IRL-Portlaoise, Co. Laois  
Phone +353 / 57 86 / 643 43  
Fax +353 / 57 86 / 643 46  
sales@ie.ebmpapst.com  
www.ebmpapst.ie





 **Italy**  
 ebm-papst Srl  
 Via Cornaggia 108  
I-22076 Mozzate (Co)  
Phone +39 / 03 31 / 83 62 01  
Fax +39 / 03 31 / 82 15 10  
info@it.ebmpapst.com  
www.ebmpapst.it

 **Macedonia**  
 ebm-papst Industries Kft.  
 Ezred u. 2.  
H-1044 Budapest  
Phone +36 / 1 / 87 22 190  
Fax +36 / 1 / 87 22 194  
office@hu.ebmpapst.com  
www.ebmpapst.hu

-  fan agent
-  compact fan agent
-  motor specialist
-  motor agent

# ebm-papst representatives & subsidiaries



 **Netherlands**  
 VIBO Benelux B. V.  
 Engelseweg 127  
 Postbus 230  
 NL-5705 AC Helmond  
 Phone +31 / 4 92 / 50 29 00  
 Fax +31 / 4 92 / 50 29 50  
[verkoop@vibobnelux.com](mailto:verkoop@vibobnelux.com)  
[www.vibobnelux.com](http://www.vibobnelux.com)

 **Norway**  
 ebm-papst AS  
 P.B. 173 Holmlia  
 N-1203 Oslo  
 Phone +47 / 22 / 76 33 40  
 Fax +47 / 22 / 61 91 73  
[mailbox@ebmpapst.no](mailto:mailbox@ebmpapst.no)  
[www.ebmpapst.no](http://www.ebmpapst.no)





 **Poland**  
 ebm-papst Polska Sp. z o.o.  
 ul. Annapol 4A  
 PL-03236 Warszawa  
 Phone +48 / 22 / 675 78 19  
 Fax +48 / 22 / 676 95 87  
[office@ebmpapst.pl](mailto:office@ebmpapst.pl)  
[www.ebmpapst.pl](http://www.ebmpapst.pl)

 **Portugal**  
 ebm-papst (Portugal), Lda.  
 Av. Marechal Gomes da Costa, 35 e  
 Rua Conselheiro Emidio Navarro  
 P-1800-255 Lisboa  
 Phone +351 / 218 / 394 880  
 Fax +351 / 218 / 394 759  
[info@pt.ebmpapst.com](mailto:info@pt.ebmpapst.com)  
[www.ebmpapst.pt](http://www.ebmpapst.pt)

 **Romania**  
 ebm-papst Romania S.R.L.  
 Str. Tirnavei Nr. 20  
 RO-500327 Brasov  
 Phone +40 / 268 / 312 805  
 Fax +40 / 268 / 312 805  
[dudasludovic@xnet.ro](mailto:dudasludovic@xnet.ro)

 **Russia**  
 ebm-papst Ural GmbH  
 Posadskaja-Strasse, 23(E), 3  
 RU-620102 Ekaterinburg  
 Phone +7 / 343 / 233 80 00  
 Fax +7 / 343 / 233 77 88  
[Konstantin.Molokov@ru.ebmpapst.com](mailto:Konstantin.Molokov@ru.ebmpapst.com)  
[www.ebmpapst.ur.ru](http://www.ebmpapst.ur.ru)

 ebm-papst Rus GmbH  
 Nizhegorodskaya 32, str. 15 office 420  
 RU-109029 Moskau  
 Phone +7 / 495 / 671 53 93  
 Fax +7 / 495 / 671 53 95  
[info@ebmpapst.ru](mailto:info@ebmpapst.ru)  
[www.ebmpapst.ru](http://www.ebmpapst.ru)

 ebm-papst Rus  
 Saint-Petersburg's Filial  
 Zastavskaya 7  
 RU-196084 Sankt-Petersburg  
 Phone +7 / 812 / 449 96 07  
 Fax +7 / 812 / 449 96 07  
[spb@ru.ebmpapst.com](mailto:spb@ru.ebmpapst.com)

 **Serbia & Montenegro**  
 ebm-papst Industries Kft.  
 Ezred u. 2.  
 H-1044 Budapest  
 Phone +36 / 1 / 87 22 190  
 Fax +36 / 1 / 87 22 194  
[office@hu.ebmpapst.com](mailto:office@hu.ebmpapst.com)  
[www.ebmpapst.hu](http://www.ebmpapst.hu)

 **Spain**  
 ebm-papst Ibérica S.L.  
 Avda. del Sistema Solar, 29  
 E-28830 San Fernando de Henares (Madrid)  
 Phone +34 / 91 / 678 08 94  
 Fax +34 / 91 / 678 15 30  
[ventas@ebmpapst.es](mailto:ventas@ebmpapst.es)

 **Sweden**  
 ebm-papst AB  
 Äggelundavägen 2  
 S-17562 Järfälla  
 Phone +46 / 8 / 761 94 00  
 Fax +46 / 8 / 36 23 06  
[info@ebmpapst.se](mailto:info@ebmpapst.se)  
[www.ebmpapst.se](http://www.ebmpapst.se)

 **Switzerland**  
 ebm-papst AG  
 Rütisbergstrasse 1  
 CH-8156 Oberhasli  
 Phone +41 / 44 / 732 20 70  
 Fax +41 / 44 / 732 20 77  
[verkauf@ebmpapst.ch](mailto:verkauf@ebmpapst.ch)  
[www.ebmpapst.ch](http://www.ebmpapst.ch)

 **Turkey**  
 Akantel Elektronik San. Tic. LTD. Sti.  
 Atatürk Organize Sanayi  
 Bölgesi 10007 SK. No.:6  
 TR-35620 Cigli-Izmir  
 Phone +90 / 232 / 328 20 90  
 Fax +90 / 232 / 328 02 70  
[akantel@akantel.com.tr](mailto:akantel@akantel.com.tr)  
[www.ebmpapst.com.tr](http://www.ebmpapst.com.tr)

 **Ukraine**  
 ebm-papst Ukraine LLC  
 Lepse Boulevard, 4, Building 47  
 UA-03067 Kiev  
 Phone +38 / 044 / 206 30 91  
 Fax +38 / 044 / 206 30 91  
[mail@ebmpapst.ua](mailto:mail@ebmpapst.ua)  
[www.ebmpapst.ua](http://www.ebmpapst.ua)

 **United Kingdom**  
 ebm-papst UK Ltd.  
 Chelmsford Business Park  
 GB-Chelmsford Essex CM2 5EZ  
 Phone +44 / 12 45 / 46 85 55  
 Fax +44 / 12 45 / 46 63 36  
[sales@uk.ebmpapst.com](mailto:sales@uk.ebmpapst.com)  
[www.ebmpapst.co.uk](http://www.ebmpapst.co.uk)

 ebm-papst Automotive & Drives (UK) Ltd.  
 The Smithy  
 Fidlers Lane, East Ilsley  
 GB-Berkshire RG20 7LG  
 Phone +44 / 87 07 / 66 51 70  
 Fax +44 / 87 07 / 66 51 80  
[A&Dsales@uk.ebmpapst.com](mailto:A&Dsales@uk.ebmpapst.com)  
[www.ebmpapst-ad.com](http://www.ebmpapst-ad.com)



## America

---



### Argentina



ebm-papst de Argentina S.A.  
Hernandarias 148 Lomas del Mirador  
Pcia. de Buenos Aires (1752)  
Phone +54 / 11 46 57 61 35  
Fax +54 / 11 46 57 20 92  
ventas@ar.ebmpapst.com  
www.ebmpapst.com.ar



### Brasil



ebm-papst Motores Ventiladores Ltda.  
Av. José Giorgi, 301 Galpões B6+B7  
Condominio Logical Center  
BR-06707-100 Cotia - São Paulo  
Phone +55 / 11 / 31 64 89 00  
Fax +55 / 11 / 47 77 14 56  
vendas@br.ebmpapst.com  
www.ebmpapst.com.br



### Canada



ebm-papst Canada Inc.  
1800 Ironstone Manor, Unit 2  
CDN-Pickering, Ontario, L1W3J9  
Phone +1 / 905 / 420 / 35 33  
Fax +1 / 905 / 420 / 37 72  
sales@ca.ebmpapst.com  
www.ebmpapst.ca



### Mexico



ebm Industrial S.de R.L. de C.V.  
Paseo de Tamarindos 400-A-5º Piso  
Col. Bosques de las Lomas  
MEX-Mexico 05120, D.F.  
Phone +52 / 55 / 33 00 51 44  
Fax +52 / 55 / 33 00 52 43  
sales@mx.ebmpapst.com  
www.ebmpapst.com.mx

## USA



ebm-papst Inc.



P.O. Box 4009  
100 Hyde Road  
USA-Farmington, CT 06034  
Phone +1 / 860 / 674 15 15  
Fax +1 / 860 / 674 85 36  
sales@us.ebmpapst.com  
www.ebmpapst.us



ebm-papst Automotive & Drives, Inc.



3200 Greenfield, Suite 255  
USA-Dearborn, MI 48120  
Phone +1 / 313 / 406 80 80  
Fax +1 / 313 / 406 80 81  
automotive@us.ebmpapst.com  
www.ebmpapst-automotive.us

## Africa





---



### South Africa



ebm-papst South Africa (Pty) Ltd.  
P.O. Box 3124  
1119 Yacht Avenue  
ZA-2040 Honeydew  
Phone +27 / 11 / 794 34 34  
Fax +27 / 11 / 794 50 20  
info@za.ebmpapst.com  
www.ebmpapst.co.za

-  fan agent
-  compact fan agent
-  motor specialist
-  motor agent

# ebm-papst representatives & subsidiaries

## Asia

 **China**  
 ebm-papst Ventilator (Shanghai) Co., Ltd.  
 No. 418, Huajing Road  
 WaiGaoQiao Free Trade Zone  
 No. 2001, Yang Gao (N) Road  
 VRC-200131 Shanghai, P.R. of China  
 Phone +86 / 21 / 50 46 01 83  
 Fax +86 / 21 / 50 46 11 19  
 sales@cn.ebmpapst.com  
 www.ebmpapst.com.cn

 **Hong Kong**  
 ebm-papst Ventilator (Shanghai) Co., Ltd.  
 Hong Kong Representative Office  
 Unit Nos. 13-15, 9/F, Technology Park  
 18 On Lai Street, Siu Lek Yuen, Shatin,  
 N.T. Hong Kong P.R. of China  
 Phone +852 / 21 45 / 86 78  
 Fax +852 / 21 45 / 76 78  
 info@hk.ebmpapst.com

 **India**  
 ebm NADI International Pvt Ltd.  
 26/3, G.N.T. Road, Erukkencherry  
 IND-Chennai-600118  
 Phone +91 / 44 / 25 37 25 56  
 Fax +91 / 44 / 25 37 11 49  
 ebmnadi@md2.vsnl.net.in  
 www.ebmnadi.com

 **Indonesia**  
 ebm-papst Indonesia  
 Wisma Slipi, Jl. Letjend S. Parman Kav. 12  
 14th Floor, No. 1410  
 RI-11480 Jakarta Barat  
 Phone +62 / 21 / 53 66 19 01  
 Fax +62 / 21 / 53 66 19 05  
 salesdept@id.ebmpapst.com

 **Israel**  
 Polak Bros. Import Agencies Ltd.  
 9 Hamefalsim Street  
 IL-Kiryat Arie, Petach-Tikva 49514  
 Phone +972 / 3 / 910 03 00  
 Fax +972 / 3 / 579 66 79  
 polak@polak.co.il  
 www.polak.co.il

 **Japan**  
 ebm-papst Industries Japan K.K.  
 12 Floor, Benex S-3 Bldg.  
 3-20-8 Shinyokohama, Kohoku-ku  
 J-222-0033 Yokohama  
 Phone +81 / 45 / 470 / 57 51  
 Fax +81 / 45 / 470 / 57 52  
 info@jp.ebmpapst.com  
 www.ebmpapst.jp

 **Korea**  
 ebm-papst Korea Co. Ltd.  
 6F, Trutech Bldg.  
 B 6-2, Digital Media City (DMC)  
 Sangam-Dong, Mapo-Gu  
 ROK-Seoul 121-270  
 Phone +82 / 2 / 36 62 / 13 24  
 Fax +82 / 2 / 36 62 / 13 26  
 info@kr.ebmpapst.com  
 www.ebmpapst.co.kr

 **Malaysia**  
 ebm-papst Malaysia  
 Representative Office  
 Block F1, 9A-4, Jln PJU 1/42  
 Dataran Prima  
 MAL-47301 Petaling Jaya  
 Phone +60 / 3 / 78 06 54 40  
 Fax +60 / 3 / 78 06 54 41  
 salesdept@my.ebmpapst.com

 **Singapore**  
 ebm-papst SEA Pte. Ltd.  
 No. 23 Ubi Road 4  
 #06-00 Olympia Industrial Building  
 SGP-Singapore 408620  
 Phone +65 / 65 51 37 89  
 Fax +65 / 68 42 84 39  
 salesdept@sg.ebmpapst.com

 **Taiwan**  
 ETECO Engineering & Trading Corp.  
 10F-I, No. 92, Teh-Wei Str.  
 RC-Tsow-Inn District, Kaohsiung  
 Phone +886 / 7 / 557 42 68  
 Fax +886 / 7 / 557 27 88  
 eteco@ms22.hinet.net

 **Thailand**  
 ebm-papst Thailand Co., Ltd.  
 99/349 Na-Nakorn Bldg., 4th Floor  
 Chaeng Wattana Road, Thungsonghong,  
 THA-10210 Laksi, BKK  
 Phone +66 / 2 / 5 76 15 24  
 Fax +66 / 2 / 5 76 15 42  
 salesdept@th.ebmpapst.com

 **United Arab Emirates**  
 ebm-papst Middle East FZE  
 PO Box 17755  
 Jebel Ali Free Zone / FZS1 / AP05  
 UAE-Dubai  
 Phone +971 / 4 / 886 08 26  
 Fax +971 / 4 / 886 08 27  
 info@ae.ebmpapst.com  
 www.ebmpapst.ae

## Australia

---



### Australia

ebm-papst A&NZ Pty Ltd.



10 Oxford Road



AUS-Laverton North, Victoria, 3026

Phone +61 / 3 / 83 25 64 00

Fax +61 / 3 / 83 25 64 64

[sales@ebmpapst.com.au](mailto:sales@ebmpapst.com.au)

[www.ebmpapst.com.au](http://www.ebmpapst.com.au)



### New Zealand

ebm-papst A&NZ Pty Ltd.



102 Henderson Valley Road



NZ-Henderson, Auckland 1230

Phone +64 / 9 / 837 18 84

Fax +64 / 9 / 837 18 99

[sales@ebmpapst.com.au](mailto:sales@ebmpapst.com.au)

[www.ebmpapst.com.au](http://www.ebmpapst.com.au)

Printed in Germany

**ebm-papst**  
**Mulfingen GmbH & Co. KG**

Bachmühle 2  
D-74673 Mulfingen  
Phone +49 (0) 79 38 / 81-0  
Fax +49 (0) 79 38 / 81-110  
info1@de.ebmpapst.com

[www.ebmpapst.com](http://www.ebmpapst.com)

**ebmpapst**

Компания «Life Electronics» занимается поставками электронных компонентов импортного и отечественного производства от производителей и со складов крупных дистрибьюторов Европы, Америки и Азии.

С конца 2013 года компания активно расширяет линейку поставок компонентов по направлению коаксиальный кабель, кварцевые генераторы и конденсаторы (керамические, пленочные, электролитические), за счёт заключения дистрибьюторских договоров

Мы предлагаем:

- Конкурентоспособные цены и скидки постоянным клиентам.
- Специальные условия для постоянных клиентов.
- Подбор аналогов.
- Поставку компонентов в любых объемах, удовлетворяющих вашим потребностям.
- Приемлемые сроки поставки, возможна ускоренная поставка.
- Доставку товара в любую точку России и стран СНГ.
- Комплексную поставку.
- Работу по проектам и поставку образцов.
- Формирование склада под заказчика.
- Сертификаты соответствия на поставляемую продукцию (по желанию клиента).
- Тестирование поставляемой продукции.
- Поставку компонентов, требующих военную и космическую приемку.
- Входной контроль качества.
- Наличие сертификата ISO.

В составе нашей компании организован Конструкторский отдел, призванный помогать разработчикам, и инженерам.

Конструкторский отдел помогает осуществить:

- Регистрацию проекта у производителя компонентов.
- Техническую поддержку проекта.
- Защиту от снятия компонента с производства.
- Оценку стоимости проекта по компонентам.
- Изготовление тестовой платы монтаж и пусконаладочные работы.



Тел: +7 (812) 336 43 04 (многоканальный)

Email: [org@lifeelectronics.ru](mailto:org@lifeelectronics.ru)