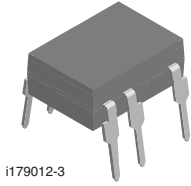
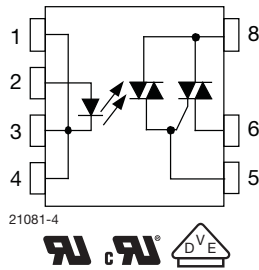


## Optocoupler, Power Phototriac



i179012-3



### FEATURES

- Fully integrated power TRIAC
- Maximum trigger current ( $I_{FT}$ ): 10 mA
- Isolation test voltage 5300  $V_{RMS}$
- Peak off-state voltage 600 V
- Load current 1  $A_{RMS}$
- $dV/dt$  of 600  $V/\mu s$
- DIP-8 package
- Pure tin leads
- Material categorization: for definitions of compliance please see [www.vishay.com/doc?99912](http://www.vishay.com/doc?99912)



**RoHS**  
COMPLIANT

### DESCRIPTION

The VO2223B is an optically coupled phototriac driving an integrated power TRIAC in a DIP-8 package. Featuring galvanic and electrical noise isolation, the VO2223B is able to directly drive medium AC loads with a low voltage input signal. The high blocking voltage of 600 V permits control of off-line voltages up to 230  $V_{AC}$  and is sufficient for as much as 380  $V_{AC}$ .

### APPLICATIONS

- Air conditioners
- Microwave ovens
- Washing machines
- Refrigerators
- Fan heaters
- Inductive heating cooker
- Water heaters
- Industrial equipments

### AGENCY APPROVALS

- UL
- cUL
- DIN EN 60747-5-5 (VDE 0884-5), available with option 1

ORDERING INFORMATION	
<div style="display: flex; justify-content: space-around; align-items: center;"> <div style="border: 1px solid black; padding: 2px; margin: 2px;">V</div> <div style="border: 1px solid black; padding: 2px; margin: 2px;">O</div> <div style="border: 1px solid black; padding: 2px; margin: 2px;">2</div> <div style="border: 1px solid black; padding: 2px; margin: 2px;">2</div> <div style="border: 1px solid black; padding: 2px; margin: 2px;">2</div> <div style="border: 1px solid black; padding: 2px; margin: 2px;">3</div> <div style="border: 1px solid black; padding: 2px; margin: 2px;">B</div> <div style="border: 1px solid black; padding: 2px; margin: 2px;">-</div> <div style="border: 1px solid black; padding: 2px; margin: 2px;">X</div> <div style="border: 1px solid black; padding: 2px; margin: 2px;">0</div> <div style="border: 1px solid black; padding: 2px; margin: 2px;">0</div> <div style="border: 1px solid black; padding: 2px; margin: 2px;">#</div> </div> <p style="text-align: center;">PART NUMBER</p>	<div style="display: flex; justify-content: space-around; align-items: center;"> <div style="border: 1px solid black; padding: 2px; margin: 2px;">X</div> <div style="border: 1px solid black; padding: 2px; margin: 2px;">0</div> <div style="border: 1px solid black; padding: 2px; margin: 2px;">0</div> <div style="border: 1px solid black; padding: 2px; margin: 2px;">#</div> </div> <p style="text-align: center;">PACKAGE OPTION</p> <div style="display: flex; justify-content: space-around; align-items: center; margin-top: 10px;"> <div style="text-align: center;"> <p>DIP-8 7.62 mm</p> </div> <div style="text-align: center;"> <p>Option 7 &gt; 0.7 mm</p> </div> </div>
AGENCY CERTIFIED/PACKAGE	TRIGGER, CURRENT $I_{FT}$ (mA)
UL, cUL	10
DIP-8	VO2223B
SMD-8, option 7	VO2223B-X007T
VDE, UL, cUL	10
DIP-8	VO2223B-X001
SMD-8, option 7	VO2223B-X017T

<b>ABSOLUTE MAXIMUM RATINGS</b> ( $T_{amb} = 25\text{ }^{\circ}\text{C}$ , unless otherwise specified)				
PARAMETER	TEST CONDITION	SYMBOL	VALUE	UNIT
<b>INPUT</b>				
Forward current		$I_F$	50	mA
Reverse voltage		$V_R$	5	V
Input power dissipation		$P_{diss}$	70	mW
<b>OUTPUT</b>				
Repetitive peak off-state voltage	Sine wave, 50 Hz to 60 Hz, gate open	$V_{DRM}$	600	V
RMS on-state current		$I_{T(RMS)}$	1	A
Non repetitive surge peak on-state current	50 Hz, peak	$I_{TSM}$	10	A
<b>COUPLER</b>				
Total power dissipation <sup>(1)</sup>		$P_{diss}$	1.2	W
Ambient temperature range		$T_{amb}$	-40 to +85	$^{\circ}\text{C}$
Storage temperature range		$T_{stg}$	-40 to +125	$^{\circ}\text{C}$
Soldering temperature	$t \leq 10\text{ s max.}$	$T_{sld}$	260	$^{\circ}\text{C}$

**Notes**

- Stresses in excess of the absolute maximum ratings can cause permanent damage to the device. Functional operation of the device is not implied at these or any other conditions in excess of those given in the operational sections of this document. Exposure to absolute maximum ratings for extended periods of the time can adversely affect reliability
- <sup>(1)</sup> Total power dissipation value is based on 2S2P PCB

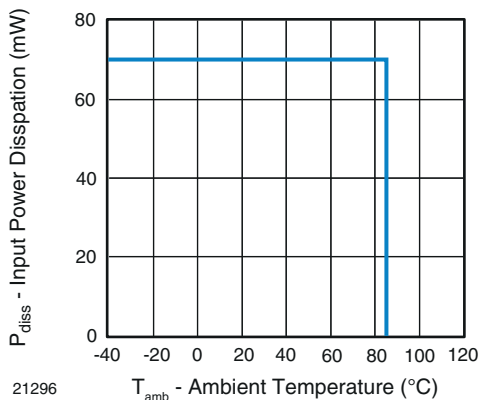
**ABSOLUTE MAXIMUM RATING CURVES**


Fig. 1 - Input Power Dissipation vs. Ambient Temperature

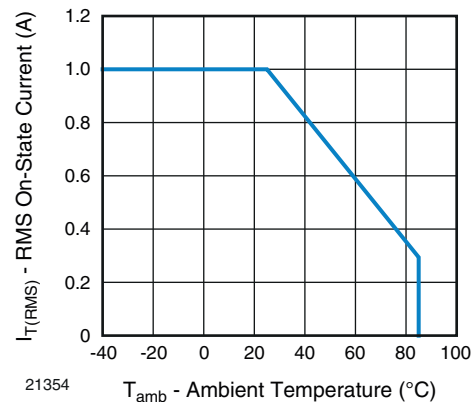


Fig. 2 - RMS On-State Current vs. Ambient Temperature

**Note**

- The RMS on-state current was calculated out under a given operating conditions and only for reference: input power:  $Q_E = 0.015\text{ W}$ ,  $\theta_{BA}$  (4-layer) =  $30\text{ }^{\circ}\text{C/W}$

<b>ELECTRICAL CHARACTERISTICS</b> ( $T_{amb} = 25\text{ }^{\circ}\text{C}$ , unless otherwise specified)						
PARAMETER	TEST CONDITION	SYMBOL	MIN.	TYP.	MAX.	UNIT
<b>INPUT</b>						
Trigger input current	$V_T = 6\text{ V}$	$I_{FT}$	2.5	-	10	mA
Input reverse current	$V_R = 5\text{ V}$	$I_R$	-	-	10	$\mu\text{A}$
Forward voltage	$I_F = 10\text{ mA}$	$V_F$	0.9	-	1.4	V
<b>OUTPUT</b>						
Peak on-state voltage	$I_{TM} = 1\text{ A}$	$V_{TM}$	-	-	1.7	V
Peak off-state current	$V_{DRM} = 600\text{ V}$	$I_{DRM}$	-	-	100	$\mu\text{A}$
Holding current	$R_L = 100\ \Omega$	$I_H$	-	-	25	mA
Critical rate of rise of off-state voltage	$V_{IN} = 400\text{ V}_{RMS}$ (Fig. 3)	$dV/dt_{cr}$	-	600	-	$\text{V}/\mu\text{s}$
Critical rate of rise of commutating voltage	$V_{IN} = 240\text{ V}_{RMS}$ , $I_T = 1\text{ A}_{RMS}$ (Fig. 3)	$dV/dt_{crq}$	-	0.7	-	$\text{V}/\mu\text{s}$

**Note**

- Minimum and maximum values are testing requirements. Typical values are characteristics of the device and are the result of engineering evaluations. Typical values are for information only and are not part of the testing requirements



Fig. 3 - dV/dt Test Circuit

<b>SAFETY AND INSULATION RATINGS</b>				
PARAMETER	TEST CONDITION	SYMBOL	VALUE	UNIT
Climatic classification	According to IEC 68 part 1		40 / 85 / 21	
Pollution degree	According to DIN VDE 0109		2	
Comparative tracking index	Insulation group IIIa	CTI	175	
Maximum rated withstanding isolation voltage	According to UL1577, $t = 1\text{ min}$	$V_{ISO}$	4470	$V_{RMS}$
Tested withstanding isolation voltage	According to UL1577, $t = 1\text{ s}$	$V_{ISO}$	5300	$V_{RMS}$
Maximum transient isolation voltage	According to DIN EN 60747-5-5	$V_{IOTM}$	8000	$V_{peak}$
Maximum repetitive peak isolation voltage	According to DIN EN 60747-5-5	$V_{IORM}$	890	$V_{peak}$
Isolation resistance	$T_{amb} = 25\text{ }^{\circ}\text{C}$ , $V_{IO} = 500\text{ V}$	$R_{IO}$	$\geq 10^{12}$	$\Omega$
	$T_{amb} = 100\text{ }^{\circ}\text{C}$ , $V_{IO} = 500\text{ V}$	$R_{IO}$	$\geq 10^{11}$	$\Omega$
Output safety power		$P_{SO}$	2000	mW
Input safety current		$I_{SI}$	150	mA
Input safety temperature		$T_{SI}$	165	$^{\circ}\text{C}$
Creepage distance	DIP-8		$\geq 7$	mm
Clearance distance			$\geq 7$	mm
Creepage distance	SMD-8, option 7		$\geq 8$	mm
Clearance distance			$\geq 8$	mm
Insulation thickness		DTI	$\geq 0.4$	mm

**Note**

- This phototriac coupler is suitable for "safe electrical insulation" only within the safety ratings. Compliance with safety ratings shall be ensured by means of protective circuits

**TYPICAL CHARACTERISTICS** ( $T_{amb} = 25\text{ }^{\circ}\text{C}$ , unless otherwise specified)

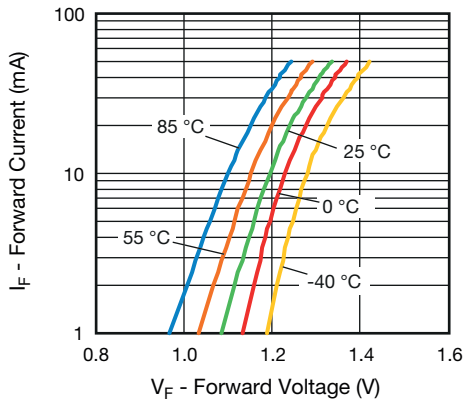


Fig. 4 - Forward Current vs. Forward Voltage



Fig. 7 - Off-State Leakage Current vs. Off-State Voltage

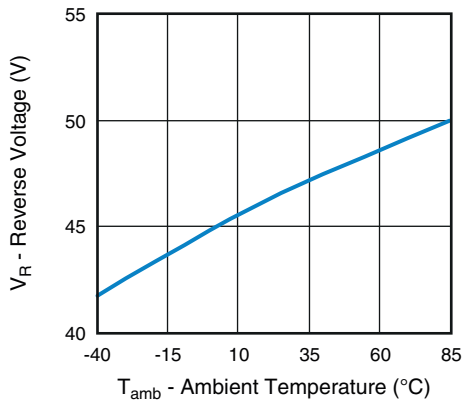


Fig. 5 - Reverse Voltage vs. Ambient Temperature



Fig. 8 - Normalized Trigger Input Current vs. Ambient Temperature

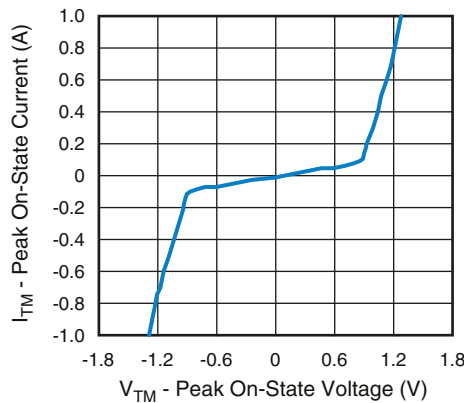


Fig. 6 - On-State Current vs. On-State Voltage

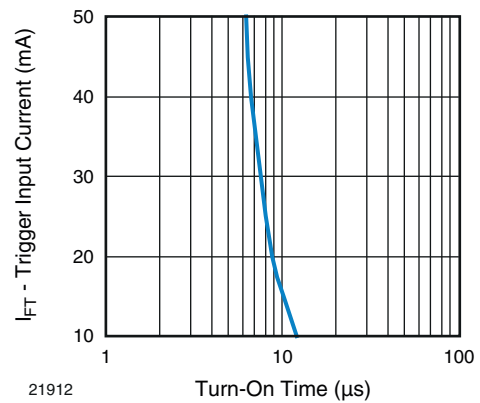


Fig. 9 - Trigger Input Current vs. Turn-On Time



Fig. 10 - Normalized Holding Current vs. Ambient Temperature



Fig. 11 - Trigger Input Current vs. Trigger Pulse Width

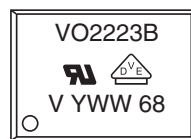


Fig. 12 - Trigger Input Current vs. Terminal Voltage

**PACKAGE DIMENSIONS** (in millimeters)



**PACKAGE MARKING** (example of VO2223B-X001)



**Notes**

- The VDE logo is only marked on option 1 parts. Option information is not marked on the part
- Tape and reel suffix (T) is not part of the package marking

**PACKING INFORMATION**

DEVICE PER TUBE			
TYPE	UNITS/TUBE	TUBES/BOX	UNITS/BOX
DIP-8	50	40	2000

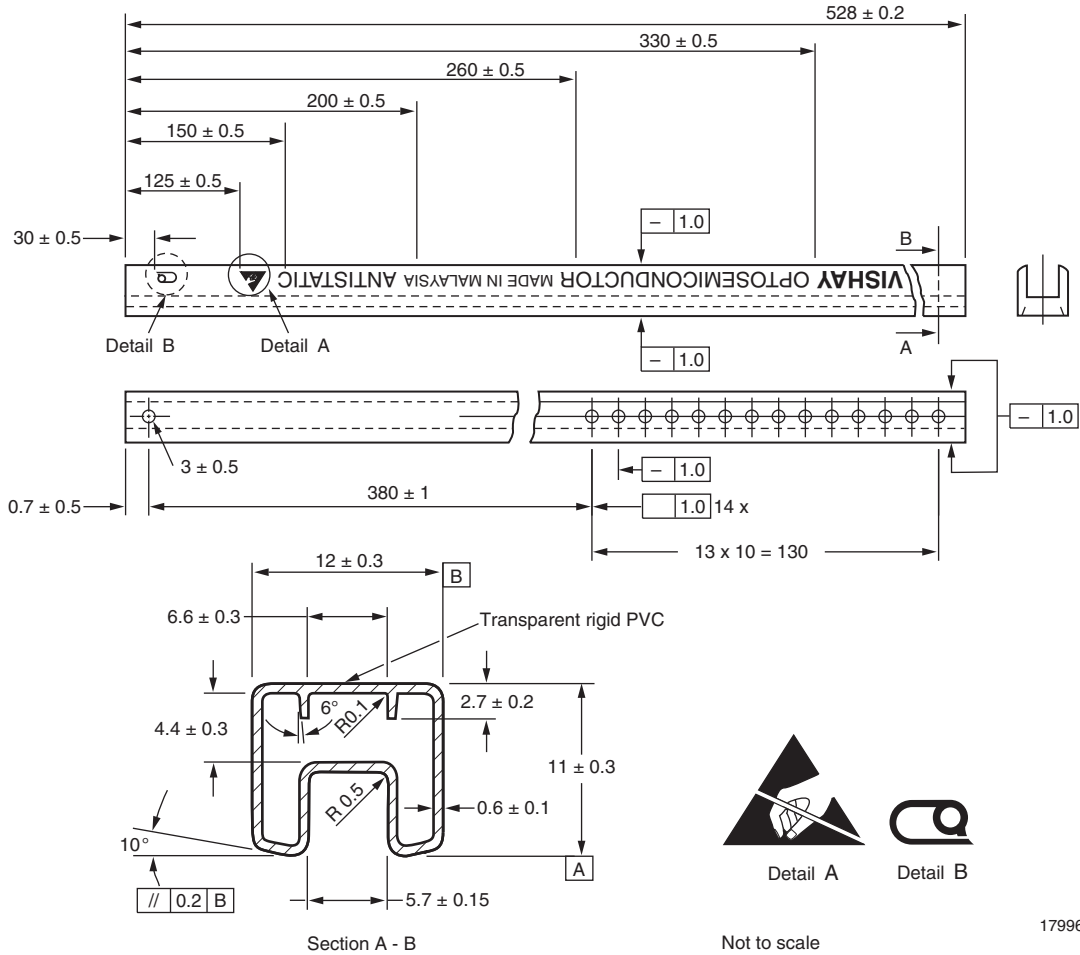
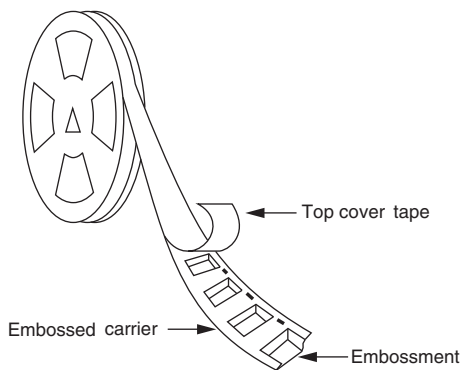
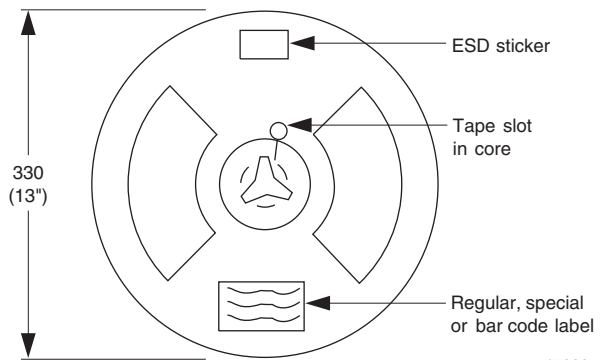


Fig. 13 - Shipping Tube Specifications for DIP Packages



17998

Fig. 14 - Tape and Reel Shipping Medium



17999

Fig. 15 - Tape and Reel Shipping Medium



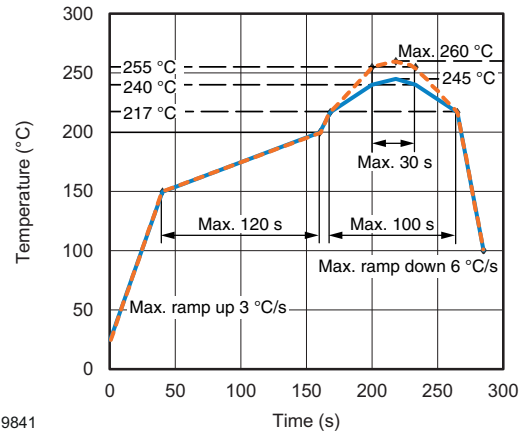
Fig. 16 - Tape and Packing (1000 pieces on reel)

**SOLDER PROFILES**



94 8626

Fig. 17 - Recommended Wave Soldering Double Wave Profile for DIP Devices



19841

Fig. 18 - Recommended Lead (Pb)-free Reflow Solder Profile for SMD Devices

**HANDLING AND STORAGE CONDITIONS**

ESD level: HBM class 2

Floor life: unlimited

Conditions:  $T_{amb} < 30\text{ °C}$ , RH < 85 %

Moisture sensitivity level 1, according to J-STD-020





## **Disclaimer**

ALL PRODUCT, PRODUCT SPECIFICATIONS AND DATA ARE SUBJECT TO CHANGE WITHOUT NOTICE TO IMPROVE RELIABILITY, FUNCTION OR DESIGN OR OTHERWISE.

Vishay Intertechnology, Inc., its affiliates, agents, and employees, and all persons acting on its or their behalf (collectively, "Vishay"), disclaim any and all liability for any errors, inaccuracies or incompleteness contained in any datasheet or in any other disclosure relating to any product.

Vishay makes no warranty, representation or guarantee regarding the suitability of the products for any particular purpose or the continuing production of any product. To the maximum extent permitted by applicable law, Vishay disclaims (i) any and all liability arising out of the application or use of any product, (ii) any and all liability, including without limitation special, consequential or incidental damages, and (iii) any and all implied warranties, including warranties of fitness for particular purpose, non-infringement and merchantability.

Statements regarding the suitability of products for certain types of applications are based on Vishay's knowledge of typical requirements that are often placed on Vishay products in generic applications. Such statements are not binding statements about the suitability of products for a particular application. It is the customer's responsibility to validate that a particular product with the properties described in the product specification is suitable for use in a particular application. Parameters provided in datasheets and / or specifications may vary in different applications and performance may vary over time. All operating parameters, including typical parameters, must be validated for each customer application by the customer's technical experts. Product specifications do not expand or otherwise modify Vishay's terms and conditions of purchase, including but not limited to the warranty expressed therein.

Except as expressly indicated in writing, Vishay products are not designed for use in medical, life-saving, or life-sustaining applications or for any other application in which the failure of the Vishay product could result in personal injury or death. Customers using or selling Vishay products not expressly indicated for use in such applications do so at their own risk. Please contact authorized Vishay personnel to obtain written terms and conditions regarding products designed for such applications.

No license, express or implied, by estoppel or otherwise, to any intellectual property rights is granted by this document or by any conduct of Vishay. Product names and markings noted herein may be trademarks of their respective owners.

Компания «Life Electronics» занимается поставками электронных компонентов импортного и отечественного производства от производителей и со складов крупных дистрибьюторов Европы, Америки и Азии.

С конца 2013 года компания активно расширяет линейку поставок компонентов по направлению коаксиальный кабель, кварцевые генераторы и конденсаторы (керамические, пленочные, электролитические), за счёт заключения дистрибьюторских договоров

Мы предлагаем:

- Конкуренспособные цены и скидки постоянным клиентам.
- Специальные условия для постоянных клиентов.
- Подбор аналогов.
- Поставку компонентов в любых объемах, удовлетворяющих вашим потребностям.
- Приемлемые сроки поставки, возможна ускоренная поставка.
- Доставку товара в любую точку России и стран СНГ.
- Комплексную поставку.
- Работу по проектам и поставку образцов.
- Формирование склада под заказчика.
- Сертификаты соответствия на поставляемую продукцию (по желанию клиента).
- Тестирование поставляемой продукции.
- Поставку компонентов, требующих военную и космическую приемку.
- Входной контроль качества.
- Наличие сертификата ISO.

В составе нашей компании организован Конструкторский отдел, призванный помогать разработчикам, и инженерам.

Конструкторский отдел помогает осуществить:

- Регистрацию проекта у производителя компонентов.
- Техническую поддержку проекта.
- Защиту от снятия компонента с производства.
- Оценку стоимости проекта по компонентам.
- Изготовление тестовой платы монтаж и пусконаладочные работы.



Тел: +7 (812) 336 43 04 (многоканальный)

Email: [org@lifeelectronics.ru](mailto:org@lifeelectronics.ru)