

120×120×25 mm

San Ace 120  Only standard fans (without sensors) have acquired CSA certification.



General Specifications

- Material Frame: Aluminum, Impeller: Plastic (Flammability: UL 94V-1)
- Expected life See the table below. (L10 life: 90% survival rate for continuous operation in free air at 60°C, rated voltage)
- Motor structure Shaded coil motor
- Motor protection function Locked rotor burnout protection, Reverse polarity protection
For details, please refer to p. 547.
- Dielectric strength 50/60 Hz, 1500 VAC, for 1 minute (between input terminal and frame)
- Dielectric strength (with sensor) 50/60 Hz 1500 VAC 1 minute (between AC input terminal and frame)
50/60 Hz 1000 VAC 1 minute (between lead wire conductors and frame)
- Insulation resistance 10 MΩ or more with a 500 VDC megger
- Sound pressure level (SPL) At 1 m away from the air inlet
- Operating voltage range Voltage of each model ±10%
- Storage temperature -30 to +70°C (Non-condensing)
- Sensor-Purpose lead wire ⊕Brown ⊖Black (Sensor) Yellow
- Mass 370 g/390 g (with Sensor)

Specifications

Standard

Model no.	Rated voltage [V]	Frequency [Hz]	Input [W]	Current [A]	Locked rotor current [A]	Rated speed [min ⁻¹]	Max. airflow [m ³ /min] [CFM]	Max. static pressure [Pa] [inchH ₂ O]	SPL [dB (A)]	Operating temperature [°C]	Expected life [h]
109S085	100	50/60	13.5/12	0.16/0.14	0.19/0.17	2500/2900	1.95/2.3 68.9/81.3	48 /51.9 0.193/0.216	38/41	-30 to +60	25000/60°C
109S084	115			0.14/0.12	0.16/0.15						
109S088	200			0.08/0.07	0.1 /0.09						
109S087	230			0.07/0.06	0.08/0.07						
109S081	100	9.5/8.5	12/10	0.11	0.11/0.1	2200/2350	1.7 /1.8 60.1/63.6	29.4/26.5 0.118/0.106	34/35		
109S083	115			0.1	0.1 /0.09						
109S082	200			0.07	0.07/0.06						
109S089	230			0.06	0.06/0.05						
109S086*	100			0.14/0.12	0.15/0.13	1400/1600	1.1 /1.25 38.9/44.2	14.7/18.6 0.059/0.075	24/27		

* These are low-speed models.

with Sensor

For sensor specifications, please refer to p. 550. Sensor specification differs depending on the fan's speed specification.

For a 5 V sensor power supply (ITEM-20), please append "-20" to the end of model number. E.g. 109S485-20

For a 12 V sensor power supply (ITEM-30), please append "-30" to the end of model number. E.g. 109S485-30

Model no.	Rated voltage [V]	Frequency [Hz]	Input [W]	Current [A]	Locked rotor current [A]	Rated speed [min ⁻¹]	Max. airflow [m ³ /min] [CFM]	Max. static pressure [Pa] [inchH ₂ O]	SPL [dB (A)]	Operating temperature [°C]	Expected life [h]
109S485	100	50/60	13.5/12	0.16/0.14	0.19/0.17	2500/2900	1.95/2.3 68.9/81.3	48 /51.9 0.193/0.216	38/41	-10 to +60	25000/60°C
109S484	115			0.14/0.12	0.16/0.15						
109S488	200			0.08/0.07	0.1 /0.09						
109S487	230			0.07/0.06	0.08/0.07						
109S486*	100			0.14/0.12	0.15/0.13	1400/1600	1.1 /1.25 38.9/44.2	14.7/18.6 0.059/0.075	24/27		

* These are low-speed models.

Set Models

Fan, finger guard, plug cord, screws, etc. can be purchased in one package. For details, please refer to p. 594.

Order no.	Set items					
	Fan	Voltage	Low-speed sensor	Plug cord*	Finger guards	Mounting screws
ST1-109S085	109S085	100 V		489-016-L10	109-019E	M3×40 mm (4 screws)
ST1-109S084	109S084	115 V		489-016-L10	109-019E	
ST1-109S088	109S088	200 V		489-016-L10	109-019E	
ST1-109S087	109S087	230 V		489-016-L10	109-019E	
ST1-109S081	109S081	100 V		489-016-L10	109-019E	
ST1-109S083	109S083	115 V		489-016-L10	109-019E	
ST1-109S082	109S082	200 V		489-016-L10	109-019E	
ST1-109S089	109S089	230 V		489-016-L10	109-019E	
ST1-109S086	109S086			489-016-L10	109-019E	
ST1-109S485-20	109S485-20	100 V	○ (5 V)	489-016-L10	109-019E	
ST1-109S485-30	109S485-30		○ (12 V)	489-016-L10	109-019E	
ST1-109S484-20	109S484-20	115 V	○ (5 V)	489-016-L10	109-019E	
ST1-109S484-30	109S484-30		○ (12 V)	489-016-L10	109-019E	
ST1-109S488-20	109S488-20	200 V	○ (5 V)	489-016-L10	109-019E	
ST1-109S488-30	109S488-30		○ (12 V)	489-016-L10	109-019E	
ST1-109S487-20	109S487-20	230 V	○ (5 V)	489-016-L10	109-019E	
ST1-109S487-30	109S487-30		○ (12 V)	489-016-L10	109-019E	
ST1-109S486-20	109S486-20	100 V	○ (5 V)	489-016-L10	109-019E	
ST1-109S486-30	109S486-30		○ (12 V)	489-016-L10	109-019E	

* PSE compatible.

Airflow - Static Pressure Characteristics

Standard

109S085, 109S084, 109S088, 109S087

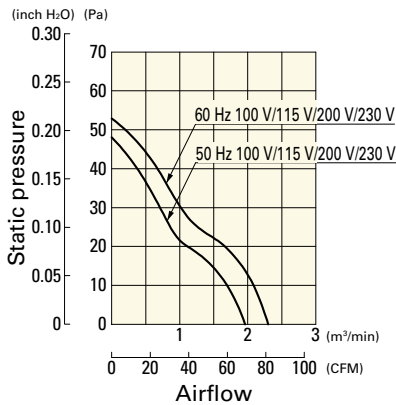

109S081, 109S083, 109S082, 109S089

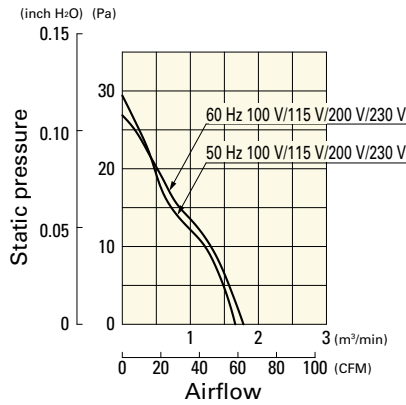

109S086

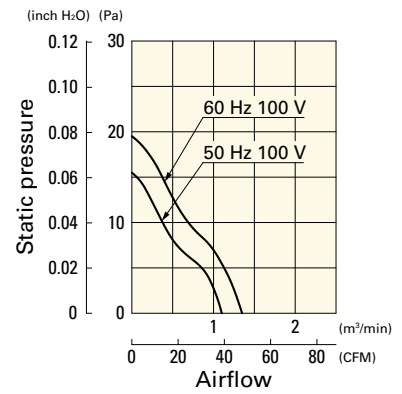

with Sensor

109S485, 109S484, 109S488, 109S487

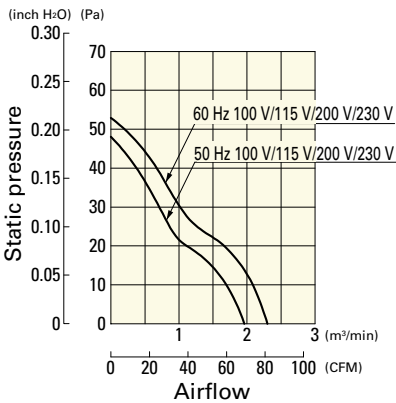

109S486

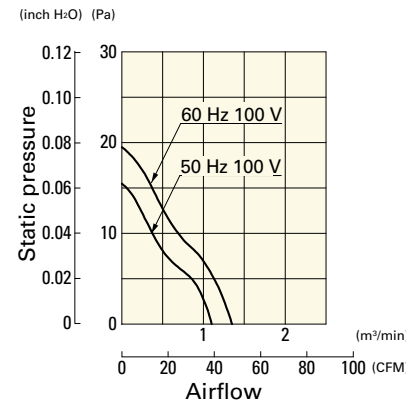

Dimensions (unit: mm)

Standard



with Sensor When mounting the model with a sensor, please screw-mount through both flanges as it has a sensor box.



Reference Dimensions of Mounting Holes and Vent Opening (unit: mm)

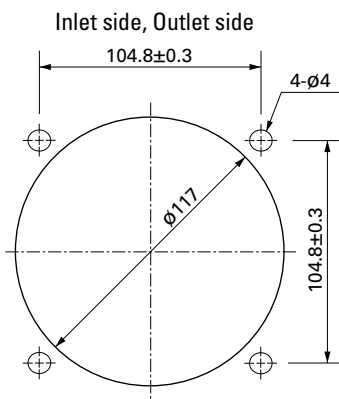

Wiring Diagram

Standard

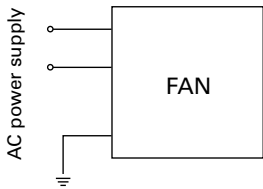

with Sensor

For fan power supply

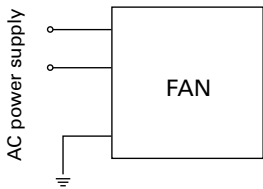

For sensor circuit
5 V (ITEM-20)

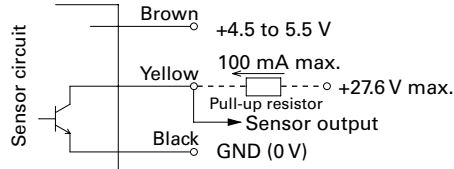

12 V (ITEM-30)

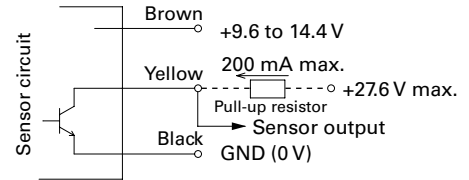

GND (Black) should be shared in case that power supply for sensor circuit (Brown) and that for sensor pull-up (Yellow) are separated.

Options

Finger guards

page: p. 533

Model no.: 109-019E, 109-019K, 109-019C, 109-019H

Resin finger guards

page: p. 539

Model no.: 109-1000G

Resin filter kits

page: p. 540

Model no.: 109-1000F13 (13PPI), 109-1000F20 (20PPI),
109-1000F30 (30PPI), 109-1000F40 (40PPI)

Plug cord

page: pp. 542 to 543

Model no.: 489-016-L10, 489-016-L21, 489-047-L10,
489-047-L21

Компания «Life Electronics» занимается поставками электронных компонентов импортного и отечественного производства от производителей и со складов крупных дистрибьюторов Европы, Америки и Азии.

С конца 2013 года компания активно расширяет линейку поставок компонентов по направлению коаксиальный кабель, кварцевые генераторы и конденсаторы (керамические, пленочные, электролитические), за счёт заключения дистрибьюторских договоров

Мы предлагаем:

- Конкуренспособные цены и скидки постоянным клиентам.
- Специальные условия для постоянных клиентов.
- Подбор аналогов.
- Поставку компонентов в любых объемах, удовлетворяющих вашим потребностям.
- Приемлемые сроки поставки, возможна ускоренная поставка.
- Доставку товара в любую точку России и стран СНГ.
- Комплексную поставку.
- Работу по проектам и поставку образцов.
- Формирование склада под заказчика.
- Сертификаты соответствия на поставляемую продукцию (по желанию клиента).
- Тестирование поставляемой продукции.
- Поставку компонентов, требующих военную и космическую приемку.
- Входной контроль качества.
- Наличие сертификата ISO.

В составе нашей компании организован Конструкторский отдел, призванный помогать разработчикам, и инженерам.

Конструкторский отдел помогает осуществить:

- Регистрацию проекта у производителя компонентов.
- Техническую поддержку проекта.
- Защиту от снятия компонента с производства.
- Оценку стоимости проекта по компонентам.
- Изготовление тестовой платы монтаж и пусконаладочные работы.



Тел: +7 (812) 336 43 04 (многоканальный)

Email: org@lifeelectronics.ru