

MECHANICAL DATA

**GOLD METALLISED  
MULTI-PURPOSE SILICON  
DMOS RF FET  
350W – 28V – 175MHz  
PUSH-PULL**

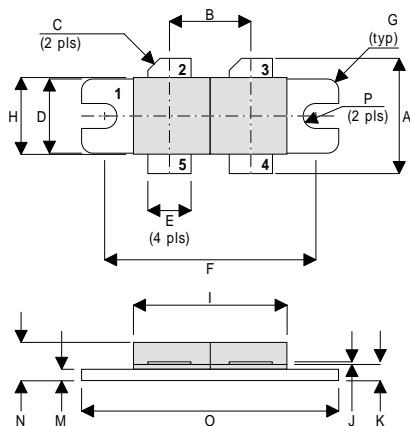

DR

PIN 1 SOURCE (COMMON)      PIN 2 DRAIN 1  
 PIN 3 DRAIN 2                      PIN 4 GATE 2  
 PIN 5 GATE 1

DIM	Millimetres	Tol.	Inches	Tol.
A	19.05	0.50	0.75	0.020
B	10.77	0.13	0.424	0.005
C	45°	5°	45°	5°
D	9.78	0.13	0.385	0.005
E	5.71	0.13	0.225	0.005
F	27.94	0.13	1.100	0.005
G	1.52R	0.13	0.060R	0.005
H	10.16	0.13	0.400	0.005
I	22.22	MAX	0.875	MAX
J	0.13	0.02	0.005	0.001
K	2.72	0.13	0.107	0.005
M	1.70	0.13	0.067	0.005
N	5.08	0.50	0.200	0.020
O	34.03	0.13	1.340	0.005
P	1.61R	0.08	0.064R	0.003

FEATURES

- SIMPLIFIED AMPLIFIER DESIGN
- SUITABLE FOR BROAD BAND APPLICATIONS
- LOW  $C_{rss}$
- SIMPLE BIAS CIRCUITS
- LOW NOISE
- HIGH GAIN – 13 dB MINIMUM

APPLICATIONS

- VHF/UHF COMMUNICATIONS  
from 1 MHz to 200 MHz

ABSOLUTE MAXIMUM RATINGS ( $T_{case} = 25^{\circ}C$  unless otherwise stated)

$P_D$	Power Dissipation	438W
$BV_{DSS}$	Drain – Source Breakdown Voltage *	70V
$BV_{GSS}$	Gate – Source Breakdown Voltage *	±20V
$I_{D(sat)}$	Drain Current *	35A
$T_{stg}$	Storage Temperature	-65 to 150°C
$T_j$	Maximum Operating Junction Temperature	200°C

\* Per Side

Semelab Plc reserves the right to change test conditions, parameter limits and package dimensions without notice. Information furnished by Semelab is believed to be both accurate and reliable at the time of going to press. However Semelab assumes no responsibility for any errors or omissions discovered in its use. Semelab encourages customers to verify that datasheets are current before placing orders.

## ELECTRICAL CHARACTERISTICS (T<sub>case</sub> = 25°C unless otherwise stated)

Parameter		Test Conditions		Min.	Typ.	Max.	Unit
<b>PER SIDE</b>							
B <sub>V</sub> DSS	Drain–Source Breakdown Voltage	V <sub>GS</sub> = 0	I <sub>D</sub> = 100mA	70			V
I <sub>D</sub> DSS	Zero Gate Voltage Drain Current	V <sub>DS</sub> = 28V	V <sub>GS</sub> = 0			7	mA
I <sub>G</sub> DSS	Gate Leakage Current	V <sub>GS</sub> = 20V	V <sub>DS</sub> = 0			7	μA
V <sub>GS(th)</sub>	Gate Threshold Voltage*	I <sub>D</sub> = 10mA	V <sub>DS</sub> = V <sub>GS</sub>	1		7	V
g <sub>fs</sub>	Forward Transconductance*	V <sub>DS</sub> = 10V	I <sub>D</sub> = 7A	5.6			S
<b>TOTAL DEVICE</b>							
G <sub>PS</sub>	Common Source Power Gain	P <sub>O</sub> = 350W		13			dB
η	Drain Efficiency	V <sub>DS</sub> = 28V	I <sub>DQ</sub> = 2A	65			%
VSWR	Load Mismatch Tolerance	f = 175MHz		20:1			—
<b>PER SIDE</b>							
C <sub>iss</sub>	Input Capacitance	V <sub>DS</sub> = 28V	V <sub>GS</sub> = -5V f = 1MHz			420	pF
C <sub>oss</sub>	Output Capacitance	V <sub>DS</sub> = 28V	V <sub>GS</sub> = 0 f = 1MHz			210	pF
C <sub>rss</sub>	Reverse Transfer Capacitance	V <sub>DS</sub> = 28V	V <sub>GS</sub> = 0 f = 1MHz			17.5	pF

\* Pulse Test: Pulse Duration = 300 μs , Duty Cycle ≤ 2%

## HAZARDOUS MATERIAL WARNING

The ceramic portion of the device between leads and metal flange is beryllium oxide. Beryllium oxide dust is highly toxic and care must be taken during handling and mounting to avoid damage to this area.

**THESE DEVICES MUST NEVER BE THROWN AWAY WITH GENERAL INDUSTRIAL OR DOMESTIC WASTE.**

## THERMAL DATA

R <sub>THj-case</sub>	Thermal Resistance Junction – Case	Max. 0.4°C / W
-----------------------	------------------------------------	----------------

Semelab Plc reserves the right to change test conditions, parameter limits and package dimensions without notice. Information furnished by Semelab is believed to be both accurate and reliable at the time of going to press. However Semelab assumes no responsibility for any errors or omissions discovered in its use. Semelab encourages customers to verify that datasheets are current before placing orders.

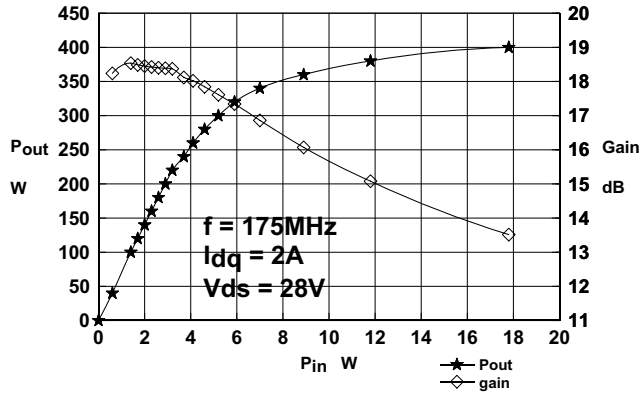

**Figure 1**  
Output Power and Gain vs. Input Power

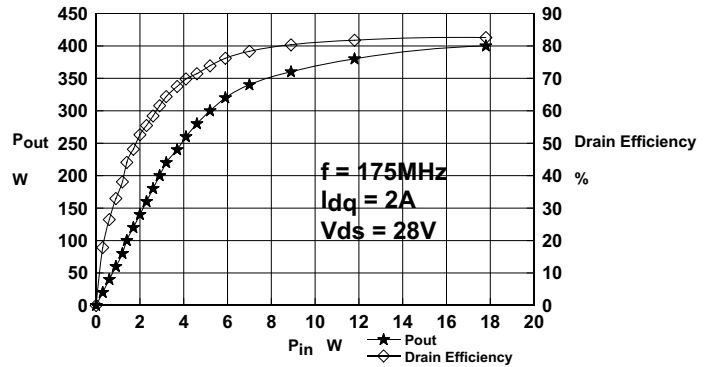

**Figure 2**  
Output Power and Efficiency vs. Input Power

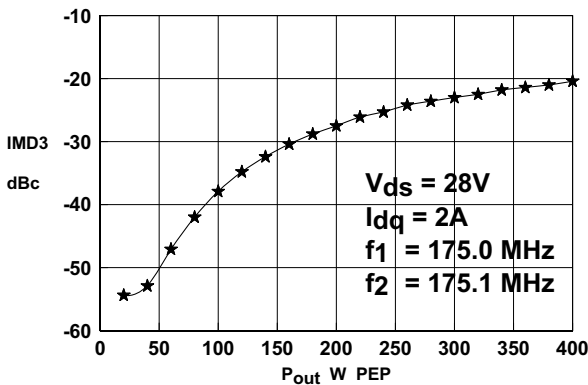

**Figure 3**  
IMD3 vs. Output Power

**OPTIMUM SOURCE AND LOAD IMPEDANCE**

Frequency MHz	Z <sub>S</sub> Ω	Z <sub>L</sub> Ω
175	2.1 + j1.9	2.8 + j2.4
225	1.8 - j0.5	2.9 + j0.7

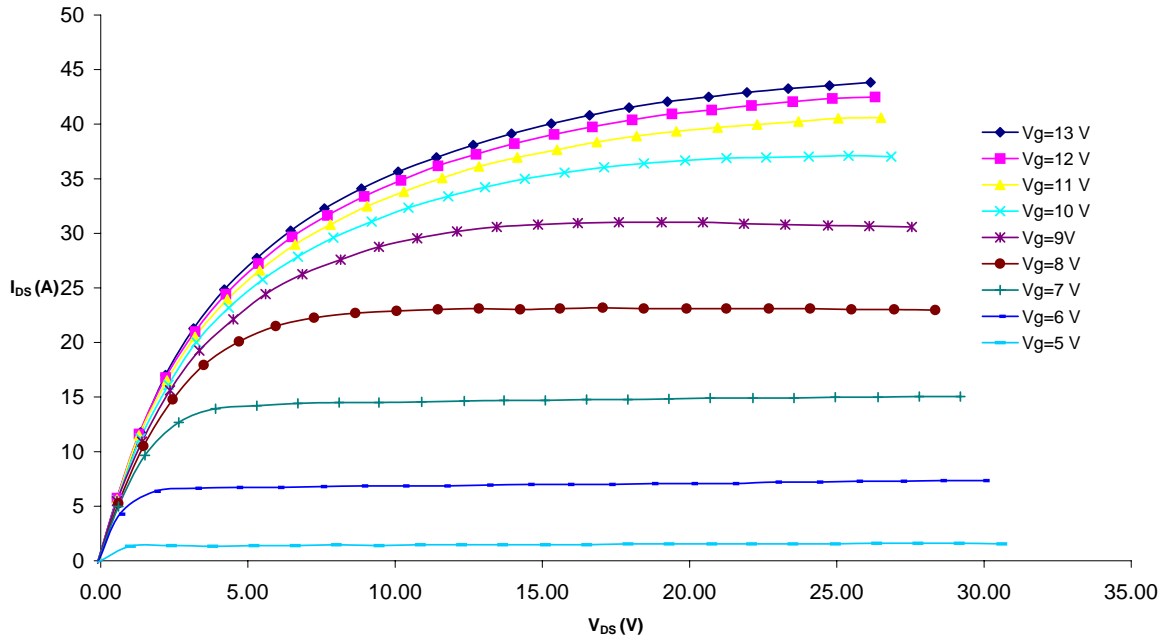

Figure 4 – Typical IV Characteristics.

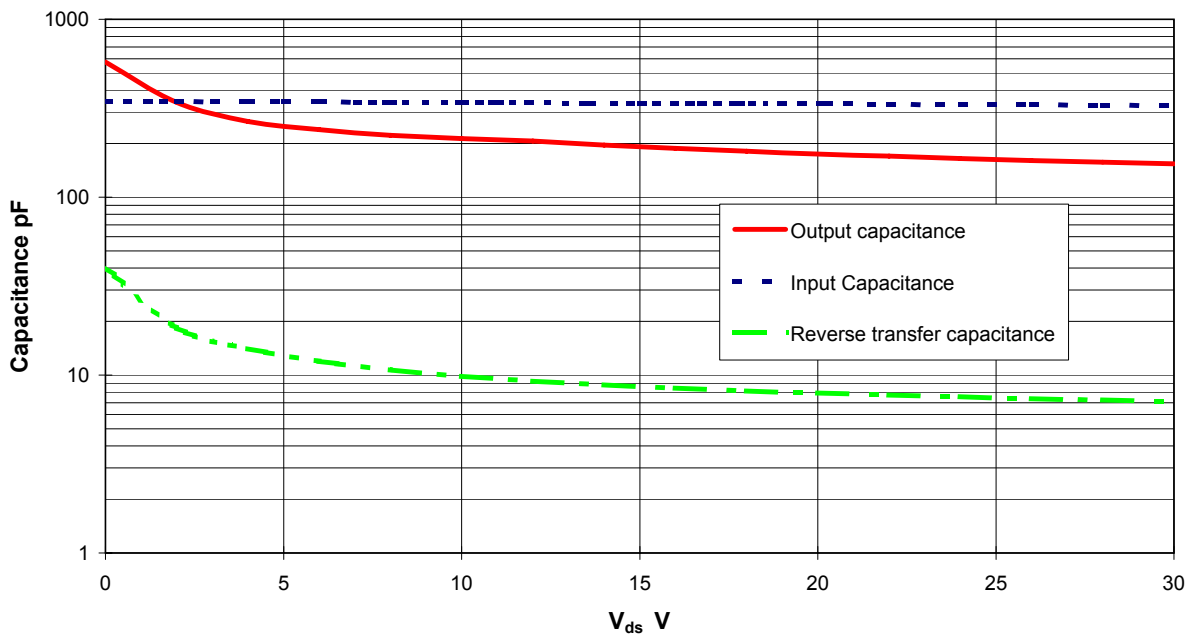
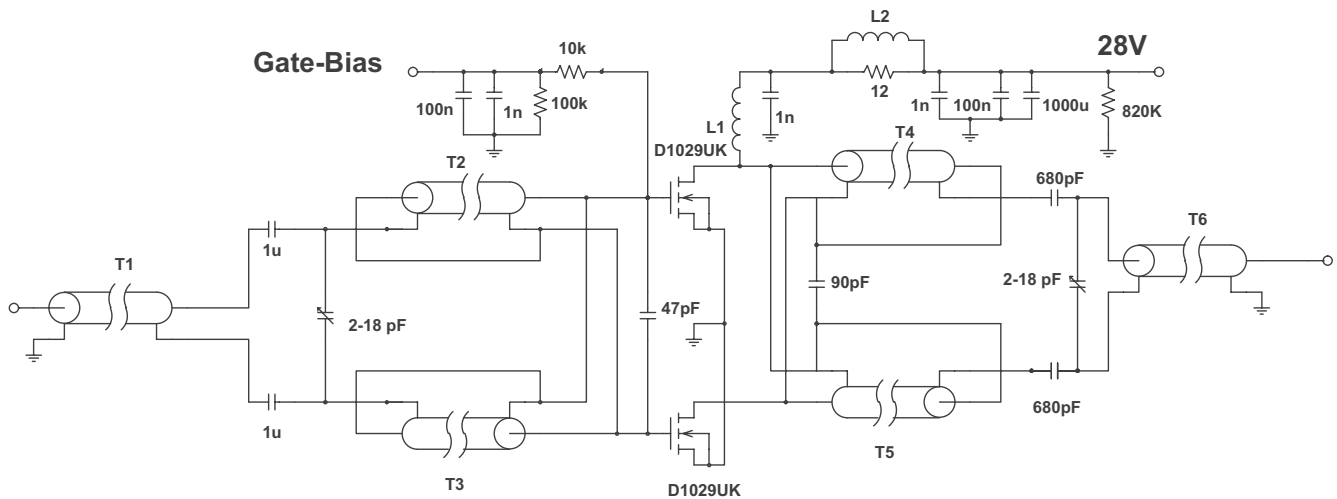

Figure 5 – Typical CV Characteristics.

Semelab Plc reserves the right to change test conditions, parameter limits and package dimensions without notice. Information furnished by Semelab is believed to be both accurate and reliable at the time of going to press. However Semelab assumes no responsibility for any errors or omissions discovered in its use. Semelab encourages customers to verify that datasheets are current before placing orders.



## 175MHz Test Fixture

- T1, 2, 3, 7cm Storm Products EXE18 19/30 S1TW coaxial cable on Siemens B62152A1X1 2 hole core
- T4,5 14cm Storm Products EXE18 19/30 S1TW coaxial cable
- T6 11cm Storm Products EXE18 19/30 S1TW coaxial cable
- L1 6 turns 1.2mm dia wire, 5mm internal diameter
- L2 1.5 turns 0.9mm dia wire on Siemens A1 x 1 2 hole core

# Mouser Electronics

Authorized Distributor

Click to View Pricing, Inventory, Delivery & Lifecycle Information:

[TT Electronics:](#)

[D1029UK](#)

Компания «Life Electronics» занимается поставками электронных компонентов импортного и отечественного производства от производителей и со складов крупных дистрибьюторов Европы, Америки и Азии.

С конца 2013 года компания активно расширяет линейку поставок компонентов по направлению коаксиальный кабель, кварцевые генераторы и конденсаторы (керамические, пленочные, электролитические), за счёт заключения дистрибьюторских договоров

Мы предлагаем:

- Конкуренеспособные цены и скидки постоянным клиентам.
- Специальные условия для постоянных клиентов.
- Подбор аналогов.
- Поставку компонентов в любых объемах, удовлетворяющих вашим потребностям.
- Приемлемые сроки поставки, возможна ускоренная поставка.
- Доставку товара в любую точку России и стран СНГ.
- Комплексную поставку.
- Работу по проектам и поставку образцов.
- Формирование склада под заказчика.
- Сертификаты соответствия на поставляемую продукцию (по желанию клиента).
- Тестирование поставляемой продукции.
- Поставку компонентов, требующих военную и космическую приемку.
- Входной контроль качества.
- Наличие сертификата ISO.

В составе нашей компании организован Конструкторский отдел, призванный помогать разработчикам, и инженерам.

Конструкторский отдел помогает осуществить:

- Регистрацию проекта у производителя компонентов.
- Техническую поддержку проекта.
- Защиту от снятия компонента с производства.
- Оценку стоимости проекта по компонентам.
- Изготовление тестовой платы монтаж и пусконаладочные работы.



Тел: +7 (812) 336 43 04 (многоканальный)

Email: [org@lifeelectronics.ru](mailto:org@lifeelectronics.ru)