

Typical Applications

The HMC451LC3 is ideal for use as a medium power amplifier for:

- Microwave Radio & VSAT
- Military & Space
- Test Equipment & Sensors
- Fiber Optics
- LO Driver for HMC Mixers

Features

- Gain: 19 dB
- Saturated Power: +21 dBm @ 21% PAE
- Output IP3: +30 dBm
- Single Supply: +5V @ 114 mA
- 50 Ohm Matched Input/Output
- RoHS Compliant 3 x 3 mm SMT package

Functional Diagram

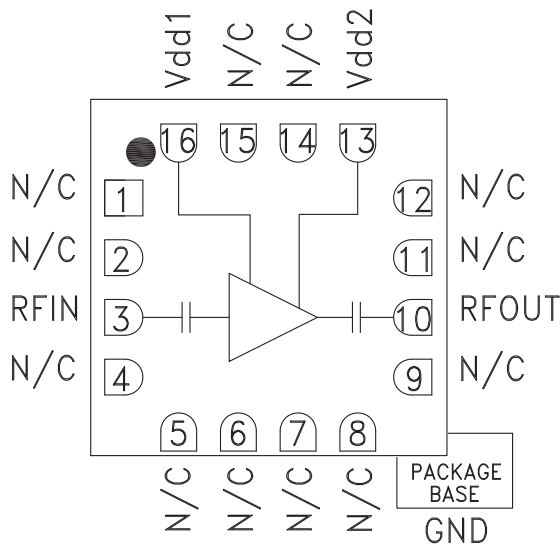

General Description

The HMC451LC3 is an efficient GaAs PHEMT MMIC Medium Power Amplifier housed in a leadless RoHS compliant SMT package. Operating between 5 and 20 GHz, the amplifier provides 19 dB of gain, +21 dBm of saturated power and 21% PAE from a single +5V supply. This 50 Ohm matched amplifier does not require any external components and the RF I/O's are DC blocked, making it an ideal linear gain block or driver for HMC SMT mixers. The HMC451LC3 allows the use of surface mount manufacturing techniques.

Electrical Specifications, $T_A = +25^\circ C$, $V_{dd1} = V_{dd2} = +5V$

Parameter	Min.	Typ.	Max.	Min.	Typ.	Max.	Min.	Typ.	Max.	Units
Frequency Range	5 -15			15 - 18			18 - 20			GHz
Gain	16	19		15	18		14	17		dB
Gain Variation Over Temperature		0.015	0.025		0.015	0.025		0.015	0.025	dB/°C
Input Return Loss		13			13			12		dB
Output Return Loss		12			8			8		dB
Output Power for 1 dB Compression (P1dB)	16.5	19.5		16	19		16.5	19.5		dBm
Saturated Output Power (Psat)		21			20.5			21		dBm
Output Third Order Intercept (IP3)		32			29			29		dBm
Noise Figure		7			6.5			7		dB
Supply Current (Idd)		114			114			114		mA



GaAs PHEMT MMIC MEDIUM POWER AMPLIFIER, 5 - 20 GHz

Broadband Gain & Return Loss

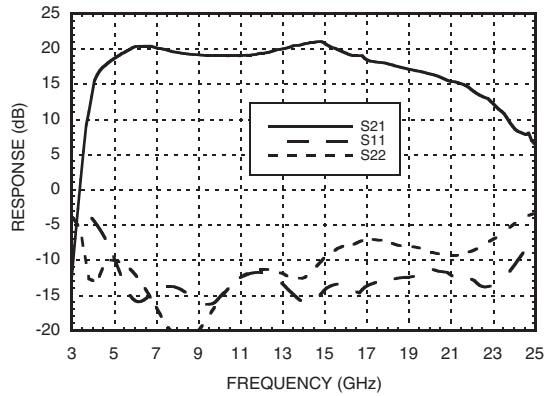

Gain vs. Temperature

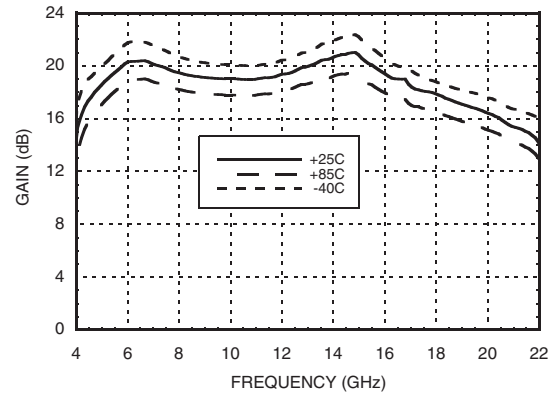

Input Return Loss vs. Temperature

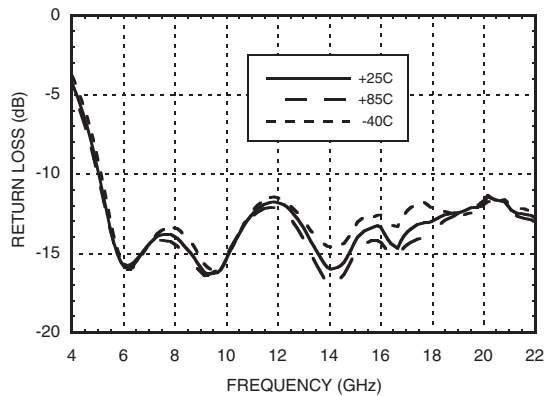

Output Return Loss vs. Temperature

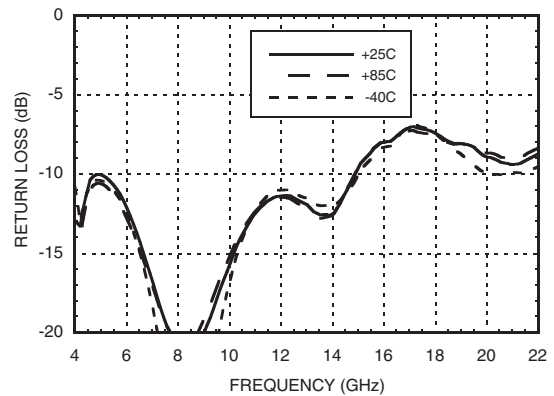

P1dB vs. Temperature

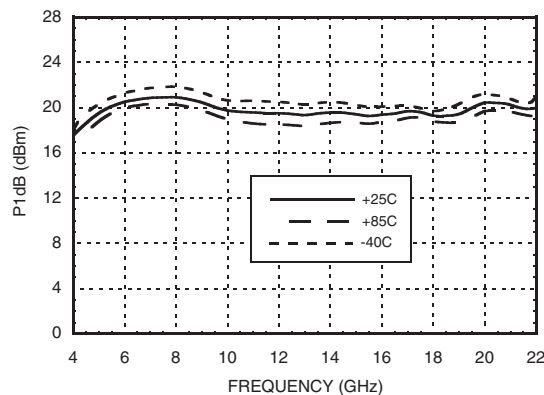

Psat vs. Temperature

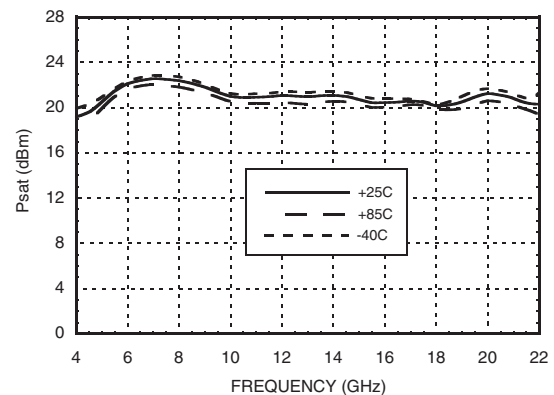

11

LINEAR & POWER AMPLIFIERS - SMT

GaAs PHEMT MMIC MEDIUM POWER AMPLIFIER, 5 - 20 GHz

Power Compression @ 10 GHz

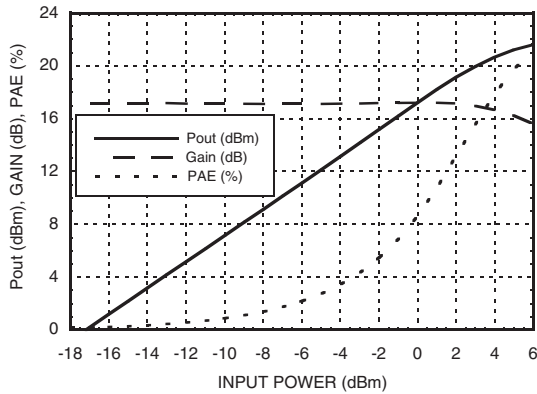

Power Compression @ 20 GHz

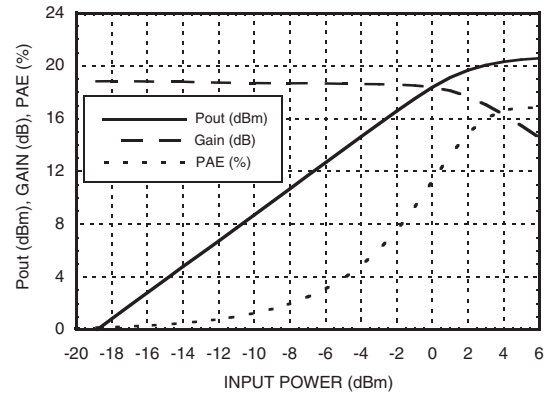

Output IP3 vs. Temperature

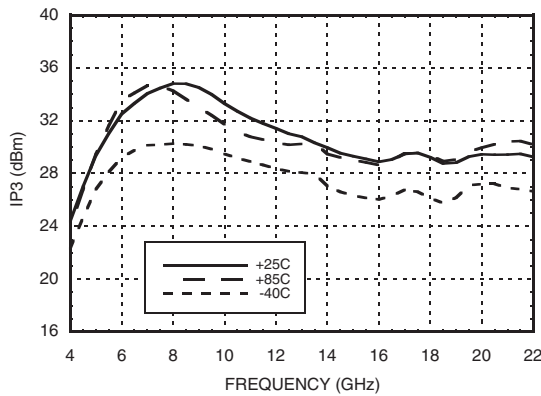

Noise Figure vs. Temperature

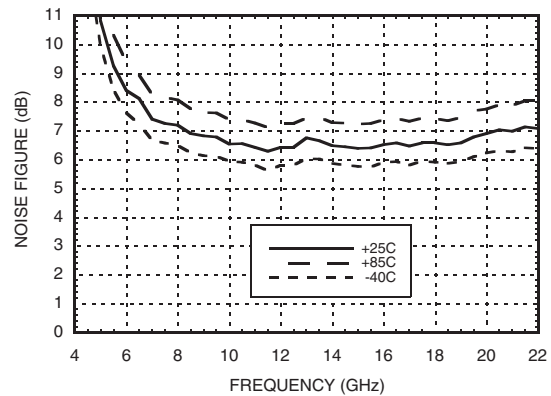

Gain, P1dB & PSAT vs. Supply Voltage @ 11 GHz

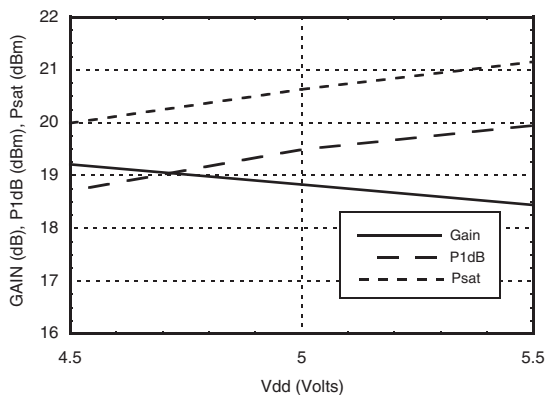

Reverse Isolation vs. Temperature

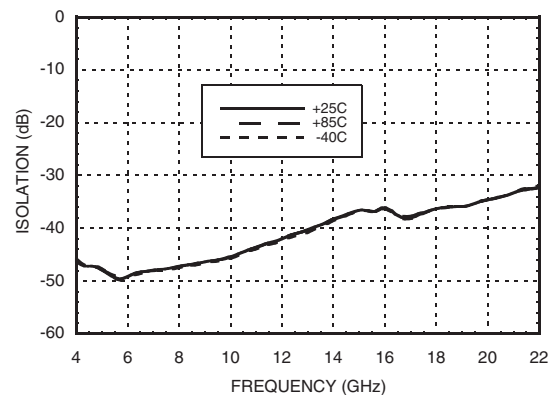

Absolute Maximum Ratings

Drain Bias Voltage (Vdd ₁ = Vdd ₂)	+5.5 Vdc
RF Input Power (RFIN)(Vdd = +5Vdc)	+10 dBm
Channel Temperature	175 °C
Continuous Pdiss (T = 85 °C) (derate 12.4 mW/°C above 85 °C)	1.1 W
Thermal Resistance (channel to ground paddle)	80 °C/W
Storage Temperature	-65 to +150 °C
Operating Temperature	-40 to +85 °C

Typical Supply Current vs. Vdd₁ = Vdd₂

Vdd ₁ = Vdd ₂ (V)	Idd ₁ = Idd ₂ (mA)
+4.5	111
+5.0	114
+5.5	116

Note: Amplifier will operate over full voltage range shown above



ELECTROSTATIC SENSITIVE DEVICE
OBSERVE HANDLING PRECAUTIONS

11

Outline Drawing

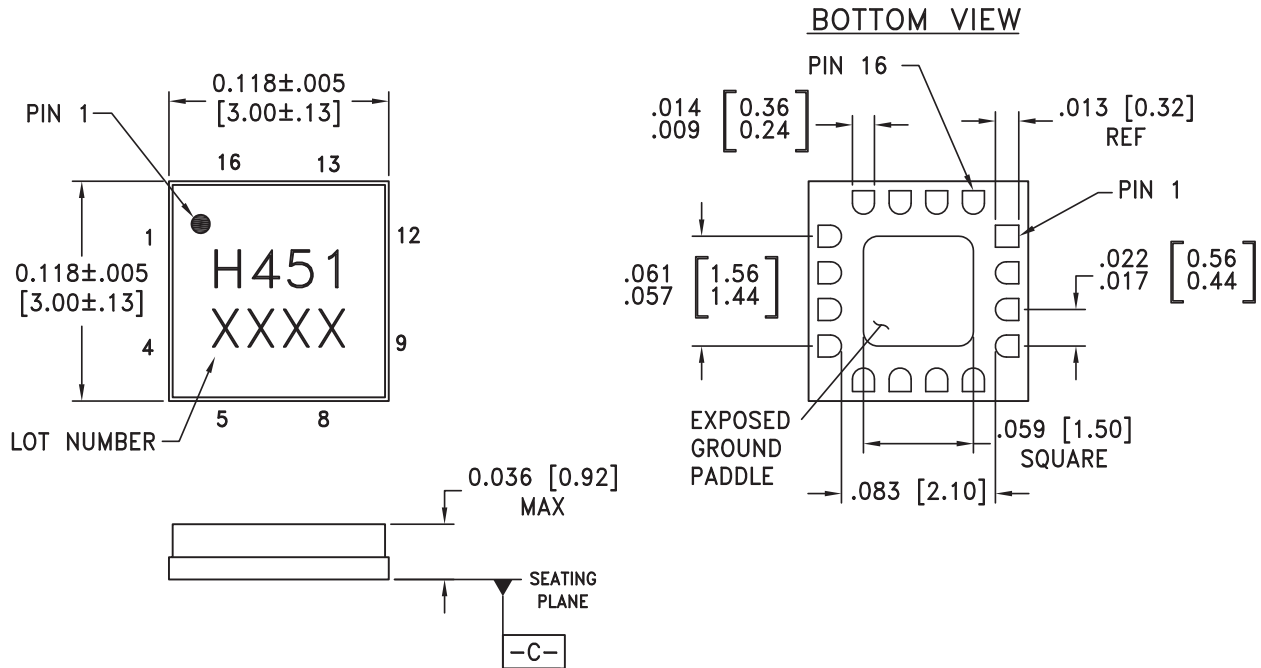



NOTES:

1. PACKAGE BODY MATERIAL: ALUMINA
2. LEAD AND GROUND PADDLE PLATING: 30-80 MICROINCHES GOLD OVER 50 MICROINCHES MINIMUM NICKEL
3. DIMENSIONS ARE IN INCHES [MILLIMETERS].
4. LEAD SPACING TOLERANCE IS NON-CUMULATIVE
5. PACKAGE WARP SHALL NOT EXCEED 0.05mm DATUM -C-
6. ALL GROUND LEADS AND GROUND PADDLE MUST BE SOLDERED TO PCB RF GROUND.

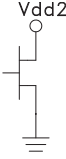
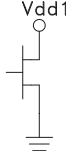

GaAs PHEMT MMIC MEDIUM POWER AMPLIFIER, 5 - 20 GHz

Pin Descriptions

Pin Number	Function	Description	Interface Schematic
1, 2, 4 - 9, 11, 12, 14, 15	N/C	This pin may be connected to RF/DC ground. Performance will not be affected.	
3	RFIN	This pin is AC coupled and matched to 50 Ohms from 5 - 20 GHz.	RFIN ○ — —
10	RFOUT	This pin is AC coupled and matched to 50 Ohms from 5 - 20 GHz.	— — ○ RFOUT
13	Vdd2	Power Supply Voltage for the amplifier. External bypass capacitors of 100 pF, 1,000 pF and 2.2 μF are required.	
16	Vdd1	Power Supply Voltage for the amplifier. External bypass capacitors of 100 pF, 1,000 pF and 2.2 μF are required.	
	GND	Package bottom must be connected to RF/DC ground.	○ GND 

Application Circuit

Component	Value
C1, C2	100 pF
C3, C4	1,000 pF
C5, C6	2.2 μF

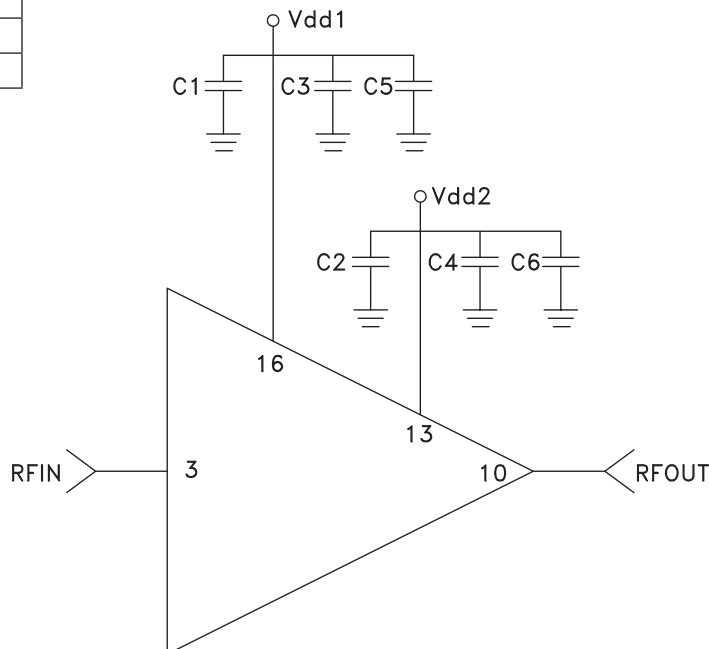

Evaluation PCB

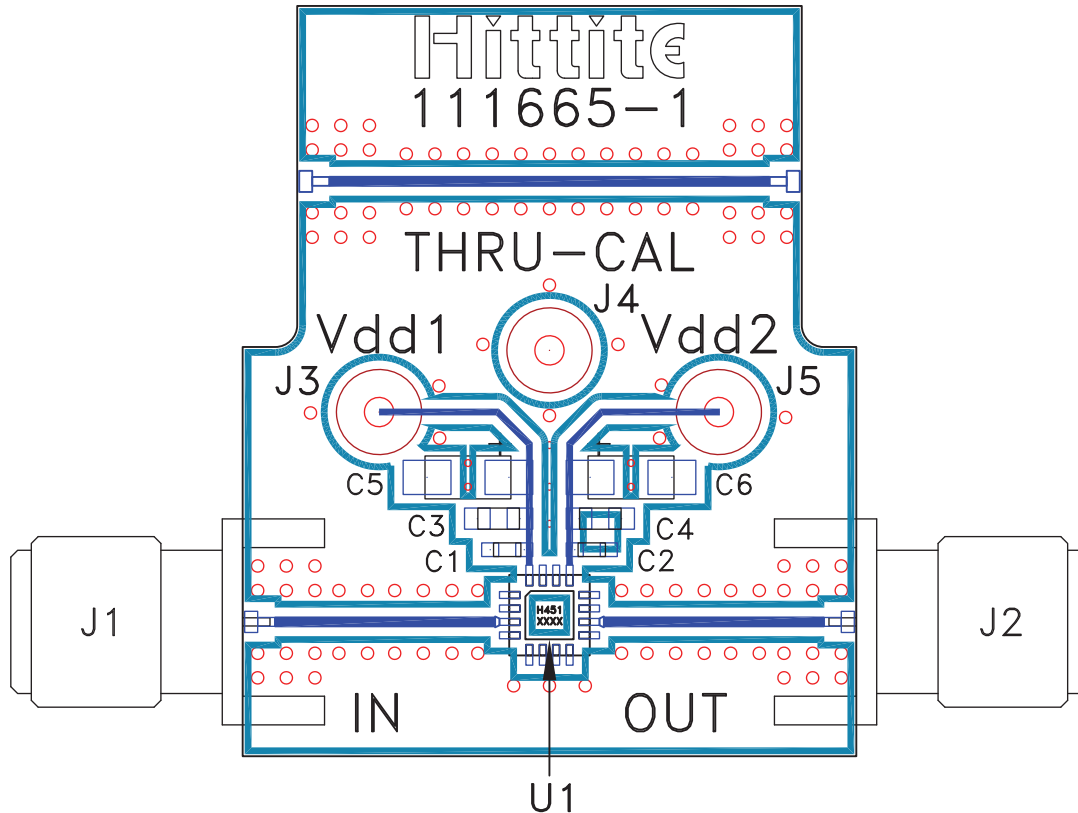

List of Materials for Evaluation PCB 111667 [1]

Item	Description
J1 - J2	PCB Mount SMA Connector
J3 - J5	DC Pin
C1, C2	100 pF Capacitor, 0402 Pkg.
C3, C4	1000 pF Capacitor, 0603 Pkg.
C5, C6	2.2 μ F Capacitor, Tantalum
U1	HMC451LC3 Amplifier
PCB [2]	111665 Evaluation PCB, 10 mils

[1] Reference this number when ordering complete evaluation PCB

[2] Circuit Board Material: Rogers 4350

The circuit board used in the final application should use RF circuit design techniques. Signal lines should have 50 ohm impedance while the package ground leads and exposed paddle should be connected directly to the ground plane similar to that shown. A sufficient number of via holes should be used to connect the top and bottom ground planes. The evaluation board should be mounted to an appropriate heat sink. The evaluation circuit board shown is available from Hittite upon request.

Компания «Life Electronics» занимается поставками электронных компонентов импортного и отечественного производства от производителей и со складов крупных дистрибьюторов Европы, Америки и Азии.

С конца 2013 года компания активно расширяет линейку поставок компонентов по направлению коаксиальный кабель, кварцевые генераторы и конденсаторы (керамические, пленочные, электролитические), за счёт заключения дистрибьюторских договоров

Мы предлагаем:

- Конкурентоспособные цены и скидки постоянным клиентам.
- Специальные условия для постоянных клиентов.
- Подбор аналогов.
- Поставку компонентов в любых объемах, удовлетворяющих вашим потребностям.
- Приемлемые сроки поставки, возможна ускоренная поставка.
- Доставку товара в любую точку России и стран СНГ.
- Комплексную поставку.
- Работу по проектам и поставку образцов.
- Формирование склада под заказчика.
- Сертификаты соответствия на поставляемую продукцию (по желанию клиента).
- Тестирование поставляемой продукции.
- Поставку компонентов, требующих военную и космическую приемку.
- Входной контроль качества.
- Наличие сертификата ISO.

В составе нашей компании организован Конструкторский отдел, призванный помогать разработчикам, и инженерам.

Конструкторский отдел помогает осуществить:

- Регистрацию проекта у производителя компонентов.
- Техническую поддержку проекта.
- Защиту от снятия компонента с производства.
- Оценку стоимости проекта по компонентам.
- Изготовление тестовой платы монтаж и пусконаладочные работы.



Тел: +7 (812) 336 43 04 (многоканальный)

Email: org@lifeelectronics.ru