

FEATURES

- **HIGH GAIN:** 21 dB at 900 to 1500 MHz Typical
- **HIGH OUTPUT POWER:** $P_{SAT} = +12.5$ dBm at 900 MHz
+11 dBm at 1500 MHz
- **LOW BIAS VOLTAGE:** 3.0 V Typical, 2.7 V Minimum
- **SUPER SMALL PACKAGE:** SOT-363
- **TAPE AND REEL PACKAGING OPTION AVAILABLE**

DESCRIPTION

The UPC2771TB is a Silicon Monolithic integrated circuit which is manufactured using the NESAT™ III process. The NESAT III process produces transistors with f_T approaching 20 GHz. The UPC2771TB is pin compatible and has comparable performance as the larger UPC2771T, so it is suitable for use as a replacement to help reduce system size. The IC is housed in a 6 pin super minimold or SOT-363 package. Operating on a 3 volt supply, this IC is ideally suited for hand-held, portable designs.

NEC's stringent quality assurance and test procedures ensure the highest reliability and performance.

GAIN vs. FREQUENCY AND TEMPERATURE

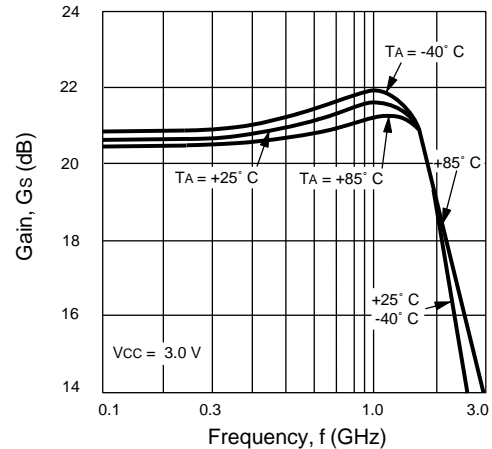

ELECTRICAL CHARACTERISTICS ($T_A = 25^\circ\text{C}$, $Z_L = Z_S = 50\ \Omega$, $V_{CC} = 3.0\text{ V}$)

PART NUMBER PACKAGE OUTLINE			UPC2771TB S06		
SYMBOLS	PARAMETERS AND CONDITIONS	UNITS	MIN	TYP	MAX
I_{CC}	Circuit Current (no signal)	mA		36	45
G_s	Small Signal Gain, $f = 900\text{ MHz}$ $f = 1500\text{ MHz}$	dB dB	19 18	21 21	24 24
f_U	Upper Limit Operating Frequency (The gain at f_U is 3 dB down from the gain at 100 MHz)	GHz	1.8	2.2	
P_{1dB}	1 dB Compressed Output Power, $f = 900\text{ MHz}$ $f = 1500\text{ MHz}$	dBm dBm	+9 +7	+11.5 +9.5	
P_{SAT}	Saturated Output Power, $f = 900\text{ MHz}$ $f = 1500\text{ MHz}$	dBm dBm		+12.5 +11	
NF	Noise Figure, $f = 900\text{ MHz}$ $f = 1500\text{ MHz}$	dB dB		6 6	7.5 7.5
RL_{IN}	Input Return Loss, $f = 900\text{ MHz}$ $f = 1500\text{ MHz}$	dB dB	10 10	14 14	
RL_{OUT}	Output Return Loss, $f = 900\text{ MHz}$ $f = 1500\text{ MHz}$	dB dB	6.5 5.5	9.0 8.5	
ISOL	Isolation, $f = 900\text{ MHz}$ $f = 1500\text{ MHz}$	dB dB	25 25	30 30	
OIP3	SSB Output Third Order Intercept Point $f = 900, 902\text{ MHz}$, $P_{OUT} = +4\text{ dBm}$ $f = 1500, 1502\text{ MHz}$, $P_{OUT} = +4\text{ dBm}$	dBm dBm		+13 +10	
PADJ1	Adjacent Channel Power 1, $f = 900\text{ MHz}$, $\pi/4$ QPSK wave ¹ , $P_{OUT} = +7\text{ dBm}$ $\Delta f = \pm 50\text{ kHz}$ $\Delta f = \pm 100\text{ kHz}$	dBc dBc		-61 -72	
PADJ2	Adjacent Channel Power 2, $f = 1.5\text{ GHz}$, $\pi/4$ QPSK wave ¹ , $P_{OUT} = +7\text{ dBm}$ $\Delta f = \pm 50\text{ kHz}$ $\Delta f = \pm 100\text{ kHz}$	dBc dBc		-59 -72	

Note:

1. $\pi/4$ QPSK modulated wave input, data rate 42 kbps, Filter roll off $\alpha = 0.5$

ABSOLUTE MAXIMUM RATINGS¹ (T_A = 25°C)

SYMBOLS	PARAMETERS	UNITS	RATINGS
V _{CC}	Supply Voltage	V	3.6
I _{CC}	Total Supply Current	mA	77.7
P _{IN}	Input Power	dBm	+13
P _T	Total Power Dissipation ²	mW	200
T _{OP}	Operating Temperature	°C	-40 to +85
T _{STG}	Storage Temperature	°C	-55 to +150

Notes:

1. Operation in excess of any one of these parameters may result in permanent damage.
2. Mounted on a 50 X 50 X 1.6 mm epoxy glass PWB (T_A = 85°C).

RECOMMENDED OPERATING CONDITIONS

SYMBOLS	PARAMETERS	UNITS	MIN	TYP	MAX
V _{CC}	Supply Voltage	V	2.7	3	3.3
T _{OP}	Operating Temperature	°C	-40	+25	+85

TEST CIRCUIT

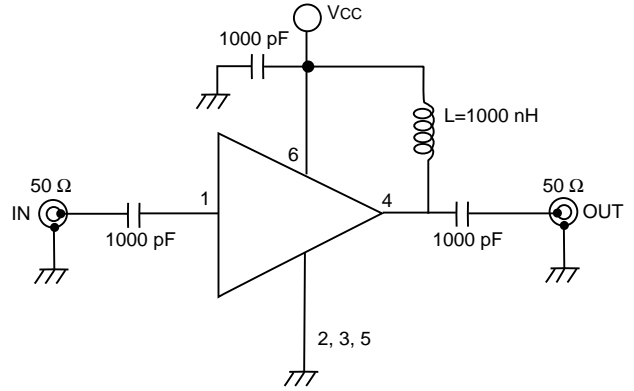

TYPICAL PERFORMANCE CURVES (T_A = 25°C)

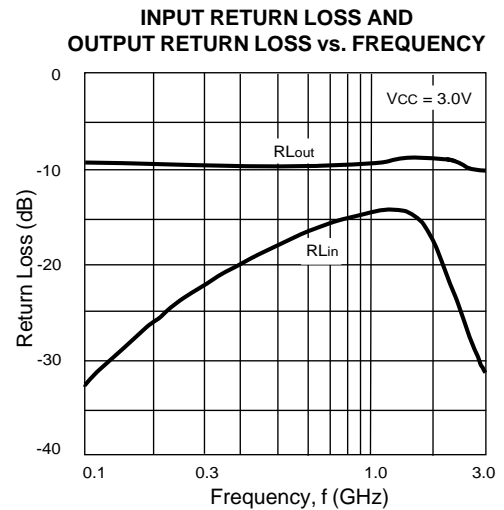
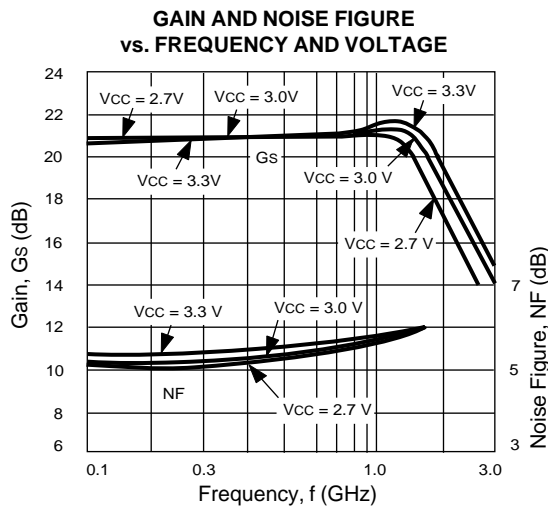
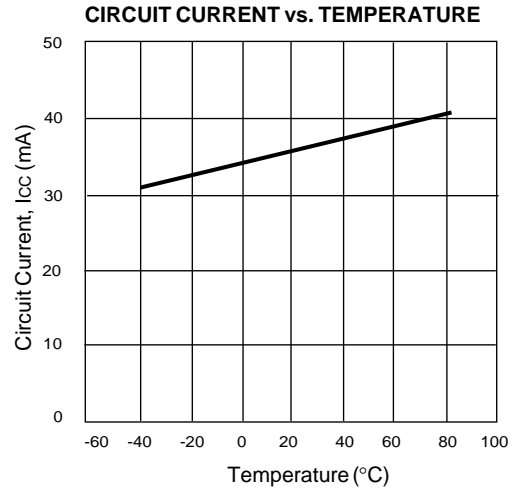
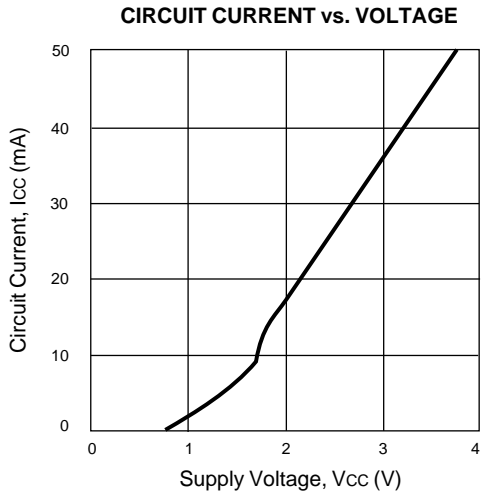

TYPICAL PERFORMANCE CURVES ($T_A = 25^\circ$)

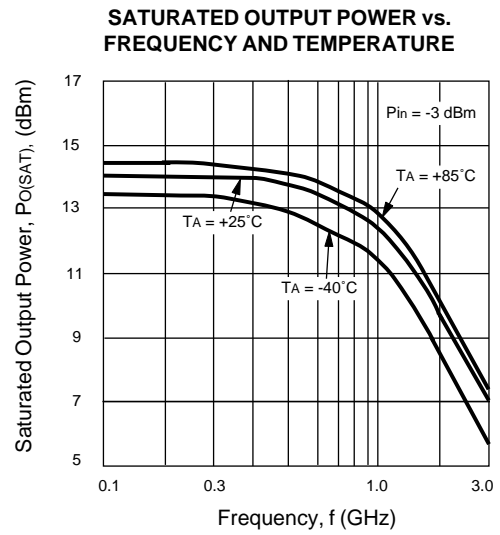
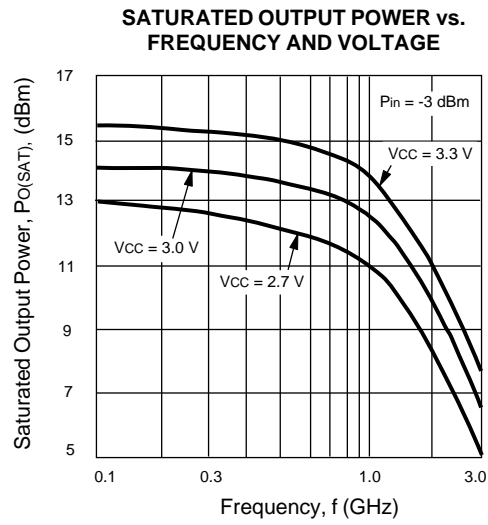
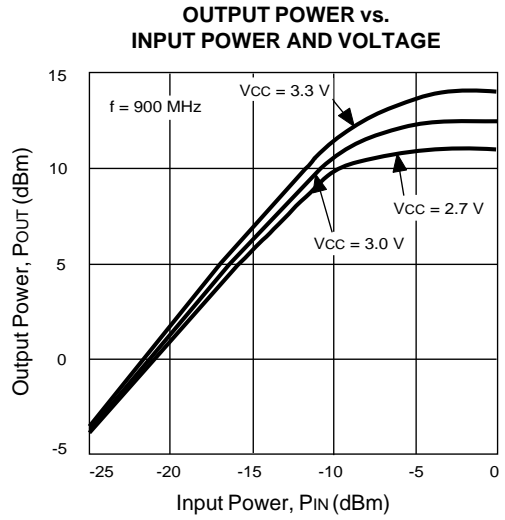
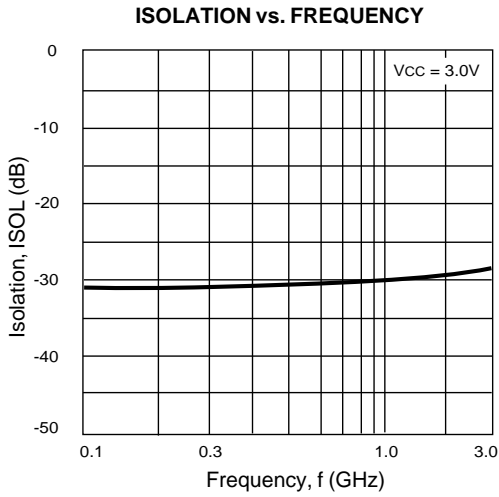

OUTLINE DIMENSIONS (Units in mm)

UPC2771TB
PACKAGE OUTLINE S06

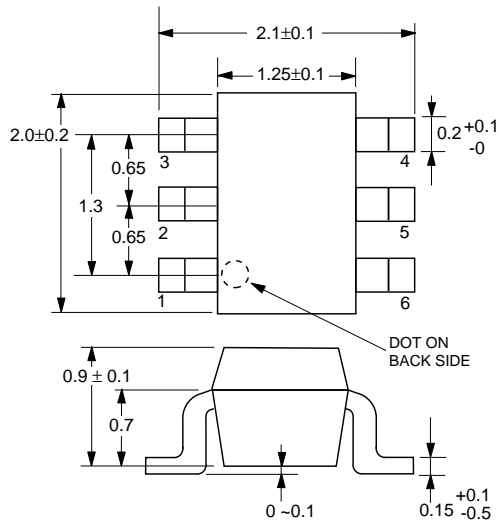

LEAD CONNECTIONS

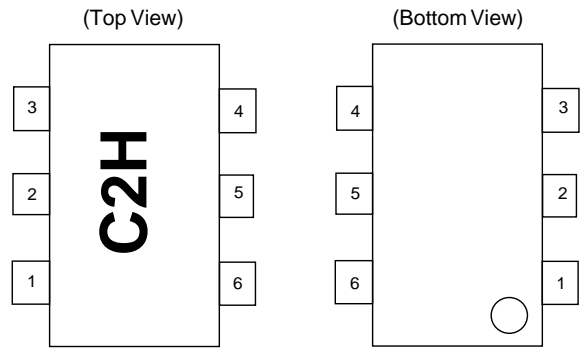

- 1. INPUT
- 2. GND
- 3. GND
- 4. OUTPUT
- 5. GND
- 6. Vcc

PIN DESCRIPTION

Pin No.	Pin Name (V)	Applied Voltage	Description	Internal Equivalent Circuit
1	Input	—	Signal input pin. An internal matching circuit, configured with resistors, enables 50 Ω connection over a wide bandwidth. A multi-feedback circuit is designed to cancel the deviations of hFE and resistance. This pin must be coupled to the signal source with a blocking capacitor.	
4	Output	2.7 to 3.3	Signal output pin. Connect an inductor between this pin and VCC to supply current to the internal output transistors.	
6	VCC		Power supply pin. This pin should be externally equipped with a bypass capacitor to minimize ground impedance.	
2	GND	0	Ground pins. These pins should be connected to system ground with minimum inductance. Ground pattern on the board should be formed as wide as possible. All the ground pins must be connected together with wide ground pattern to minimize impedance difference.	

ORDERING INFORMATION

PART NUMBER	QTY
UPC2771TB-E3	3K/Reel

Note: Embossed Tape, 8 mm wide. Pins 1, 2 and 3 face perforated side of tape.

EXCLUSIVE NORTH AMERICAN AGENT FOR **NEC** RF, MICROWAVE & OPTOELECTRONIC SEMICONDUCTORS

CEL CALIFORNIA EASTERN LABORATORIES • Headquarters • 4590 Patrick Henry Drive • Santa Clara, CA 95054-1817 • (408) 988-3500 • Telex 34-6393 • FAX (408) 988-0279
24-Hour Fax-On-Demand: 800-390-3232 (U.S. and Canada only) • Internet: <http://WWW.CEL.COM>

DATA SUBJECT TO CHANGE WITHOUT NOTICE

PRINTED IN USA ON RECYCLED PAPER -12/97

Компания «Life Electronics» занимается поставками электронных компонентов импортного и отечественного производства от производителей и со складов крупных дистрибьюторов Европы, Америки и Азии.

С конца 2013 года компания активно расширяет линейку поставок компонентов по направлению коаксиальный кабель, кварцевые генераторы и конденсаторы (керамические, пленочные, электролитические), за счёт заключения дистрибьюторских договоров

Мы предлагаем:

- Конкурентоспособные цены и скидки постоянным клиентам.
- Специальные условия для постоянных клиентов.
- Подбор аналогов.
- Поставку компонентов в любых объемах, удовлетворяющих вашим потребностям.
- Приемлемые сроки поставки, возможна ускоренная поставка.
- Доставку товара в любую точку России и стран СНГ.
- Комплексную поставку.
- Работу по проектам и поставку образцов.
- Формирование склада под заказчика.
- Сертификаты соответствия на поставляемую продукцию (по желанию клиента).
- Тестирование поставляемой продукции.
- Поставку компонентов, требующих военную и космическую приемку.
- Входной контроль качества.
- Наличие сертификата ISO.

В составе нашей компании организован Конструкторский отдел, призванный помогать разработчикам, и инженерам.

Конструкторский отдел помогает осуществить:

- Регистрацию проекта у производителя компонентов.
- Техническую поддержку проекта.
- Защиту от снятия компонента с производства.
- Оценку стоимости проекта по компонентам.
- Изготовление тестовой платы монтаж и пусконаладочные работы.



Тел: +7 (812) 336 43 04 (многоканальный)

Email: org@lifeelectronics.ru