

MMBFJ309L, MMBFJ310L, SMMBFJ310L



ON Semiconductor®

<http://onsemi.com>

JFET - VHF/UHF Amplifier Transistor

N-Channel

Features

- AEC-Q101 Qualified and PPAP Capable
- S Prefix for Automotive and Other Applications Requiring Unique Site and Control Change Requirements
- These Devices are Pb-Free, Halogen Free/BFR Free and are RoHS Compliant

MAXIMUM RATINGS

Rating	Symbol	Value	Unit
Drain-Source Voltage	V_{DS}	25	Vdc
Gate-Source Voltage	V_{GS}	25	Vdc
Gate Current	I_G	10	mAdc

THERMAL CHARACTERISTICS

Characteristic	Symbol	Max	Unit
Total Device Dissipation FR-5 Board, (Note 1) $T_A = 25^\circ\text{C}$ Derate above 25°C	P_D	225 1.8	mW mW/ $^\circ\text{C}$
Thermal Resistance, Junction-to-Ambient	$R_{\theta JA}$	556	$^\circ\text{C}/\text{W}$
Junction and Storage Temperature	T_J, T_{stg}	-55 to +150	$^\circ\text{C}$

Stresses exceeding Maximum Ratings may damage the device. Maximum Ratings are stress ratings only. Functional operation above the Recommended Operating Conditions is not implied. Extended exposure to stresses above the Recommended Operating Conditions may affect device reliability.

1. FR-5 = 1.0 x 0.75 x 0.062 in.

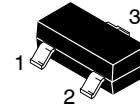
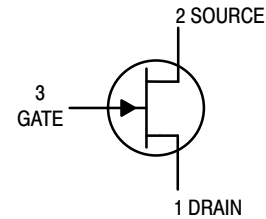

**SOT-23 (TO-236)
CASE 318
STYLE 10**

MARKING DIAGRAM

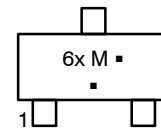

- 6x = Device Code
 x = U for MMBFJ309L
 x = T for MMBFJ310L, SMMBFJ310L
 M = Date Code*
 ■ = Pb-Free Package

(Note: Microdot may be in either location)

*Date Code orientation and/or overbar may vary depending upon manufacturing location.

ORDERING INFORMATION

Device	Package	Shipping†
MMBFJ309LT1G	SOT-23 (Pb-Free)	3,000 / Tape & Reel
MMBFJ310LT1G	SOT-23 (Pb-Free)	3,000 / Tape & Reel
SMMBFJ310LT1G	SOT-23 (Pb-Free)	3,000 / Tape & Reel
SMMBFJ310LT3G	SOT-23 (Pb-Free)	10,000 / Tape & Reel

†For information on tape and reel specifications, including part orientation and tape sizes, please refer to our Tape and Reel Packaging Specifications Brochure, BRD8011/D.

MMBFJ309L, MMBFJ310L, SMMBFJ310L

ELECTRICAL CHARACTERISTICS ($T_A = 25^\circ\text{C}$ unless otherwise noted)

Characteristic	Symbol	Min	Typ	Max	Unit
OFF CHARACTERISTICS					
Gate-Source Breakdown Voltage ($I_G = -1.0 \mu\text{Adc}$, $V_{DS} = 0$)	$V_{(BR)GSS}$	-25	-	-	Vdc
Gate Reverse Current ($V_{GS} = -15 \text{Vdc}$) ($V_{GS} = -15 \text{Vdc}$, $T_A = 125^\circ\text{C}$)	I_{GSS}	-	-	-1.0 -1.0	nAdc μAdc
Gate Source Cutoff Voltage ($V_{DS} = 10 \text{Vdc}$, $I_D = 1.0 \text{nAdc}$)	$V_{GS(off)}$	-1.0 -2.0	-	-4.0 -6.5	Vdc
					MMBFJ309 MMBFJ310, SMMBFJ310
ON CHARACTERISTICS					
Zero-Gate-Voltage Drain Current ($V_{DS} = 10 \text{Vdc}$, $V_{GS} = 0$)	I_{DSS}	12 24	-	30 60	mAdc
					MMBFJ309 MMBFJ310, SMMBFJ310
Gate-Source Forward Voltage ($I_G = 1.0 \text{mAdc}$, $V_{DS} = 0$)	$V_{GS(f)}$	-	-	1.0	Vdc
SMALL-SIGNAL CHARACTERISTICS					
Forward Transfer Admittance ($V_{DS} = 10 \text{Vdc}$, $I_D = 10 \text{mAdc}$, $f = 1.0 \text{kHz}$)	$ Y_{fs} $	8.0	-	18	mmhos
Output Admittance ($V_{DS} = 10 \text{Vdc}$, $I_D = 10 \text{mAdc}$, $f = 1.0 \text{kHz}$)	$ y_{os} $	-	-	250	μmhos
Input Capacitance ($V_{GS} = -10 \text{Vdc}$, $V_{DS} = 0 \text{Vdc}$, $f = 1.0 \text{MHz}$)	C_{iss}	-	-	5.0	pF
Reverse Transfer Capacitance ($V_{GS} = -10 \text{Vdc}$, $V_{DS} = 0 \text{Vdc}$, $f = 1.0 \text{MHz}$)	C_{rss}	-	-	2.5	pF
Equivalent Short-Circuit Input Noise Voltage ($V_{DS} = 10 \text{Vdc}$, $I_D = 10 \text{mAdc}$, $f = 100 \text{Hz}$)	\bar{e}_n	-	10	-	$\text{nV}/\sqrt{\text{Hz}}$

MMBFJ309L, MMBFJ310L, SMMBFJ310L

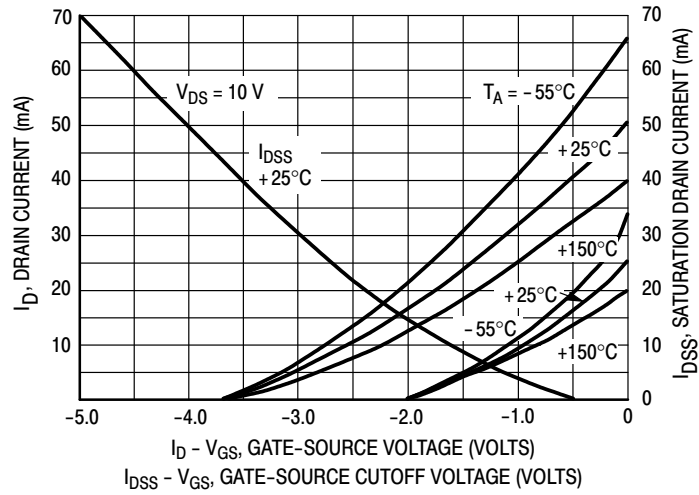

Figure 1. Drain Current and Transfer Characteristics versus Gate-Source Voltage

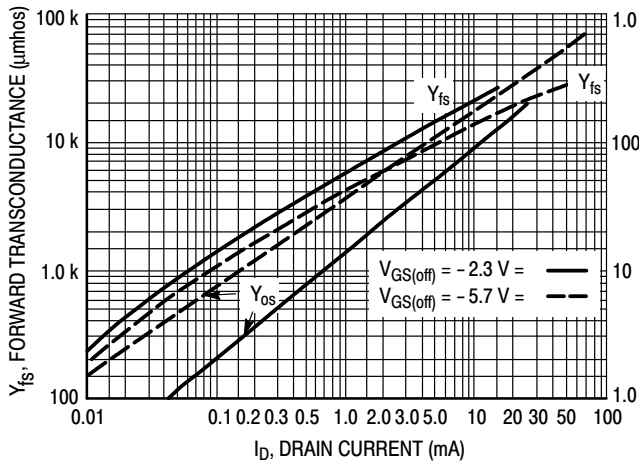

Figure 2. Common-Source Output Admittance and Forward Transconductance versus Drain Current

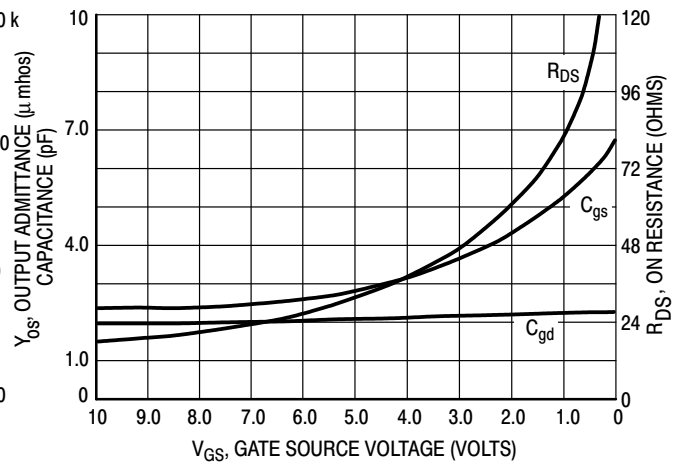

Figure 3. On Resistance and Junction Capacitance versus Gate-Source Voltage

MMBFJ309L, MMBFJ310L, SMMBFJ310L

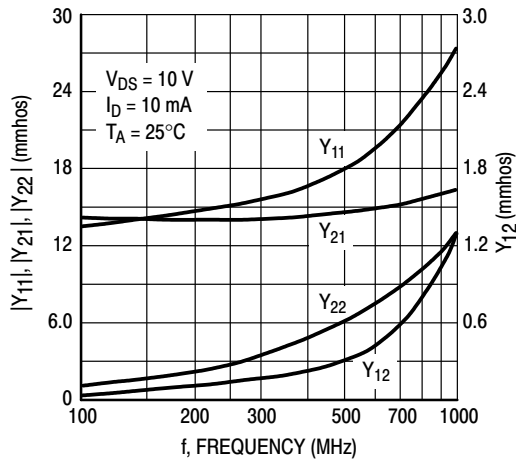

Figure 4. Common-Gate Y Parameter Magnitude versus Frequency



Figure 5. Common-Gate S Parameter Magnitude versus Frequency

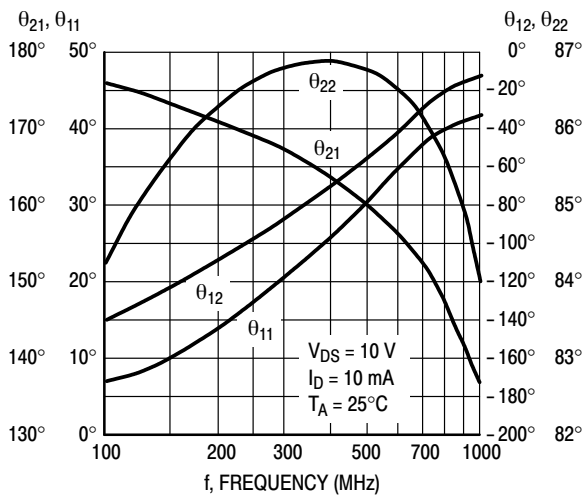

Figure 6. Common-Gate Y Parameter Phase-Angle versus Frequency

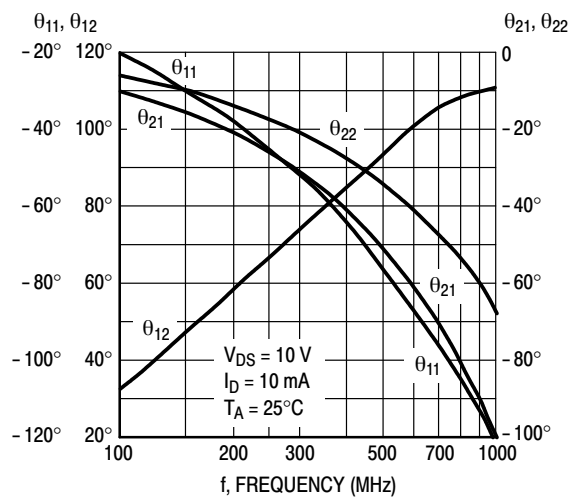
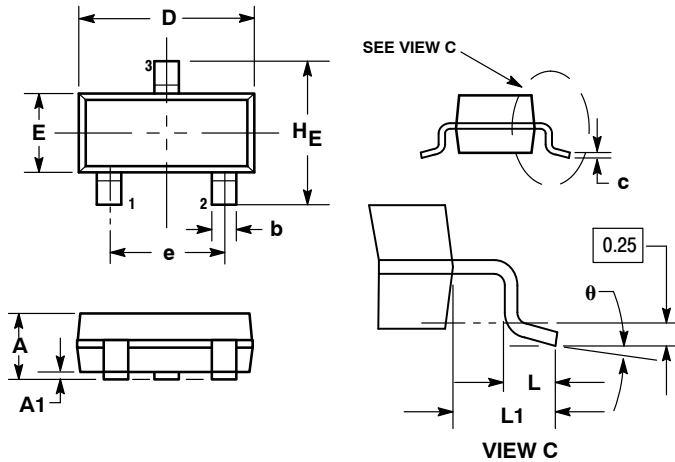

Figure 7. S Parameter Phase-Angle versus Frequency

MMBFJ309L, MMBFJ310L, SMMBFJ310L

PACKAGE DIMENSIONS

SOT-23 (TO-236)
CASE 318-08
ISSUE AP



- NOTES:
1. DIMENSIONING AND TOLERANCING PER ANSI Y14.5M, 1982.
 2. CONTROLLING DIMENSION: INCH.
 3. MAXIMUM LEAD THICKNESS INCLUDES LEAD FINISH THICKNESS. MINIMUM LEAD THICKNESS IS THE MINIMUM THICKNESS OF BASE MATERIAL.
 4. DIMENSIONS D AND E DO NOT INCLUDE MOLD FLASH, PROTRUSIONS, OR GATE BURRS.

DIM	MILLIMETERS			INCHES		
	MIN	NOM	MAX	MIN	NOM	MAX
A	0.89	1.00	1.11	0.035	0.040	0.044
A1	0.01	0.06	0.10	0.001	0.002	0.004
b	0.37	0.44	0.50	0.015	0.018	0.020
c	0.09	0.13	0.18	0.003	0.005	0.007
D	2.80	2.90	3.04	0.110	0.114	0.120
E	1.20	1.30	1.40	0.047	0.051	0.055
e	1.78	1.90	2.04	0.070	0.075	0.081
L	0.10	0.20	0.30	0.004	0.008	0.012
L1	0.35	0.54	0.69	0.014	0.021	0.029
HE	2.10	2.40	2.64	0.083	0.094	0.104
θ	0°	---	10°	0°	---	10°

STYLE 10:
PIN 1. DRAIN
2. SOURCE
3. GATE

SOLDERING FOOTPRINT*

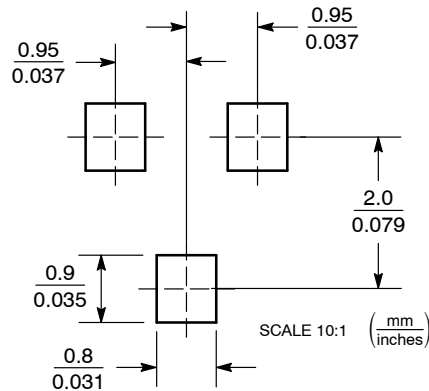

*For additional information on our Pb-Free strategy and soldering details, please download the ON Semiconductor Soldering and Mounting Techniques Reference Manual, SOLDERRM/D.

ON Semiconductor and are registered trademarks of Semiconductor Components Industries, LLC (SCILLC). SCILLC reserves the right to make changes without further notice to any products herein. SCILLC makes no warranty, representation or guarantee regarding the suitability of its products for any particular purpose, nor does SCILLC assume any liability arising out of the application or use of any product or circuit, and specifically disclaims any and all liability, including without limitation special, consequential or incidental damages. "Typical" parameters which may be provided in SCILLC data sheets and/or specifications can and do vary in different applications and actual performance may vary over time. All operating parameters, including "Typicals" must be validated for each customer application by customer's technical experts. SCILLC does not convey any license under its patent rights nor the rights of others. SCILLC products are not designed, intended, or authorized for use as components in systems intended for surgical implant into the body, or other applications intended to support or sustain life, or for any other application in which the failure of the SCILLC product could create a situation where personal injury or death may occur. Should Buyer purchase or use SCILLC products for any such unintended or unauthorized application, Buyer shall indemnify and hold SCILLC and its officers, employees, subsidiaries, affiliates, and distributors harmless against all claims, costs, damages, and expenses, and reasonable attorney fees arising out of, directly or indirectly, any claim of personal injury or death associated with such unintended or unauthorized use, even if such claim alleges that SCILLC was negligent regarding the design or manufacture of the part. SCILLC is an Equal Opportunity/Affirmative Action Employer. This literature is subject to all applicable copyright laws and is not for resale in any manner.

PUBLICATION ORDERING INFORMATION

LITERATURE FULFILLMENT:
Literature Distribution Center for ON Semiconductor
P.O. Box 5163, Denver, Colorado 80217 USA
Phone: 303-675-2175 or 800-344-3860 Toll Free USA/Canada
Fax: 303-675-2176 or 800-344-3867 Toll Free USA/Canada
Email: orderlit@onsemi.com

N. American Technical Support: 800-282-9855 Toll Free
USA/Canada
Europe, Middle East and Africa Technical Support:
Phone: 421 33 790 2910
Japan Customer Focus Center
Phone: 81-3-5817-1050

ON Semiconductor Website: www.onsemi.com
Order Literature: <http://www.onsemi.com/orderlit>
For additional information, please contact your local Sales Representative

Компания «Life Electronics» занимается поставками электронных компонентов импортного и отечественного производства от производителей и со складов крупных дистрибьюторов Европы, Америки и Азии.

С конца 2013 года компания активно расширяет линейку поставок компонентов по направлению коаксиальный кабель, кварцевые генераторы и конденсаторы (керамические, пленочные, электролитические), за счёт заключения дистрибьюторских договоров

Мы предлагаем:

- Конкуренспособные цены и скидки постоянным клиентам.
- Специальные условия для постоянных клиентов.
- Подбор аналогов.
- Поставку компонентов в любых объемах, удовлетворяющих вашим потребностям.
- Приемлемые сроки поставки, возможна ускоренная поставка.
- Доставку товара в любую точку России и стран СНГ.
- Комплексную поставку.
- Работу по проектам и поставку образцов.
- Формирование склада под заказчика.
- Сертификаты соответствия на поставляемую продукцию (по желанию клиента).
- Тестирование поставляемой продукции.
- Поставку компонентов, требующих военную и космическую приемку.
- Входной контроль качества.
- Наличие сертификата ISO.

В составе нашей компании организован Конструкторский отдел, призванный помогать разработчикам, и инженерам.

Конструкторский отдел помогает осуществить:

- Регистрацию проекта у производителя компонентов.
- Техническую поддержку проекта.
- Защиту от снятия компонента с производства.
- Оценку стоимости проекта по компонентам.
- Изготовление тестовой платы монтаж и пусконаладочные работы.



Тел: +7 (812) 336 43 04 (многоканальный)

Email: org@lifeelectronics.ru