

RONDA-WW

~60° wide beam with holder A compatible with 3rd party connectors from TE, Bender+Wirth and IDEAL

TECHNICAL SPECIFICATIONS:

Dimensions	Ø 69.9 mm
Height	14.6 mm
Fastening	socket
ROHS compliant	yes ⓘ

MATERIAL SPECIFICATIONS:

Component	Type	Material	Colour	Finish
RONDA-WW	Single lens	PMMA	clear	
RONDA-HLD-A	Holder	PC	white	

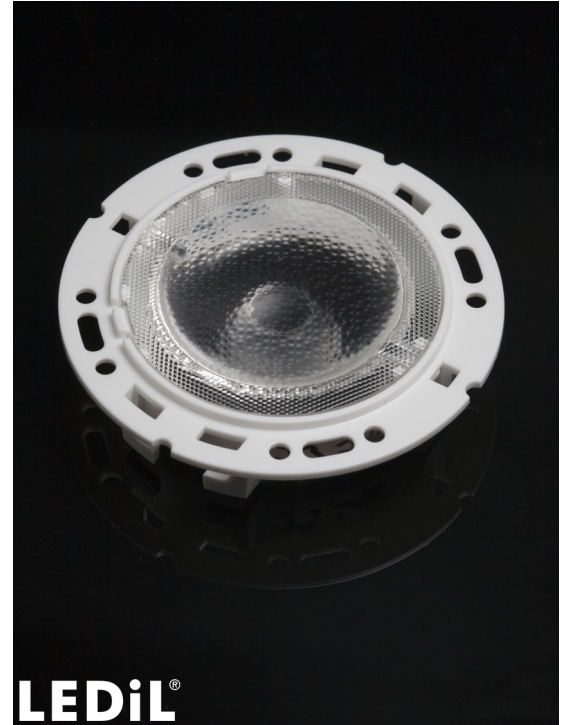



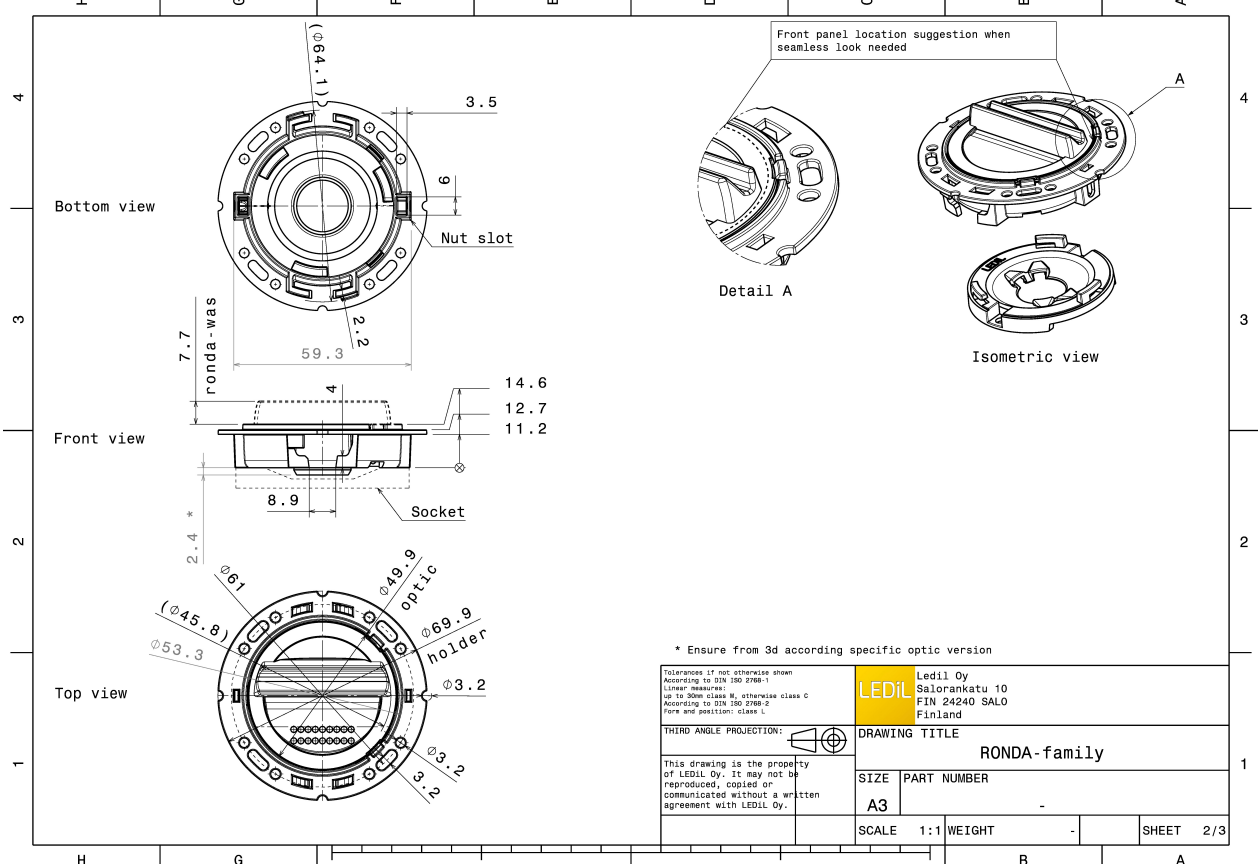
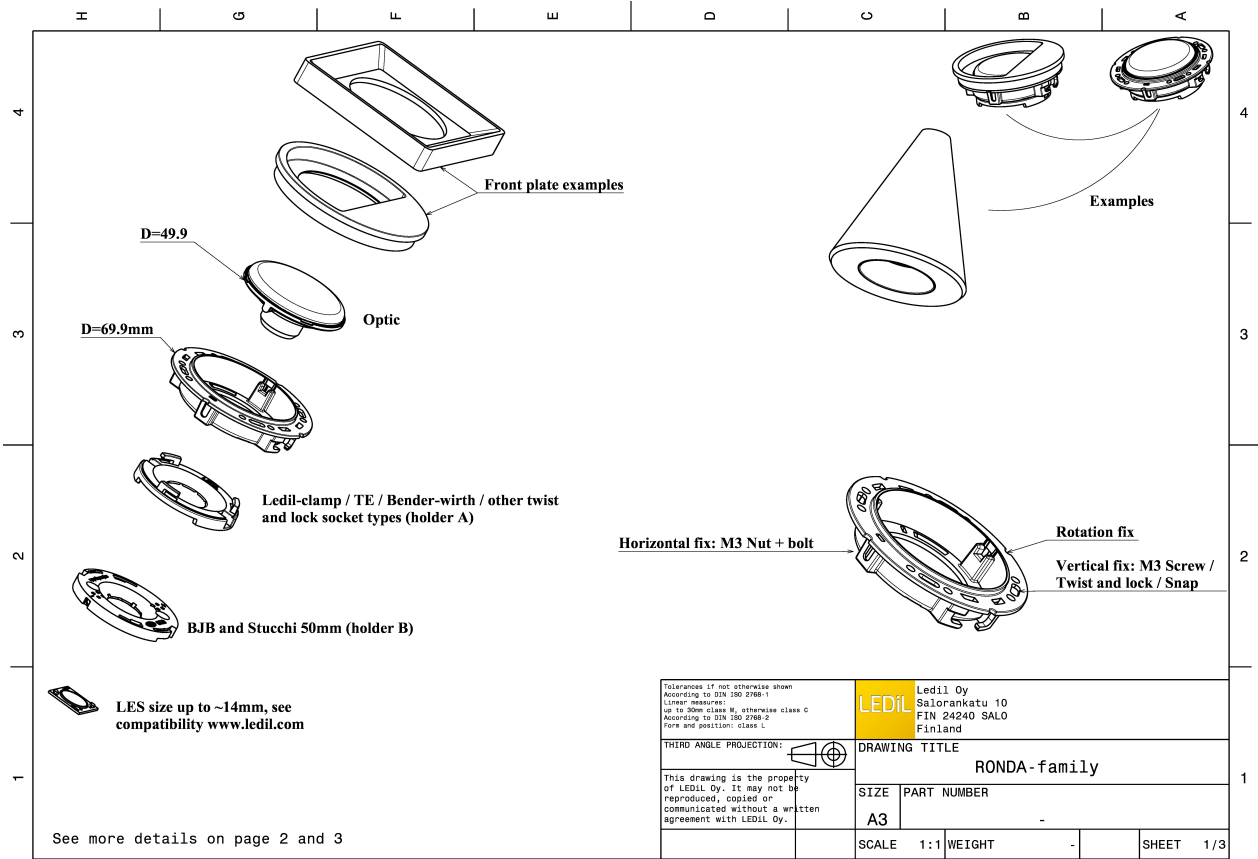

ORDERING INFORMATION:

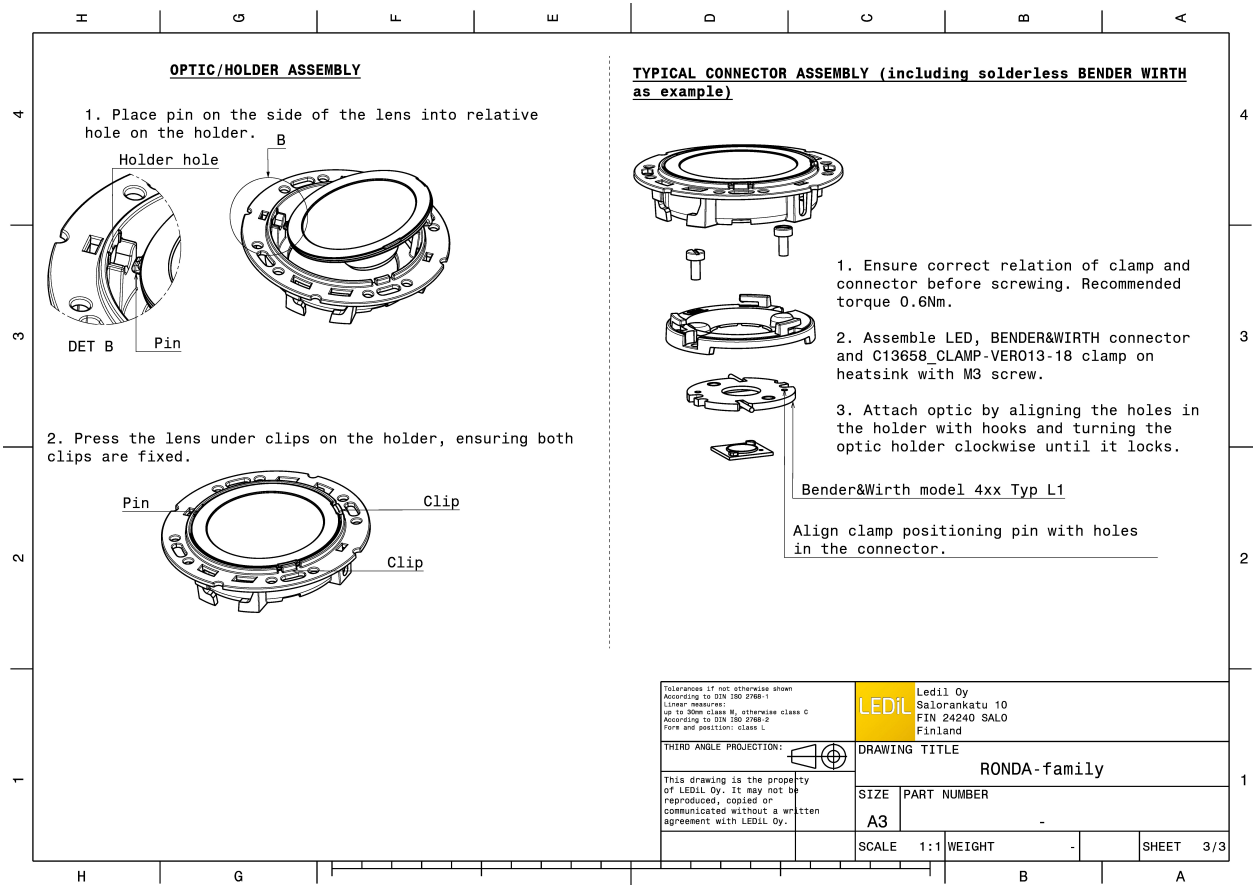
Component		Qty in box	MOQ	MPQ	Box weight (kg)
FN15387_RONDA-WW	Single lens	420	120	30	0.0
» Box size:					



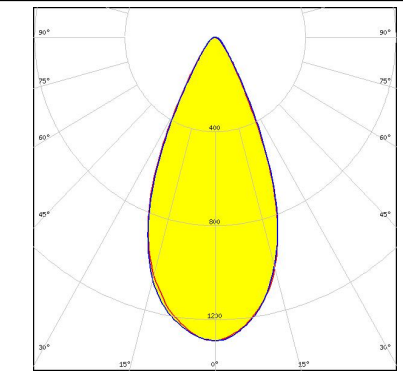

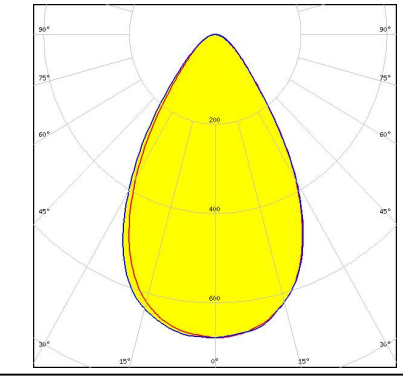
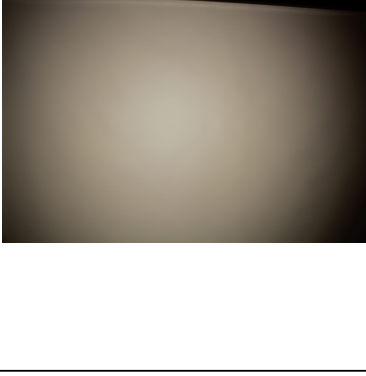
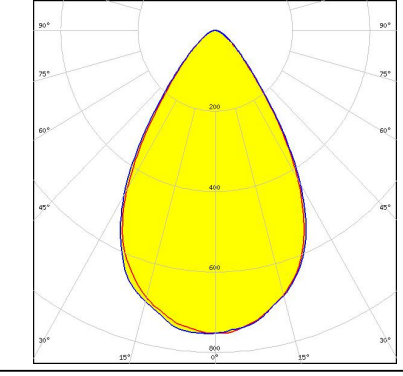
PHOTOMETRIC DATA (MEASURED):

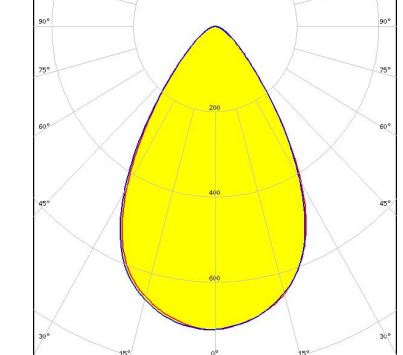
<p>bridgelux.</p> <p>LED V10 Gen7 FWHM 47.0° Efficiency % LEDs/each optic 1 Light colour White Required components: C13658_CLAMP-VERO13-18 Bender Wirth: 486 Typ L1</p>		
<p>bridgelux.</p> <p>LED V13 Gen7 FWHM 64.0° Efficiency 82 % Peak intensity 0.7 cd/lm LEDs/each optic 1 Light colour White Required components: TE: 2213254-2 + OPTIC CLIP Z50 TYPE1 2213194-1</p>		
<p>bridgelux.</p> <p>LED Vero SE 13 FWHM 65.0° Efficiency 90 % Peak intensity 0.8 cd/lm LEDs/each optic 1 Light colour White Required components: C16402_CLAMP-VEROSE-13-18</p>		
<p>bridgelux.</p> <p>LED VERO13 FWHM 66.0° Efficiency 88 % Peak intensity 0.7 cd/lm LEDs/each optic 1 Light colour White Required components: C13658_CLAMP-VERO13-18</p>		

PHOTOMETRIC DATA (MEASURED):

CITIZEN

LED CLL03x/CLU03x
 FWHM 59.0°
 Efficiency 81 %
 Peak intensity 0.7 cd/lm
 LEDs/each optic 1
 Light colour White
 Required components:
 IDEAL: 50-2103CT + 50-2100AN

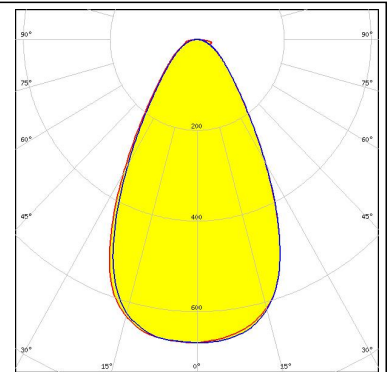
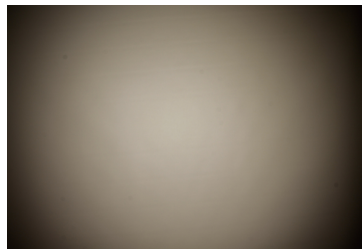

CITIZEN

LED CLL03x/CLU03x
 FWHM 63.0°
 Efficiency 87 %
 Peak intensity 0.7 cd/lm
 LEDs/each optic 1
 Light colour White
 Required components:
 C16791_CLAMP-Z45-A
 TE: 2325807-3

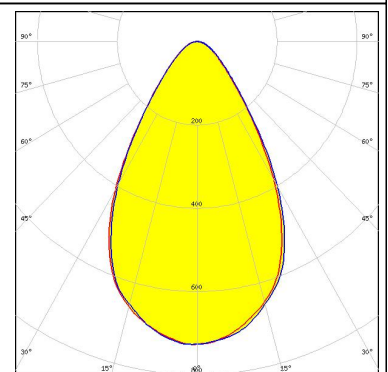
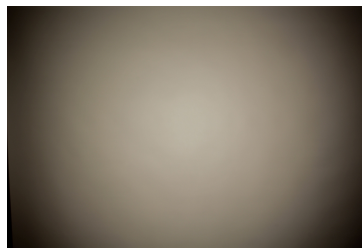

CITIZEN

LED CLL04x/CLU04x
 FWHM 66.0°
 Efficiency 81 %
 Peak intensity 0.5 cd/lm
 LEDs/each optic 1
 Light colour White
 Required components:
 IDEAL: 50-2204-CT + 50-2100AN

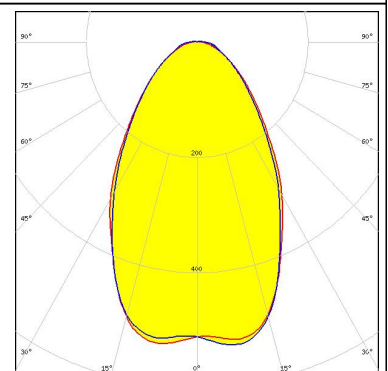
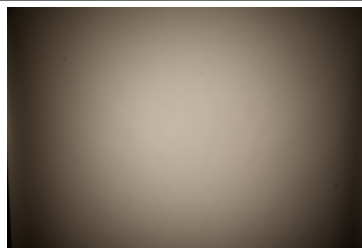

CITIZEN

LED CLU730/731
 FWHM 58.0°
 Efficiency 83 %
 Peak intensity 0.7 cd/lm
 LEDs/each optic 1
 Light colour White
 Required components:
 IDEAL: 50-2204-CT + 50-2100AN

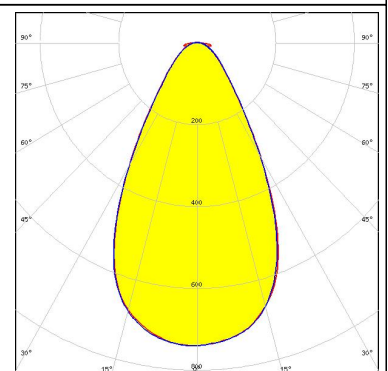
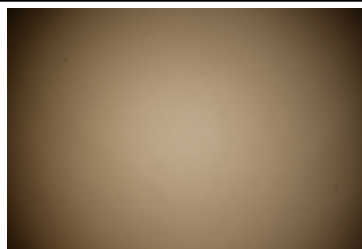

PHOTOMETRIC DATA (MEASURED):



LED CMA1840
 FWHM 69.0°
 Efficiency 89 %
 Peak intensity 0.7 cd/lm
 LEDs/each optic 1
 Light colour White
 Required components:
 C14123_CLAMP-CXA15-18

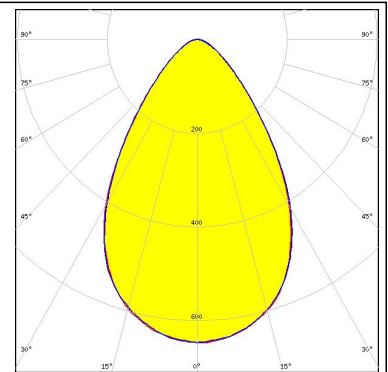

LED CXA/B 1816 & CXA/B 1820 & CXA 1850
 FWHM 66.0°
 Efficiency 93 %
 Peak intensity 0.8 cd/lm
 LEDs/each optic 1
 Light colour White
 Required components:
 C14123_CLAMP-CXA15-18

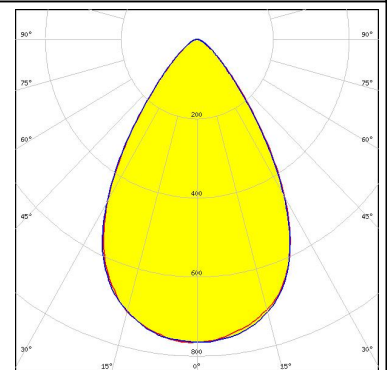
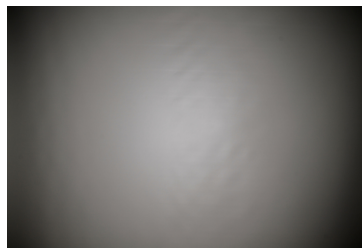

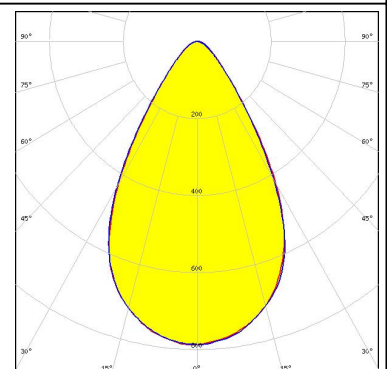
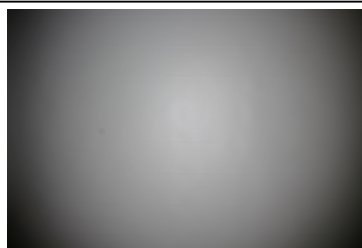

LED CXA/B 1816 & CXA/B 1820 & CXA 1850
 FWHM 62.0°
 Efficiency 88 %
 Peak intensity 0.8 cd/lm
 LEDs/each optic 1
 Light colour White
 Required components:
 TE: 2213401-2 + OPTIC CLIP Z50 TYPE1 2213194-1

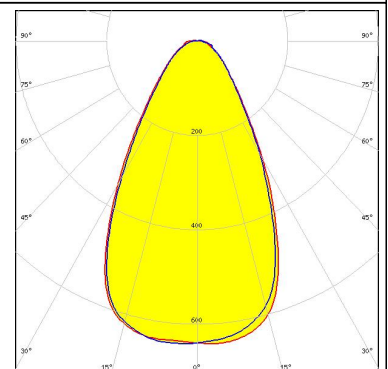
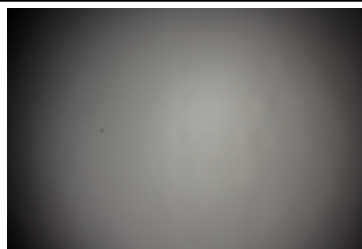

LED COB J-Type
 FWHM 60.0°
 Efficiency 81 %
 Peak intensity 0.6 cd/lm
 LEDs/each optic 1
 Light colour White
 Required components:
 IDEAL: 50-2103NC + 50-2100AN

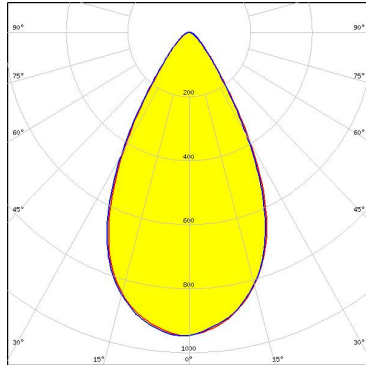
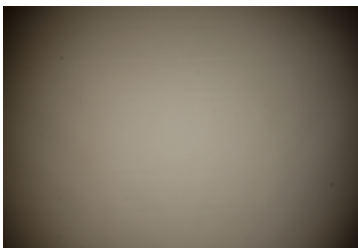
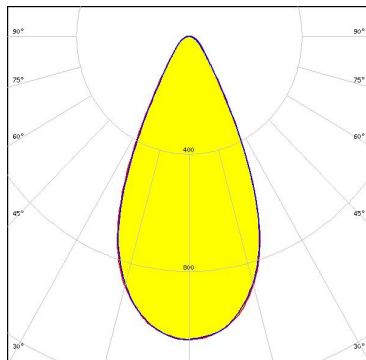

PHOTOMETRIC DATA (MEASURED):

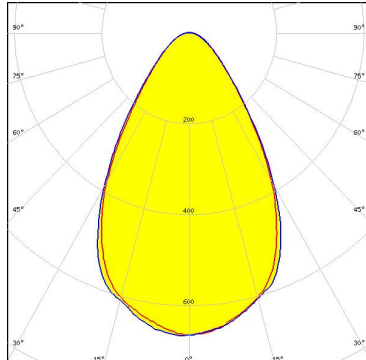
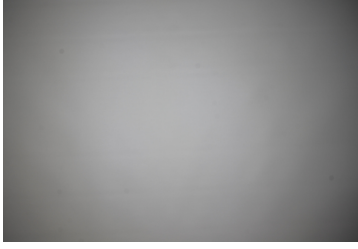
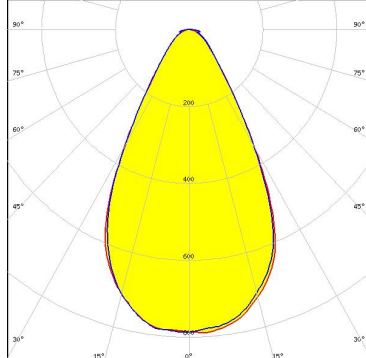
<p>NICHIA</p> <p>LED COB L-Type (LES 11)</p> <p>FWHM 57.0°</p> <p>Efficiency 88 %</p> <p>Peak intensity 1 cd/lm</p> <p>LEDs/each optic 1</p> <p>Light colour White</p> <p>Required components: TE: 2213382-2 + OPTIC CLIP Z50 TYPE1 2213194-1</p>		
<p>NICHIA</p> <p>LED COB L-Type (LES 11)</p> <p>FWHM 50.0°</p> <p>Efficiency 85 %</p> <p>Peak intensity 1 cd/lm</p> <p>LEDs/each optic 1</p> <p>Light colour White</p> <p>Required components: IDEAL: 50-2100NC + 50-2100AN</p>		
<p>OSRAM</p> <p>LED PrevaLED Core G7 L15 H1</p> <p>FWHM 65.0°</p> <p>Efficiency 86 %</p> <p>Peak intensity 0.7 cd/lm</p> <p>LEDs/each optic 1</p> <p>Light colour White</p> <p>Required components: C16685_CLAMP-PRV-A</p>		
<p>OSRAM Opto Semiconductors</p> <p>LED Soleriq S13 19x19</p> <p>FWHM 58.0°</p> <p>Efficiency 85 %</p> <p>Peak intensity 0.8 cd/lm</p> <p>LEDs/each optic 1</p> <p>Light colour White</p> <p>Required components: IDEAL: 50-2103CT + 50-2100AN</p>		

PHOTOMETRIC DATA (MEASURED):

OSRAM

Opto Semiconductors

LED Soleriq S13 19x19
 FWHM 63.0°
 Efficiency 84 %
 Peak intensity 0.7 cd/lm
 LEDs/each optic 1
 Light colour White

Required components:

TE: 2213254-2 + OPTIC CLIP Z50 TYPE1 2213194-1

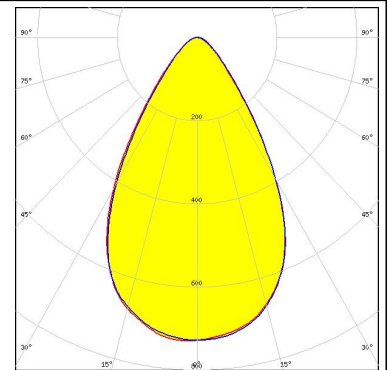

PHILIPS

LED Fortimo SLM L13 + SLM holder
 FWHM 61.0°
 Efficiency 82 %
 Peak intensity 0.7 cd/lm
 LEDs/each optic 1
 Light colour White

Required components:

TE: OPTIC CLIP Z50 TYPE1 2213194-1

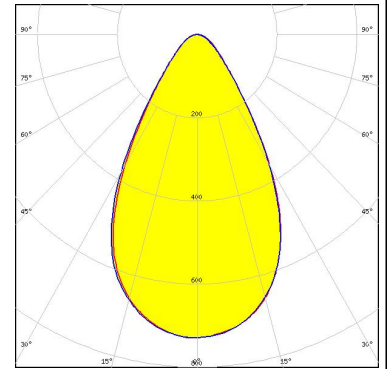

PHILIPS

LED Fortimo SLM L13 CoB
 FWHM 66.0 + °
 Efficiency 85 %
 Peak intensity 0.7 cd/lm
 LEDs/each optic 1
 Light colour White

Required components:

TE: 2213130-2 + OPTIC CLIP Z50 TYPE1 2213194-1

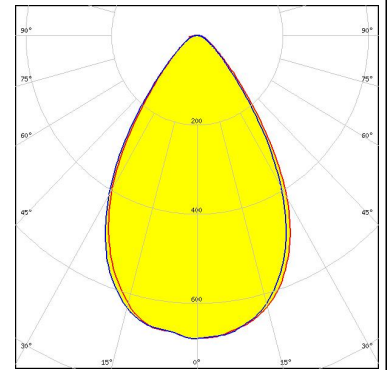

PHILIPS

LED Fortimo SLM L15 + SLM holder
 FWHM 66.0°
 Efficiency 83 %
 Peak intensity 0.6 cd/lm
 LEDs/each optic 1
 Light colour White

Required components:

TE: OPTIC CLIP Z50 TYPE1 2213194-1

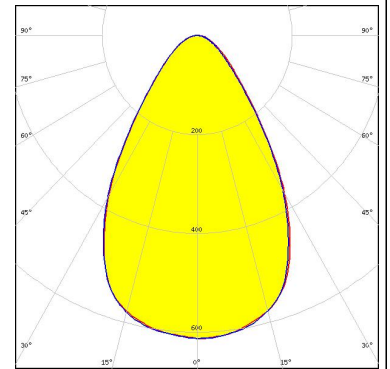
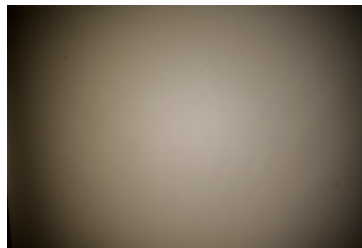

PHOTOMETRIC DATA (MEASURED):

SAMSUNG

LED LC040C
 FWHM 60.0°
 Efficiency 86 %
 Peak intensity 0.8 cd/lm
 LEDs/each optic 1
 Light colour White

Required components:
 TE: 2213382-2 + OPTIC CLIP Z50 TYPE1 2213194-1

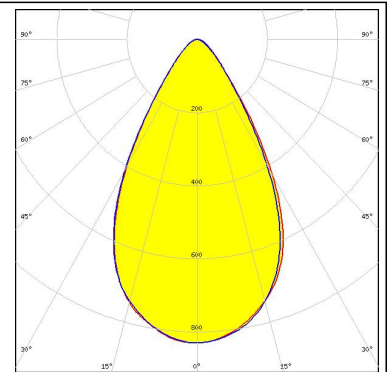

SEOUL SEMICONDUCTOR
 LED AC Zhaga COB
 FWHM 67.0°
 Efficiency 84 %
 Peak intensity 0.6 cd/lm
 LEDs/each optic 1
 Light colour White

Required components:
 Optosource: SEHSMJD-A

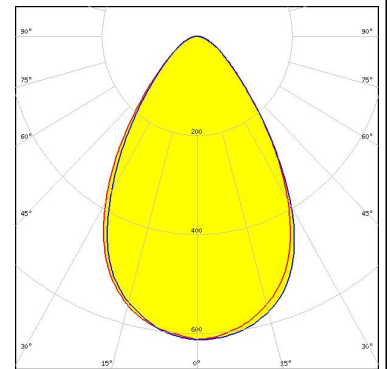
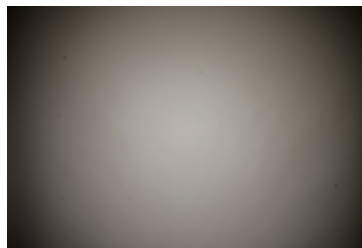

SEOUL SEMICONDUCTOR
 LED MJT COB LES 14.5
 FWHM 69.0°
 Efficiency 80 %
 Peak intensity 0.6 cd/lm
 LEDs/each optic 1
 Light colour White

Required components:
 TE: 2213254-2 + OPTIC CLIP Z50 TYPE1 2213194-1

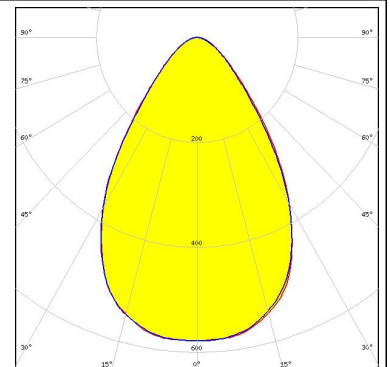
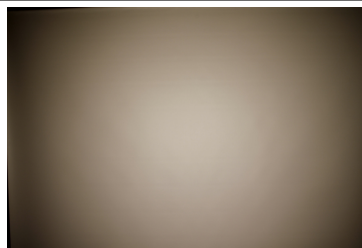

VS LIGHTING SOLUTIONS
 LED WU-M-484
 FWHM 69.0°
 Efficiency 83 %
 Peak intensity 0.6 cd/lm
 LEDs/each optic 1
 Light colour White

Required components:
 TE: OPTIC CLIP Z50 TYPE1 2213194-1

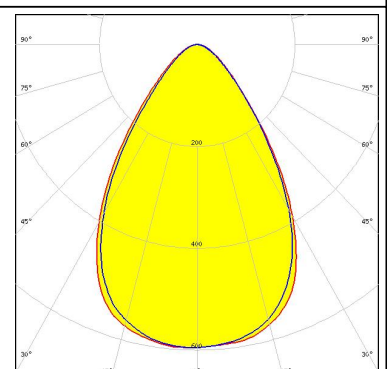
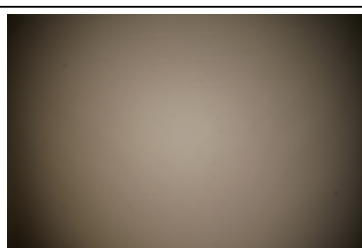

PHOTOMETRIC DATA (SIMULATED):

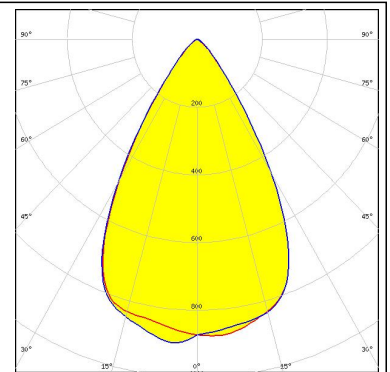
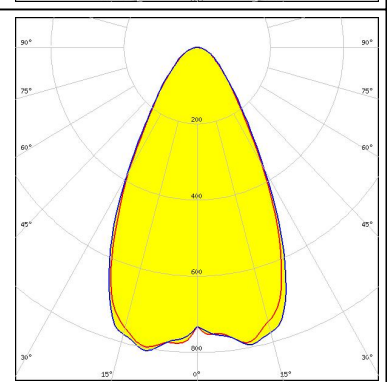
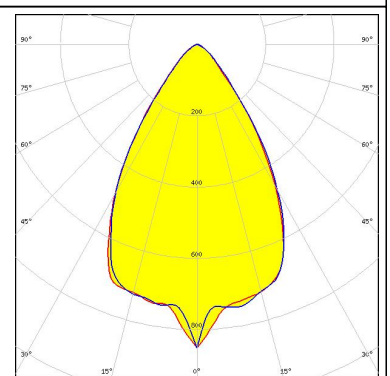
<p>bridgelux.</p> <p>LED V10 Gen6 FWHM 60.0° Efficiency 88 % LEDs/each optic 1 Light colour White Required components: C14123_CLAMP-CXA15-18</p>	
<p>bridgelux.</p> <p>LED V13 Gen7 FWHM 59.0° Efficiency 89 % Peak intensity 0.8 cd/lm LEDs/each optic 1 Light colour White Required components: IDEAL: 50-2103CT + 50-2100AN</p>	
<p>bridgelux.</p> <p>LED V13 Gen7 FWHM 60.0° Efficiency 88 % Peak intensity 0.9 cd/lm LEDs/each optic 1 Light colour White Required components: C13658_CLAMP-VERO13-18 Bender Wirth: 477 Typ L1</p>	

CITIZEN

LED	CLL02x/CLU02x (LES10)
FWHM	60.0°
Efficiency	88 %
LEDs/each optic	1
Light colour	White
Required components:	
	C13658_CLAMP-VERO13-18
	Bender Wirth: 434 Typ L1

PHOTOMETRIC DATA (SIMULATED):

CITIZEN

LED CLU700/701/702
FWHM 60.0°
Efficiency 89 %
LEDs/each optic 1
Light colour White
Required components:
C13658_CLAMP-VERO13-18
Bender Wirth: 434 Typ L1

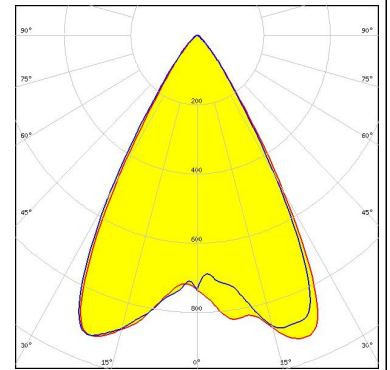

CITIZEN

LED CLU710/711
FWHM 60.0°
Efficiency 88 %
LEDs/each optic 1
Light colour White
Required components:
C13658_CLAMP-VERO13-18
Bender Wirth: 470 Typ L1

CREE

LED CXA/B 13xx
FWHM 62.0°
Efficiency 89 %
LEDs/each optic 1
Light colour White
Required components:
C13658_CLAMP-VERO13-18
Bender Wirth: 448 Typ L1

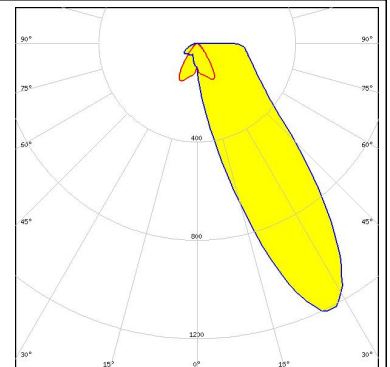

CREE

LED CXA/B 15xx
FWHM 62.0°
Efficiency 89 %
LEDs/each optic 1
Light colour White
Required components:
C13658_CLAMP-VERO13-18
Bender Wirth: 441 Typ L1

PHOTOMETRIC DATA (SIMULATED):

CREE

LED CXA/B 15xx
FWHM 62.0°
Efficiency 89 %
LEDs/each optic 1
Light colour White
Required components:
C14123_CLAMP-CXA15-18

CREE

LED CXA/B 1816 & CXA/B 1820 & CXA 1850
FWHM 63.0°
Efficiency 89 %
LEDs/each optic 1
Light colour White
Required components:
C14123_CLAMP-CXA15-18

CREE

LED CXA/B 1816 & CXA/B 1820 & CXA 1850
FWHM 57.0°
Efficiency 85 %
LEDs/each optic 1
Light colour White
Required components:
TE: 2213401-2 + OPTIC CLIP Z50 TYPE1 2213194-1

CREE

LED CXA/B 1816 & CXA/B 1820 & CXA 1850
FWHM 63.0°
Efficiency 89 %
LEDs/each optic 1
Light colour White
Required components:
C13658_CLAMP-VERO13-18
Bender Wirth: 437 Typ L1

PHOTOMETRIC DATA (SIMULATED):



LED CXA/B 1830
FWHM 62.0°
Efficiency 87 %
LEDs/each optic 1
Light colour White
Required components:
C14123_CLAMP-CXA15-18



LED LUXEON CoB 1202/1203
FWHM 56.0°
Efficiency 87 %
Peak intensity 1 cd/lm
LEDs/each optic 1
Light colour White
Required components:
TE: 2213382-2 + OPTIC CLIP Z50 TYPE1 2213194-1

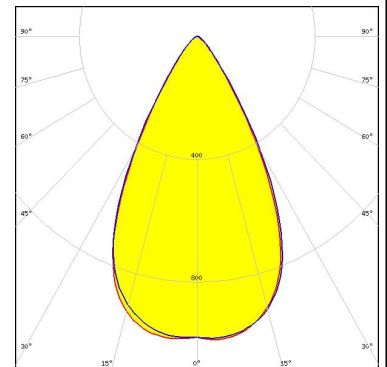

LED LUXEON CoB 1202s
FWHM 60.0°
Efficiency 89 %
LEDs/each optic 1
Light colour White
Required components:
C13658_CLAMP-VERO13-18
Bender Wirth: 452 Typ L1

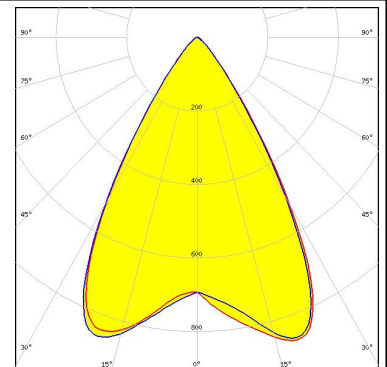

LED COB L-Type (LES 9)
FWHM 56.0°
Efficiency 87 %
Peak intensity 1 cd/lm
LEDs/each optic 1
Light colour White
Required components:
TE: 2213382-2 + OPTIC CLIP Z50 TYPE1 2213194-1

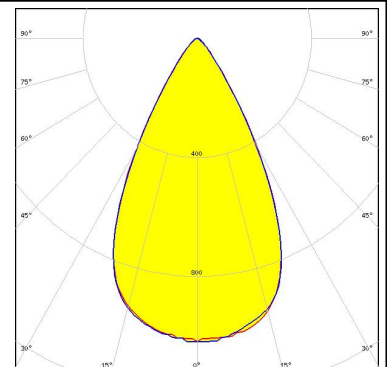

PHOTOMETRIC DATA (SIMULATED):



LED NSCxL036A
FWHM 56.0°
Efficiency 88 %
Peak intensity 1 cd/lm
LEDs/each optic 1
Light colour White
Required components:
TE: 2213382-2 + OPTIC CLIP Z50 TYPE1 2213194-1



LED Duris S10
FWHM 66.0°
Efficiency 89 %
LEDs/each optic 1
Light colour White
Required components:
C13658_CLAMP-VERO13-18



LED Soleriq S13
FWHM 63.0°
Efficiency 84 %
LEDs/each optic 1
Light colour White
Required components:
C14123_CLAMP-CXA15-18

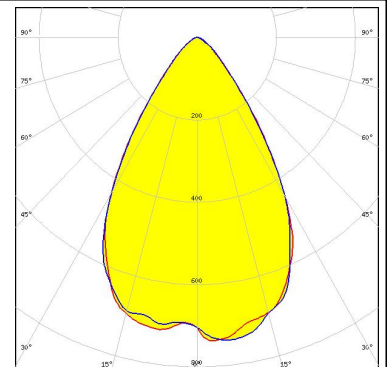

LED Mini Zenigata (GW6BM)
FWHM 62.0°
Efficiency 88 %
LEDs/each optic 1
Light colour White
Required components:
C13658_CLAMP-VERO13-18
Bender Wirth: 452 Typ L1

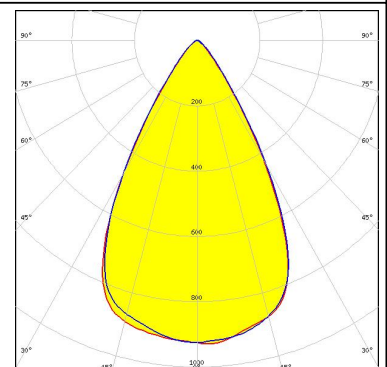

GENERAL INFORMATION:

NOTE: The typical beam angle will be changed by different color, chip size and chip position tolerance. The typical total beam angle is the full angle measured where the luminous intensity is half of the peak value.

Due to use of high power COB's with this product, special attention to proper thermal design is highly recommended. LEDiL has no liability for direct, indirect or consecutive damages arising from the LEDiL products being used outside of the recommended temperature range.

MATERIALS:

As part of our continuous research and improvement processes, and to ensure the best possible quality and availability of our products, LEDiL reserves the right to change material grades without notice.

PRODUCT DATA USER AGREEMENT AND DISCLAIMER:

The measured data in the provided downloadable LEDiL Product Datasheets and Mechanical 2D-Drawings is rounded and provided as reference for planning. LEDiL Oy's optical specifications have been verified by conducting performance testing of the products in accordance with the company's quality system. The reported data are averaged results of multiple measurements with typical variation. LEDiL Oy reserves the right to without prior notification make changes and improvements to its products.

LEDiL Oy assumes neither warranty, nor guarantee nor any other liability of any kind for the contents and correctness of the provided data. The provided data has been generated with highest diligence but the provided data may in reality not represent the complete possible variation range of all intrinsic parameters. Therefore, in certain cases a deviation from the provided data could occur.

LEDiL Oy reserves the right to undertake technical changes of its products without further notification which could lead to changes in the provided data. LEDiL Oy assumes no liability of any kind for the possible deviation from any provided data or any other damage resulting from the usage of the provided data.

The user agrees to this disclaimer and user agreement with the download or usage of the provided files.

LEDiL Oy

Joensuunkatu 13
FI-24240 SALO
Finland

LEDiL Inc.

228 West Page Street
Suite D
Sycamore IL 60178
USA

Local sales and technical support

www.ledil.com/where_to_buy

Shipping locations

Salo, Finland
Hong Kong, China

Distribution Partners

www.ledil.com/where_to_buy

Компания «Life Electronics» занимается поставками электронных компонентов импортного и отечественного производства от производителей и со складов крупных дистрибьюторов Европы, Америки и Азии.

С конца 2013 года компания активно расширяет линейку поставок компонентов по направлению коаксиальный кабель, кварцевые генераторы и конденсаторы (керамические, пленочные, электролитические), за счёт заключения дистрибьюторских договоров

Мы предлагаем:

- Конкурентоспособные цены и скидки постоянным клиентам.
- Специальные условия для постоянных клиентов.
- Подбор аналогов.
- Поставку компонентов в любых объемах, удовлетворяющих вашим потребностям.
- Приемлемые сроки поставки, возможна ускоренная поставка.
- Доставку товара в любую точку России и стран СНГ.
- Комплексную поставку.
- Работу по проектам и поставку образцов.
- Формирование склада под заказчика.
- Сертификаты соответствия на поставляемую продукцию (по желанию клиента).
- Тестирование поставляемой продукции.
- Поставку компонентов, требующих военную и космическую приемку.
- Входной контроль качества.
- Наличие сертификата ISO.

В составе нашей компании организован Конструкторский отдел, призванный помогать разработчикам, и инженерам.

Конструкторский отдел помогает осуществить:

- Регистрацию проекта у производителя компонентов.
- Техническую поддержку проекта.
- Защиту от снятия компонента с производства.
- Оценку стоимости проекта по компонентам.
- Изготовление тестовой платы монтаж и пусконаладочные работы.



Тел: +7 (812) 336 43 04 (многоканальный)

Email: org@lifeelectronics.ru