

FEATURES

- Highly accurate; supports EN 50470-1, EN 50470-3, IEC 62053-21, IEC 62053-22, and IEC 62053-23 standards**
- Compatible with 3-phase, 3- or 4-wire (delta or wye) meters, and other 3-phase services**
- Supplies total (fundamental and harmonic) active, reactive, and apparent energy and fundamental active/reactive energy on each phase and on the overall system**
- 0.1% error (typical) in active and reactive energy over a dynamic range of 1000 to 1 at T_A = 25°C**
- 0.2% error (typical) in active and reactive energy over a dynamic range of 3000 to 1 at T_A = 25°C**
- Averaged rms measurements available in low ripple rms registers**
- Supports current transformer and di/dt current sensors**
- Dedicated ADC channel for neutral current input**
- Estimated neutral current measurement by calculating the rms of the sum of the phase currents in all 3 phases**
- 0.1% error (typical) in voltage and current rms over a dynamic range of 1000 to 1 at T_A = 25°C**
- Supplies sampled waveform data on all 3 phases and on neutral current**
- Selectable no load thresholds for total and fundamental active and reactive powers, as well as for apparent powers**
- Highly accurate low power battery mode phase current monitoring for antitampering detection**
- Battery supply input for missing neutral operation**
- Phase angle measurements in current and voltage channels**
- Calibration frequency (CF) output directly drives LED and opto-isolators**
- Reference: 1.2 V (drift of ±5 ppm/°C typical) with external overdrive capability**
- Single 3.3 V supply**
- 40-lead, Pb-free lead frame chip scale package (LFCSP)**
- Operating temperature: -40°C to +85°C**
- Flexible I²C, SPI, and HSDC serial interfaces**

GENERAL DESCRIPTION

The ADE7854A/ADE7858A/ADE7868A/ADE7878A are high accuracy, 3-phase electrical energy measurement ICs with serial interfaces and three flexible pulse outputs. The devices incorporate second-order Σ - Δ analog-to-digital converters (ADCs), a digital integrator, reference circuitry, and all signal processing required to perform total (fundamental and harmonic) active, reactive (ADE7858A, ADE7868A, and ADE7878A), and apparent energy measurement and rms calculations.

The ADE7878A can also perform fundamental-only active and reactive energy measurement and rms calculations. A fixed function digital signal processor (DSP) executes the signal processing. The DSP program is stored in the internal ROM memory.

The ADE7854A/ADE7858A/ADE7868A/ADE7878A can measure active, reactive, and apparent energy in various 3-phase configurations, such as wye or delta services, with both three and four wires. Aside from regular rms measurements, which are updated every 8 kHz, these devices measure low ripple rms values, which are averaged internally and updated every 1.024 sec. The devices provide system calibration features for each phase, that is, rms offset correction, phase calibration, and gain calibration.

The CF1, CF2, and CF3 logic outputs provide a wide selection of power information. All four devices provide total active and apparent powers, as well as the sum of the current rms values; the ADE7858A, ADE7868A, and ADE7878A also provide total reactive powers; whereas the ADE7878A provides fundamental active and reactive powers.

The ADE7854A/ADE7858A/ADE7868A/ADE7878A contain waveform sampling registers that allow access to all ADC outputs. The devices also incorporate power quality measurements, such as short duration low or high voltage detection, short duration high current variation, line voltage period measurement, and angles between phase voltages and currents.

Two serial interfaces, serial peripheral interface (SPI) and I²C, can communicate with the devices. A dedicated high speed interface, the high speed data capture (HSDC) port, can be used in conjunction with I²C to provide access to the ADC outputs and real-time power information.

The devices have two interrupt request pins, $\overline{\text{IRQ0}}$ and $\overline{\text{IRQ1}}$, to indicate that an enabled interrupt event has occurred. For the ADE7868A/ADE7878A, three specially designed low power modes ensure the continuity of energy accumulation when the ADE7868A/ADE7878A are in a tampering situation.

Table 1 lists each device and its functions. These devices are available in 40-lead, Pb-free LFCSP packages.

Table 1. Device Comparison

Part No.	WATT	VAR	I RMS, V RMS, and VA	di/dt	Fundamental WATT and VAR	Tamper Detect and Low Power Modes
ADE7854A	Yes	No	Yes	Yes	No	No
ADE7858A	Yes	Yes	Yes	Yes	No	No
ADE7868A	Yes	Yes	Yes	Yes	No	Yes
ADE7878A	Yes	Yes	Yes	Yes	Yes	Yes

TABLE OF CONTENTS

Features	1	Reference Circuit.....	41
General Description	1	Digital Signal Processor.....	42
Revision History	2	Root Mean Square Measurement.....	43
Functional Block Diagrams.....	3	Active Power Calculation.....	47
Specifications.....	7	Reactive Power Calculation—ADE7858A, ADE7868A, ADE7878A Only.....	53
Timing Characteristics	10	Apparent Power Calculation.....	57
Absolute Maximum Ratings.....	13	Waveform Sampling Mode	60
Thermal Resistance	13	Energy to Frequency Conversion.....	60
ESD Caution.....	13	No Load Condition	64
Pin Configuration and Function Descriptions.....	14	Checksum Register.....	65
Typical Performance Characteristics	16	Interrupts.....	66
Test Circuit	19	Applications Information.....	68
Terminology	20	Quick Setup of Devices as Energy Meters	68
Power Management.....	21	Crystal Circuit	68
PSM0 Normal Power Mode (All Devices).....	21	Layout Guidelines.....	69
PSM1 Reduced Power Mode (ADE7868A and ADE7878A Only)	21	ADE7878A Evaluation Board.....	69
PSM2 Low Power Mode (ADE7868A and ADE7878A Only)	21	Die Version.....	69
PSM3 Sleep Mode (All Devices).....	23	Silicon Anomaly	70
Power-Up Procedure.....	25	ADE7854A/ADE7858A/ADE7868A/ADE7878A Functionality Issues.....	70
Hardware Reset.....	25	Functionality Issues.....	70
Software Reset.....	26	Serial Interfaces.....	71
Theory of Operation	27	Serial Interface Selection.....	71
Analog Inputs.....	27	Communication Verification.....	71
Analog-to-Digital Conversion.....	27	I ² C-Compatible Interface	71
Current Channel ADC.....	28	SPI-Compatible Interface.....	73
di/dt Current Sensor and Digital Integrator	30	HSDC Interface	75
Voltage Channel ADC	31	Register List.....	77
Changing the Phase Voltage Datapath	32	Outline Dimensions	95
Power Quality Measurements.....	32	Ordering Guide	95
Phase Compensation.....	40		

REVISION HISTORY

10/14—Rev. A to Rev. B

Changes to Figure 23.....	19
Changes to Figure 27.....	25
Changes to Silicon Anomaly Section.....	70

7/14—Revision A: Initial Version

FUNCTIONAL BLOCK DIAGRAMS

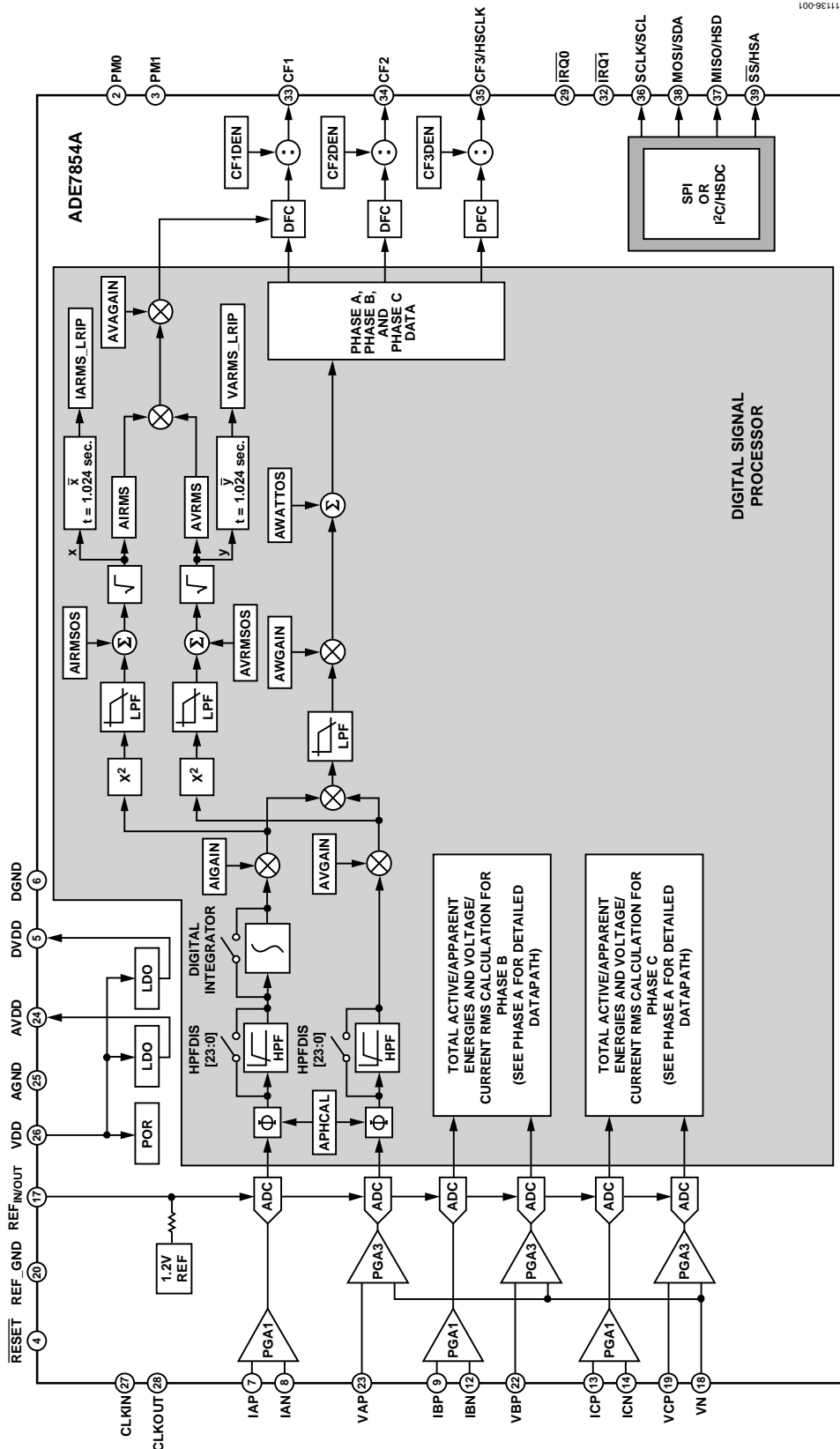

Figure 1. ADE7854A Functional Block Diagram

11136-003



Figure 3. ADE7868A Functional Block Diagram

SPECIFICATIONS

VDD = 3.3 V ± 10%, AGND = DGND = 0 V, on-chip reference, CLKIN = 16.384 MHz, T_{MIN} to T_{MAX} = -40°C to +85°C, T_{TYP} = 25°C, unless otherwise noted.

Table 2.

Parameter ^{1, 2, 3}	Min	Typ	Max	Unit	Test Conditions/Comments
ACTIVE ENERGY MEASUREMENT (PSM0 MODE)					
Active Energy Measurement Error (Per Phase)					
Total Active Energy		0.1		%	Over a dynamic range of 1000 to 1, PGA = 1, 2, 4; integrator off
		0.2		%	Over a dynamic range of 3000 to 1, PGA = 1, 2, 4; integrator off
Fundamental Active Energy		0.1		%	Over a dynamic range of 500 to 1, PGA = 8, 16; integrator on ADE7878A only
		0.1		%	Over a dynamic range of 1000 to 1, PGA = 1, 2, 4; integrator off
		0.2		%	Over a dynamic range of 3000 to 1, PGA = 1, 2, 4; integrator off
		0.1		%	Over a dynamic range of 500 to 1, PGA = 8, 16; integrator on
AC Power Supply Rejection					VDD = 3.3 V + 120 mV rms at 120 Hz/100 Hz, IxP = VxP = ±100 mV rms
Output Frequency Variation		0.01		%	
DC Power Supply Rejection					VDD = 3.3 V ± 330 mV dc, IxP = VxP = ±100 mV rms
Output Frequency Variation		0.01		%	
Total Active Energy Measurement Bandwidth		2		kHz	
REACTIVE ENERGY MEASUREMENT (PSM0 MODE)					ADE7858A, ADE7868A, and ADE7878A
Reactive Energy Measurement Error (Per Phase)					
Total Reactive Energy		0.1		%	Over a dynamic range of 1000 to 1, PGA = 1, 2, 4; integrator off
		0.2		%	Over a dynamic range of 3000 to 1, PGA = 1, 2, 4; integrator off
Fundamental Reactive Energy		0.1		%	Over a dynamic range of 500 to 1, PGA = 8, 16; integrator on ADE7878A only
		0.1		%	Over a dynamic range of 1000 to 1, PGA = 1, 2, 4; integrator off
		0.2		%	Over a dynamic range of 3000 to 1, PGA = 1, 2, 4; integrator off
		0.1		%	Over a dynamic range of 500 to 1, PGA = 8, 16; integrator on
AC Power Supply Rejection					VDD = 3.3 V + 120 mV rms at 120 Hz/100 Hz, IxP = VxP = ±100 mV rms
Output Frequency Variation		0.01		%	
DC Power Supply Rejection					VDD = 3.3 V ± 330 mV dc, IxP = VxP = ±100 mV rms
Output Frequency Variation		0.01		%	
Total Reactive Energy Measurement Bandwidth		2		kHz	
RMS MEASUREMENTS (PSM0 MODE)					
Current (I) RMS and Voltage (V) RMS Measurement Bandwidth		2		kHz	
I RMS and V RMS Measurement Error		0.1		%	Over a dynamic range of 1000 to 1, PGA = 1
MEAN ABSOLUTE VALUE (MAV) MEASUREMENT (PSM1 Mode)					ADE7868A and ADE7878A
I MAV Measurement Bandwidth		260		Hz	
I MAV Measurement Error		0.5		%	Over a dynamic range of 100 to 1, PGA = 1, 2, 4, 8

Parameter ^{1, 2, 3}	Min	Typ	Max	Unit	Test Conditions/Comments
ANALOG INPUTS					
Maximum Signal Levels			±500	mV peak	PGA = 1, differential or single-ended inputs between the following pins: IAP and IAN, IBP and IBN, ICP and ICN, INP and INN; single-ended inputs between the following pins: VAP and VN, VBP and VN, VCP and VN
Input Impedance (DC) IAP, IAN, IBP, IBN, ICP, ICN, INP, INN, VAP, VBP, and VCP Pins	400			kΩ	
VN Pin	130			kΩ	
ADC Offset		-34		mV	PGA = 1; see the Terminology section
Gain Error		±4		%	External 1.2 V reference
WAVEFORM SAMPLING					
Current and Voltage Channels					Sampling CLKIN/2048, 16.384 MHz/2048 = 8 kSPS
Signal-to-Noise Ratio, SNR		74		dB	See the Waveform Sampling Mode section PGA = 1, fundamental frequency = 45 Hz to 65 Hz; see the Terminology section
Signal-to-Noise-and-Distortion (SINAD) Ratio		74		dB	PGA = 1, fundamental frequency = 45 Hz to 65 Hz; see the Terminology section
Bandwidth (-3 dB)		2		kHz	
TIME INTERVAL BETWEEN PHASES					
Measurement Error		0.3		Degrees	Line frequency = 45 Hz to 65 Hz, HPF on
CF1, CF2, CF3 PULSE OUTPUTS					
Maximum Output Frequency		8		kHz	WTHR = VARTH = VATHR = PMAX = 33,516,139
Duty Cycle		50		%	CF1, CF2, or CF3 frequency > 6.25 Hz, CFDEN is even and > 1
		(1 + 1/CFDEN) × 50%			CF1, CF2, or CF3 frequency > 6.25 Hz, CFDEN is odd and > 1
Active Low Pulse Width		80		ms	CF1, CF2, or CF3 frequency < 6.25 Hz
Jitter		0.04		%	CF1, CF2, or CF3 frequency = 1 Hz, nominal phase currents larger than 10% of full scale
REFERENCE INPUT					
REF _{IN/OUT} Input Voltage Range	1.1		1.3	V	Minimum = 1.2 V - 8%; maximum = 1.2 V + 8%
Input Capacitance			10	pF	
ON-CHIP REFERENCE, PSM0 AND PSM1 MODES					
Temperature Coefficient	-32	±5	+32	ppm/°C	Nominal 1.2 V at the REF _{IN/OUT} pin at T _A = 25°C Drift across the entire temperature range of -40°C to +85°C is calculated with reference to 25°C; see the Reference Circuit section
CLKIN					
Input Clock Frequency	16.22	16.384	16.55	MHz	CLKIN = 16.384 MHz; see the Crystal Circuit section
LOGIC INPUTS—MOSI/SDA, SCLK/SCL, SS /HSA, RESET, PM0, AND PM1					
Input High Voltage, V _{INH}	2.0			V	VDD = 3.3 V ± 10%
Input Low Voltage, V _{INL}			0.8	V	VDD = 3.3 V ± 10%
Input Current, I _{IN}			-8.7	μA	Input = 0 V, VDD = 3.3 V
			3	μA	Input = VDD = 3.3 V
Input Capacitance, C _{IN}		10		pF	
LOGIC OUTPUTS, IRQ0, IRQ1, MISO/HSD					
Output High Voltage, V _{OH}	2.4			V	VDD = 3.3 V ± 10%
I _{SOURCE}			800	μA	
Output Low Voltage, V _{OL}			0.4	V	VDD = 3.3 V ± 10%
I _{SINK}			2	mA	

Parameter ^{1, 2, 3}	Min	Typ	Max	Unit	Test Conditions/Comments
CF1, CF2, CF3/HSCLK					
Output High Voltage, V_{OH}	2.4			V	$V_{DD} = 3.3\text{ V} \pm 10\%$
I_{SOURCE}			500	μA	
Output Low Voltage, V_{OL}			0.4	V	$V_{DD} = 3.3\text{ V} \pm 10\%$
I_{SINK}			8	mA	
POWER SUPPLY					For specified performance
PSM0 Mode					
VDD Pin	2.97		3.63	V	Minimum = $3.3\text{ V} - 10\%$; maximum = $3.3\text{ V} + 10\%$
I_{DD}		20	23	mA	
PSM1 and PSM2 Modes					ADE7868A and ADE7878A
VDD Pin	2.8		3.7	V	
I_{DD}					
PSM1 Mode		4.5		mA	
PSM2 Mode		0.2		mA	
PSM3 Mode					
VDD Pin	2.8		3.7	V	
I_{DD}		1.7		μA	

¹ See the Typical Performance Characteristics section.

² See the Terminology section for a definition of the parameters.

³ Note that dual function pin names are referenced by the relevant function only (see the Pin Configuration and Function Descriptions section for full pin mnemonics and descriptions).

TIMING CHARACTERISTICS

VDD = 3.3 V ± 10%, AGND = DGND = 0 V, on-chip reference, CLKIN = 16.384 MHz, T_{MIN} to T_{MAX} = -40°C to +85°C. Note that within the timing tables and diagrams, dual function pin names are referenced by the relevant function only (see the Pin Configuration and Function Descriptions section for full pin mnemonics and descriptions).

I²C Interface Timing

Table 3.

Parameter	Symbol	Standard Mode		Fast Mode		Unit
		Min	Max	Min	Max	
SCL Clock Frequency	f _{SCL}	0	100	0	400	kHz
Hold Time for Start and Repeated Start Conditions	t _{HD;STA}	4.0		0.6		μs
Low Period of SCL Clock	t _{LOW}	4.7		1.3		μs
High Period of SCL Clock	t _{HIGH}	4.0		0.6		μs
Setup Time for Repeated Start Condition	t _{SU;STA}	4.7		0.6		μs
Data Hold Time	t _{HD;DAT}	0	3.45	0	0.9	μs
Data Setup Time	t _{SU;DAT}	250		100		ns
Rise Time of SDA and SCL Signals	t _R		1000	20	300	ns
Fall Time of SDA and SCL Signals	t _F		300	20	300	ns
Setup Time for Stop Condition	t _{SU;STO}	4.0		0.6		μs
Bus Free Time Between a Stop and Start Condition	t _{BUF}	4.7		1.3		μs
Pulse Width of Suppressed Spikes	t _{SP}	N/A ¹			50	ns

¹ N/A means not applicable.



Figure 5. I²C Interface Timing

11136-005

SPI Interface Timing

Table 4.

Parameter	Symbol	Min	Max	Unit
\overline{SS} to SCLK Edge	t_{SS}	50		ns
SCLK Period		0.4	4000 ¹	μ s
SCLK Low Pulse Width	t_{SL}	175		ns
SCLK High Pulse Width	t_{SH}	175		ns
Data Output Valid After SCLK Edge	t_{DAV}		100	ns
Data Input Setup Time Before SCLK Edge	t_{DSU}	100		ns
Data Input Hold Time After SCLK Edge	t_{DHD}	5		ns
Data Output Fall Time	t_{DF}		20	ns
Data Output Rise Time	t_{DR}		20	ns
SCLK Rise Time	t_{SR}		20	ns
SCLK Fall Time	t_{SF}		20	ns
MISO Disable After \overline{SS} Rising Edge	t_{DIS}		200	ns
\overline{SS} High After SCLK Edge	t_{SFS}	0		ns

¹ Guaranteed by design.

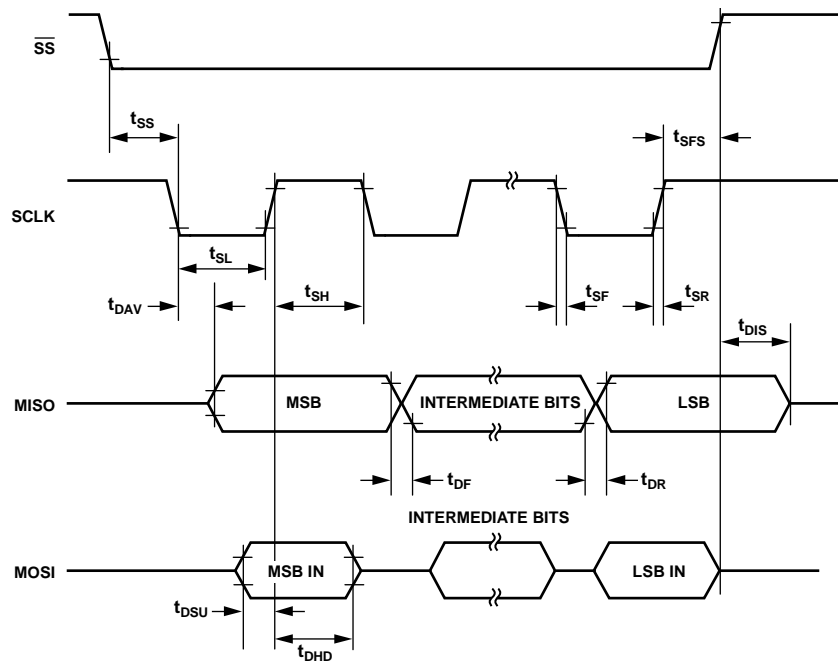

Figure 6. SPI Interface Timing

11136-006

HSDC Interface Timing

Table 5.

Parameter	Symbol	Min	Max	Unit
HSA to HCLK Edge	t_{SS}	0		ns
HCLK Period		125		ns
HCLK Low Pulse Width	t_{SL}	50		ns
HCLK High Pulse Width	t_{SH}	50		ns
Data Output Valid After HCLK Edge	t_{DAV}		40	ns
Data Output Fall Time	t_{DF}		20	ns
Data Output Rise Time	t_{DR}		20	ns
HCLK Rise Time	t_{SR}		10	ns
HCLK Fall Time	t_{SF}		10	ns
HSD Disable After HSA Rising Edge	t_{DIS}	5		ns
HSA High After HCLK Edge	t_{SFS}	0		ns



Figure 7. HSDC Interface Timing

Load Circuit for Timing Specifications

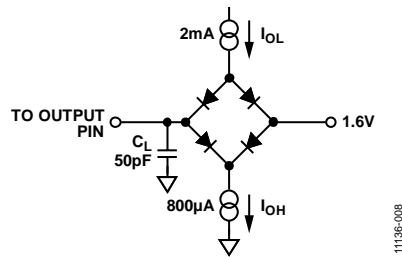

Figure 8. Load Circuit for Timing Specifications

ABSOLUTE MAXIMUM RATINGS

$T_A = 25^\circ\text{C}$, unless otherwise noted.

Table 6.

Parameter	Rating
VDD to AGND	-0.3 V to +3.7 V
VDD to DGND	-0.3 V to +3.7 V
Analog Input Voltage to AGND, IAP, IAN, IBP, IBN, ICP, ICN, VAP, VBP, VCP, VN	-2 V to +2 V
Analog Input Voltage to INP and INN	-2 V to +2 V
Reference Input Voltage to AGND	-0.3 V to VDD + 0.3 V
Digital Input Voltage to DGND	-0.3 V to VDD + 0.3 V
Digital Output Voltage to DGND	-0.3 V to VDD + 0.3 V
Operating Temperature	
Industrial Range	-40°C to +85°C
Storage Temperature Range	-65°C to +150°C
Lead Temperature (Soldering, 10 sec)	300°C

Stresses at or above those listed under Absolute Maximum Ratings may cause permanent damage to the product. This is a stress rating only; functional operation of the product at these or any other conditions above those indicated in the operational section of this specification is not implied. Operation beyond the maximum operating conditions for extended periods may affect product reliability.

THERMAL RESISTANCE

θ_{JA} is specified at $29.3^\circ\text{C}/\text{W}$; θ_{JC} is specified at $1.8^\circ\text{C}/\text{W}$.

Table 7. Thermal Resistance

Package Type	θ_{JA}	θ_{JC}	Unit
40-Lead LFCSP	29.3	1.8	$^\circ\text{C}/\text{W}$

ESD CAUTION



ESD (electrostatic discharge) sensitive device.

Charged devices and circuit boards can discharge without detection. Although this product features patented or proprietary protection circuitry, damage may occur on devices subjected to high energy ESD. Therefore, proper ESD precautions should be taken to avoid performance degradation or loss of functionality.

PIN CONFIGURATION AND FUNCTION DESCRIPTIONS



Figure 9. Pin Configuration

Table 8. Pin Function Descriptions

Pin No.	Mnemonic	Description
1, 10, 11, 21, 30, 31, 40	NC	No Connect. These pins are not connected internally. It is recommended that these pins be grounded.
2	PM0	Power Mode Pin 0. The PM0 and PM1 pins together specify the power mode of the ADE7854A , ADE7858A , ADE7868A , and ADE7878A (see Table 9).
3	PM1	Power Mode Pin 1. The PM1 and PM0 pins together specify the power mode of the ADE7854A , ADE7858A , ADE7868A , and ADE7878A (see Table 9).
4	RESET	Reset Input, Active Low. In PSM0 mode, this pin must stay low for at least 10 μ s to trigger a hardware reset.
5	DVDD	2.5 V Output of the Digital Low Dropout (LDO) Regulator. Decouple this pin with a 4.7 μ F capacitor in parallel with a ceramic 220 nF capacitor. Do not connect external active circuitry to this pin.
6	DGND	Ground Reference for the Digital Circuitry.
7, 8	IAP, IAN	Analog Inputs, Current Channel A. Current Channel A is used with the current transducers. The IAP (positive) and IAN (negative) inputs are fully differential voltage inputs with a maximum differential level of ± 0.5 V peak. Channel A also has an internal PGA, which is set to the same value as the PGAs used by Channel B and Channel C.
9, 12	IBP, IBN	Analog Inputs, Current Channel B. Current Channel B is used with the current transducers.. The IBP (positive) and IBN (negative) inputs are fully differential voltage inputs with a maximum differential level of ± 0.5 V peak. Channel B also has an internal PGA, which is set to the same value as the PGAs used by Channel A and Channel C.
13, 14	ICP, ICN	Analog Inputs, Current Channel C. Current Channel C is used with the current transducers. The ICP (positive) and ICN (negative) inputs are fully differential voltage inputs with a maximum differential level of ± 0.5 V peak. Channel C also has an internal PGA, which is set to the same value as the PGAs used by Channel A and Channel B.
15, 16	INP, INN	Analog Inputs, Neutral Current Channel N. Current Channel N is used with the current transducers. The INP (positive) and INN (negative) inputs are fully differential voltage inputs with a maximum differential level of ± 0.5 V peak. Channel N also has an internal PGA, which is separate from the PGA used by Channel A, Channel B, and Channel C. The neutral current channel is available in the ADE7868A and ADE7878A only. In the ADE7854A and ADE7858A , connect the INP and INN pins to AGND.
17	REF _{IN/OUT}	The REF _{IN/OUT} pin provides access to the on-chip voltage reference. The on-chip reference has a nominal value of 1.2 V. An external reference source with $1.2\text{ V} \pm 8\%$ can also be connected at this pin. In either case, decouple REF _{IN/OUT} to AGND with a 4.7 μ F capacitor in parallel with a ceramic 100 nF capacitor. After a reset, the on-chip reference is enabled.

Pin No.	Mnemonic	Description
18, 19, 22, 23	VN, VCP, VBP, VAP	Analog Inputs, Voltage Channels. These channels are used with the voltage transducer. The VN, VCP, VBP, and VAP inputs are single-ended voltage inputs with a maximum signal level of ± 0.5 V peak with respect to VN for specified operation. Each voltage channel also has an internal PGA.
20	REF_GND	Ground Reference, Internal Voltage Reference. Connect REF_GND to the analog ground plane.
24	AVDD	2.5 V Output of the Analog Low Dropout (LDO) Regulator. Decouple this pin with a 4.7 μ F capacitor in parallel with a ceramic 220 nF capacitor. Do not connect external active circuitry to this pin.
25	AGND	Ground Reference for the Analog Circuitry. Tie AGND to the analog ground plane or to the quietest ground reference in the system. Use this quiet ground reference for all analog circuitry, for example, antialiasing filters, current transducers, and voltage transducers.
26	VDD	Supply Voltage. The VDD pin provides the supply voltage. In PSM0 (normal power) mode, maintain the supply voltage at $3.3 \text{ V} \pm 10\%$ for specified operation. In PSM1 (reduced power) mode, PSM2 (low power) mode, and PSM3 (sleep) mode, when the ADE7868A or ADE7878A is supplied from a battery, maintain the supply voltage from 2.8 V to 3.7 V. Decouple VDD to AGND with a 10 μ F capacitor in parallel with a ceramic 100 nF capacitor. The only power modes available on the ADE7858A and ADE7854A are the PSM0 and PSM3 modes.
27	CLKIN	Master Clock. An external clock can be provided at this logic input. Alternatively, a crystal can be connected across the CLKIN and CLKOUT pins to provide a clock source for the ADE7854A, ADE7858A, ADE7868A, or ADE7878A. The clock frequency for specified operation is 16.384 MHz. For information about choosing a suitable crystal, see the Crystal Circuit section.
28	CLKOUT	Crystal Output. A crystal can be connected across the CLKIN and CLKOUT pins to provide a clock source for the ADE7854A, ADE7858A, ADE7868A, or ADE7878A. The clock frequency for specified operation is 16.384 MHz. For information about choosing a suitable crystal, see the Crystal Circuit section.
29, 32	$\overline{\text{IRQ0}}$, $\overline{\text{IRQ1}}$	Interrupt Request Outputs. These pins are active low logic outputs. For information about events that trigger interrupts, see the Interrupts section.
33, 34, 35	CF1, CF2, CF3/HSCLK	Calibration Frequency Logic Outputs/Serial Clock Output of the HSDC Port. The CF1, CF2, and CF3/HSCLK outputs provide power information based on the CF1SEL[2:0], CF2SEL[2:0], and CF3SEL[2:0] bits in the CFMODE register. Use these outputs for operational and calibration purposes. Scale the full-scale output frequency by writing to the CF1DEN, CF2DEN, and CF3DEN registers (see the Energy to Frequency Conversion section). CF3 is multiplexed with HSCLK.
36	SCLK/SCL	Serial Clock Input for the SPI Port/Serial Clock Input for the I ² C Port. All serial data transfers synchronize to this clock (see the Serial Interfaces section). The SCLK/SCL pin has a Schmitt trigger input for use with a clock source that has a slow edge transition time, for example, opto-isolator outputs.
37	MISO/HSD	Data Output for the SPI Port/Data Output for the HSDC Port.
38	MOSI/SDA	Data Input for the SPI Port/Data Input and Output for the I ² C Port.
39	$\overline{\text{SS}}$ /HSA	Slave Select for the SPI Port/HSDC Port Active.
	EP	Exposed Pad. Create a similar pad on the printed circuit board (PCB) under the exposed pad. Solder the exposed pad to the pad on the PCB to confer mechanical strength to the package. Connect the pads to AGND and DGND.

TYPICAL PERFORMANCE CHARACTERISTICS

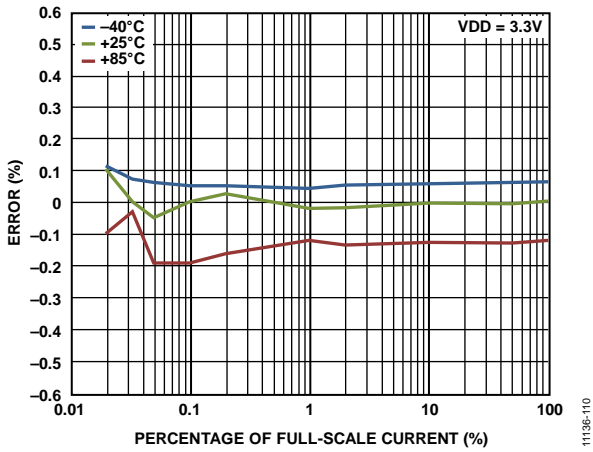

Figure 10. Total Active Energy Error as a Percentage of Reading (Gain = +1, Power Factor = 1) vs. Percentage of Full-Scale Current over Temperature with Internal Reference and Integrator Off

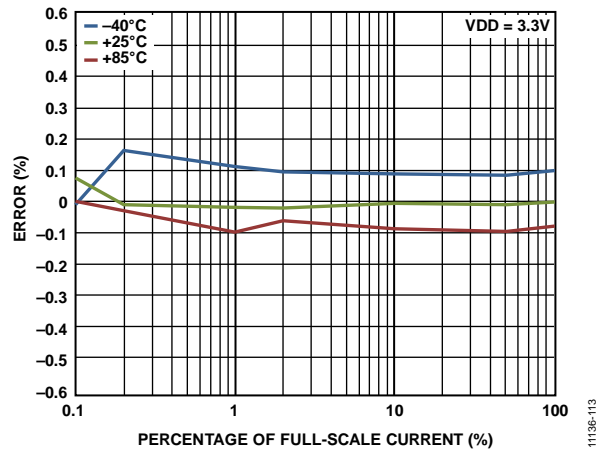

Figure 13. Total Active Energy Error as a Percentage of Reading (Gain = +16, Power Factor = 1) vs. Percentage of Full-Scale Current over Temperature with Internal Reference and Integrator On

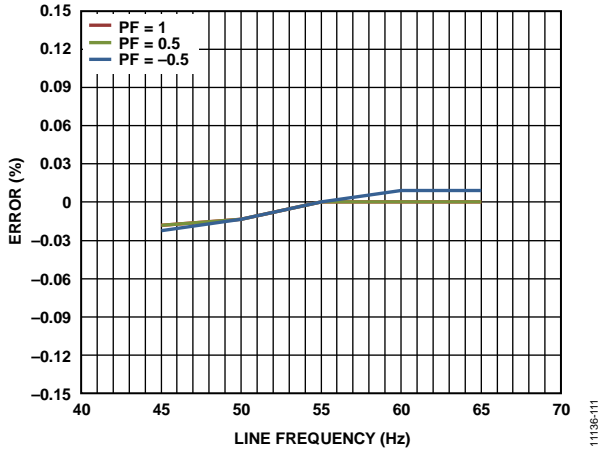

Figure 11. Total Active Energy Error as a Percentage of Reading (Gain = +1) vs. Line Frequency over Power Factor with Internal Reference and Integrator Off

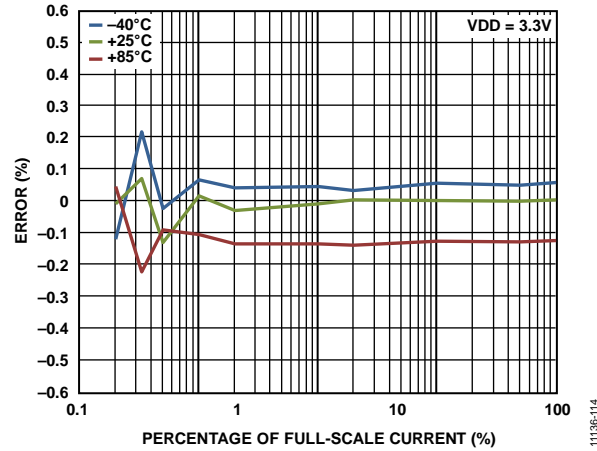

Figure 14. Total Reactive Energy Error as a Percentage of Reading (Gain = +1, Power Factor = 0) vs. Percentage of Full-Scale Current over Temperature with Internal Reference and Integrator Off

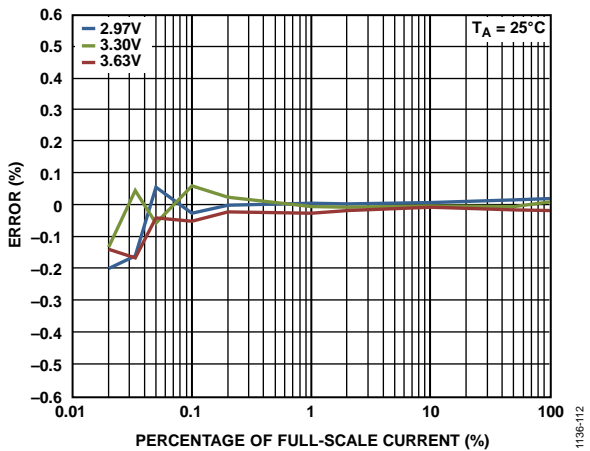

Figure 12. Total Active Energy Error as a Percentage of Reading (Gain = +1, Power Factor = 1) vs. Percentage of Full-Scale Current over Power Supply with Internal Reference and Integrator Off

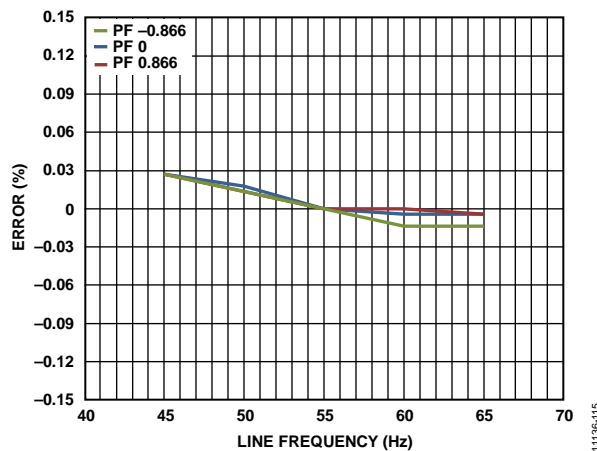

Figure 15. Total Reactive Energy Error as a Percentage of Reading (Gain = +1) vs. Line Frequency over Power Factor with Internal Reference and Integrator Off

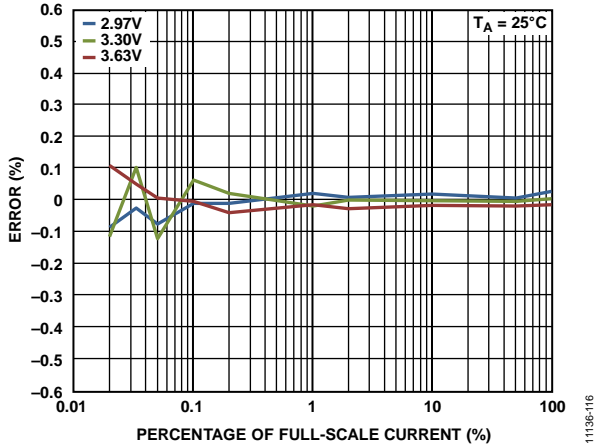

Figure 16. Total Reactive Energy Error as a Percentage of Reading (Gain = +1, Power Factor = 0) vs. Percentage of Full-Scale Current over Power Supply with Internal Reference and Integrator Off

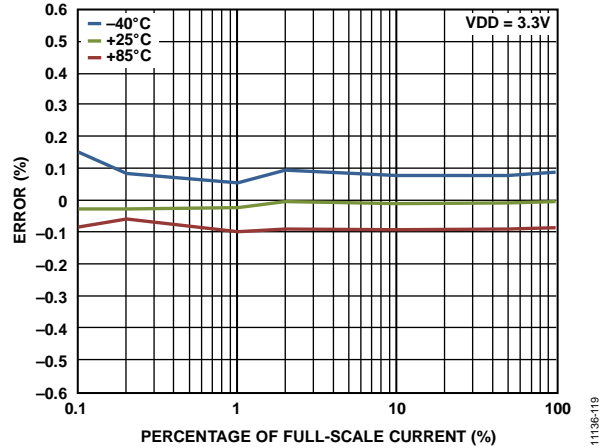

Figure 19. Fundamental Active Energy Error as a Percentage of Reading (Gain = +16) vs. Percentage of Full-Scale Current over Temperature with Internal Reference and Integrator On

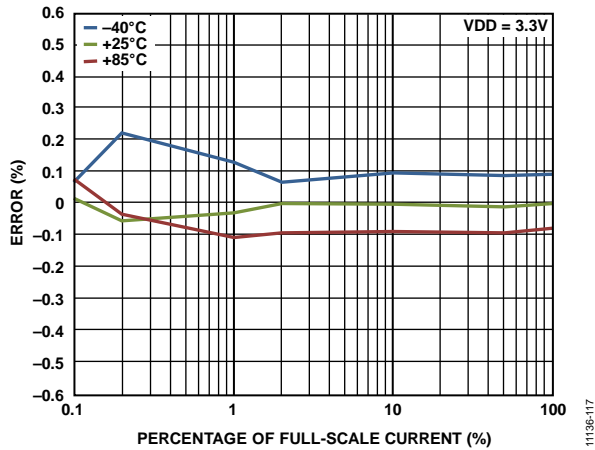

Figure 17. Total Reactive Energy Error as a Percentage of Reading (Gain = +16, Power Factor = 0) vs. Percentage of Full-Scale Current over Temperature with Internal Reference and Integrator On

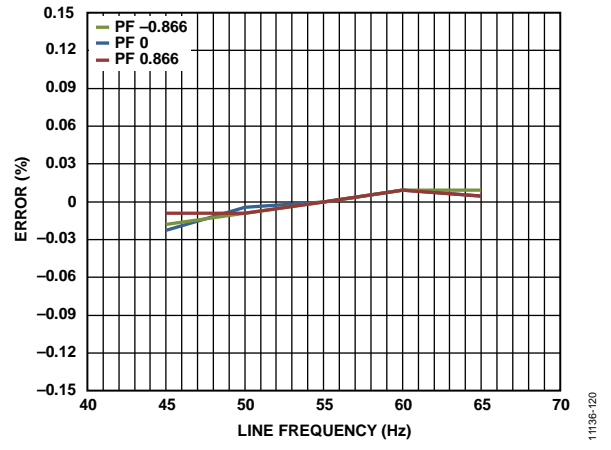

Figure 20. Fundamental Reactive Energy Error as a Percentage of Reading (Gain = +1) vs. Line Frequency over Power Factor with Internal Reference and Integrator Off

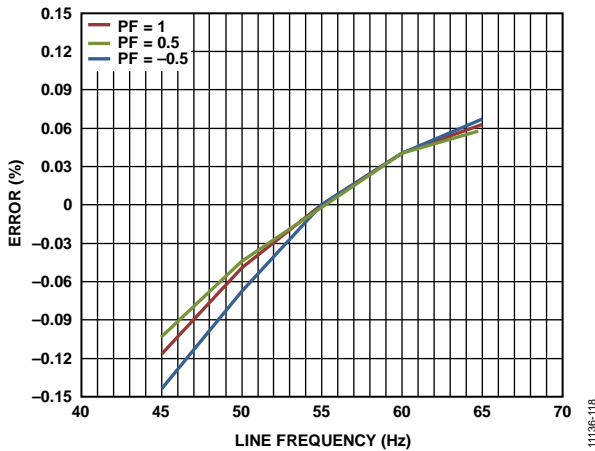

Figure 18. Fundamental Active Energy Error as a Percentage of Reading (Gain = +1) vs. Line Frequency over Power Factor over Frequency with Internal Reference and Integrator Off

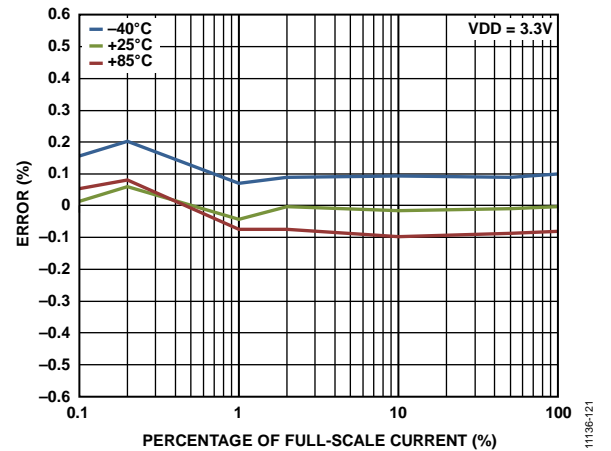

Figure 21. Fundamental Reactive Energy Error as a Percentage of Reading (Gain = +16) vs. Percentage of Full-Scale Current over Temperature with Internal Reference and Integrator On



Figure 22. I RMS Error as a Percentage of Reading (Gain = +1, Power Factor = 1) vs. Percentage of Full-Scale Current over Temperature with Internal Reference and Integrator Off

TEST CIRCUIT

In Figure 23, the PM1 and PM0 pins are pulled up internally to VDD. Select the mode of operation by using a microcontroller to programmatically change the pin values (see the Power Management section).



Figure 23. Test Circuit

11136-015

TERMINOLOGY

Measurement Error

The error associated with the energy measurement made by the ADE7854A/ADE7858A/ADE7868A/ADE7878A is defined as follows:

$$\text{Measurement Error} = \frac{\text{Energy Registered by Device} - \text{True Energy}}{\text{True Energy}} \times 100\% \quad (1)$$

where *Device* represents the ADE7854A, ADE7858A, ADE7868A, or ADE7878A.

Power Supply Rejection (PSR)

PSR quantifies the ADE7854A/ADE7858A/ADE7868A/ADE7878A measurement error as a percentage of reading when the power supplies are varied. For the ac PSR measurement, a reading at nominal supplies (3.3 V) is taken. A second reading is obtained with the same input signal levels when an ac signal (120 mV rms at twice the fundamental frequency) is introduced onto the supplies. Any error introduced by this ac signal is expressed as a percentage of reading.

For the dc PSR measurement, a reading at nominal supplies (3.3 V) is taken. A second reading is obtained with the same input signal levels when the power supplies are varied by $\pm 10\%$. Any error introduced is expressed as a percentage of the reading.

ADC Offset

ADC offset refers to the dc offset associated with the analog inputs to the ADCs. It means that with the analog inputs connected to AGND, the ADCs still see a dc analog input signal. The magnitude of the offset depends on the gain and input range selection. The high-pass filter (HPF) removes the offset from the current and voltage channels; therefore, the power calculation remains unaffected by this offset.

Gain Error

The gain error in the ADCs of the ADE7854A/ADE7858A/ADE7868A/ADE7878A is defined as the difference between the measured ADC output code (minus the offset) and the ideal output code (see the Current Channel ADC and Voltage Channel ADC sections). The difference is expressed as a percentage of the ideal code.

CF Jitter

The period of pulses at one of the CF1, CF2, or CF3/HSCLK pins is continuously measured. The maximum, minimum, and average values of four consecutive pulses are computed, as follows:

$$\text{Maximum} = \max(\text{Period}_0, \text{Period}_1, \text{Period}_2, \text{Period}_3)$$

$$\text{Minimum} = \min(\text{Period}_0, \text{Period}_1, \text{Period}_2, \text{Period}_3)$$

$$\text{Average} = \frac{\text{Period}_0 + \text{Period}_1 + \text{Period}_2 + \text{Period}_3}{4}$$

The CF jitter is then computed as follows:

$$CF_{\text{JITTER}} = \frac{\text{Maximum} - \text{Minimum}}{\text{Average}} \times 100\% \quad (2)$$

Signal-to-Noise Ratio (SNR)

SNR is the ratio of the rms value of the actual input signal to the rms sum of all other spectral components below 2 kHz, excluding harmonics and dc. The input signal contains only the fundamental component. The spectral components are calculated over a 2 sec window. The value for SNR is expressed in decibels.

Signal-to-Noise-and-Distortion (SINAD) Ratio

SINAD is the ratio of the rms value of the actual input signal to the rms sum of all other spectral components below 2 kHz, including harmonics but excluding dc. The input signal contains only the fundamental component. The spectral components are calculated over a 2 sec window. The value for SINAD is expressed in decibels.

POWER MANAGEMENT

The [ADE7868A/ADE7878A](#) have four modes of operation and the [ADE7854A/ADE7858A](#) have two modes of operation; the modes of operation are determined by the state of the PM0 and PM1 pins (see Table 9).

Table 9. Power Supply Modes

Power Supply Mode	PM1 Pin	PM0 Pin
PSM0, Normal Power Mode	0	1
PSM1, Reduced Power Mode ¹	0	0
PSM2, Low Power Mode ¹	1	0
PSM3, Sleep Mode	1	1

¹ Available in the [ADE7868A](#) and [ADE7878A](#) only.

The PM1 and PM0 pins control the operation of the [ADE7854A/ADE7858A/ADE7868A/ADE7878A](#). These pins are easily connected to an external microprocessor input/output. The PM1 and PM0 pins include internal pull-up resistors; therefore, the [ADE7854A/ADE7858A/ADE7868A/ADE7878A](#) are in sleep mode by default. For recommended actions to take before and after setting a new power mode, see Table 11 and Table 12.

PSM0 NORMAL POWER MODE (ALL DEVICES)

In PSM0 normal power mode (PSM0 mode), the [ADE7854A/ADE7858A/ADE7868A/ADE7878A](#) are fully functional. To enter PSM0 mode, the PM1 pin is set low and the PM0 pin is set high. When a device is in PSM1, PSM2, or PSM3 mode and switches to PSM0 mode, all control registers revert to their default values, except for the threshold register, LPOILVL (which is used in PSM2 mode), and the CONFIG2 register. These registers maintain their programmed values.

The [ADE7854A/ADE7858A/ADE7868A/ADE7878A](#) signal the completion of the power-up procedure by driving the [IRQ1](#) interrupt pin low and setting Bit 15 (RSTDONE) in the STATUS1 register to 1. Bit 15 is cleared to 0 during the power-up sequence and is set to 1 when the chip enters PSM0 mode. Writing to the STATUS1 register with the RSTDONE bit set to 1 clears the status bit and returns the [IRQ1](#) pin high.

The RSTDONE interrupt cannot be masked because Bit 15 (RSTDONE) in the interrupt mask register has no functionality.

PSM1 REDUCED POWER MODE (ADE7868A AND ADE7878A ONLY)

The PSM1 reduced power mode (PSM1 mode) is available on the [ADE7868A](#) and [ADE7878A](#) only. In PSM1 mode, the [ADE7868A/ADE7878A](#) measure the mean absolute values (MAV) of the 3-phase currents and store the results in the 20-bit AIMAV, BIMAV, and CIMAV registers. PSM1 mode is useful in missing neutral cases where an external battery provides the voltage supply for the [ADE7868A](#) or [ADE7878A](#).

The I²C or SPI serial port is enabled in PSM1 mode and can be used to read the AIMAV, BIMAV, and CIMAV registers. Do not read any other registers because their values are not guaranteed in PSM1 mode. Similarly, a write operation in PSM1 mode is ignored by the [ADE7868A/ADE7878A](#). In PSM1 mode, do not access any registers other than AIMAV, BIMAV, and CIMAV. For more information about the xIMAV registers, see the Current Mean Absolute Value Calculation—[ADE7868A](#) and [ADE7878A](#) Only section.

The circuit that measures the estimates of rms values is also active during PSM0 mode; therefore, the calibration of this circuit can be done in either PSM0 mode or PSM1 mode. Note that the [ADE7868A](#) and [ADE7878A](#) do not provide registers to store or process the corrections resulting from the calibration process. The external microprocessor stores the gain values from these measurements and uses them during PSM1 mode.

The 20-bit mean absolute value measurements that are completed in PSM1 mode are available in PSM0 mode. However, the MAV values are different from the rms measurements of phase currents and voltages that are executed only in PSM0 mode and stored in the xRMS and xVRMS 24-bit registers. For more information, see the Current Mean Absolute Value Calculation—[ADE7868A](#) and [ADE7878A](#) Only section.

If the [ADE7868A/ADE7878A](#) are set to PSM1 mode while configured for PSM0 mode, the devices immediately begin the mean absolute value calculations. The xIMAV registers are accessible at any time; however, if the [ADE7878A](#) or [ADE7868A](#) is set to PSM1 mode while configured for PSM2 or PSM3 mode, the [ADE7868A/ADE7878A](#) signal the start of the mean absolute value computations by driving the [IRQ1](#) pin low. The xIMAV registers can be accessed only after the [IRQ1](#) pin is low.

PSM2 LOW POWER MODE (ADE7868A AND ADE7878A ONLY)

The PSM2 low power mode (PSM2 mode) is available on the [ADE7868A](#) and [ADE7878A](#) only. PSM2 mode reduces the power consumption required to monitor the currents when there is no voltage input, and an external battery provides the voltage supply for the [ADE7868A/ADE7878A](#).

PSM2 mode detects a missing neutral tamper condition by monitoring all phase currents and comparing them with a programmable threshold. If any phase current rises above the programmable threshold for a programmable period, the device assumes that a tamper attack has occurred. If all currents remain below the programmable threshold, no tamper attack has taken place; instead, a simple power outage has occurred.

When a missing neutral tamper condition occurs, the external microprocessor sets the [ADE7868A/ADE7878A](#) to PSM1 mode, measures the mean absolute values of the phase currents, and integrates the energy based on these values and the nominal voltage. The I²C or SPI port is not functional during this mode.

It is best practice to use the ADE7868A/ADE7878A in PSM2 mode when the PGA1 gain is 1 or 2. PGA1 represents the gain in the current channel datapath. Do not use the ADE7868A or ADE7878A in PSM2 mode when the PGA1 gain is 4, 8, or 16.

Two PSM2 modes of operation are available: PSM2 interrupt mode and PSM2 $\overline{\text{IRQ1}}$ only mode. The PSM2 interrupt mode is the default mode. If the use of an external timer is possible, use the PSM2 $\overline{\text{IRQ1}}$ only mode.

The PSM2 level threshold comparison is based on a peak detection methodology. The peak detection circuit makes the comparison based on the positive terminal current channel input, I_{AP} , I_{BP} , and I_{CP} (see Figure 24). If differential inputs are applied to the current channels, Figure 24 shows the differential antiphase signals at each current input terminal, I_{XP} and I_{XN} , and the net differential current, $I_{XP} - I_{XN}$.

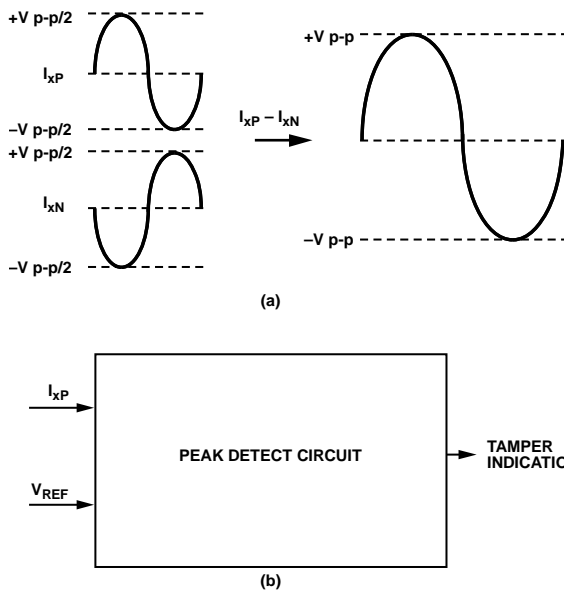

Figure 24. PSM2 Low Power Mode Peak Detection

PSM2 Interrupt Mode (Default)

In PSM2 interrupt mode, the ADE7868A/ADE7878A compare all phase currents against the programmable threshold for the programmable period of time. During this time, if one phase current exceeds the threshold, a counter is incremented. If a single phase counter is greater than or equal to $LPLINE[4:0] + 1$ at the end of the measurement period, the $\overline{\text{IRQ1}}$ pin is pulled low. If every phase counter remains below $LPLINE[4:0] + 1$ at the end of the measurement period, the $\overline{\text{IRQ0}}$ pin is pulled low.

In this way, a combination of the $\overline{\text{IRQ0}}$ and $\overline{\text{IRQ1}}$ pins is used to determine the outcome of the measurement as follows:

- $\overline{\text{IRQ0}}$ pulled low: no tamper detected. When the $\overline{\text{IRQ0}}$ pin is pulled low at the end of a measurement period, it indicates that all phase currents are below the defined threshold and, therefore, no current is flowing through the system. In this case, the device does not detect a tamper condition. The external microprocessor sets the ADE7868A/ADE7878A to PSM3 sleep mode.

- $\overline{\text{IRQ1}}$ pulled low: missing neutral tamper condition detected. When the $\overline{\text{IRQ1}}$ pin is pulled low at the end of the measurement period, it indicates that at least one current input is above the defined threshold and current is flowing through the system, although no voltage is present at the ADE7868A/ADE7878A pins. This condition indicates the occurrence of a missing neutral tamper condition. At this point, the external microprocessor sets the ADE7868A/ADE7878A to PSM1 mode, measures the mean absolute values of the phase currents, and integrates the energy based on these values and the nominal voltage.

Setting the Measurement Period

The measurement period is defined by Bits[7:3] ($LPLINE[4:0]$) of the LPOILVL register (Address 0xEC00). The measurement period is independent of the line frequency and is defined as

$$\text{Measurement Period (sec)} = 0.02 \times (LPLINE[4:0] + 10)$$

Setting the Threshold

The threshold is defined by Bits[2:0] ($LPOIL[2:0]$) of the LPOILVL register (see Table 10). The threshold level is for signal levels with the PGA set to 1. When $LPOIL[2:0] = 111$, the absolute value of the threshold typically varies by up to $\pm 30\%$.

Table 10. LPOILVL Register

Bits	Bit Name	Value	Description
[2:0]	LPOIL[2:0]		Input signal levels that correspond to the following thresholds:
		000	71 mV rms
		001	Reserved
		010	Reserved
		011	1 mV rms
		100	Reserved
		101	Reserved
		110	Reserved
		111	0.471 mV rms
[7:3]	LPLINE[4:0]		Default value is 00000. Measurement period in PSM2 interrupt mode is $0.02 \times (LPLINE[4:0] + 10)$ sec. Measurement period in PSM2 $\overline{\text{IRQ1}}$ only mode is $0.02 \times (LPLINE[4:0] + 1)$ sec.

Figure 25 shows the typical variation around each threshold level; the gray regions in Figure 25 indicate where the feature may not yield expected and uniform results. The current levels outside this gray range help detect a tamper condition. For example, setting the threshold to 0.471 mV rms provides dependable tamper detection results for current levels above 0.707 mV rms and below 0.353 mV rms.



Figure 25. Variation Around Each Threshold Setting

Figure 26 shows the behavior of the ADE7868A/ADE7878A PSM2 mode when LPLINE[4:0] = 2. The test period is 12 cycles at 50 Hz (240 ms); the Phase A current rises above the LPOIL[2:0] threshold five times. Because the counter value is above the internal counter requirement of LPLINE[4:0] + 1, the $\overline{\text{IRQ1}}$ pin is pulled low at the end of the test period. This result suggests that a missing neutral tamper condition has occurred.

PSM2 $\overline{\text{IRQ1}}$ Only Mode

The PSM2 $\overline{\text{IRQ1}}$ only mode uses only the $\overline{\text{IRQ1}}$ pin to indicate a tamper event. If no tamper event has occurred, no signal is provided by the ADE7868A or ADE7878A.

To disable the $\overline{\text{IRQ0}}$ pin and thus enable the PSM2 $\overline{\text{IRQ1}}$ only mode, set Bit 2 (IRQ0_DIS) in the CONFIG2 register (Address 0xEC01) to 1. Selecting this mode defines the recommended measurement period using the following formula:

$$\text{Recommended Measurement Period (sec)} = 0.02 \times (\text{LPLINE}[4:0] + 1)$$

Because a wait is required during this measurement period, use an external timer before checking the status of the $\overline{\text{IRQ1}}$ interrupt. The measurement period can be longer than the recommended period because the internal phase counter continues to increment for the entire time that the device is in PSM2 mode. Switching to PSM3 mode and then back to PSM2 mode causes the device to enter the PSM2 interrupt mode (the default PSM2 mode).

PSM3 SLEEP MODE (ALL DEVICES)

PSM3 sleep mode is available on all devices: ADE7854A, ADE7858A, ADE7868A, and ADE7878A. In sleep mode, most of the internal circuits in the devices are turned off and the current consumption is at its lowest level. When configuring the device for sleep mode, set the $\overline{\text{RESET}}$, SCLK/SCL, MOSI/SDA, and $\overline{\text{SS/HSA}}$ pins high.

In PSM3 sleep mode, the I²C, HSDC, and SPI ports are not functional.

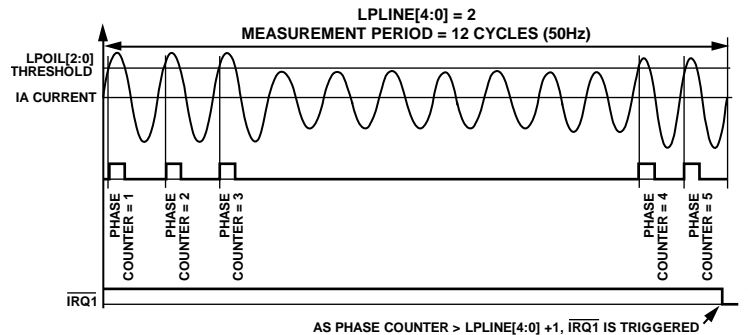

Figure 26. PSM2 Interrupt Mode Triggering $\overline{\text{IRQ1}}$ Pin for LPLINE[4:0] = 2 (50 Hz Systems)

Table 11. Power Modes and Related Characteristics

Power Mode	LPOILVL and CONFIG2 Registers	All Other Registers ¹	I ² C/SPI Port	Functionality
PSM0 After Hardware Reset	Set to default values	Set to default values	I ² C port enabled	All circuits are active and DSP is in idle mode
After Software Reset	Unchanged	Set to default values	If the lock-in procedure was previously executed, the active serial port is unchanged	All circuits are active and DSP is in idle mode
PSM1 (ADE7868A and ADE7878A Only)	Values set during PSM0 mode are unchanged	Not available	I ² C or SPI port enabled, but with limited functionality	Current mean absolute values are computed, and the results are stored in the AIMAV, BIMAV, and CIMAV registers
PSM2 (ADE7868A and ADE7878A Only)	Values set during PSM0 mode are unchanged	Not available	Serial port disabled	Compares phase currents against the threshold set in the LPOILVL register and triggers the IRQ0 or IRQ1 pin accordingly
PSM3	Values set during PSM0 mode are unchanged	Not available	Serial port disabled	Internal circuits are shut down

¹ Setting for all registers except the LPOILVL and CONFIG2 registers.

Table 12. Recommended Actions When Changing Power Modes

Initial Power Mode	Recommended Actions Before Setting Next Power Mode	Next Power Mode			
		PSM0	PSM1	PSM2	PSM3
PSM0	Stop the DSP by setting the run register to 0x0000. Disable HSDC by clearing Bit 6 (HSDCEN) to 0 in the CONFIG register. Mask interrupts by setting MASK0 and MASK1 registers to 0x0. Erase interrupt status flags in the STATUS0 and STATUS1 registers.		Current mean absolute values (MAV) computed immediately. xIMAV registers immediately accessible.	Wait until the IRQ0 or IRQ1 pin is pulled low.	No action necessary.
PSM1 (ADE7868A and ADE7878A Only)	No action necessary.	Wait until the IRQ1 pin is pulled low. Poll the STATUS1 register until Bit 15 (RSTDONE) is set to 1.		Wait until the IRQ0 or IRQ1 pin is pulled low.	No action necessary.
PSM2 (ADE7868A and ADE7878A Only)	No action necessary.	Wait until the IRQ1 pin is pulled low. Poll the STATUS1 register until Bit 15 (RSTDONE) is set to 1.	Wait until the IRQ1 pin is pulled low. Current mean absolute values computed after IRQ1 pin is pulled low. xIMAV registers accessible after IRQ1 pin is pulled low.		No action necessary.
PSM3	No action necessary.	Wait until the IRQ1 pin is pulled low. Poll the STATUS1 register until Bit 15 (RSTDONE) is set to 1.	Wait until the IRQ1 pin is pulled low. Current mean absolute values computed after IRQ1 pin is pulled low. xIMAV registers accessible after IRQ1 pin is pulled low.	Wait until the IRQ0 or IRQ1 pin is pulled low.	

POWER-UP PROCEDURE

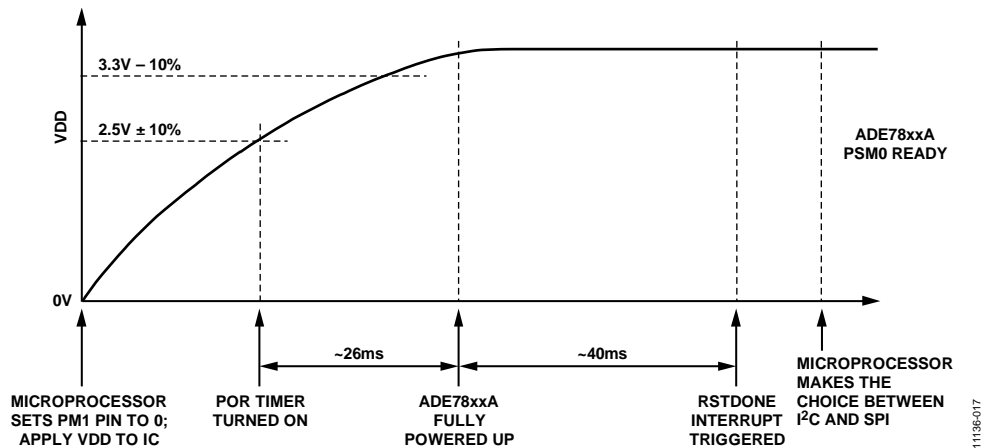

Figure 27. Power-Up Procedure

The [ADE7854A/ADE7858A/ADE7868A/ADE7878A](#) contain an on-chip power supply monitor that supervises the power supply (VDD). At power-up, the device is inactive until VDD reaches 2.5 V ± 10%. When VDD crosses this threshold, the power supply monitor keeps the device in the inactive state for an additional 26 ms to allow VDD to rise to 3.3 V - 10%, the minimum recommended supply voltage.

The PM0 and PM1 pins have internal pull-up resistors, but it is necessary to set the PM1 pin to Logic 0 either through a microcontroller or by grounding the PM1 pin externally, before powering up the chip. The PM0 pin can remain open as it is held high, due to the internal pull-up resistor. This ensures that [ADE7854A/ADE7858A/ADE7868A/ADE7878A](#) always power up in PSM0 (normal) mode. The time taken from the chip being powered up completely to the state where all functionality is enabled, is about 40 ms (see Figure 27). It is necessary to ensure that the **RESET** pin is held high during the entire power-up procedure.

If PSM0 mode is the only desired power mode, the PM1 pin can be tied to ground externally. When the [ADE7854A/ADE7858A/ADE7868A/ADE7878A](#) enter PSM0 mode, the I²C port is the active serial port. To use the SPI port, toggle the \overline{SS}/HSA pin three times from high to low.

To lock I²C as the active serial port, set Bit 1 (I2C_LOCK) of the CONFIG2 register to 1. From this moment, the device ignores spurious toggling of the \overline{SS}/HSA pin, and a switch to the SPI port is no longer possible.

If SPI is the active serial port, any write to the CONFIG2 register locks the port, and a switch to the I²C port is no longer possible. To use the I²C port, the [ADE7854A/ADE7858A/ADE7868A/ADE7878A](#) must be powered down or the device must be reset by setting the **RESET** pin low. After the serial port is locked, the serial port selection is maintained when the device changes from one PSMx power mode to another.

Immediately after entering PSM0 mode, all registers in the [ADE7854A/ADE7858A/ADE7868A/ADE7878A](#) are set to their default values, including the CONFIG2 and LPOILVL registers.

The [ADE7854A/ADE7858A/ADE7868A/ADE7878A](#) signal the end of the transition period by pulling the $\overline{\text{IRQ1}}$ interrupt pin low and setting Bit 15 (RSTDONE) in the STATUS1 register to 1. This bit is cleared to 0 during the transition period and is set to 1 when the transition ends. Writing the STATUS1 register with the RSTDONE bit set to 1 clears the status bit and returns the $\overline{\text{IRQ1}}$ pin high. Because RSTDONE is an unmaskable interrupt, Bit 15 (RSTDONE) in the STATUS1 register must be cancelled for the $\overline{\text{IRQ1}}$ pin to return high. Wait until the $\overline{\text{IRQ1}}$ pin goes low before accessing the STATUS1 register to test the state of the RSTDONE bit. At this point, as a good programming practice, cancel all other status flags in the STATUS1 and STATUS0 registers by writing the corresponding bits with 1.

Initially, the DSP is in idle mode and, therefore, does not execute any instructions. This is the moment to initialize all registers in the [ADE7854A](#), [ADE7858A](#), [ADE7868A](#), or [ADE7878A](#). See the Digital Signal Processor section for the proper procedure to initialize all registers and start the metering.

If the supply voltage, VDD, falls lower than 2.5 V ± 10%, the [ADE7854A/ADE7858A/ADE7868A/ADE7878A](#) enter an inactive state, which means that no measurements or computations are executed.

HARDWARE RESET

The [ADE7854A](#), [ADE7858A](#), [ADE7868A](#), and [ADE7878A](#) have a **RESET** pin. When the [ADE7854A](#), [ADE7858A](#), [ADE7868A](#), or [ADE7878A](#) is in PSM0 mode and the **RESET** pin is set low, the device enters the hardware reset state. The device must be in PSM0 mode to execute a hardware reset. Setting the **RESET** pin low while the device is in PSM1, PSM2, or PSM3 mode has no effect on the device.

When the [ADE7854A](#), [ADE7858A](#), [ADE7868A](#), or [ADE7878A](#) is in PSM0 mode and the $\overline{\text{RESET}}$ pin is toggled from high to low and then back to high after at least 10 μs , all registers are reset to their default values, including the CONFIG2 and LPOILVL registers.

The device signals the end of the transition period by pulling the $\overline{\text{IRQ1}}$ interrupt pin low and setting Bit 15 (RSTDONE) in the STATUS1 register to 1. This bit is cleared to 0 during the transition period and is reset to 1 when the transition ends. Writing to the STATUS1 register with the RSTDONE bit set to 1 clears the status bit and returns the $\overline{\text{IRQ1}}$ pin high.

After a hardware reset, the DSP is in idle mode and, therefore, does not execute any instructions.

Because the I²C port is the default serial port of the [ADE7854A/ADE7858A/ADE7868A/ADE7878A](#), it becomes active after a reset. If the SPI is the port used by the external microprocessor, the procedure to enable it must be repeated immediately after the $\overline{\text{RESET}}$ pin is toggled back to high (for more information, see the Serial Interface Selection section).

After a hardware reset, initialize all registers of the [ADE7854A/ADE7858A/ADE7868A/ADE7878A](#) registers, enable data memory RAM protection, and then write 0x0001 to the run register to start the DSP. For more information about data memory RAM protection and the run register, see the Digital Signal Processor section.

SOFTWARE RESET

Bit 7 (SWRST) in the CONFIG register manages the software reset functionality in PSM0 mode. The default value of this bit is 0. Setting Bit 7 to 1 causes the [ADE7854A/ADE7858A/ADE7868A/ADE7878A](#) to enter the software reset state. In this state, all internal registers except for CONFIG2 and LPOILVL are reset to their default values. The selected serial port, I²C or SPI, remains unchanged if the lock-in procedure was executed (see the Serial Interface Selection section).

When the software reset ends, Bit 7 (SWRST) in the CONFIG register is cleared to 0, the $\overline{\text{IRQ1}}$ interrupt pin is set low, and Bit 15 (RSTDONE) in the STATUS1 register is set to 1. The RSTDONE bit is cleared to 0 during the transition period and is reset to 1 when the transition ends. Writing to the STATUS1 register with the RSTDONE bit set to 1 clears the status bit and resets the $\overline{\text{IRQ1}}$ pin high.

After software reset, the DSP is in idle mode and, therefore, does not execute any instructions. Take the following steps to restart the DSP:

1. Initialize all [ADE7854A/ADE7858A/ADE7868A/ADE7878A](#) registers.
2. Enable the data memory RAM protection.
3. Write 0x0001 to the run register to start the DSP. For more information about data memory RAM protection and the run register, see the Digital Signal Processor section.

The software reset functionality is not available in PSM1, PSM2, or PSM3 mode.

THEORY OF OPERATION

ANALOG INPUTS

The ADE7868A/ADE7878A have seven analog inputs forming current and voltage channels. The ADE7854A/ADE7858A have six analog inputs but the neutral current is removed from these devices.

The current channels consist of four pairs of fully differential voltage inputs: IAP and IAN, IBP and IBN, ICP and ICN, and INP and INN. These voltage input pairs have a maximum differential signal of ± 0.5 V peak. In addition, the maximum signal level on analog inputs for each IxP/IxN pair is ± 0.5 V peak with respect to AGND. The maximum common-mode signal allowed on the inputs is ± 25 mV. Figure 28 shows a schematic of the input for the current channels and their relationship to the maximum common-mode voltage.



Figure 28. Maximum Input Level, Current Channels, Gain = +1

All inputs have a programmable gain amplifier (PGA) with a possible gain selection of 1, 2, 4, 8, or 16. The gain of the IAx, IBx, and ICx inputs is set in Bits[2:0] (PGA1[2:0]) of the gain register. For the ADE7868A and ADE7878A only, the gain of the INx channel input is set in Bits[5:3] (PGA2[2:0]) of the gain register; thus, a different gain from the IAx, IBx, or ICx inputs is possible. See Table 41 for information about the gain register. The voltage channel has three single-ended voltage inputs: VAP, VBP, and VCP. These single-ended voltage inputs have a maximum input voltage of ± 0.5 V with respect to VN. In addition, the maximum signal level on analog inputs for VxP and VN is ± 0.5 V with respect to AGND. The maximum common-mode signal allowed on the inputs is ± 25 mV. See Figure 29 for a schematic of the voltage channel inputs and their relationship to the maximum common-mode voltage.

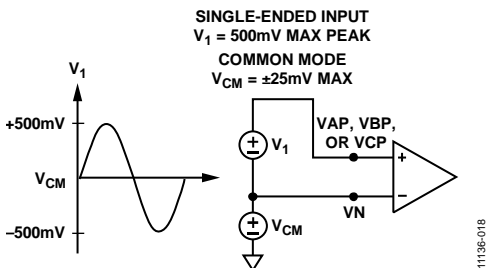

Figure 29. Maximum Input Level, Voltage Channels, Gain = +1

All inputs have a programmable gain with a possible gain selection of 1, 2, 4, 8, or 16. To set the gain, use Bits[8:6] (PGA3[2:0]) in the gain register (see Table 41).

Figure 30 shows how the gain selection from the gain register works in both the current and voltage channels.



Figure 30. PGA in Current and Voltage Channels

ANALOG-TO-DIGITAL CONVERSION

The ADE7868A/ADE7878A have seven Σ - Δ analog-to-digital converters (ADCs), and the ADE7854A/ADE7858A have six Σ - Δ ADCs.

- In PSM0 mode, all ADCs are active.
- In PSM1 mode, only the ADCs that measure the Phase A, Phase B, and Phase C currents are active. The ADCs that measure the neutral current and the A, B, and C phase voltages are turned off.
- In PSM2 and PSM3 modes, the ADCs are powered down to minimize power consumption.

For simplicity, the block diagram in Figure 31 shows a first-order Σ - Δ ADC. The converter is composed of the Σ - Δ modulator and the digital low-pass filter.



Figure 31. First-Order Σ - Δ ADC

The Σ - Δ modulator converts the input signal into a continuous serial stream of 1s and 0s at a rate determined by the sampling clock. In the ADE7854A/ADE7858A/ADE7868A/ADE7878A, the sampling clock is equal to 1.024 MHz (CLKIN/16).

The 1-bit DAC in the feedback loop is driven by the serial data stream. The DAC output is subtracted from the input signal. When the loop gain is high enough, the average value of the DAC output (and, therefore, the bit stream) can approach that of the input signal level. For any given input value in a single sampling interval, the data from the 1-bit ADC is virtually meaningless. Only when a large number of samples are averaged is a meaningful result obtained. This averaging occurs in the second part of the ADC (the digital low-pass filter). By averaging a large number of bits from the modulator, the low-pass filter can produce 24-bit data-words that are proportional to the input signal level.

The Σ - Δ ADC uses two techniques to achieve high resolution from what is essentially a 1-bit conversion technique. The first technique is oversampling. Oversampling means that the signal is sampled at a rate (frequency) that is many times higher than the bandwidth of interest. For example, the sampling rate in the [ADE7854A/ADE7858A/ADE7868A/ADE7878A](#) is 1.024 MHz, and the bandwidth of interest is 40 Hz to 2 kHz.

Oversampling has the effect of spreading the quantization noise (noise due to sampling) over a wider bandwidth. With the noise spread more thinly over a wider bandwidth, the quantization noise in the band of interest lowers, as shown in Figure 32. However, oversampling alone is not efficient enough to improve the signal-to-noise ratio (SNR) in the band of interest. For example, an oversampling factor of 4 is required just to increase the SNR by a mere 6 dB (one bit). To keep the oversampling ratio at a reasonable level, it is possible to shape the quantization noise so that the majority of the noise lies at the higher frequencies.

In the Σ - Δ modulator, the noise is shaped by the integrator, which has a high-pass-type response for the quantization noise. This is the second technique used to achieve high resolution. The result is that most of the noise is at the higher frequencies where the digital low-pass filter removes it. This noise shaping is shown in Figure 32.



Figure 32. Noise Reduction Due to Oversampling and Noise Shaping in the Analog Modulator

Antialiasing Filter

Figure 31 shows an analog low-pass filter (RC) on the input to the ADC. This filter is placed outside the [ADE7854A/ADE7858A/ADE7868A/ADE7878A](#); its role is to prevent aliasing. Aliasing is an artifact of all sampled systems, as shown in Figure 33. Aliasing means that frequency components in the input signal to the ADC, which are higher than half the sampling rate of the ADC, appear in the sampled signal at a frequency below half the sampling rate. Frequency components above half the sampling frequency (also known as the Nyquist frequency, that is, 512 kHz) are imaged or folded back down below 512 kHz. This happens with all ADCs regardless of the architecture. In the example shown, only frequencies near the sampling frequency, that is, 1.024 MHz, move into

the band of interest for metering, that is, 40 Hz to 2 kHz. To attenuate the high frequency noise (near 1.024 MHz) and prevent the distortion of the band of interest, a low-pass filter (LPF) must be introduced.

For conventional current sensors, use one RC filter with a corner frequency of 5 kHz to achieve sufficiently high attenuation at the sampling frequency of 1.024 MHz. The 20 dB per decade attenuation of this filter is usually sufficient to eliminate the effects of aliasing for conventional current sensors. However, for a di/dt sensor, such as a Rogowski coil, the sensor has a 20 dB per decade gain. This neutralizes the 20 dB per decade attenuation produced by the LPF. Therefore, when using a di/dt sensor, take care to offset the 20 dB per decade gain. One simple approach is to cascade one additional RC filter, thereby producing a -40 dB per decade attenuation.



Figure 33. Aliasing Effects

ADC Transfer Function

All ADCs in the [ADE7854A/ADE7858A/ADE7868A/ADE7878A](#) are designed to produce the same 24-bit signed output code for the same input signal level. With a full-scale input signal of 0.5 V and an internal reference of 1.2 V, the ADC output code is nominally 5,928,256 (0x5A7540). The code from the ADC can vary between 0x800000 (-8,388,608) and 0x7FFFFFFF (+8,388,607); this is equivalent to an input signal level of ± 0.707 V. However, for specified performance, do not exceed the nominal range of ± 0.5 V peak; ADC performance is guaranteed only for input signals lower than ± 0.5 V peak.

CURRENT CHANNEL ADC

Figure 35 shows the ADC and signal processing path for the IA current channel. It is the same for the IB and IC current channels. The ADC outputs are signed, twos complement, 24-bit data-words and are available at a rate of 8 kSPS (thousand samples per second). With the specified full-scale analog input signal of ± 0.5 V peak, the ADC produces its maximum output code value; the ADC output swings between -5,928,256 (0xA58AC0) and +5,928,256 (0x5A7540). Figure 35 shows a full-scale voltage signal applied to the differential inputs (IAP and IAN). The IN current channel corresponds to the neutral current of a 3-phase system (available in the [ADE7868A](#) and [ADE7878A](#) only). If no neutral line is present, connect this input to AGND. The datapath of the neutral current is similar to the path of the phase currents (see Figure 36).

Current Waveform Gain Registers

There is a multiplier in the signal path of each phase and neutral current. The current waveform can be changed by ±100% by writing a corresponding two's complement number to the 24-bit signed current waveform gain registers (AIGAIN, BIGAIN, CIGAIN, and NIGAIN). For example, writing 0x400000 to the xIGAIN registers scales up the ADC output by 50%. To scale the input by -50%, write 0xC00000 to these registers. Equation 3 describes mathematically the function of the current waveform gain registers.

$$\text{Current Waveform} = \text{ADC Output} \times \left(1 + \frac{\text{Contents of Current Gain Register}}{2^{23}} \right) \quad (3)$$

Changing the content of the AIGAIN, BIGAIN, CIGAIN, or NIGAIN register affects all calculations based on the current of

each of these registers; that is, it affects the corresponding phase active/reactive/apparent energy and current rms calculation. In addition, waveform samples scale accordingly.

Note that the serial ports of the ADE7854A, ADE7858A, ADE7868A, and ADE7878A work on 32-, 16-, or 8-bit words, and the DSP works on 28 bits. The 24-bit AIGAIN, BIGAIN, CIGAIN, and NIGAIN registers are accessed as 32-bit registers with the four most significant bits (MSBs) padded with 0s and sign extended to 28 bits (see Figure 34).

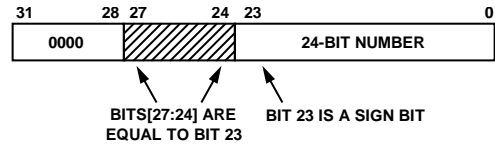

Figure 34. 24-Bit xIGAIN Registers Transmitted as 32-Bit Words



Figure 35. Phase Current Signal Path

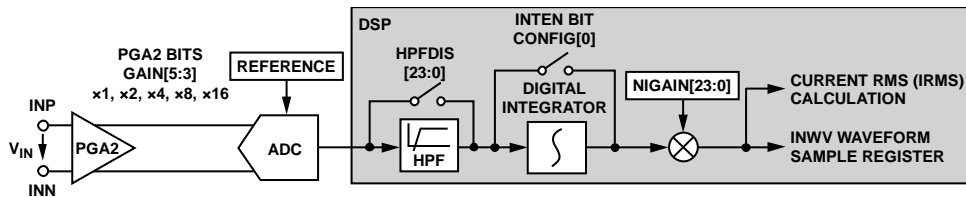

Figure 36. Neutral Current Signal Path (ADE7868A and ADE7878A Only)

Current Channel High-Pass Filter

The ADC outputs can contain a dc offset. This offset may create errors in power and rms calculations. High-pass filters (HPFs) are placed in the signal path of the phase and neutral currents and of the phase voltages. When enabled, the HPF eliminates any dc offset on the current channel. All filters are implemented in the DSP and, by default, they are all enabled: the 24-bit HPFDIS register is cleared to 0x000000. Disable all filters by setting HPFDIS to any nonzero value.

As stated in the Current Waveform Gain Registers section, the serial ports of the ADE7854A, ADE7858A, ADE7868A, and ADE7878A work on 32-, 16-, or 8-bit words. The HPFDIS register is accessed as a 32-bit register with eight MSBs padded with 0s (see Figure 37).

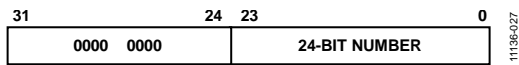

Figure 37. 24-Bit HPFDIS Register Transmitted as a 32-Bit Word

Current Channel Sampling

The waveform samples of the current channel are taken at the output of the HPF at a rate of 8 kSPS and stored in the 24-bit signed registers, IAWV, IBWV, ICWV, and INWV (ADE7868A and ADE7878A only). All power and rms calculations remain uninterrupted during this process. Bit 17 (DREADY) in the STATUS0 register is set when the IAWV, IBWV, ICWV, and INWV registers are available to be read using the I²C or SPI serial port. Setting Bit 17 (DREADY) in the MASK0 register enables an interrupt to be set when the DREADY flag is set. See the Digital Signal Processor section for more information about the DREADY bit.

As stated in the Current Waveform Gain Registers section, the serial ports of the ADE7854A/ADE7858A/ADE7868A/ADE7878A work on 32-, 16-, or 8-bit words. When the IAWV, IBWV, ICWV, and INWV 24-bit signed registers are read from the device (INWV is available on ADE7868A/ADE7878A only), they are transmitted sign extended to 32 bits (see Figure 38).

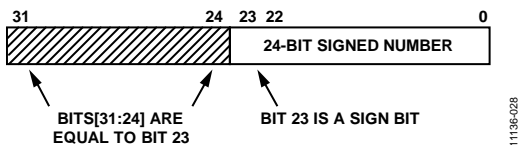

Figure 38. 24-Bit IxWV Registers Transmitted as 32-Bit Signed Words

The ADE7854A/ADE7858A/ADE7868A/ADE7878A contain a high speed data capture (HSDC) port that is specially designed to provide fast access to the waveform sample registers. For more information, see the HSDC Interface section.

di/dt CURRENT SENSOR AND DIGITAL INTEGRATOR

The di/dt sensor detects changes in the magnetic field caused by the ac current. Figure 39 shows the principle of a di/dt current sensor.

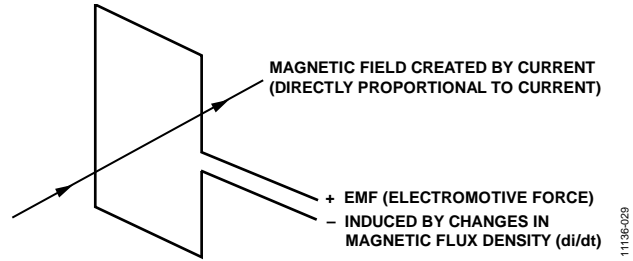

Figure 39. Principle of a di/dt Current Sensor

The flux density of a magnetic field induced by a current is directly proportional to the magnitude of the current. The changes in the magnetic flux density passing through a conductor loop generate an electromotive force (EMF) between the two ends of the loop. The EMF is a voltage signal that is proportional to the di/dt of the current. The mutual inductance between the current carrying conductor and the di/dt sensor determine the voltage output from the di/dt current sensor.

The di/dt sensor requires filtering of the current signal before using it for power measurement. On each phase and neutral current datapath, there is a built-in digital integrator to recover the current signal from the di/dt sensor. The digital integrator is disabled by default when the ADE7854A/ADE7858A/ADE7868A/ADE7878A are powered up and after a reset. Setting Bit 0 (INTEN) of the CONFIG register turns on the integrator. Figure 40 and Figure 41 show the magnitude and phase response of the digital integrator.

Note that the integrator has a -20 dB/dec attenuation and an approximately -90° phase shift. When combined with a di/dt sensor, the resulting magnitude and phase response should be a flat gain over the frequency band of interest. However, the di/dt sensor has a 20 dB/dec gain associated with it, and it generates significant high frequency noise. An antialiasing filter of at least the second order is required to avoid noise aliasing back in the band of interest when the ADC is sampling (see the Antialiasing Filter section).

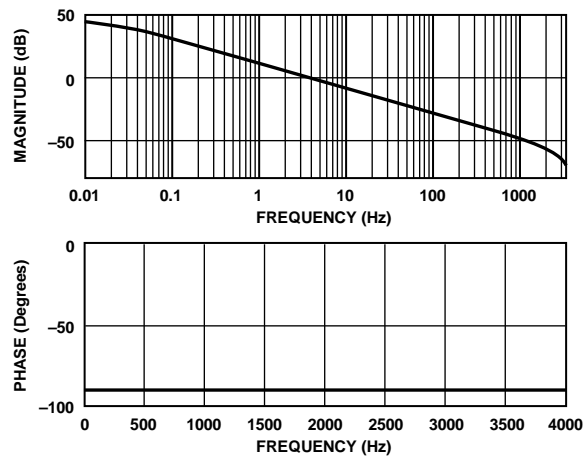

Figure 40. Combined Gain and Phase Response of the Digital Integrator

The digital integrator algorithm uses the DICOEFF 24-bit signed register. At power-up or after a reset, its value is 0x000000. Before turning on the integrator, it is necessary to initialize this register with 0xFFFF8000. When the integrator is turned off, DICOEFF is not used and can remain at 0x000000.

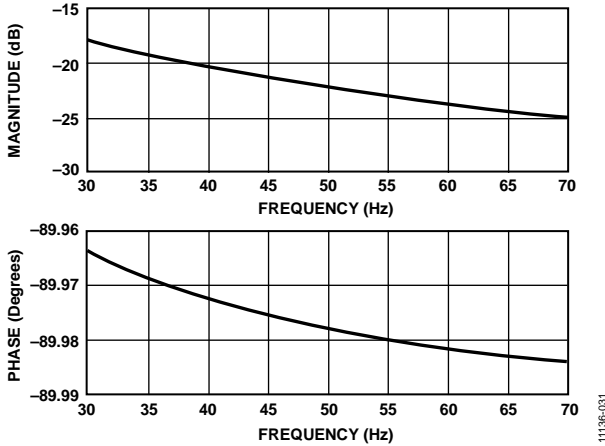

Figure 41. Combined Gain and Phase Response of the Digital Integrator (40 Hz to 70 Hz)

As stated in the Current Waveform Gain Registers section, the serial ports of the device work on 32-, 16-, or 8-bit words. Similar to the registers shown in Figure 34, the DICOEFF 24-bit signed register is accessed as a 32-bit register with four MSBs padded with 0s; thus, the 24-bit word is sign extended to 28 bits, meaning that it is practically transmitted equal to 0xFFFF8000.

When the digital integrator is switched off, the ADE7854A/ADE7858A/ADE7868A/ADE7878A can be used directly with a conventional current sensor, such as a current transformer (CT).

VOLTAGE CHANNEL ADC

Figure 42 shows the ADC and signal processing chain for the VA voltage channel. The VB and VC voltage channels have similar processing chains. The ADC outputs are signed, two's complement, 24-bit words and are available at a rate of 8 kSPS. With the specified full-scale analog input signal of ±0.5 V peak, the ADC produces its maximum output code value. Figure 42 shows a full-scale voltage signal applied to the differential inputs (VAX and VN); the ADC output swings between -5,928,256 (0xA58AC0) and +5,928,256 (0x5A7540).

Voltage Waveform Gain Registers

There is a multiplier in the signal path of each phase voltage. To change the voltage waveform by ±100%, write a corresponding two's complement number to the 24-bit signed voltage waveform gain registers (AVGAIN, BVGAIN, and CVGAIN). For example, writing 0x400000 to those registers scales up the ADC output by 50%. To scale the input by -50%, write 0xC00000 to the registers. Equation 4 describes the function of the current waveform gain registers.

$$\text{Voltage Waveform} = \text{ADC Output} \times \left(1 + \frac{\text{Contents of Voltage Gain Register}}{2^{23}} \right) \quad (4)$$

Changing the content of the AVGAIN, BVGAIN, and CVGAIN registers affects all calculations based on its voltage; that is, it affects the corresponding phase active/reactive/apparent energy and voltage rms calculation, and waveform samples are scaled accordingly.

As stated in the Current Waveform Gain Registers section, the serial ports of the device work on 32-, 16-, or 8-bit words, and the DSP works on 28 bits. As shown in Figure 34, the AVGAIN, BVGAIN, and CVGAIN registers are accessed as 32-bit registers with four MSBs padded with 0s and sign extended to 28 bits.

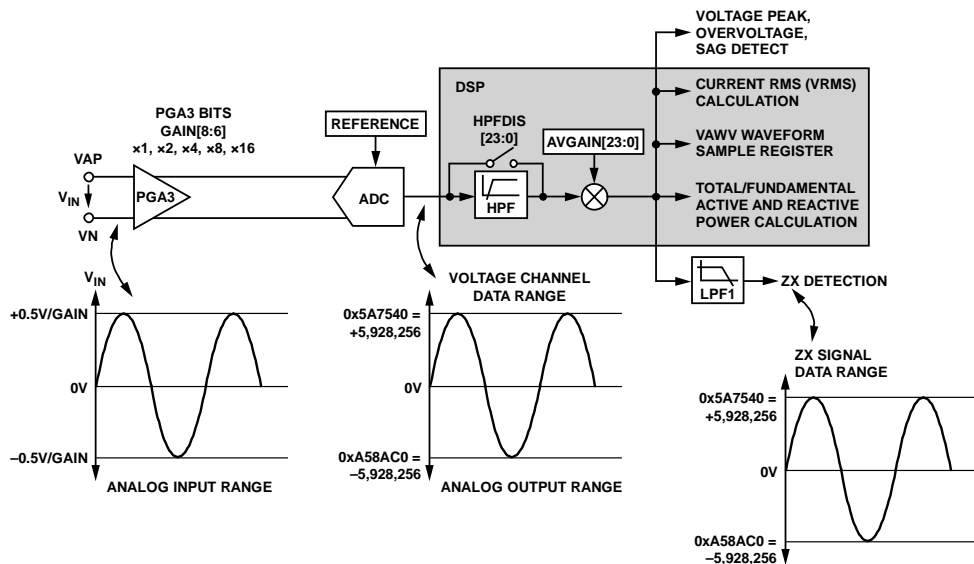

Figure 42. Voltage Channel Datapath

Voltage Channel HPF

As explained in the Current Channel High-Pass section, the ADC outputs can contain a dc offset that can create errors in power and rms calculations. HPFs are placed in the signal path of the phase voltages, similar to the ones in the current channels. The HPFDIS register enables or disables the filters. See the Current Channel High-Pass section for more information.

Voltage Channel Sampling

The waveform samples of the voltage channel are taken at the output of the HPF at a rate of 8 kSPS and stored into VAWV, VBWV, and VCWV 24-bit signed registers. All power and rms calculations remain uninterrupted during this process. Bit 17 (DREADY) in the STATUS0 register is set when the VAWV, VBWV, and VCWV registers are available to be read using the I²C or SPI serial port. Setting Bit 17 (DREADY) in the MASK0 register enables an interrupt to be set when the DREADY flag is set. For more information about the DREADY bit, see the Digital Signal Processor section.

As stated in the Current Waveform Gain Registers section, the serial ports of the ADE7854A/ADE7858A/ADE7868A/ADE7878A work on 32-, 16-, or 8-bit words. Similar to the registers shown in Figure 38, the VAWV, VBWV, and VCWV 24-bit signed registers are transmitted sign extended to 32 bits.

The ADE7854A/ADE7858A/ADE7868A/ADE7878A each contain an HSDC port especially designed to provide fast access to the waveform sample registers. See the HSDC Interface section for more information.

CHANGING THE PHASE VOLTAGE DATAPATH

The ADE7854A/ADE7858A/ADE7868A/ADE7878A can direct one phase voltage input to the computational datapath of another phase. For example, Phase A voltage can be introduced in the Phase B computational datapath, which means all powers computed by the ADE7854A/ADE7858A/ADE7868A/ADE7878A in Phase B are based on Phase A voltage and Phase B current.

Bits[9:8] (VTOIA[1:0]) of the CONFIG register manage what phase voltage is directed to Phase A computational data path. If VTOIA[1:0] = 00 (default value), the Phase A voltage is directed to the Phase A computational data path. If VTOIA[1:0] = 01, the Phase B voltage is directed to the Phase A computational data path. If VTOIA[1:0] = 10, the Phase C voltage is directed to the Phase A computational data path. If VTOIA[1:0] = 11, the ADE7854A/ADE7858A/ADE7868A/ADE7878A behave as if VTOIA[1:0] = 00.

Bits[11:10] (VTOIB[1:0]) of the CONFIG register manage what phase voltage is directed to the Phase B computational data path. If VTOIB[1:0] = 00 (default value), the Phase B voltage is directed to the Phase B computational data path. If VTOIB[1:0] = 01, the Phase C voltage is directed to the Phase B computational data path. If VTOIB[1:0] = 10, the Phase A voltage is directed to the Phase B computational data path.

VTOIB[1:0] = 11, the ADE7854A/ADE7858A/ADE7868A/ADE7878A behave as if VTOIB[1:0] = 00.

Bits[13:12] (VTOIC[1:0]) of the CONFIG register manage what phase voltage is directed to the Phase C computational data path. If VTOIC[1:0] = 00 (default value), the Phase C voltage is directed to Phase C computational data path, if VTOIC[1:0] = 01, the Phase A voltage is directed to the Phase C computational data path. If VTOIC[1:0] = 10, the Phase B voltage is directed to the Phase C computational data path. If VTOIC[1:0] = 11, the ADE7854A/ADE7858A/ADE7868A/ADE7878A behave as if VTOIC[1:0] = 00.

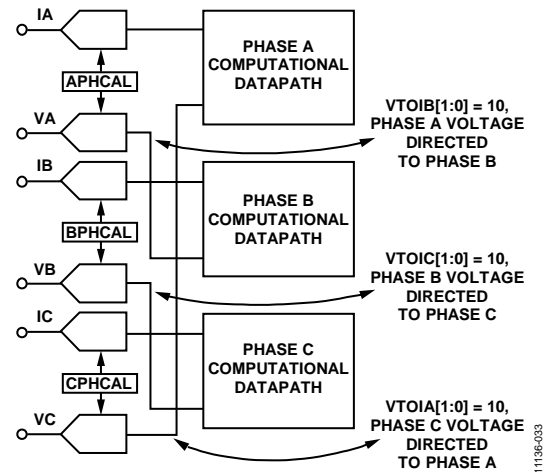

Figure 43. Phase Voltages Used in Different Datapaths

Figure 43 presents the case in which Phase A voltage is used in the Phase B datapath, phase B voltage is used in the Phase C datapath, and phase C voltage is used in the phase A datapath.

POWER QUALITY MEASUREMENTS

Zero-Crossing Detection

The ADE7854A/ADE7858A/ADE7868A/ADE7878A have a zero-crossing (ZX) detection circuit on the phase current and voltage channels. The neutral current datapath does not contain a zero-crossing detection circuit. Zero-crossing events serve as a time base for various power quality measurements and in the calibration process.

The output of LPF1 generates zero-crossing events. The low-pass filter eliminates all harmonics of 50 Hz and 60 Hz systems, and helps identify the zero-crossing events on the fundamental components of both current and voltage channels.

The digital filter has a pole at 80 Hz and is clocked at 256 kHz. As a result, there is a phase lag between the analog input signal (one of each pair of IA, IB, IC, VA, VB, and VC signals) and the output of LPF1. The error in ZX detection is 0.0703° for 50 Hz systems (0.0843° for 60 Hz systems). The phase lag response of LPF1 results in a time delay of approximately 31.4° or 1.74 ms (at 50 Hz) between its input and output. The overall delay between the zero crossing on the analog inputs and ZX detection obtained after LPF1 is about 39.6° or 2.2 ms (at 50 Hz). The ADC and HPF introduce the additional delay. To assure good

resolution of the ZX detection, the LPF1 cannot be disabled. Figure 45 shows how the zero-crossing signal is detected.

To provide further protection from noise, input signals to the voltage channel with amplitude lower than 10% of full scale do not generate zero-crossing events at all. The Current Channel ZX detection circuit is active for all input signals independent of their amplitudes.

The ADE7854A/ADE7858A/ADE7868A/ADE7878A contain six zero-crossing detection circuits, one for each phase voltage and current channel. Each circuit drives one flag in the STATUS1 register. If a circuit placed in the Phase A voltage channel detects one zero-crossing event, Bit 9 (ZXVA) in the STATUS1 register is set to 1.

Similarly, the Phase B voltage circuit drives Bit 10 (ZXVB), the Phase C voltage circuit drives Bit 11 (ZXVC), and circuits placed in the current channel drive Bit 12 (ZXIA), Bit 13 (ZXIB), and Bit 14 (ZXIC) in the STATUS1 register. If a ZX detection bit is set in the MASK1 register, the IRQ1 interrupt pin is driven low and the corresponding status flag is set to 1. The status bit is cleared and the IRQ1 pin is set to high by writing to the STATUS1 register with the status bit set to 1.

Zero-Crossing Timeout

Every zero-crossing detection circuit has an associated timeout register. This register is loaded with the value written into the 16-bit ZXTOUT register and is decremented (1 LSB) every 62.5 μs (16 kHz clock). Every time a zero crossing is detected, the register resets to the ZXTOUT value. The default value of this register is 0xFFFF. If the timeout register decrements to 0 before a zero crossing is detected, one of Bits[8:3] of the STATUS1 register is set to 1. Bit 3 (ZXTOVA), Bit 4 (ZXTOVB), and Bit 5 (ZXTOVC) in the STATUS1 register refer to Phase A, Phase B, and Phase C of the voltage channel; Bit 6 (ZXTOIA),

Bit 7 (ZXTOIB), and Bit 8 (ZXTOIC) in the STATUS1 register refer to Phase A, Phase B, and Phase C of the current channel.

Setting a ZXTOIx or ZXTOVx bit in the MASK1 register drives the IRQ1 interrupt pin low when the corresponding status bit is set to 1. Writing to the STATUS1 register with the status bit set to 1 clears the status bit and returns the IRQ1 pin to high.

The resolution of the ZXTOUT register is 62.5 μs (16 kHz clock) per LSB. Thus, the maximum timeout period for an interrupt is 4.096 sec: $2^{16}/16$ kHz.

Figure 44 shows the mechanism of the zero-crossing timeout detection when the voltage or the current signal stays at a fixed dc level for more than $62.5 \mu s \times ZXTOUT \mu s$.



Figure 44. Zero-Crossing Timeout Detection

11136-035



Figure 45. Zero-Crossing Detection on Voltage and Current Channels

11136-034

Phase Sequence Detection

The ADE7854A/ADE7858A/ADE7868A/ADE7878A have on-chip phase sequence error detection circuits. This detection works on phase voltages and considers only the zero crossings determined by their negative to positive transitions.

The regular succession of these zero-crossing events is Phase A followed by Phase B followed by Phase C (see Figure 47). If the sequence of zero-crossing events is, instead, Phase A followed by Phase C followed by Phase B, then Bit 19 (SEQERR) in the STATUS1 register is set.

Setting Bit 19 (SEQERR) in the MASK1 register to 1 and triggering a phase sequence error event drives the IRQ1 interrupt pin low. Writing to the STATUS1 register with Bit 19 (SEQERR) set to 1 clears the status bit and sets the IRQ1 pin to high.

The phase sequence error detection circuit is functional only when the device is connected in a 3-phase, 4-wire, three-voltage sensor configuration (Bits[5:4], CONSEL[1:0] in the ACCMODE register, set to 00). In all other configurations, only two voltage sensors are used; therefore, do not use the detection circuit in these cases. Instead, use the time intervals between phase voltages to analyze the phase sequence (see the Time Interval Between Phases section).

Figure 46 presents the case in which Phase A voltage is not followed by Phase B voltage; rather, Phase A voltage is followed by Phase C voltage. Each time a negative to positive zero crossing occurs, Bit 19 (SEQERR) in the STATUS1 register is set to 1 because zero crossings on Phase C, Phase B, or Phase A cannot follow zero crossings from Phase A, Phase C, or Phase B, respectively.



Figure 46. SEQERR Bit Set to 1 When Phase A Voltage Is Followed by Phase C Voltage

When a phase sequence error is detected, the time measurement between various phase voltages (see the Time Interval Between Phases section) can help to identify which phase voltage is to be considered with another phase current in the computational datapath. Use Bits[9:8] (VTOIA[1:0]), Bits[11:10] (VTOIB[1:0]), and Bits[13:12] (VTOIC[1:0]) in the CONFIG register to direct one phase voltage to the datapath of another phase. See the

Changing the Phase Voltage Datapath section for more information.

Time Interval Between Phases

The ADE7854A/ADE7858A/ADE7868A/ADE7878A are capable of measuring the time delay between phase voltages, between phase currents, or between voltages and currents of the same phase. The negative to positive transitions identified by the zero-crossing detection circuit serve as start and stop measuring points. Only one set of such measurements is available at one time based on Bits[10:9] (ANGLESEL[1:0]) in the COMPMODE register.



Figure 47. Regular Succession of Phase A, Phase B, and Phase C

Delays Between Voltages and Currents

To measure the delays between voltages and currents on the same phase, set the ANGLESEL[1:0] bits to 00, the default value. The delay between Phase A voltage and Phase A current is stored in the 16-bit unsigned ANGLE0 register (see Figure 48). In a similar way, the delays between voltages and currents on Phase B and Phase C are stored in the ANGLE1 and ANGLE2 registers, respectively.



Figure 48. Delay Between Phase A Voltage and Phase A Current Is Stored in the ANGLE0 Register

Delays Between Phase Voltages

To measure the delays between phase voltages, set the ANGLESEL[1:0] bits to 01. The delay between the Phase A voltage and the Phase C voltage is stored in the ANGLE0 register. The delay between Phase B voltage and Phase C voltage is stored in the ANGLE1 register, and the delay between Phase A voltage and Phase B voltage is stored in the ANGLE2 register (see Figure 49).

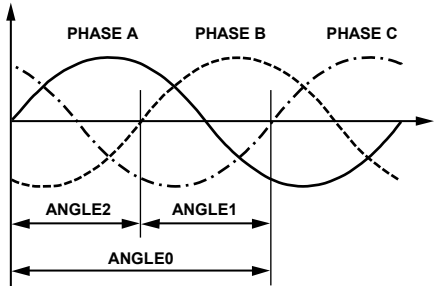

Figure 49. Delays Between Phase Voltages (Currents)

Delays Between Phase Currents

To measure the delays between phase currents, set the ANGLE-SEL[1:0] bits to 10. Similar to delays between phase voltages, the delay between Phase A and Phase C currents is stored into the ANGLE0 register, the delay between Phase B and Phase C currents is stored in the ANGLE1 register, and the delay between Phase A and Phase B currents is stored into the ANGLE2 register (see Figure 49).

Power Factor

The ANGLE0, ANGLE1, and ANGLE2 registers are 16-bit unsigned registers with 1 LSB corresponding to 3.90625 μs (256 kHz clock), which means a resolution of 0.0703° (360° × 50 Hz/256 kHz) for 50 Hz systems and 0.0843° (360° × 60 Hz/256 kHz) for 60 Hz systems. The delays between phase voltages or phase currents characterize the balance of the load. The delays between phase voltages and currents are used to compute the power factor on each phase, as shown in Equation 5.

$$\cos\phi_x = \cos \left[ANGLE_x \times \frac{360^\circ \times f_{LINE}}{256 \text{ kHz}} \right] \quad (5)$$

where f_{LINE} = 50 Hz or 60 Hz.

Period Measurement

The ADE7854A/ADE7858A/ADE7868A/ADE7878A provide the period measurement of the line in the voltage channel. Bits[1:0] (PERSEL[1:0]) in the MMODE register select the phase voltage that is used for this measurement. The period register is a 16-bit unsigned register that updates every line period. Because of the LPF1 filter (see Figure 45), a settling time of 30 ms to 40 ms is associated with this filter before the measurement is stable.

The period measurement has a resolution of 3.90625 μs/LSB (256 kHz clock), which represents 0.0195% (50 Hz/256 kHz) when the line frequency is 50 Hz and 0.0234% (60 Hz/256 kHz) when the line frequency is 60 Hz. The value of the period register for 50 Hz networks is approximately 5120 (256 kHz/50 Hz) and for 60 Hz networks is approximately 4267 (256 kHz/60 Hz). The length of the register enables the measurement of line frequencies as low as 3.9 Hz (256 kHz/2¹⁶). The period register is stable at ±1 LSB when the line is established and the measurement does not change.

The following expressions can be used to compute the line period and frequency using the period register:

$$T_L = \frac{PERIOD[15:0] + 1}{256 \times 10^3} [\text{sec}] \quad (6)$$

$$f_L = \frac{256 \times 10^3}{PERIOD[15:0] + 1} [\text{Hz}] \quad (7)$$

Phase Voltage Sag Detection

The ADE7854A/ADE7858A/ADE7868A/ADE7878A can be programmed to detect when the absolute value of any phase voltage drops below a certain peak value for a number of half line cycles.

The phase where this event takes place is identified in Bits[14:12] (VSPHASE[x]) of the PHSTATUS register. See Figure 50 for an example of this condition.

Figure 50 shows Phase A voltage falling below a threshold that is set in the sag level register (SAGLVL) for four half line cycles (SAGCYC = 4). When Bit 16 (sag) in the STATUS1 register is set to 1 to indicate the condition, Bit VSPHASE[0] in the PHSTATUS register is also set to 1 because the event happened on Phase A. All Bits[14:12] (VSPHASE[2], VSPHASE[1], and VSPHASE[0]) of the PHSTATUS register (not just the VSPHASE[0] bit) are erased by writing to the STATUS1 register with the sag bit set to 1.



Figure 50. Sag Detection

The SAGCYC register represents the number of half line cycles that the phase voltage must remain below the level indicated in the SAGLVL register to trigger a sag condition; 0 is not a valid number for SAGCYC. For example, when the sag cycle (SAGCYC[7:0]) contains 0x07, the sag flag in the STATUS1 register is set at the end of the seventh half line cycle for which the line voltage falls below the threshold. If Bit 16 (sag) in MASK1 is set, the $\overline{\text{IRQ1}}$ interrupt pin is driven low during a sag event at the same moment Status Bit 16 (sag) in the STATUS1 register is set to 1. Writing to the STATUS1 register with the status bit set to 1 clears the sag status bit in the STATUS1 register, clears Bits[14:12] (VSPHASE[2], VSPHASE[1], and VSPHASE[0]) of the PHSTATUS register, and returns the $\overline{\text{IRQ1}}$ pin to high.

When the Phase B voltage falls below the indicated threshold in the SAGLVL register for two line cycles, Bit VSPHASE[1] in the PHSTATUS register is set to 1 and Bit VSPHASE[0] clears to 0. Simultaneously, Bit 16 (sag) in the STATUS1 register is set to 1 to indicate the condition.

Note that the internal zero-crossing counter is always active. By setting the SAGLVL register, the first sag detection result does not execute across a full SAGCYC period. Initializing the SAGLVL prior to writing to the SAGCYC register resets the zero-crossing counter, thus ensuring that the first sag detection result is obtained across a full SAGCYC period.

To manage sag events, follow these steps:

1. Enable sag interrupts in the MASK1 register by setting Bit 16 (sag) to 1.
2. When a sag event happens and the $\overline{\text{IRQ1}}$ interrupt pin goes low, Bit 16 (sag) in the STATUS1 register is set to 1.
3. Read the STATUS1 register with Bit 16 (sag) set to 1.
4. Read the PHSTATUS register to identify on which phase or phases a sag event happened.
5. Write the STATUS1 register with Bit 16 (sag) set to 1 to immediately erase the sag bit and Bits[14:12] (VSPHASE[2], VSPHASE[1], and VSPHASE[0]) of the PHSTATUS register.

Sag Level Set

The content of the SAGLVL[23:0] sag level register is compared to the absolute value of the output from the HPF. Writing 5,928,256 (0x5A7540) to the SAGLVL register sets the sag detection level at full scale (see the Voltage Channel ADC section); thus, the sag event triggers continuously. Writing 0x00 or 0x01 sets the sag detection level to 0; consequently, the sag event never triggers.

The serial ports of the ADE7854A/ADE7858A/ADE7868A/ADE7878A work on 32-, 16-, or 8-bit words (see the Current Waveform Gain Registers section). Similar to the register shown in Figure 37, the SAGLVL register is accessed as a 32-bit register with eight MSBs padded with 0s.

Peak Detection

The ADE7854A/ADE7858A/ADE7868A/ADE7878A record the maximum absolute values reached by the voltage and current channels over a certain number of half line cycles and store them into the least significant 24 bits of the VPEAK and IPEAK 32-bit registers.

The PEAKCYC register contains the number of half line cycles used as a time base for the measurement. The circuit uses the zero-crossing points identified by the zero-crossing detection circuit. Bits[4:2] (PEAKSEL[2:0]) in the MMODE register select the phases upon which the peak measurement is performed. Bit 2 selects Phase A, Bit 3 selects Phase B, and Bit 4 selects Phase C. Selecting more than one phase to monitor the peak values proportionally decreases the measurement period indicated in the PEAKCYC register because zero crossings from more phases are involved in the process.

When a new peak value is determined, one of the Bits[26:24] (IPPHASE[2:0] or VPPHASE[2:0]) in the IPEAK and VPEAK registers is set to 1, identifying the phase that triggered the peak detection event. For example, if a peak value is identified on Phase A current, Bit 24 (IPPHASE[0]) in the IPEAK register is set to 1. If the next time, a new peak value is measured on Phase B, Bit 24 (IPPHASE[0]) of the IPEAK register is cleared to 0, and Bit 25 (IPPHASE[1]) of the IPEAK register is set to 1. Figure 51 shows the composition of the IPEAK and VPEAK registers.



Figure 51. Composition of IPEAK[31:0] and VPEAK[31:0] Registers

Figure 52 shows how the ADE7854A, ADE7858A, ADE7868A, and ADE7878A record the peak value on the current channel when measurements on Phase A and Phase B are enabled (the PEAKSEL[2:0] bits in the MMODE register are 011). The PEAKCYC register is set to 16, meaning that the peak measurement cycle is four line periods.

The maximum absolute value of Phase A is the greatest during the first four line periods (PEAKCYC = 16); therefore, the maximum absolute value is written into the least significant 24 bits of the IPEAK register, and Bit 24 (IPPHASE[0]) of the IPEAK register is set to 1 at the end of the period. This bit remains at 1 for the duration of the second PEAKCYC period of four line cycles.

The maximum absolute value of Phase B is the greatest during the second PEAKCYC period; therefore, the maximum absolute value is written into the least significant 24 bits of the IPEAK register, and Bit 25 (IPPHASE[1]) in the IPEAK register is set to 1 at the end of the period.

At the end of the peak detection period in the current channel, Bit 23 (PKI) in the STATUS1 register is set to 1. If Bit 23 (PKI) in the MASK1 register is set, the $\overline{\text{IRQ1}}$ interrupt pin is driven low at the end of PEAKCYC period and Status Bit 23 (PKI) in the STATUS1 register is set to 1. In a similar way, at the end of the peak detection period in the voltage channel, Bit 24 (PKV) in the STATUS1 register is set to 1. If Bit 24 (PKV) in the MASK1 register is set, the $\overline{\text{IRQ1}}$ interrupt pin is driven low at the end of PEAKCYC period and Status Bit 24 (PKV) in the STATUS1 register is set to 1. To find the phase that triggered the interrupt, one of either the IPEAK or VPEAK registers is read immediately after reading the STATUS1 register. Next, the status bits are cleared and the $\overline{\text{IRQ1}}$ pin is set to high by writing to the STATUS1 register with the status bit set to 1.

Note that the internal zero-crossing counter is always active. By setting Bits[4:2] (PEAKSEL[2:0]) in the MMODE register, the first peak detection result is not executed across a full PEAKCYC period. Writing to the PEAKCYC register when the PEAKSEL[2:0] bits are set resets the zero-crossing counter, thereby ensuring that the first peak detection result is obtained across a full PEAKCYC period.



Figure 52. Peak Level Detection

Overvoltage and Overcurrent Detection

The ADE7854A/ADE7858A/ADE7868A/ADE7878A detect when the instantaneous absolute value measured on the voltage and current channels becomes greater than the thresholds set in the OVLVL and OILVL 24-bit unsigned registers.

Setting Bit 18 (OV) in the MASK1 register drives the $\overline{\text{IRQ1}}$ interrupt pin low during an overvoltage event. There are two status flags set when the $\overline{\text{IRQ1}}$ interrupt pin is driven low. The first flag is set by Bit 18 (OV) in the STATUS1 register and the second flag is set by one of the Bits[11:9] (OVPHASE[2:0]) in

the PHSTATUS register to identify the phase that generated the overvoltage.

Next, Bit 18 (OV) in the STATUS1 register and all Bits[11:9] (OVPHASE[2:0]) in the PHSTATUS register are cleared. Set the $\overline{\text{IRQ1}}$ pin to high by writing to the STATUS1 register with the status bit set to 1. See Figure 53 for overvoltage detection in Phase A voltage.

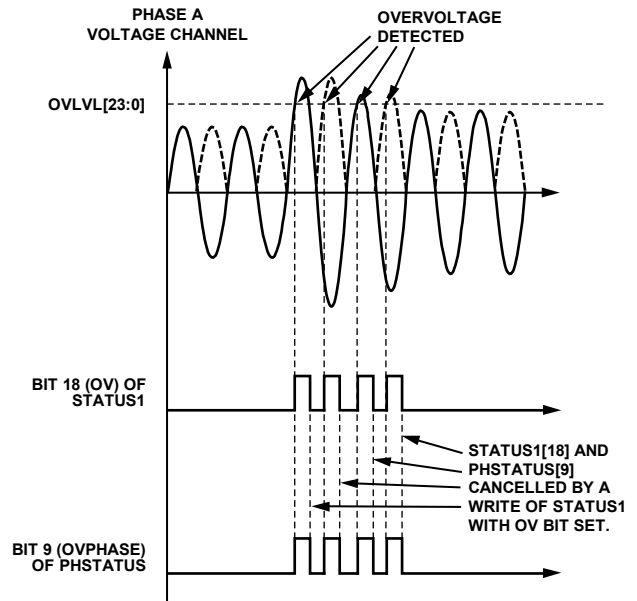

Figure 53. Overvoltage Detection, Phase A

When the absolute instantaneous value of the voltage rises above the threshold from the OVLVL register, Bit 18 (OV) in the STATUS1 register and Bit 9 (OVPHASE[0]) in the PHSTATUS register are set to 1. Writing the STATUS1 register with Bit 18 (OV) set to 1 cancels Bit 18 (OV) of the STATUS1 register and Bit 9 (OVPHASE[0]) in the PHSTATUS register. The procedure to manage overvoltage events is as follows:

1. Enable OV interrupts in the MASK1 register by setting Bit 18 (OV) to 1.
2. When an overvoltage event happens, the $\overline{\text{IRQ1}}$ interrupt pin goes low.
3. The STATUS1 register is read with Bit 18 (OV) set to 1.
4. The PHSTATUS register is read, identifying on which phase or phases an overvoltage event happened.
5. The STATUS1 register is written with Bit 18 (OV) set to 1, immediately erasing Bit OV and Bits[11:9] (OVPHASE[2:0]) of the PHSTATUS register.

In case of an overcurrent event, if Bit 17 (OI) in the MASK1 register is set, the $\overline{\text{IRQ1}}$ interrupt pin is driven low. Immediately thereafter, Bit 17 (OI) in the STATUS1 register is set and one of the Bits[5:3] (OIPHASE[2:0]) in the PHSTATUS register is also set, which internally identifies the phase that generated the interrupt.

To find the phase that triggered the interrupt

1. Read the STATUS1 register and then immediately read the PHSTATUS register.
2. Clear Status Bit 17 (OI) in the STATUS1 register and clear Bits[5:3] (OIPHASE[2:0]) in the PHSTATUS register.
3. Set the IRQ1 pin to high by writing to the STATUS1 register with the status bit set to 1.

Note that overvoltage detection uses a similar process.

Overvoltage and Overcurrent Level Set

The content of the overvoltage (OVLVL) and overcurrent (OILVL) 24-bit unsigned registers is compared to the absolute value of the voltage and current channels. The maximum value of these registers is the maximum value of the HPF outputs, that is, 5,928,256 (0x5A7540); an overvoltage or overcurrent condition is never detected when either the OVLVL or OILVL register is equal to this value. Writing 0x0 to these registers signifies continuous detection for overvoltage and overcurrent conditions, permanently triggering the corresponding interrupts.

As stated in the Current Waveform Gain Registers section, the serial ports of the device work on 32-, 16-, or 8-bit words. Similar to the register presented in Figure 37, the OILVL and OVLVL registers are accessed as 32-bit registers with the eight MSBs padded with 0s.

Neutral Current Mismatch—ADE7868A and ADE7878A

Neutral current mismatch is available in the ADE7868A and ADE7878A only. In 3-phase systems, the neutral current is equal to the algebraic sum of the phase currents

$$I_N(t) = I_A(t) + I_B(t) + I_C(t) \tag{8}$$

A mismatch between these two quantities indicates that a tamper situation may have occurred in the system.

The ADE7868A/ADE7878A compute the sum of the phase currents by adding the content of the IAWV, IBWV, and ICWV registers and storing the result into the ISUM 28-bit signed register, as follows:

$$I_{SUM}(t) = I_A(t) + I_B(t) + I_C(t) \tag{9}$$

ISUM is computed every 125 μs (8 kHz frequency), the rate at which the current samples are available; Bit 17 (DREADY) in the STATUS0 register signals when the ISUM register can be read. For more information about the DREADY bit, see the Digital Signal Processor section.

To recover the I_{SUM}(t) value from the ISUM register, use the following expression:

$$I_{SUM}(t) = \frac{ISUM[27:0]}{ADC_{MAX}} \times I_{FS} \tag{10}$$

where:

ADC_{MAX} = 5,928,256, the ADC output when the input is at full scale.

I_{FS} is the full-scale ADC phase current.

Note that the ADE7868A/ADE7878A also compute the rms of I_{SUM} and store it in the NIRMS register when Bit 0 in the CONFIG_A register (INSEL) is set to 1 (see the Current RMS Calculation section for more information).

The ADE7868A/ADE7878A compute the difference between the absolute values of ISUM and the neutral current from the INWV register, taking the absolute value and comparing it against the ISUMLVL threshold.

If

$$\|ISUM| - |INWV|\| \leq ISUMLVL \tag{11}$$

it is assumed that the neutral current is equal to the sum of the phase currents, and the system functions correctly.

If

$$\|ISUM| - |INWV|\| > ISUMLVL \tag{12}$$

a tamper situation may have occurred, and Bit 20 (MISMTCH) in the STATUS1 register is set to 1.

An interrupt attached to the flag can be enabled by setting Bit 20 (MISMTCH) in the MASK1 register. When enabled, the IRQ1 pin is set to low when the Status Bit MISMTCH is set to 1. Writing to the STATUS1 register with Bit 20 (MISMTCH) set to 1 clears the status bit and returns the IRQ1 pin to high.

If $\|ISUM| - |INWV|\| \leq ISUMLVL$, the MISMTCH bit = 0.

If $\|ISUM| - |INWV|\| > ISUMLVL$, the MISMTCH bit = 1

ISUMLVL, the positive threshold used in Equation 11 and Equation 12, is a 24-bit signed register. Because it is used in a comparison with an absolute value, always set ISUMLVL to a positive number from 0x00000 to 0x7FFFFF. ISUMLVL uses the same scale as the outputs of the current ADC; therefore, writing 5,928,256 (0x5A7540) to the ISUMLVL register sets the mismatch detection level to full scale (see the Current Channel ADC section).

Writing 0x000000 (the default value) or a negative value to the ISUMLVL register signifies that the MISMTCH event is always triggered. To avoid continuously triggering MISMTCH events, write the appropriate value for the application to the ISUMLVL register after power-up or after a hardware or software reset.

The serial ports of the ADE7868A/ADE7878A work with 32-, 16-, or 8-bit words, whereas the DSP works with 28-bit words. The 28-bit signed ISUM register is transmitted as a 32-bit register with the four MSBs padded with 0s (see Figure 54).



Figure 54. ISUM[27:0] Register Transmitted as a 32-Bit Word

Like the xIGAIN registers shown in Figure 34, the ISUMLVL register is sign extended to 28 bits and padded with four 0s for transmission as a 32-bit register.

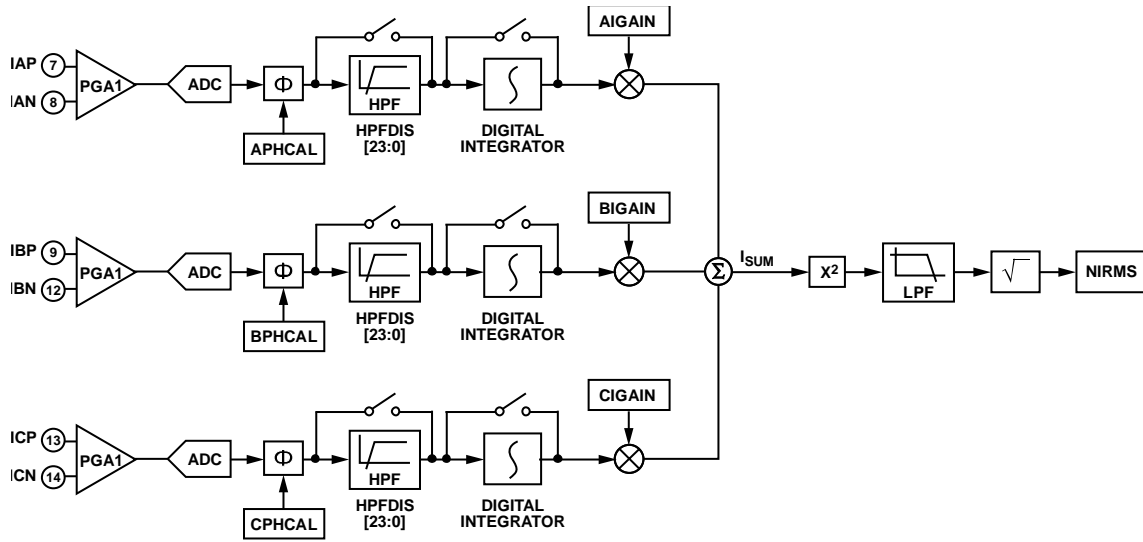

Figure 55. Sum of the Phase Currents Stored in the NIRMS Register

111386-151

PHASE COMPENSATION

As described in the Current Channel ADC and Voltage Channel ADC sections, the datapath for both current and voltages is the same. The phase error between current and voltage signals introduced by the ADE7854A/ADE7858A/ADE7868A/ADE7878A is negligible. However, the ADE7854A/ADE7858A/ADE7868A/ADE7878A must work with transducers that may have inherent phase errors. For example, a current transformer (CT) with a phase error of 0.1° to 3° is common. These phase errors can vary from device to device, and they must be corrected to perform accurate power calculations.

The errors associated with phase mismatch are particularly noticeable at low power factors. The phase calibration registers digitally calibrate these small phase errors. To compensate for the small phase errors, a small time delay or time advance is introduced into the signal processing chain of the device.

The phase calibration registers (APHCAL, BPHCAL, and CPHCAL) are 10-bit registers that can vary the time advance in the voltage channel signal path from -374.0 μs to +61.5 μs. Negative values written to the xPHCAL registers represent a time advance, whereas positive values represent a time delay. One LSB is equivalent to 0.976 μs of time delay or time advance (at a clock rate of 1.024 MHz). At a line frequency of 60 Hz, this gives a phase resolution of 0.0211° (360° × 60 Hz/1.024 MHz) at the fundamental. This corresponds to a total correction range of -8.079° to +1.329° at 60 Hz. At 50 Hz, the correction range is -6.732° to +1.107° and the resolution is 0.0176° (360° × 50 Hz/1.024 MHz).

Given a phase error of x degrees, measured using the phase voltage as the reference, the corresponding LSBs are computed by dividing x by the phase resolution (0.0211°/LSB for 60 Hz and 0.0176°/LSB for 50 Hz). Results between -383 and +63 are the only acceptable values; numbers outside this range are not accepted. When the current leads the voltage, the result is negative and the absolute value is written into the xPHCAL registers. When the current lags the voltage, the result is positive and 512 is added to the result before writing it into xPHCAL.

$$APHCAL, BPHCAL, \text{ or } CHPCAL = \tag{13}$$

$$\left\{ \begin{array}{l} \left\lfloor \frac{x}{PHASE_RESOLUTION} \right\rfloor, x \leq 0 \\ \left\lceil \frac{x}{PHASE_RESOLUTION} \right\rceil + 512, x > 0 \end{array} \right.$$

Figure 57 shows the use of phase compensation to remove an x = -1° phase lead in the IA current channel from the external current transducer (equivalent of 55.5 μs for 50 Hz systems). To cancel the lead (1°) in the current channel of Phase A, introduce a phase lead into the corresponding voltage channel. Using Equation 13, APHCAL is 57 LSBs, rounded up from 56.8. To achieve the phase lead, introduce a time delay of 55.73 μs into the Phase A current.

The serial ports of the device work with 32-, 16-, or 8-bit words, whereas the DSP works with 28-bit words. As shown in Figure 56, the 10-bit APHCAL, BPHCAL, and CPHCAL registers are accessed as 16-bit registers with the six MSBs padded with 0s.

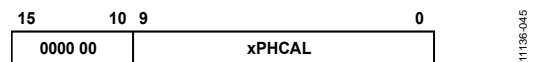

Figure 56. xPHCAL Registers Transmitted as 16-Bit Registers

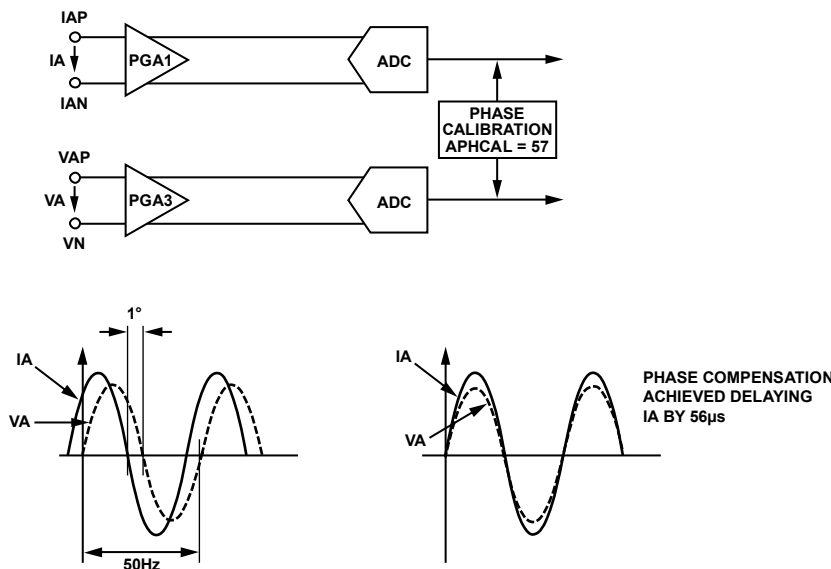

Figure 57. Phase Calibration on Voltage Channels

11136-046

REFERENCE CIRCUIT

The nominal reference voltage at the REF_{IN/OUT} pin is 1.2 V. This is the reference voltage for the ADCs in the ADE7854A/ADE7858A/ADE7868A/ADE7878A. Use a typical external reference voltage of 1.2 V to overdrive the REF_{IN/OUT} pin. The temperature coefficient of the internal voltage reference is calculated based on the endpoint method. To calculate the drift over temperature, the values of the voltage reference at endpoints (-40°C and +85°C) are measured and compared to the reference value at 25°C, which in turn provides the slope of the temperature coefficient curve. Figure 58 is a typical representation of the drift over temperature. It contains two curves: Curve X and Curve Y, which are typical representations of two possible curvatures that are observed over the entire specified temperature range.



Figure 58. Internal Voltage Reference Temperature Drift

Figure 58 shows that independent consideration of two regions is necessary for accurate analysis of the drift over temperature, as follows:

- Considering the region between Point A and Point B in Curve X, the reference value increases with an increase in temperature; thus, the curve has a positive slope from A to B. This results in a positive temperature coefficient in this region.
- Considering the region between Point B and Point C in Curve X, the slope of the curve is negative because the voltage reference decreases with an increase in temperature; thus, this region of the curve has a negative temperature coefficient.
- Based on similar logic, Curve Y has a negative temperature coefficient between Point A' and Point B and a positive temperature coefficient between Point B and Point C'.

The drift curve on any particular IC can be matched with either of these sample curves. The general relationship between the absolute value of the voltage reference at a particular endpoint temperature and the temperature coefficient for that region of the curve is explained by the following two equations:

$$V_{REF (-40^\circ\text{C})} = V_{REF (+25^\circ\text{C})} \times \left(1 + \frac{\alpha_c (-40^\circ\text{C} - 25^\circ\text{C})}{10^6} \right)$$

$$V_{REF (85^\circ\text{C})} = V_{REF (25^\circ\text{C})} \times \left(1 + \frac{\alpha_h (85^\circ\text{C} - 25^\circ\text{C})}{10^6} \right)$$

where α_c and α_h are cold and hot temperature coefficients, respectively, calculated by

$$\alpha_c = \frac{V_{REF (-40^\circ\text{C})} - V_{REF (+25^\circ\text{C})}}{(-40^\circ\text{C} - 25^\circ\text{C})} \times 10^6 \text{ ppm/}^\circ\text{C}$$

$$\alpha_h = \frac{V_{REF (85^\circ\text{C})} - V_{REF (25^\circ\text{C})}}{(85^\circ\text{C} - 25^\circ\text{C})} \times 10^6 \text{ ppm/}^\circ\text{C}$$

As the sign of cold and hot temperature coefficients can vary from one IC to another, the typical drift is specified for the whole range with a plus or minus sign (\pm). To find the typical, minimum, and maximum temperature coefficients, as listed in the Specifications section, data based on the endpoint method is collected on ICs spread across different lots. The minimum and maximum temperature coefficients denote that the drift of any particular IC is within those limits, over the specified temperature range, with reference to 25°C. See Figure 59 and Figure 60 for the device to device variation of the drift.



Figure 59. Histogram of the Reference Drift from -40°C to +25°C

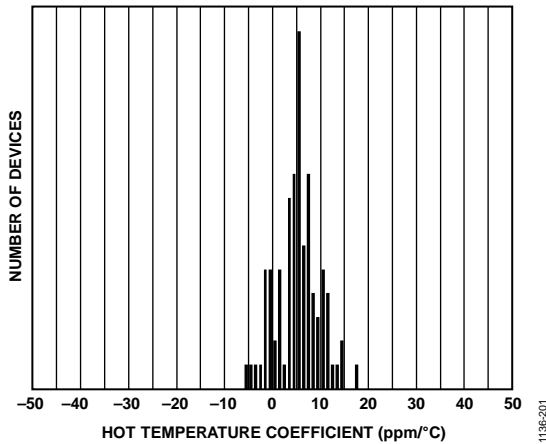

Figure 60. Histogram of the Reference Drift from 25°C to 85°C

Because the reference is used for all ADCs, any x% drift in the reference results in a 2x% deviation of the meter accuracy. The reference drift resulting from temperature changes is usually very small and, typically, much smaller than the drift of other components on a meter.

The [ADE7854A/ADE7858A/ADE7868A/ADE7878A](#) use the internal voltage reference when Bit 0 (EXTREFEN) in the CONFIG2 register is cleared to 0 (the default value); the external voltage reference is used when the bit is set to 1. Set the CONFIG2 register during the PSM0 mode; its value is maintained during the PSM1, PSM2, and PSM3 power modes.

DIGITAL SIGNAL PROCESSOR

The [ADE7854A/ADE7858A/ADE7868A/ADE7878A](#) contain a fixed function digital signal processor (DSP) that computes all power and rms values. It contains program memory ROM and data memory RAM.

The program used for the power and rms computations is stored in the program memory ROM, and the processor executes it every 8 kHz. The end of the computations is signaled by setting Bit 17 (DREADY) to 1 in the STATUS0 register. To enable an interrupt attached to this flag, set Bit 17 (DREADY) in the MASK0 register. When enabled, the IRQ0 pin is set low and the Status Bit DREADY is set to 1 at the end of the computations. Writing to the STATUS0 register with Bit 17 (DREADY) set to 1 clears the status bit and sets the $\overline{\text{IRQ0}}$ pin to high.

The registers used by the DSP are located in the data memory RAM, at addresses between 0x4380 and 0x43BE. The width of this memory is 28 bits. Within the DSP core, the DSP contains a two-stage pipeline. This means that when a single register must be initialized, two more writes are required to ensure that the value has been written into RAM. If two or more registers must be initialized, the last register must be written two more times to ensure that the value has been written into RAM.

As explained in the Power-Up Procedure section, at power-up or after a hardware or software reset, the DSP is in idle mode and executes no instruction. All the registers located in the data memory RAM are initialized at 0, their default values, and they

can be read/written without any restriction. The run register, used to start and stop the DSP, is cleared to 0x0000; write 0x0001 to the run register to start DSP code execution.

To protect the integrity of the data stored in the data memory RAM of the DSP (addresses between 0x4380 and 0x43BE), a write protection mechanism is available. By default, the protection is disabled, and registers placed between 0x4380 and 0x43BE can be written without restriction. When the protection is enabled, no writes to these registers are allowed. Registers can always be read without restriction, independent of the write protection state.

To enable the protection, write 0xAD to an internal 8-bit register located at Address 0xE7FE, followed by a write of 0x80 to an internal 8-bit register located at Address 0xE7E3.

Enable the write protection only after initializing the registers. If any data memory RAM-based register must be changed, disable the protection, change the value, and then reenables the protection. There is no need to stop the DSP to change these registers.

To disable the protection, write 0xAD to an internal 8-bit register located at Address 0xE7FE, followed by a write of 0x00 to an internal 8-bit register located at Address 0xE7E3.

Use the following procedure to initialize the [ADE7854A/ADE7858A/ADE7868A/ADE7878A](#) registers at power-up:

1. Initialize the AIGAIN, BIGAIN, CIGAIN, and NIGAIN registers.
2. Initialize all the other data memory RAM registers. Write the last register in the queue three times to ensure that its value was written into the RAM.
3. Initialize all of the other [ADE7854A](#), [ADE7858A](#), [ADE7868A](#), or [ADE7878A](#) registers with the exception of the CFMODE register.
4. Enable the write protection by writing 0xAD to an internal 8-bit register located at Address 0xE7FE, followed by a write of 0x80 to an internal 8-bit register located at Address 0xE7E3.
5. Read back all data memory RAM registers to ensure that they initialized with the desired values.
6. In the unlikely case that one or more registers did not initialized correctly, disable the protection by writing 0xAD to an internal 8-bit register located at Address 0xE7FE, followed by a write of 0x00 to an internal 8-bit register located at Address 0xE7E3.
 - a. Reinitialize the registers. Write the last register in the queue three times.
 - b. Enable the write protection by writing 0xAD to an internal 8-bit register located at Address 0xE7FE, followed by a write of 0x80 to an internal 8-bit register located at Address 0xE7E3.
7. Start the DSP by setting run = 1.
8. Read the energy registers (xWATTHR, xFWATTHR, xVARHR, xFVARHR, and xVAHR) to erase their content and start energy accumulation from a known state.
9. Clear Bit 9 (CF1DIS), Bit 10 (CF2DIS), and Bit 11 (CF3DIS) in the CFMODE register to enable pulses at

the CF1, CF2, and CF3/HSCLK pins. Do this initialization last, so that no spurious pulses are generated while the [ADE7854A/ADE7858A/ADE7868A/ADE7878A](#) are initialized.

There is no obvious reason to stop the DSP when maintaining the device in PSM0 normal mode. All [ADE7854A](#), [ADE7858A](#), [ADE7868A](#), and [ADE7878A](#) registers, including ones located in the data memory RAM, can be modified without stopping the DSP. However, to stop the DSP, write 0x0000 into the run register.

To restart the DSP, select one of the following procedures:

- If the [ADE7854A/ADE7858A/ADE7868A/ADE7878A](#) registers located in the data memory RAM have not been modified, write 0x0001 into the run register to start the DSP.
- If the [ADE7854A/ADE7858A/ADE7868A/ADE7878A](#) registers located in the data memory RAM must be modified, first execute a software or hardware reset, and then follow the recommended procedure to initialize the registers at power-up.

As mentioned in the Power Management section, when the [ADE7854A/ADE7858A/ADE7868A/ADE7878A](#) exit PSM0 power mode, it is recommended to stop the DSP by writing 0x0000 to the run register (see Table 11 and Table 12 for the recommended actions when changing power modes).

ROOT MEAN SQUARE MEASUREMENT

Root mean square (rms) is a measurement of the magnitude of an ac signal. Its definition can be both practical and mathematical. Defined practically, the rms value assigned to an ac signal is the amount of dc required to produce an equivalent amount of power in the load. is defined as

$$F_{rms} = \sqrt{\frac{1}{T} \int_0^T f^2(t) dt} \quad (14)$$

where F_{rms} is the mathematical rms value of a continuous signal $f(t)$.

For time sampling signals, rms calculation involves squaring the signal, taking the average, and obtaining the square root.

$$F_{rms} = \sqrt{\frac{1}{N} \sum_{N=1}^N f^2[n]} \quad (15)$$

Equation 15 implies that, for signals containing harmonics, the rms calculation contains the contribution of all harmonics, not only the fundamental. The device uses two different methods to calculate rms values. The first method is very accurate and is active only in PSM0 mode. The second method is less accurate and uses the estimation of the mean absolute value (MAV) measurement; this method is active in PSM0 and PSM1 modes and is available for the [ADE7868A](#) and [ADE7878A](#) only.

The first method is to filter the square of the input signal using a low-pass filter (LPF) and take the square root of the result (see Figure 61).

$$f(t) = \sum_{k=1}^{\infty} F_k \sqrt{2} \sin(k\omega t + \gamma_k) \quad (16)$$

The square of $f(t)$ is

$$f^2(t) = \sum_{k=1}^{\infty} F_k^2 - \sum_{k=1}^{\infty} F_k^2 \cos(2k\omega t + 2\gamma_k) + 2 \sum_{\substack{k,m=1 \\ k \neq m}}^{\infty} 2 \times F_k \times F_m \sin(k\omega t + \gamma_k) \times \sin(m\omega t + \gamma_m) \quad (17)$$

After the LPF and the execution of the square root, the rms value of $f(t)$ is obtained by

$$F = \sqrt{\sum_{k=1}^{\infty} F_k^2} \quad (18)$$

All seven analog input channels simultaneously process the rms calculation based on this method. Each result is available in the following 24-bit registers: AIRMS, BIRMS, CIRMS, AVRMS, BVRMS, CVRMS, and NIRMS (NIRMS is available on the [ADE7868A](#) and [ADE7878A](#) only). An average of 1.024 sec of these readings is also available (see the Low Ripple Current RMS and Low Ripple Voltage sections for more information).

The second method computes the absolute value of the input signal and then filters it to extract its dc component. This method computes the absolute mean value of the input. When the input signal in Equation 17 has a fundamental component only, its average value is

$$F_{dc} = \frac{1}{T} \left[\int_0^{\frac{T}{2}} \sqrt{2} \times F_1 \times \sin(\omega t) dt - \int_{\frac{T}{2}}^T \sqrt{2} \times F_1 \times \sin(\omega t) dt \right]$$

$$F_{dc} = \frac{2}{\pi} \times \sqrt{2} \times F_1 \quad (19)$$

The calculation based on this method is simultaneously processed on the three phase currents only. Each result is available in the following 20-bit registers: AIMAV, BIMAV, and CIMAV (available on the [ADE7868A](#) and [ADE7878A](#) only). Note that the proportionality between the MAV and rms values is maintained for the fundamental components only. If harmonics are present in the current channel, the mean absolute value is no longer proportional to rms.

Current RMS Calculation

This section presents the first approach to compute the rms values of all phase and neutral currents. The [ADE7868A](#) and [ADE7878A](#) also compute the rms of the sum of the instantaneous values of the phase currents when Bit 0 (INSEL) in the CONFIG_A register is set to 1. The result is stored in the NIRMS register. Note that the instantaneous value of the sum is stored into the ISUM register (see the Neutral Current Mismatch—[ADE7868A](#) and [ADE7878A](#) section). In 3-phase, 4-wire systems that require sensing the phase currents only, these values provide a measure of the neutral current.

Figure 61 shows the signal processing chain for the rms calculation on one of the phases of the current channel. The current channel rms value is processed from the samples used in the current channel. The current rms values are signed 24-bit values and they are stored in the AIRMS, BIRMS, CIRMS, and NIRMS (ADE7868A/ADE7878A only) registers. The update rate of the current rms measurement is 8 kHz.

With the specified full-scale analog input signal of 0.5 V, the ADC produces an output code that is approximately $\pm 5,928,256$. The equivalent rms value of a full-scale sinusoidal signal is 4,191,910 (0x3FF6A6), independent of the line frequency. Enabling the integrator by setting Bit 0 (INTEN) in the CONFIG register to 1 produces an equivalent rms value of a full-scale sinusoidal signal of 4,191,910 (0x3FF6A6) at 50 Hz and 3,493,258 (0x354D8A) at 60 Hz.

The accuracy of the current rms is typically 0.1% error from the full-scale input down to 1/1000 of the full-scale input when PGA = 1. Additionally, this measurement has a bandwidth of 2 kHz. To ensure stability, read the rms registers synchronous to the voltage zero crossings. Use the IRQ1 interrupt to indicate when a zero crossing has occurred (see the Interrupts section).

Table 13 shows the settling time for the I rms measurement, which is the time it takes for the rms register to reflect the value at the input to the current channel when starting from 0 to full scale. However, during the chip power-up and DSP reset cases,

it typically takes about 1.2 seconds for an FS/1000 signal to be settled.

Table 13. Settling Time for I RMS Measurement

Integrator Status	50 Hz Input Signals	60 Hz Input Signals
Integrator Off	440 ms	440 ms
Integrator On	550 ms	500 ms

As stated in the Current Waveform Gain Registers section, the serial ports of the ADE7854A, ADE7858A, ADE7868A, and ADE7878A work on 32-, 16-, or 8-bit words. Similar to the register shown in Figure 37, the AIRMS, BIRMS, CIRMS, and NIRMS (ADE7868A/ADE7878A only) 24-bit signed registers are accessed as 32-bit registers with the eight MSBs padded with 0s.

Low Ripple Current RMS

The ADE7854A, ADE7858A, ADE7868A, and ADE7878A provide an average of 1.024 sec of current rms data. The averaged current rms values are signed 24-bit values that are stored in the IARMS_LRIP, IBRMS_LRIP, ICRMS_LRIP, and INRMS_LRIP registers (ADE7868A and ADE7878A only). The low ripple registers remove the need for external averaging and provide a stable reading. These average rms registers are updated every 1.024 sec and contain an average of the previous 8192 rms samples. The IxRMS_LRIP register readings settle to within 99% after 2.048 sec.

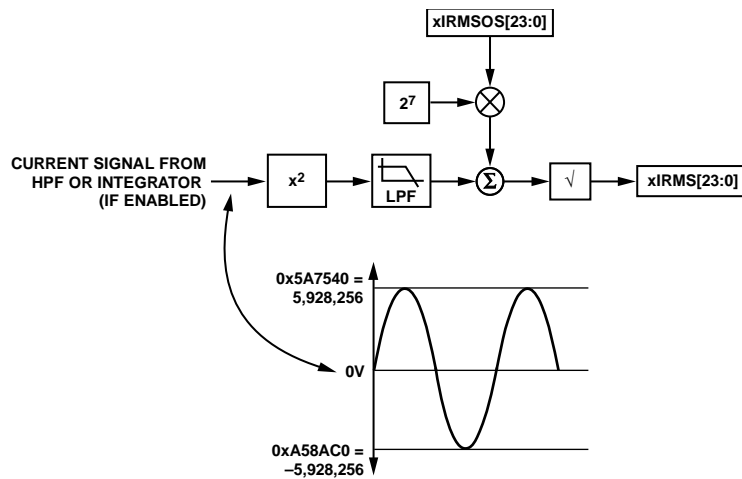

Figure 61. Current RMS Signal Processing

11136-047

Current RMS Offset Compensation

The ADE7854A/ADE7858A/ADE7868A/ADE7878A incorporate a current rms offset compensation register for each phase: AIRMSOS, BIRMSOS, CIRMSOS; the NIRMSOS register is provided in the ADE7878A and ADE7868A only. These 24-bit signed registers remove offsets in the current rms calculations. An offset can exist in the rms calculation caused by input noises that are integrated in the dc component of $i^2(t)$. The current rms offset register is multiplied by 128 and added to the squared current rms before the square root is executed. Assuming that the maximum value from the current rms calculation is 4,191,910 with full-scale ac inputs (50 Hz), one LSB of the current rms offset represents the following value of the rms measurement at 60 dB down from full scale:

$$0.00037\% = \left(\frac{\sqrt{4191^2 + 128}}{4191} - 1 \right) \times 100$$

Conduct offset calibration at low current; avoid using currents equal to zero for calibration purposes.

$$I_{rms} = \sqrt{I_{rms_0}^2 + 128 \times IRMSOS} \tag{20}$$

where I_{rms_0} is the rms measurement without offset correction.

The serial ports of the ADE7854A, ADE7858A, ADE7868A, and ADE7878A work with 32-, 16-, or 8-bit words, whereas the DSP works with 28-bit words. Like the xIGAIN registers shown in Figure 34, the 24-bit AIRMSOS, BIRMSOS, CIRMSOS, and NIRMSOS (ADE7868A/ADE7878A only) registers are sign extended to 28 bits and padded with four 0s for transmission as 32-bit registers.

Current Mean Absolute Value Calculation—ADE7868A and ADE7878A Only

This section describes the second approach to estimate the rms values of all phase currents using the mean absolute value (MAV) method. This approach is used in PSM1 mode, which is available to the ADE7868A and ADE7878A only, to allow energy accumulation based on current rms values when the missing neutral case is identified as a tamper attack. This datapath is also active in PSM0 mode to allow for its gain calibration. The external microprocessor uses the gain during PSM1 mode. The MAV value of the neutral current is not computed using this method. Figure 62 shows the signal processing chain for the MAV calculation on one phase of the current channel.

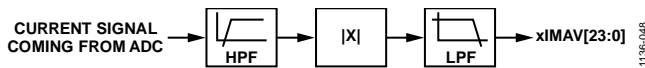

Figure 62. Current MAV Signal Processing for PSM1 Mode

The current channel MAV value is processed from the samples used in the current channel waveform sampling mode. The samples pass through a high-pass filter to eliminate the eventual dc offsets introduced by the ADCs and the absolute values are computed.

Next, to obtain the average, outputs of this block are filtered. The current MAV values are unsigned 20-bit values and are stored in the AIMAV, BIMAV, and CIMAV registers. The update rate of this MAV measurement is 8 kHz.

The MAV values of full-scale sinusoidal signals of 50 Hz and 60 Hz are 209,686 and 210,921, respectively. There is a 1.25% variation between the MAV estimate at 45 Hz and the one at 65 Hz for full-scale sinusoidal inputs (see Figure 63).



Figure 63. xIMAV Register Values at Full Scale, 45 Hz to 65 Hz Line Frequencies

The accuracy of the current MAV is typically 0.5% error from the full-scale input down to 1/100 of the full-scale input. Additionally, this measurement has a bandwidth of 2 kHz. The settling time for the current MAV measurement, that is, the time it takes for the MAV register to reflect the value at the input to the current channel within 0.5% error, is 500 ms.

As stated in the Current Waveform Gain Registers section, the serial ports of the ADE7868A/ADE7878A work on 32-, 16-, or 8-bit words. As shown in Figure 64, the AIMAV, BIMAV, and CIMAV 20-bit unsigned registers are accessed as 32-bit registers with the 12 MSBs padded with 0s.



Figure 64. xIMAV Registers Transmitted as 32-Bit Registers

Current MAV Gain and Offset Compensation

The current rms values stored in the AIMAV, BIMAV, and CIMAV registers can be calibrated using gain and offset coefficients corresponding to each phase. Calculate the gains in PSM0 mode by supplying the ADE7868A/ADE7878A with nominal currents. Estimate the offsets by supplying the ADE7868A/ADE7878A with low currents, usually equal to the minimum value at which the accuracy is required. Every time the external microcontroller reads the AIMAV, BIMAV, and CIMAV registers, it uses these coefficients, stored in its memory, to correct them.

Voltage RMS Calculation

Figure 65 shows the detail of the signal processing chain for the rms calculation on one phase of the voltage channel. The voltage channel rms value is processed from the samples used in the voltage channel. The voltage rms values are signed 24-bit values, and they are stored into the AVRMS, BVRMS, and CVRMS registers. The update rate of the current rms measurement is 8 kHz.

With the specified full-scale analog input signal of 0.5 V, the ADC produces an output code that is approximately $\pm 5,928,256$. The equivalent rms value of a full-scale sinusoidal signal is 4,191,910 (0x3FF6A6), independent of the line frequency.

The accuracy of the voltage rms is typically 0.1% error from the full-scale input down to 1/1000 of the full-scale input. Additionally, this measurement has a bandwidth of 2 kHz. Read the rms registers synchronous to the voltage zero crossings to ensure stability. Use the IRQ1 interrupt to indicate when a zero crossing has occurred (see the Interrupts section).

The settling time for the voltage rms measurement is 440 ms for both 50 Hz and 60 Hz input signals. The V rms measurement settling time is the time it takes for the rms register to reflect the value at the input to the voltage channel when starting from 0.

As stated in the Current Waveform Gain Registers section, the serial ports of the ADE7854A, ADE7858A, ADE7868A, and ADE7878A work on 32-, 16-, or 8-bit words. Similar to the register in Figure 37, the AVRMS, BVRMS, and CVRMS 24-bit signed registers are accessed as 32-bit registers with the eight MSBs padded with 0s.

Low Ripple Voltage RMS

The ADE7854A, ADE7858A, ADE7868A, and ADE7878A also provide the average of 1.024 sec of voltage rms data. The averaged voltage rms values are signed 24-bit values that are stored into the VARMS_LRIP, VBRMS_LRIP, and VCRMS_LRIP registers. The low ripple registers remove the need for external averaging and provide a stable reading. These average rms registers are updated every 1.024 sec and contain an average of the previous 8192 rms samples. The VxRMS_LRIP register readings settle to within 99% after 2.048 sec.

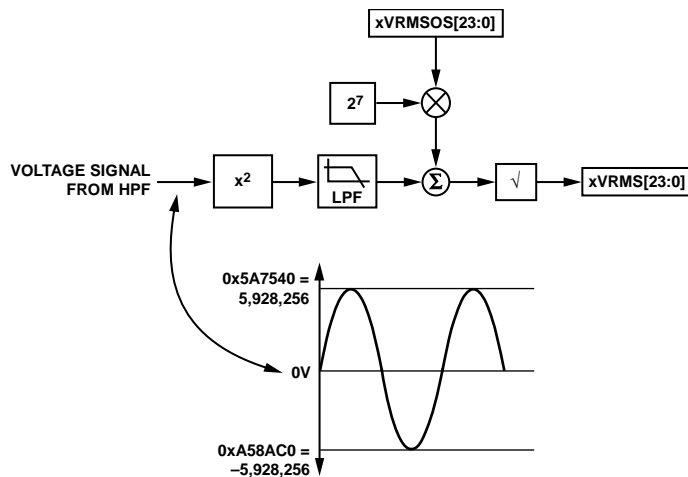

Figure 65. Voltage RMS Signal Processing

11136-051

Voltage RMS Offset Compensation

The ADE7854A, ADE7858A, ADE7868A, and ADE7878A incorporate voltage rms offset compensation registers for each phase: AVRMSOS, BVRMSOS, and CVRMSOS. These 24-bit signed registers remove offsets in the voltage rms calculations. An offset can exist in the rms calculation due to input noises that are integrated in the dc component of $V^2(t)$. The voltage rms offset register is multiplied by 128 and added to the squared voltage rms before the square root is executed. Assuming that the maximum value from the voltage rms calculation is 4,191,910 with full-scale ac inputs (50 Hz), one LSB of the voltage rms offset represents the following value of the rms measurement at 60 dB down from full scale:

$$0.00037\% = \left(\frac{\sqrt{4191^2 + 128}}{4191} - 1 \right) \times 100$$

Conduct offset calibration at low voltage; avoid using voltages equal to zero for calibration purposes.

$$V_{rms} = \sqrt{V_{rms_0}^2 + 128 \times VRMSOS} \quad (21)$$

where V_{rms_0} is the rms measurement without offset correction.

The serial ports of the ADE7854A, ADE7858A, ADE7868A, and ADE7878A work with 32-, 16-, or 8-bit words, whereas the DSP works with 28-bit words. Like the xIGAIN registers shown in Figure 34, the 24-bit AVRMSOS, BVRMSOS, and CVRMSOS registers are sign extended to 28 bits and padded with four 0s for transmission as 32-bit registers.

Voltage RMS in 3-Phase, 3-Wire Delta Configurations

In 3-phase, 3-wire delta configurations, Phase B is considered the ground of the system, and Phase A and Phase C voltages are measured relative to it. Select this configuration using the CONSEL bits equal to 01 in the ACCMODE register (see Table 16 for all configurations where the ADE7854A, ADE7858A, ADE7868A, and ADE7878A can be used). In this situation, all Phase B active, reactive, and apparent powers are 0.

In this configuration, the ADE7854A, ADE7858A, ADE7868A, and ADE7878A compute the rms value of the line voltage between Phase A and Phase C and store the result in the BVRMS register. BVGAIN and BVRMSOS registers can be used to calibrate the BVRMS register computed in this configuration.

ACTIVE POWER CALCULATION

The ADE7854A/ADE7858A/ADE7868A/ADE7878A compute the total active power on every phase. Total active power considers in its calculation all fundamental and harmonic components of the voltages and currents. In addition, the ADE7878A computes the fundamental active power, the power determined only by the fundamental components of the voltages and currents.

Total Active Power Calculation

Electrical power is defined as the rate of energy flow from source to load, and it is given by the product of the voltage and current waveforms. The resulting waveform is the instantaneous power signal, and it is equal to the rate of energy flow at every instant of time. The unit of power is the watt or joules/sec. If an ac system is supplied by a voltage, $v(t)$, and consumes the current, $i(t)$, and each of them contains harmonics, then

$$v(t) = \sum_{k=1}^{\infty} V_k \sqrt{2} \sin(k\omega t + \varphi_k) \quad (22)$$

$$i(t) = \sum_{k=1}^{\infty} I_k \sqrt{2} \sin(k\omega t + \gamma_k)$$

where:

V_k , I_k are the rms voltage and current, respectively, of each harmonic.

φ_k , γ_k are the phase delays of each harmonic.

The instantaneous power in an ac system is

$$p(t) = v(t) \times i(t) = \sum_{k=1}^{\infty} V_k I_k \cos(\varphi_k - \gamma_k) - \sum_{k=1}^{\infty} V_k I_k \cos(2k\omega t + \varphi_k + \gamma_k) + \sum_{\substack{k, m=1 \\ k \neq m}}^{\infty} V_k I_m \{ \cos[(k-m)\omega t + \varphi_k - \gamma_m] - \cos[(k+m)\omega t + \varphi_k + \gamma_m] \} \quad (23)$$

The average power over an integral number of line cycles (n) is given by the expression in Equation 24.

$$P = \frac{1}{nT} \int_0^{nT} p(t) dt = \sum_{k=1}^{\infty} V_k I_k \cos(\varphi_k - \gamma_k) \quad (24)$$

where:

T is the line cycle period.

P is the total active or total real power.

Note that the total active power is equal to the dc component of the instantaneous power signal $p(t)$ in Equation 23, that is,

$$\sum_{k=1}^{\infty} V_k I_k \cos(\varphi_k - \gamma_k)$$

Use this expression to calculate the total active power in the device for each phase. The expression of fundamental active power is obtained from Equation 24 with $k = 1$, as follows:

$$FP = V_1 I_1 \cos(\varphi_1 - \gamma_1) \quad (25)$$

Figure 66 shows how the device computes the total active power on each phase. First, it multiplies the current and voltage signals in each phase. Next, it extracts the dc component of the instantaneous power signal in each phase (A, B, and C) using LPF2, the low-pass filter.

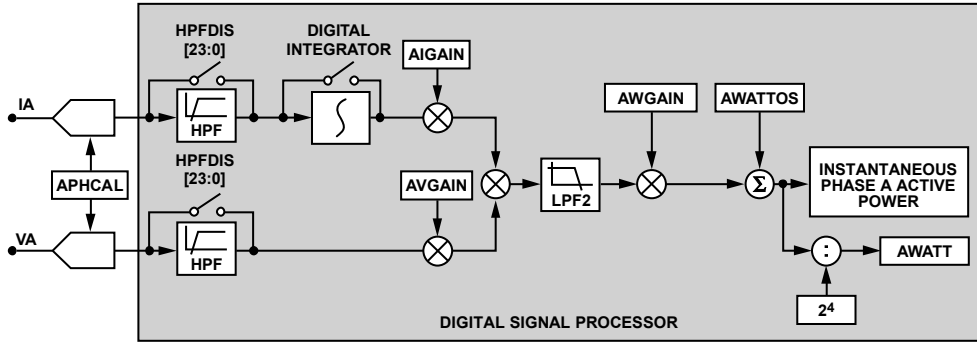

Figure 66. Total Active Power Datapath

If the phase currents and voltages contain only the fundamental component, are in phase (that is, $\phi_1 = \gamma_1 = 0$), and they correspond to full-scale ADC inputs, multiplying them results in an instantaneous power signal that has a dc component, $V_1 \times I_1$, and a sinusoidal component, $V_1 \times I_1 \cos(2\omega t)$; Figure 67 shows the corresponding waveforms.

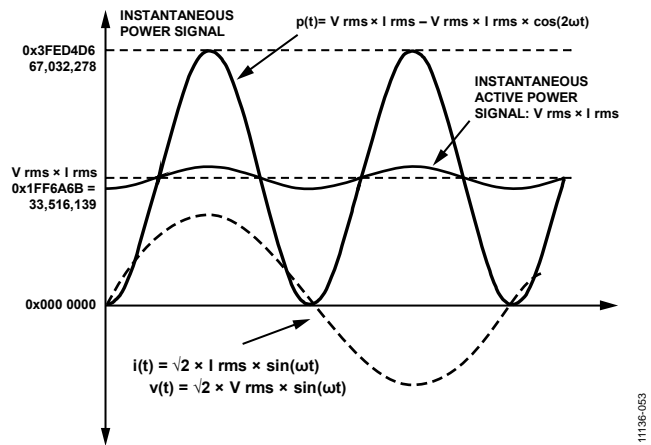

Figure 67. Active Power Calculation

Because LPF2 does not have an ideal brick wall frequency response (see Figure 68), the active power signal has some ripple caused by the instantaneous power signal. This ripple is sinusoidal and has a frequency equal to twice the line frequency. Because the ripple is sinusoidal in nature, it is removed when the active power signal is integrated over time to calculate the energy.

Bit 1 (LPFSEL) of the CONFIG_A register selects LPF2 strength. Setting LPFSEL to 0 (default), the settling time is 650 ms and the ripple attenuation is 65 dB. Setting LPFSEL to 1, the settling time is 1300 ms and the ripple attenuation is 128 dB. Figure 68 shows the frequency response of the LPF2 when the LPFSEL bit is set to 0, and Figure 69 shows the frequency response on the LPF2 when the LPFSEL bit is set to 1.

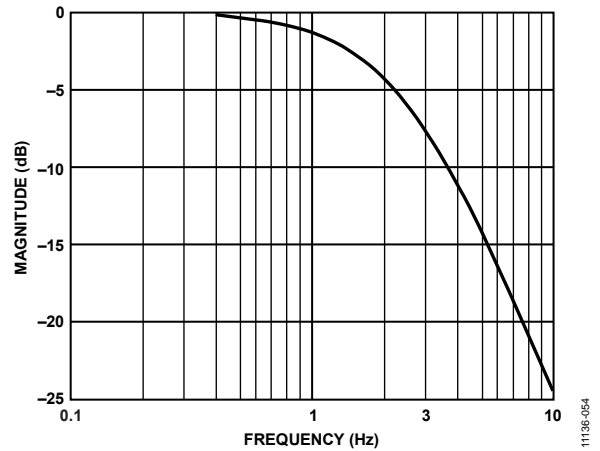

Figure 68. Frequency Response of the LPF2 Used to Filter Instantaneous Power in Each Phase: LPFSEL Bit of CONFIG_A Register Set to 0

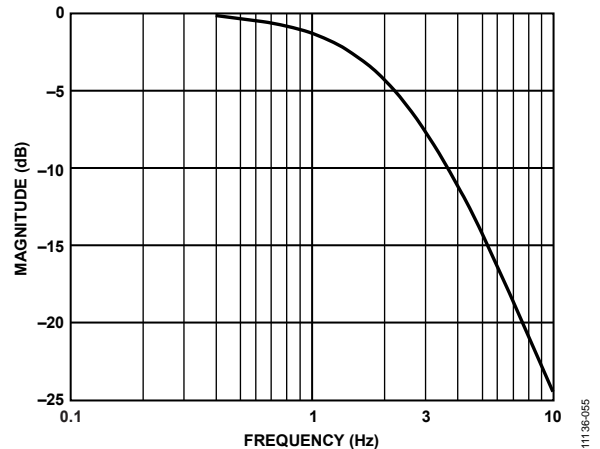

Figure 69. Frequency Response of the LPF2 Used to Filter Instantaneous Power in Each Phase: LPFSEL Bit of CONFIG_A Register Set to 1

The ADE7854A/ADE7858A/ADE7868A/ADE7878A store the instantaneous total phase active powers in the AWATT, BWATT, and CWATT registers. The expression for the registers is

$$xWATT = \sum_{k=1}^{\infty} \frac{V_k}{V_{FS}} \times \frac{I_k}{I_{FS}} \times \cos(\phi_k - \gamma_k) \times P_{MAX} \times \frac{1}{2^4} \quad (26)$$

where:

V_{FS} , I_{FS} are the rms values of the phase voltage and current when the ADC inputs are at full scale.

$P_{MAX} = 33,516,139$, which is the instantaneous power computed when the ADC inputs are at full scale and in phase.

Access the xWATT[23:0] waveform registers using various serial ports (see the Waveform Sampling Mode section).

Fundamental Active Power Calculation—ADE7878A Only

The ADE7878A computes the fundamental active power using a proprietary algorithm that requires some initialization function of the frequency of the network and its nominal voltage measured in the voltage channel. Bit 14 (SELFREQ) in the COMPMODE register must be set according to the frequency of the network to which ADE7878A is connected. Clear Bit 14 (SELFREQ) to 0 (the default value) when the network frequency is 50 Hz. Set SELFREQ to 1 when the network frequency is 60 Hz. In addition, initialize the VLEVEL 24-bit signed register with a positive value based on the following expression:

$$VLEVEL = \frac{V_{FS}}{V_n} \times 491,520 \quad (27)$$

where:

V_{FS} is the rms value of the phase voltages when the ADC inputs are at full scale.

V_n is the rms nominal value of the phase voltage.

As stated in the Current Waveform Gain Registers section, the serial ports of the ADE7878A work on 32-, 16-, or 8-bit words and the DSP works on 28 bits. Similar to the registers in Figure 34, the VLEVEL 24-bit signed register is accessed as a 32-bit register with the four MSBs padded with 0s and sign extended to 28 bits.

Table 14 lists the settling time for the fundamental active power measurement.

Table 14. Settling Times for Fundamental Active Power

63% Full-Scale Input Signals	100% Full-Scale Input Signals
375 ms	875 ms

Active Power Gain Calibration

Note that the average active power result from the LPF2 output in each phase can be scaled by $\pm 100\%$ by writing to the 24-bit phase watt gain register (AWGAIN, BWGAIN, CWGAIN, AFWGAIN, BFWGAIN, or CFWGAIN).

By writing to the phase watt gain 24-bit register (AWGAIN, BWGAIN, CWGAIN, AFWGAIN, BFWGAIN, or CFWGAIN), the average active power result from the PDF2 output in each phase is scaled by $\pm 100\%$.

The xWGAIN registers are placed in each phase of the total active power datapath, and the xFWGAIN (available for the ADE7878A only) registers are placed in each phase of the fundamental active power datapath. The watt gain registers are two's complement, signed registers and have a resolution of $2^{-23}/\text{LSB}$. Equation 28 describes mathematically the function of the watt gain registers.

Average Power Data =

$$LPF2 \text{ Output} \times \left(1 + \frac{\text{Watt Gain Register}}{2^{23}} \right) \quad (28)$$

The output is scaled by -50% by writing 0xC00000 to the watt gain registers, and it increases by $+50\%$ by writing 0x400000 to them. These registers calibrate the active power (or energy) calculation in the ADE7854A/ADE7858A/ADE7868A/ADE7878A for each phase.

As stated in the Current Waveform Gain Registers section, the serial ports of the ADE7854A/ADE7858A/ADE7868A/ADE7878A work on 32-, 16-, or 8-bit words, and the DSP works on 28 bits. Similar to registers presented in Figure 34, the AWGAIN, BWGAIN, CWGAIN, AFWGAIN, BFWGAIN, and CFWGAIN 24-bit signed registers are accessed as 32-bit registers with the four MSBs padded with 0s and sign extended to 28 bits.

Active Power Offset Calibration

The ADE7854A/ADE7858A/ADE7868A/ADE7878A incorporate a watt offset, 24-bit register on each phase and on each active power. The AWATTOS, BWATTOS, and CWATTOS registers compensate the offsets in the total active power calculations, and the AFWATTOS, BFWATTOS, and CFWATTOS registers compensate offsets in the fundamental active power calculations. These are signed two's complement, 24-bit registers that remove offsets in the active power calculations.

An offset can exist in the power calculation caused by crosstalk between channels on the PCB or in the chip itself. One LSB in the active power offset register is equivalent to 1 LSB in the active power multiplier output. At full-scale current and voltage inputs, the LPF2 output is $P_{MAX} = 33,516,139$. At -80 dB down from the full scale (active power scaled down 10^4 times), one LSB of the active power offset register represents 0.0298% of P_{MAX} .

As stated in the Current Waveform Gain Registers section, the serial ports of the ADE7854A/ADE7858A/ADE7868A/ADE7878A work on 32-, 16-, or 8-bit words and the DSP works on 28 bits. Similar to the registers shown in Figure 34, the AWATTOS, BWATTOS, CWATTOS, AFWATTOS, BFWATTOS, and CFWATTOS 24-bit signed registers are accessed as 32-bit registers with the four MSBs padded with 0s and sign extended to 28 bits.

Sign of Active Power Calculation

The average active power is a signed calculation. When the phase difference between the current and voltage waveform is more than 90° , the average power becomes negative. Negative power indicates that energy is being injected back on the grid. The ADE7854A/ADE7858A/ADE7868A/ADE7878A have sign detection circuitry for active power calculations and can monitor the total active powers or the fundamental active powers. As described in the Active Energy Calculation section, the active energy accumulation occurs in two stages. Every time a sign change is detected in the energy accumulation at the end of the

first stage, that is, after the energy accumulated into the internal accumulator reaches the WTHR register threshold, it triggers a dedicated interrupt. Read the sign of each phase active power using the PHSIGN register.

Bit 6 (REVAPSEL) in the ACCMODE register sets the type of active power being monitored. Setting REVAPSEL to 0, the default value, monitors the total active power. Setting REVAPSEL to 1 monitors the fundamental active power.

Bits[8:6] (REVAPC, REVAPB, and REVAPA, respectively) in the STATUS0 register are set when a sign change occurs in the power selected by Bit 6 (REVAPSEL) in the ACCMODE register.

Bits[2:0] (CWSIGN, BWSIGN, and AWSIGN, respectively) in the PHSIGN register are set simultaneously with the REVAPC, REVAPB, and REVAPA bits; these bits indicate the sign of the power. When these bits are set to 0, the corresponding power is positive; when they are set to 1, the corresponding power is negative.

Bit REVAPx in the STATUS0 register and Bit xWSIGN in the PHSIGN register refer to the total active power of Phase x, the power type that is selected by Bit 6 (REVAPSEL) in the ACCMODE register.

Interrupts attached to Bits[8:6] (REVAPC, REVAPB, and REVAPA, respectively) in the STATUS0 register are enabled by setting Bits[8:6] in the MASK0 register. When enabled, the IRQ0 pin is set low, and the status bit is set to 1 when a change of sign occurs. To find the phase that triggered the interrupt, after reading the STATUS0 register, immediately read the PHSIGN register. Next, writing to the STATUS0 register with the corresponding bit set to 1 clears the status bit and returns the IRQ0 pin to high.

Active Energy Calculation

As previously stated, power is defined as the rate of energy flow. This relationship is expressed mathematically as

$$Power = \frac{dEnergy}{dt} \tag{29}$$

Conversely, energy is the integral of power, expressed as follows:

$$Energy = \int p(t) dt \tag{30}$$

Total and fundamental active energy accumulations are always signed operations. Negative energy is subtracted from the active energy contents. The ADE7854A/ADE7858A/ADE7868A/ADE7878A achieve the integration of the active power signal in two stages (see Figure 71). The process is identical for both total and fundamental active powers. The first stage is accomplished inside the DSP: every 125 μs (8 kHz frequency) the instantaneous phase total or fundamental active power accumulates into an internal register. Upon reaching a threshold, a pulse is generated at the processor port, and the threshold is subtracted from the internal register. The sign of the energy in this moment is considered the sign of the active power (see the Sign of Active Power Calculation section). The second stage occurs outside the DSP and consists of accumulating the pulses generated by the processor into internal 32-bit accumulation registers. When these registers are accessed, the content of these registers transfers to the watt-hour registers, xWATTHR and xFWATTHR (see Figure 70).

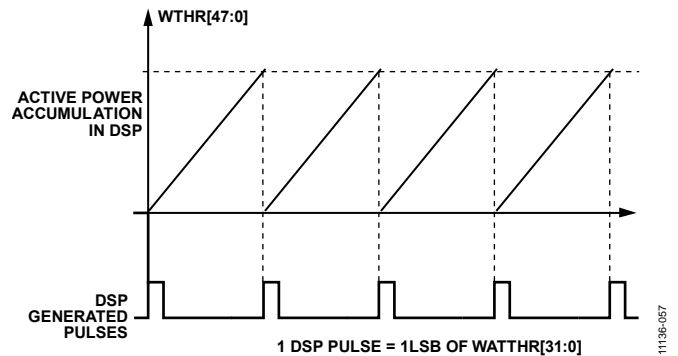

Figure 70. Active Power Accumulation Inside the DSP



Figure 71. Total Active Energy Accumulation

The WTHR 48-bit signed register contains the threshold, introduced by the user, and it is common for all phase total and fundamental active powers. Its value depends on the amount of energy assigned to 1 LSB of watt-hour registers.

When a derivative of active energy (wh) of $[10^n \text{ wh}]$, where n is an integer, is desired as 1 LSB of the xWATTHR register, the xWATTHR register can be computed using the following equation:

$$xWTHR = \frac{P_{MAX} \times f_s \times 3600 \times 10^n}{V_{FS} \times I_{FS}} \quad (31)$$

where:

$P_{MAX} = 33,516,139 = 0x1FF6A6B$, the instantaneous power computed when the ADC inputs are at full scale.

$f_s = 8 \text{ kHz}$, the frequency with which the DSP computes the instantaneous power.

V_{FS}, I_{FS} are the rms values of phase voltages and currents when the ADC inputs are at full scale.

The maximum value that can be written to WTHR is $2^{47} - 1$. The minimum value is $0x0$, but it is recommended to write a number equal to or greater than P_{MAX} . Never use negative numbers.

WTHR is a 48-bit register. As stated in the Current Waveform Gain Registers section, the serial ports of the ADE7854A/ADE7858A/ADE7868A/ADE7878A work on 32-, 16-, or 8-bit words. As shown in Figure 72, the WTHR register is accessed as two 32-bit registers (WTHR1 and WTHR0), each having eight MSBs padded with 0s.



Figure 72. WTHR[47:0] Transmitted as Two 32-Bit Registers

This discrete time accumulation or summation is equivalent to integration in continuous time per Equation 32.

$$Energy = \int p(t)dt = \lim_{T \rightarrow 0} \left\{ \sum_{n=0}^{\infty} p(nT) \times T \right\} \quad (32)$$

where:

n is the discrete time sample number.

T is the sample period.

In the ADE7854A/ADE7858A/ADE7868A/ADE7878A, the total phase active powers accumulate in the AWATTHR, BWATTHR, and CWATTHR 32-bit signed registers, and the fundamental phase active powers accumulate in the AFWATTHR, BFWATTHR, and CFWATTHR 32-bit signed registers. When the active power is positive, the active energy register content rolls over to full-scale negative ($0x80000000$) and continues to increase in value. Conversely, when the active power is negative, the energy register underflows to full-scale positive ($0x7FFFFFFF$) and continues to decrease in value.

Bit 0 (AEHF) in the STATUS0 register is set when Bit 30 of one of the xWATTHR registers changes, signifying that one of these registers is half full. If the active power is positive, the watt-hour register becomes half full when it increments from $0x3FFFFFFF$ to $0x40000000$. If the active power is negative, the watt-hour register becomes half full when it decrements from $0xC0000000$ to $0xBFFFFFFF$. Similarly, Bit 1 (FAEHF) in the STATUS0 register is set when Bit 30 of one of the xFWATTHR registers changes, signifying that one of these registers is half full.

Setting Bits[1:0] in the MASK0 register enable the FAEHF and AEHF interrupts, respectively. If enabled, the $\overline{IRQ0}$ pin is set low and the status bit is set to 1 whenever one of the energy registers, xWATTHR (for the AEHF interrupt) or xFWATTHR (for the FAEHF interrupt), become half full. Writing to the STATUS0 register with the corresponding bit set to 1 clears the status bit and sets the $\overline{IRQ0}$ pin to logic high.

Setting Bit 6 (RSTREAD) of the LCYCMODE register enables a read-with-reset for all watt-hour accumulation registers; that is, the registers are reset to 0 after a read operation.

Integration Time Under Steady Load

The discrete time sample period (t) for the accumulation register is $125 \mu\text{s}$ (8 kHz frequency). With full-scale sinusoidal signals on the analog inputs and the watt gain registers set to $0x00000$, the average word value from each LPF2 is $P_{MAX} = 33,516,139 = 0x1FF6A6B$. Setting the WTHR register threshold at the P_{MAX} level generates a DSP pulse added every $125 \mu\text{s}$ to the watt-hour registers.

The maximum value that can be stored in the watt-hour accumulation register before it overflows is $2^{31} - 1$ or $0x7FFFFFFF$.

Calculate the integration time as

$$Time = 0x7FFFFFFF \times 125 \mu\text{s} = 74 \text{ hr}, 33 \text{ min}, 55 \text{ sec} \quad (33)$$

Energy Accumulation Modes

The active power accumulated in each 32-bit watt-hour accumulation register (AWATTHR, BWATTHR, CWATTHR, AFWATTHR, BFWATTHR, and CFWATTHR) depends on the configuration of Bit 5 and Bit 4 (CONSEL bits) in the ACCMODE register (see Table 15).

Table 15. Inputs to Watt-Hour Accumulation Registers

CONSEL	AWATTHR	BWATTHR	CWATTHR
00	$VA \times IA$	$VB \times IB$	$VC \times IC$
01	$VA \times IA$	$VB \times IB$	$VC \times IC$
10	$VA \times IA$	$VB \times IB$ $VB = VA - VC^1$	$VC \times IC$
11	$VA \times IA$	$VB \times IB$ $VB = -VA - VC$ $VB = -VA$	$VC \times IC$

¹ In a 3-phase, 3-wire case (CONSEL[1:0] = 01), the device computes the rms value of the line voltage between Phase A and Phase C and stores the result in the BVRMS register (see the Voltage RMS in 3-Phase, 3-Wire Delta Configurations section). Consequently, the device computes powers associated with Phase B that do not have physical meaning. To avoid any errors in the frequency output pins (CF1, CF2, or CF3/HSCLK) related to the powers associated with Phase B, disable the contribution of Phase B to the energy-to-frequency converters by setting Bit TERMSEL1[1], Bit TERMSEL2[1], or Bit TERMSEL3[1] to 0 in the COMPMODE register (see the Energy to Frequency Conversion section).

Depending on the polyphase meter service, choose the appropriate formula to calculate the active energy. The American ANSI C12.10 standard defines the different configurations of the meter. Table 16 lists which mode to choose in these various configurations.

Table 16. Meter Form Configuration

ANSI Meter Form	Configuration	CONSEL[1:0]
5S/13S	3-wire delta	01
6S/14S	4-wire wye	10
8S/15S	4-wire delta	11
9S/16S	4-wire wye	00

Bits[1:0] (WATTACC[1:0]) in the ACCMODE register determines how the CF frequency output can be generated as a function of the total and fundamental active powers. Whereas the watt-hour accumulation registers accumulate the active power in a signed format, the frequency output can be generated in either signed mode or absolute mode as a function of the WATTACC[1:0] bits. See the Energy to Frequency Conversion section for more information.

Line Cycle Active Energy Accumulation Mode

In line cycle active energy accumulation mode, the energy accumulation synchronizes to the voltage channel zero crossings such that active energy accumulates over an integral number of half line cycles. The advantage of summing the active energy over an integer number of line cycles is that the sinusoidal component in the active energy is reduced to 0. This eliminates any ripple in the energy calculation and allows the energy to accumulate accurately over a shorter time. Using the line cycle energy accumulation mode greatly simplifies energy calibration and significantly reduces meter calibration time.

In line cycle energy accumulation mode, the ADE7854A/ADE7858A/ADE7868A/ADE7878A transfer the active energy accumulated in the 32-bit internal accumulation registers into the xWATTHR or xFWATTHR registers after an integral number of

line cycles, as shown in Figure 73. The LINECYC register specifies the number of half line cycles.

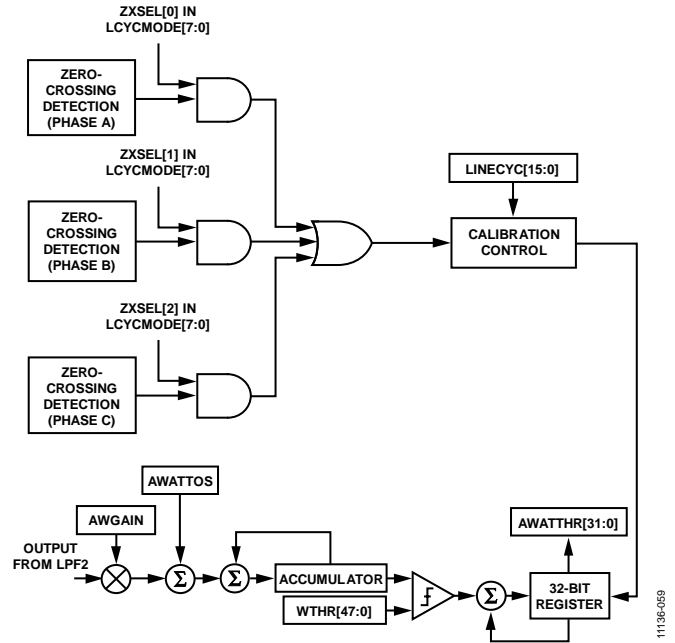

Figure 73. Line Cycle Active Energy Accumulation Mode

Setting Bit 0 (LWATT) in the LCYCMODE register activates the line cycle active energy accumulation mode. After LINECYC detects the number of half line cycles, the energy accumulation over an integer number of half line cycles is written to the watt-hour accumulation registers. When using the line cycle accumulation mode, set Bit 6 (RSTREAD) of the LCYCMODE to Logic 0 because the read with reset of watt-hour registers is not available in this mode.

Phase A, Phase B, and Phase C zero crossings are included when counting the number of half line cycles by setting Bits[5:3] (ZXSEL[x]) in the LCYCMODE register. Any combination of the zero crossings from all three phases can be used for counting the zero crossing. Select only one phase at a time for inclusion in the zero-crossing count during calibration.

The LINECYC 16-bit unsigned register specifies the number of zero crossings. The ADE7854A/ADE7858A/ADE7868A/ADE7878A can accumulate active power for up to 65,535 combined zero crossings. Note that the internal zero-crossing counter is always active. By setting Bit 0 (LWATT) in the LCYCMODE register, the first energy accumulation result is, therefore, incorrect. Writing to the LINECYC register when the LWATT bit is set resets the zero-crossing counter, thus ensuring that the first energy accumulation result is accurate.

At the end of an energy calibration cycle, Bit 5 (LENERGY) in the STATUS0 register is set. If the corresponding mask bit in the MASK0 interrupt mask register is enabled, the IRQ0 pin goes active low. Writing to the STATUS0 register with the corresponding bit set to 1 clears the status bit and resets the IRQ0 pin to high. Because the active power is integrated on an integer number of half line cycles in this mode, the sinusoidal

components are reduced to 0, eliminating any ripple in the energy calculation. Therefore, total energy accumulated using the line cycle accumulation mode is

$$e = \int_t^{t+nT} p(t) dt = nT \sum_{k=1}^{\infty} V_k I_k \cos(\varphi_k - \gamma_k) \quad (34)$$

where nT is the accumulation time.

Note that line cycle active energy accumulation uses the same signal path as the active energy accumulation. The LSB size of these two methods is equivalent.

REACTIVE POWER CALCULATION—ADE7858A, ADE7868A, ADE7878A ONLY

The ADE7858A/ADE7868A/ADE7878A can compute the total reactive power on every phase. Total reactive power integrates all fundamental and harmonic components of the voltages and currents. The ADE7878A also computes the fundamental reactive power, the power determined only by the fundamental components of the voltages and currents.

A load that contains a reactive element (inductor or capacitor) produces a phase difference between the applied ac voltage and the resulting current. VAR is the unit for the power associated with reactive elements (the reactive power). Reactive power is defined as the product of the voltage and current waveforms when all harmonic components of one of these signals are phase shifted by 90°.

Equation 38 is the expression for the instantaneous reactive power signal in an ac system when the phase of the current channel is shifted by 90°.

$$v(t) = \sum_{k=1}^{\infty} V_k \sqrt{2} \sin(k\omega t + \varphi_k) \quad (35)$$

$$i(t) = \sum_{k=1}^{\infty} I_k \sqrt{2} \sin(k\omega t + \gamma_k) \quad (36)$$

$$i'(t) = \sum_{k=1}^{\infty} I_k \sqrt{2} \sin\left(k\omega t + \gamma_k + \frac{\pi}{2}\right) \quad (37)$$

where $i'(t)$ is the current waveform with all harmonic components phase shifted by 90°.

Next, the instantaneous reactive power, $q(t)$, can be expressed as

$$\begin{aligned} q(t) &= v(t) \times i'(t) \\ q(t) &= \sum_{k=1}^{\infty} V_k I_k \times 2 \sin(k\omega t + \varphi_k) \times \sin\left(k\omega t + \gamma_k + \frac{\pi}{2}\right) + \\ &\sum_{\substack{k,m=1 \\ k \neq m}}^{\infty} V_k I_m \times 2 \sin(k\omega t + \varphi_k) \times \sin\left(m\omega t + \gamma_m + \frac{\pi}{2}\right) \end{aligned} \quad (38)$$

Note that $q(t)$ can be rewritten as

$$\begin{aligned} q(t) &= \sum_{k=1}^{\infty} V_k I_k \left\{ \cos\left(\varphi_k - \gamma_k - \frac{\pi}{2}\right) - \cos\left(2k\omega t + \varphi_k + \gamma_k + \frac{\pi}{2}\right) \right\} + \\ &\sum_{\substack{k,m=1 \\ k \neq m}}^{\infty} V_k I_m \left\{ \cos\left[(k-m)\omega t + \varphi_k - \gamma_k - \frac{\pi}{2}\right] - \right. \\ &\left. \cos\left[(k+m)\omega t + \varphi_k + \gamma_k + \frac{\pi}{2}\right] \right\} \end{aligned} \quad (39)$$

Equation 40 expresses the average total reactive power over an integral number of line cycles (n).

$$Q = \frac{1}{nT} \int_0^{nT} q(t) dt = \sum_{k=1}^{\infty} V_k I_k \cos\left(\varphi_k - \gamma_k - \frac{\pi}{2}\right) \quad (40)$$

$$Q = \sum_{k=1}^{\infty} V_k I_k \sin(\varphi_k - \gamma_k)$$

where:

T is the period of the line cycle.

Q is the total reactive power.

Note that the total reactive power is equal to the dc component of the instantaneous reactive power signal $q(t)$ in Equation 39, that is,

$$\sum_{k=1}^{\infty} V_k I_k \sin(\varphi_k - \gamma_k)$$

This is the relationship used to calculate the total reactive power in the ADE7858A/ADE7868A/ADE7878A for each phase. The instantaneous reactive power signal, $q(t)$, is generated by multiplying each harmonic of the voltage signals by the 90° phase shifted corresponding harmonic of the current in each phase.

The ADE7858A/ADE7868A/ADE7878A store the instantaneous total phase reactive powers in the AVAR, BVAR, and CVAR registers. Their expression is

$$xVAR = \sum_{k=1}^{\infty} \frac{V_k}{V_{FS}} \times \frac{I_k}{I_{FS}} \times \sin(\varphi_k - \gamma_k) \times PMAX \times \frac{1}{2^4} \quad (41)$$

where:

V_{FS} , I_{FS} are the rms values of the phase voltage and current when the ADC inputs are at full scale.

$PMAX = 33,516,139$, which is the instantaneous power computed when the ADC inputs are at full scale and in phase.

The xVAR waveform registers can be accessed using various serial ports. For more information, see the Waveform Sampling Mode section.

As described in the Active Power Calculation section, use the LPFSEL bit in the CONFIG_A register to increase the filtering on the power measurement. The LPFSEL bit is 0 by default and when set to 1, the strength of the power filtering increases (see Figure 68 and Figure 69). This filtering affects both the total active and the total reactive power measurements.

The expression of fundamental reactive power is obtained from Equation 40 with $k = 1$, as follows:

$$FQ = V_1 I_1 \sin(\varphi_1 - \gamma_1) \quad (42)$$

The ADE7878A computes the fundamental reactive power using a proprietary algorithm that requires some initialization function of the frequency of the network and its nominal voltage measured in the voltage channel. These initializations are common for both fundamental active and reactive powers (see the Active Power Calculation section).

Table 17 presents the settling time for the fundamental reactive power measurement, which is the time it takes the power to reflect the value at the input of the ADE7878A.

Table 17. Settling Times for Fundamental Reactive Power

63% Full-Scale Input Signals	100% Full-Scale Input Signals
375 ms	875 ms

Reactive Power Gain Calibration

Scale the average reactive power in each phase by ±100% by writing to one of the VAR gain 24-bit registers (AVARGAIN, BVARGAIN, CVARGAIN, AFVARGAIN, BFVARGAIN, or CFVARGAIN) of the phase. The xVARGAIN registers are placed in each phase of the total reactive power datapath, and the xFVARGAIN registers are placed in each phase of the fundamental reactive power datapath. The xVARGAIN registers are twos complement signed registers and have a resolution of 2⁻²³/LSB. The function of the xVARGAIN registers is expressed by

$$Average\ Reactive\ Power = LPF2Output \times \left(1 + \frac{xVARGAIN\ Register}{2^{23}} \right) \quad (43)$$

The output is scaled by -50% by writing 0xC00000 to the xVARGAIN registers and increased by +50% by writing 0x400000 to them. Use these registers to calibrate the reactive power (or energy) gain in the device for each phase.

As stated in the Current Waveform Gain Registers section, the serial ports of the ADE7858A/ADE7868A/ADE7878A work on 32-, 16-, or 8-bit words and the DSP works on 28 bits. Similar to registers shown in Figure 34, the AVARGAIN, BVARGAIN, CVARGAIN, AFVARGAIN, BFVARGAIN, and CFVARGAIN 24-bit signed registers are accessed as 32-bit registers with the four MSBs padded with 0s and sign extended to 28 bits.

Reactive Power Offset Calibration

The ADE7858A/ADE7868A/ADE7878A provide a reactive power offset register on each phase and on each reactive power. The AVAROS, BVAROS, and CVAROS registers compensate the offsets in the total reactive power calculations, whereas the AFVAROS, BFVAROS, and CFVAROS registers compensate offsets in the fundamental reactive power calculations. These signed, twos complement, 24-bit registers remove offsets in the reactive power calculations. An offset can exist in the power calculation due to crosstalk between channels on the PCB or in the chip itself. The offset resolution of the registers is the same as that of the active power offset registers (see the Active Power Offset Calibration section).

As stated in the Current Waveform Gain Registers section, the serial ports of the ADE7858A/ADE7868A/ADE7878A work on

32-, 16-, or 8-bit words and the DSP works on 28 bits. Similar to the registers shown in Figure 34, the AVAROS, BVAROS, CVAROS, AFVAROS, BFVAROS, and CFVAROS 24-bit signed registers are accessed as 32-bit registers with the four MSBs padded with 0s and sign extended to 28 bits.

Sign of Reactive Power Calculation

Note that the reactive power is a signed calculation. Table 18 summarizes the relationship between the phase difference between the voltage and the current, and the sign of the resulting reactive power calculation.

Table 18. Sign of Reactive Power Calculation

Φ ¹ (Degrees)	Integrator	Sign of Reactive Power
Between 0 to +180	Off	Positive
Between -180 to 0	Off	Negative
Between 0 to +180	On	Positive
Between -180 to 0	On	Negative

¹ Φ is defined as the phase angle of the voltage signal minus the current signal; that is, Φ is positive when the load is inductive and negative when the load is capacitive.

The ADE7858A/ADE7868A/ADE7878A have sign detection circuitry for reactive power calculations that monitor the total reactive powers or the fundamental reactive powers. As described in the Reactive Energy Calculation section, the reactive energy accumulation executes in two stages. Every time a sign change is detected in the energy accumulation at the end of the first stage, that is, after the energy accumulated into the internal accumulator reaches the VARTHRESH register threshold, a dedicated interrupt is triggered. Read the sign of each phase reactive power in the PHSIGN register. Bit 7 (REVRPSEL) in the ACCMODE register sets the type of reactive power to be monitored. Setting REVRPSEL to 0 (the default value) monitors the total reactive power, whereas setting REVRPSEL to 1 monitors the fundamental reactive power.

A sign change occurring in the power selected by Bit 7 (REVRPSEL) in the ACCMODE register sets Bits[12:10] (REVRPC, REVRPB, and REVRPA, respectively) in the STATUS0 register.

Bits[6:4] (CVARSIGN, BVARSIGN, and AVARSIGN, respectively) in the PHSIGN register set simultaneously with the REVRPC, REVRPB, and REVRPA bits. They indicate the sign of the reactive power. When these bits are set to 0, the reactive power is positive. When these bits are set to 1, the reactive power is negative.

Bit REVRPx of the STATUS0 register and Bit xVARSIGN in the PHSIGN register refer to the reactive power of Phase x, the power type selected by Bit REVRPSEL in the ACCMODE register.

Setting Bits[12:10] in the MASK0 register enables the REVRPC, REVRPB, and REVRPA interrupts, respectively. When enabled, the IRQ0 pin is set low and the status bit is set to 1 whenever a change of sign occurs. To find the phase that triggered the interrupt, read the PHSIGN register immediately after reading the STATUS0 register. Next, write to the STATUS0 register with

the corresponding bit set to 1 to clear the status bit and to set the $\overline{\text{IRQ0}}$ pin to high.

Reactive Energy Calculation

Reactive energy is defined as the integral of reactive power.

$$\text{Reactive Energy} = \int q(t)dt \quad (44)$$

Both total and fundamental reactive energy accumulations are always a signed operation. Negative energy is subtracted from the reactive energy contents.

Similar to active power, the [ADE7858A/ADE7868A/ADE7878A](#) achieve the integration of the reactive power signal in two stages (see Figure 74). The process is identical for both total and fundamental reactive powers.

- The first stage is conducted inside the DSP: every 125 μs (8 kHz frequency), the instantaneous phase total reactive or fundamental power is accumulated into an internal register. When a threshold is reached, a pulse is generated at the processor port and the threshold is subtracted from the internal register. The sign of the energy in this moment is considered the sign of the reactive power (for more information, see the Sign of Reactive Power Calculation section).
- The second stage is performed outside the DSP and consists of accumulating the pulses generated by the processor into internal 32-bit accumulation registers. The content of these registers is transferred to the VAR-hour registers (xVARHR and xFVARHR) when these registers are accessed. AVARHR, BVARHR, CVARHR, AFWATTHR, BFWATTHR, and CFWATTHR represent phase fundamental reactive powers.

Figure 70 in the Active Energy Calculation section explains this process. The VARTHR combined 48-bit signed register contains the threshold introduced by the user; it is common for both total and fundamental phase reactive powers. Its value depends on how much energy is assigned to one LSB of var-hour registers.

When a derivative of reactive energy (varh) of $[10^n \text{ varh}]$, where n is an integer, is desired as one LSB of the xVARHR register; then, the VARTHR register can be computed using the following equation:

$$\text{VARTHR} = \frac{P_{\text{MAX}} \times f_s \times 3600 \times 10^n}{V_{\text{FS}} \times I_{\text{FS}}} \quad (45)$$

where:

$P_{\text{MAX}} = 33,516,139 = 0x1FF6A6B$, which is the instantaneous power computed when the ADC inputs are at full scale.

$f_s = 8 \text{ kHz}$, the frequency with which the DSP computes the instantaneous power.

$V_{\text{FS}}, I_{\text{FS}}$ are the rms values of phase voltages and currents when the ADC inputs are at full scale.

The maximum value that may be written on the VARTHR register is $2^{47} - 1$. The minimum value is $0x0$; however, it is best to write a number equal to or greater than P_{MAX} . Never use negative numbers.

Similar to the WTHR register (see Figure 72), VARTHR, a 48-bit register, is accessed as two 32-bit registers (VARTHR1 and VARTHR0), each having eight MSBs padded with 0s. As previously stated in the Voltage Waveform Gain Registers section, the serial ports of the [ADE7858A/ADE7868A/ADE7878A](#) work on 32-, 16-, or 8-bit words.

This discrete time accumulation or summation is equivalent to integration in continuous time as shown in Equation 46.

$$\text{Reactive Energy} = \int q(t)dt = \lim_{T \rightarrow 0} \left\{ \sum_{n=0}^{\infty} q(nT) \times T \right\} \quad (46)$$

where:

n is the discrete time sample number.

T is the sample period.

On the [ADE7858A/ADE7868A/ADE7878A](#), the total phase reactive powers accumulate in the AVARHR, BVARHR, and CVARHR 32-bit signed registers. The fundamental phase reactive powers accumulate in the AFWARHR, BFWARHR, and CFVARHR 32-bit signed registers. The reactive energy register content can roll over to full-scale negative ($0x80000000$) and continue increasing in value when the reactive power is positive. Conversely, when the reactive power is negative, the energy register underflows to full-scale positive ($0x7FFFFFFF$) and continues to decrease in value.

Bit 2 (REHF) in the STATUS0 register is set when Bit 30 of one of the xVARHR registers changes, signifying one of these registers is half full. When the reactive power is positive, the var-hour register becomes half full when it increments from $0x3FFFFFFF$ to $0x40000000$. When the reactive power is negative, the var-hour register becomes half full when it decrements from $0xC0000000$ to $0xBFFFFFFF$. Analogously, Bit 3 (FREHF) in the STATUS0 register is set when Bit 30 of one of the xFVARHR registers changes, signifying that one of these registers is half full.

Setting Bits[3:2] in the MASK0 register enable the FREHF and REHF interrupts, respectively. When enabled, the $\overline{\text{IRQ0}}$ pin is set low and the status bit is set to 1 whenever one of the energy registers, xVARHR (for REHF interrupt) or xFVARHR (for FREHF interrupt), becomes half full. Writing to the STATUS0 register with the corresponding bit set to 1 clears the status bit and sets the $\overline{\text{IRQ0}}$ pin to high.

Setting Bit 6 (RSTREAD) of the LCYCMODE register enables a read with reset for all var-hour accumulation registers, that is, the registers are reset to 0 after a read operation.

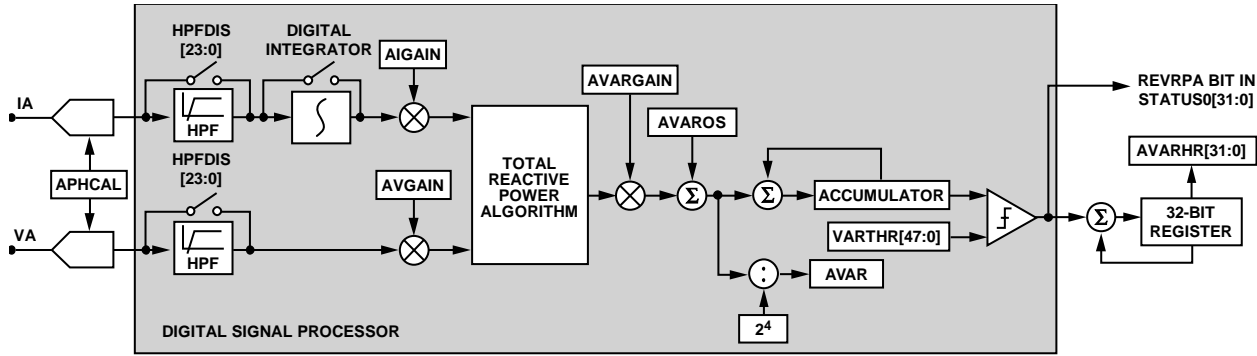

Figure 74. Total Reactive Energy Accumulation

Integration Time Under Steady Load

The discrete time sample period (T) for the accumulation register is 125 μs (8 kHz frequency). With full-scale pure sinusoidal signals on the analog inputs and a 90° phase difference between the voltage and the current signal (the largest possible reactive power), the average word value representing the reactive power is P_{MAX} = 33,516,139 = 0x1FF6A6B. Setting the VARTHR threshold at the P_{MAX} level means that the DSP generates a pulse that is added at the var-hour registers every 125 μs.

The maximum value that can be stored in the var-hour accumulation register before it overflows is 2³¹ – 1 or 0x7FFFFFFF. The integration time is calculated as

$$Time = 0x7FFFFFFF \times 125 \mu s = 74 \text{ hr, } 33 \text{ min, } 55 \text{ sec} \quad (47)$$

Energy Accumulation Modes

The reactive power accumulated in each var-hour accumulation 32-bit register (AVARHR, BVARHR, CVARHR, AFVARHR, BFVARHR, and CFVARHR) depends on the configuration of Bits[5:4] (CONSEL[1:0]) in the ACCMODE register, in correlation with the watt-hour registers. The different configurations are listed in Table 19. Note that IA’/IB’/IC’ are the phase shifted current waveforms.

Table 19. Inputs to Var-Hour Accumulation Registers

CONSEL[1:0]	AVARHR, AFVARHR	BVARHR, BFVARHR	CVARHR, CFVARHR
00	VA × IA’	VB × IB’	VC × IC’
01	VA × IA’	VB × IB’ VB = VA – VC ¹	VC × IC’
10	VA × IA’	VB × IB’ VB = –VA – VC	VC × IC’
11	VA × IA’	VB × IB’ VB = –VA	VC × IC’

¹In a 3-phase, 3-wire case (CONSEL[1:0] = 01), the device computes the rms value of the line voltage between Phase A and Phase C and stores the result into BVRMS register (see the Voltage RMS in 3-Phase, 3-Wire Delta Configurations section). Consequently, the device computes powers associated with Phase B that do not have physical meaning. To avoid any errors in the frequency output pins (CF1, CF2, or CF3/HSCLK) related to the powers associated with Phase B, disable the contribution of Phase B to the energy to frequency converters by setting Bit TERMSSEL1[1], Bit TERMSSEL2[1], or Bit TERMSSEL3[1] to 0 in the COMPMODE register (see the Energy to Frequency Conversion section).

Bits[3:2] (VARACC[1:0]) in the ACCMODE register determine how the CFx frequency output can be a generated function of the total and fundamental reactive powers. Whereas the var-hour accumulation registers accumulate the reactive power in a signed format, the frequency output can be generated in either the signed mode, the sign adjusted mode, or the absolute mode by setting the appropriate bits in VARACC[1:0]. See the Energy to Frequency Conversion section for more information.

Line Cycle Reactive Energy Accumulation Mode

In line cycle energy accumulation mode (see the Line Cycle Active Energy Accumulation Mode section), the energy accumulation can be synchronized to the voltage channel zero crossings to accumulate reactive energy over an integral number of half line cycles.

In this mode, the ADE7858A/ADE7868A/ADE7878A transfer the reactive energy accumulated in the 32-bit internal accumulation registers into the xVARHR or xFVARHR registers after an integral number of line cycles, as shown in Figure 75. The LINECYC register specifies the number of half line cycles.

Setting Bit 1 (LVAR) in the LCYCMODE register activates the line cycle reactive energy accumulation mode. The total reactive energy accumulated over an integer number of half line cycles or zero crossings is available in the var-hour accumulation registers after the number of zero crossings specified in the LINECYC register is detected. When using the line cycle accumulation mode, set Bit 6 (RSTREAD) of the LCYCMODE register to Logic 0 because a read with a reset of var-hour registers is not available in this mode.



Figure 75. Line Cycle Total Reactive Energy Accumulation Mode

Phase A, Phase B, and Phase C zero crossings are included when counting the number of half line cycles by setting Bits[5:3] (ZXSEL[x]) in the LCYCMODE register. Any combination of the zero crossings from all three phases can be used for counting the zero crossing. Select only one phase at a time for inclusion in the zero-crossings count during calibration.

For more information about setting the LINECYC register and Bit 5 (LENERGY) in the MASK0 interrupt mask register associated with the line cycle accumulation mode, see the Line Cycle Active Energy Accumulation Mode section.

APPARENT POWER CALCULATION

Apparent power is defined as the maximum power that can be delivered to a load. One way to obtain the apparent power is by multiplying the voltage rms value by the current rms value (the arithmetic apparent power)

$$S = V_{rms} \times I_{rms} \tag{48}$$

where:

S is the apparent power.

V_{rms} and I_{rms} are the rms voltage and current, respectively.

The ADE7854A/ADE7858A/ADE7868A/ADE7878A compute the arithmetic apparent power on each phase. Figure 76 illustrates the signal processing in each phase for the calculation of the apparent power in the ADE7854A/ADE7858A/ADE7868A/ADE7878A. Because V_{rms} and I_{rms} contain all harmonic information, the apparent power computed by the device is total apparent power. Note that the ADE7878A does not compute fundamental apparent power because it does not measure the rms values of the fundamental voltages and currents.

The ADE7854A/ADE7858A/ADE7868A/ADE7878A store the instantaneous phase apparent powers in the AVA, BVA, and CVA registers, expressed as

$$xVA = \frac{V}{V_{FS}} \times \frac{I}{I_{FS}} \times P_{MAX} \times \frac{1}{2^4} \tag{49}$$

where:

V, I are the rms values of the phase voltage and current, respectively.

V_{FS}, I_{FS} are the rms values of the phase voltage and current when the ADC inputs are at full scale.

P_{MAX} = 33,516,139, which is the instantaneous power computed when the ADC inputs are at full scale and in phase.

Note that the xVA[23:0] waveform registers are accessible through various serial ports (see the Waveform Sampling Mode section).

The ADE7854A/ADE7858A/ADE7868A/ADE7878A can compute the apparent power in an alternative way by multiplying the phase rms current by an rms voltage introduced externally (see the Apparent Power Calculation Using V_{NOM} section).

Apparent Power Gain Calibration

The average apparent power result in each phase can be scaled by ±100% by writing to the respective xVAGAIN 24-bit register (AVAGAIN, BVAGAIN, or CVAGAIN).

The xVAGAIN registers are two's complement, signed registers and have a resolution of 2⁻²³/LSB. The function of the xVAGAIN registers is expressed mathematically as

$$\begin{aligned} \text{Average Apparent Power} = \\ V_{rms} \times I_{rms} \times \left(1 + \frac{xVAGAIN \text{ Register}}{2^{23}} \right) \end{aligned} \tag{50}$$

where x represents the A, B, or C phase.

The output is scaled by -50% by writing 0xC00000 to the xVAGAIN registers, and it is increased by +50% by writing 0x400000 to them. These registers calibrate the apparent power (or energy) calculation in the ADE7854A/ADE7858A/ADE7868A/ADE7878A for each phase.

As previously stated in the Current Waveform Gain Registers section, the serial ports of the ADE7854A/ADE7858A/ADE7868A/ADE7878A work on 32-, 16-, or 8-bit words and the DSP works on 28 bits. Similar to the registers shown in Figure 34, the AVAGAIN, BVAGAIN, and CVAGAIN 24-bit registers are accessed as 32-bit registers with the four MSBs padded with 0s and sign extended to 28 bits.

Apparent Power Offset Calibration

Each rms measurement includes an offset compensation register to calibrate and eliminate the dc component in the rms value (see the Root Mean Square Measurement section). The voltage and current rms values are multiplied together in the apparent power signal processing. Because no additional offsets are created in the multiplication of the rms values, there is no specific offset compensation in the apparent power signal processing. The offset compensation of the apparent power measurement in each phase is accomplished by calibrating each individual rms measurement.

Apparent Power Calculation Using VNOM

The ADE7854A/ADE7858A/ADE7868A/ADE7878A can compute the apparent power by multiplying the phase rms current by an rms voltage introduced externally in the VNOM 24-bit signed register. When one of Bits[13:11] (VNOMCEN, VNOMBEN, or VNOMAEN) in the COMPMODE register is set to 1, the apparent power in the corresponding phase (Phase x for VNOMxEN) is computed in this way. Clearing the VNOMxEN bits to 0 (the default value) computes the arithmetic apparent power.

The VNOM register contains a number determined by V, the desired rms voltage, and V_{FS}, the rms value of the phase voltage when the ADC inputs are at full scale:

$$VNOM = \frac{V}{V_{FS}} \times 4,191,910 \tag{51}$$

where V is the desired nominal phase rms voltage.

As stated in the Current Waveform Gain Registers section, the serial ports of the ADE7854A/ADE7858A/ADE7868A/ADE7878A work on 32-, 16-, or 8-bit words. Similar to the register shown in Figure 37, the VNOM 24-bit signed register is accessed as a 32-bit register with the eight MSBs padded with 0s.

Apparent Energy Calculation

Apparent energy is defined as the integral of apparent power.

$$Apparent\ Energy = \int s(t) dt \tag{52}$$

Similar to active and reactive powers, the ADE7854A/ADE7858A/ADE7868A/ADE7878A achieve the integration of the apparent power signal in two stages (see Figure 76).

The first stage is conducted inside the DSP: every 125 μs (8 kHz frequency), the instantaneous phase apparent power accumulates into an internal register. When a threshold is reached, a pulse is generated at the processor port and the threshold is subtracted from the internal register.

The second stage is conducted outside the DSP and consists of accumulating the pulses generated by the processor into internal 32-bit accumulation registers. When these registers are accessed, the contents of these registers transfer to the VA-hour

registers, xVAHR (see Figure 71 from the Active Energy Calculation section).

The VATHR 48-bit register contains the threshold. Its value depends on how much energy is assigned to 1 LSB of the VA-hour registers. When a derivative of apparent energy (VAh) of [10ⁿ VAh], where n is an integer, is desired as 1 LSB of the xVAHR register, compute the VATHR register using the following equation:

$$VATHR = \frac{P_{MAX} \times f_s \times 3600 \times 10^n}{V_{FS} \times I_{FS}} \tag{53}$$

where:

P_{MAX} = 33,516,139 = 0x1FF6A6B, the instantaneous power computed when the ADC inputs are at full scale.

f_s = 8 kHz, the frequency with which the DSP computes the instantaneous power.

V_{FS}, I_{FS} are the rms values of phase voltages and currents when the ADC inputs are at full scale.

VATHR is a 48-bit register. As previously stated in the Current Waveform Gain Registers section, the serial ports of the ADE7854A/ADE7858A/ADE7868A/ADE7878A work on 32-, 16-, or 8-bit words. Similar to the WTHR register as shown in Figure 72, the VATHR register is accessed as two 32-bit registers (VATHR1 and VATHR0), each having eight MSBs padded with 0s.

This discrete time accumulation or summation is equivalent to integration in continuous time as shown in Equation 54.

$$Apparent\ Energy = \int s(t)dt = \lim_{T \rightarrow 0} \left\{ \sum_{n=0}^{\infty} s(nT) \times T \right\} \tag{54}$$

where:

n is the discrete time sample number.

T is the sample period.

In the ADE7854A/ADE7858A/ADE7868A/ADE7878A, the phase apparent powers are accumulated in the AVAHR, BVAHR, and CVAHR 32-bit signed registers. When the apparent power is positive, the apparent energy register content can roll over to full-scale negative (0x80000000) and continue increasing in value.

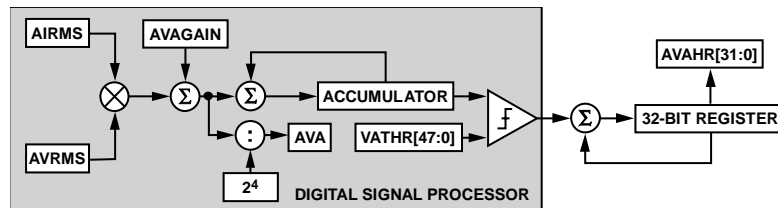

Figure 76. Apparent Power Data Flow and Apparent Energy Accumulation

11136-02

Bit 4 (VAEHF) in the STATUS0 register is set when Bit 30 of one of the xVAHR registers changes, signifying one of these registers is half full. Because the apparent power is always positive and the xVAHR registers are signed, the VA-hour registers become half full when they increment from 0x3FFFFFFF to 0x40000000. Enable interrupts that are attached to Bit VAEHF in the STATUS0 register by setting Bit 4 in the MASK0 register. Enabling sets the IRQ0 pin to low and sets the status bit to 1 whenever one of the Energy Registers xVAHR becomes half full. Writing to the STATUS0 register with the corresponding bit set to 1 clears the status bit and sets the IRQ0 pin to high.

Setting Bit 6 (RSTREAD) of the LCYCMODE register enables a read-with-reset for all xVAHR accumulation registers, that is, the registers are reset to 0 after a read operation.

Integration Time Under Steady Load

The discrete time sample period for the accumulation register is 125 μs (8 kHz frequency). With full-scale pure sinusoidal signals on the analog inputs, the average word value representing the apparent power is P_{MAX}. Setting the VATHR threshold register at the P_{MAX} level means that the DSP generates a pulse that is added at the xVAHR registers every 125 μs.

The maximum value that can be stored in the xVAHR accumulation register before it overflows is 2³¹ – 1 or 0x7FFFFFFF. Calculate the integration time as

$$Time = 0x7FFFFFFF \times 125 \mu s = 74 \text{ hr, } 33 \text{ min, } 55 \text{ sec} \quad (55)$$

Energy Accumulation Mode

The amount of apparent power that accumulates in each accumulation register depends on the configuration of Bits[5:4] (CONSEL[1:0]) in the ACCMODE register. See Table 20 for the various configurations of inputs to the VA-hour accumulation registers.

Table 20. Inputs to VA-Hour Accumulation Registers

CONSEL[1:0]	AVAHR	BVAHR	CVAHR
00	VA rms × IA rms	VB rms × IB rms	VC rms × IC rms
01	VA rms × IA rms	VB rms × IB rms VB = VA – VC ¹	VC rms × IC rms
10	VA rms × IA rms	VB rms × IB rms VB = –VA – VC	VC rms × IC rms
11	VA rms × IA rms	VB rms × IB rms VB = –VA	VC rms × IC rms

¹In a 3-phase, 3-wire case (CONSEL[1:0] = 01), the device computes the rms value of the line voltage between Phase A and Phase C and stores the result in the BVRMS register (see the Voltage RMS in 3-Phase, 3-Wire Delta Configurations section). Consequently, the device computes powers associated with Phase B that do not have physical meaning. To avoid any errors in the frequency output pins (CF1, CF2, or CF3/HSCLK) related to the powers associated with Phase B, disable the contribution of Phase B to the energy to frequency converters by setting Bit TERMSEL1[1], Bit TERMSEL2[1], or Bit TERMSEL3[1] to 0 in the COMPMODE register (see the Energy to Frequency Conversion section).

Line Cycle Apparent Energy Accumulation Mode

In line cycle energy accumulation mode, it is possible to synchronize the energy accumulation to the voltage channel zero crossings, allowing apparent energy to be accumulated over an integral number of half line cycles (see the Line Cycle Active Energy Accumulation Mode section). In this mode, the ADE7854A/ADE7858A/ADE7868A/ADE7878A transfer the apparent energy accumulated in the 32-bit internal accumulation registers into the xVAHR registers after an integral number of line cycles, as shown in Figure 77. The LINECYC register specifies the number of half line cycles.

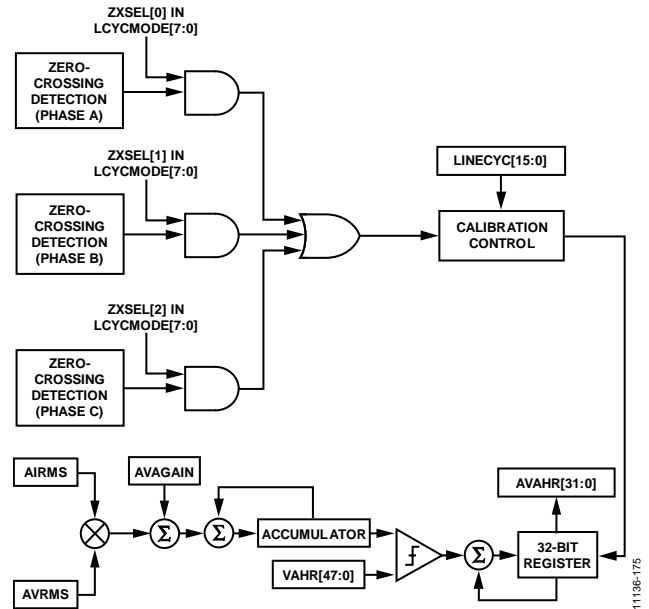

Figure 77. Line Cycle Apparent Energy Accumulation Mode

The line cycle apparent energy accumulation mode is activated by setting Bit 2 (LVA) in the LCYCMODE register. The apparent energy accumulated over an integer number of zero crossings is written to the xVAHR accumulation registers after the number of zero crossings specified in LINECYC register is detected. When using the line cycle accumulation mode, set Bit 6 (RSTREAD) of the LCYCMODE register to Logic 0 because a read with the reset of xVAHR registers is not available in this mode.

Phase A, Phase B, and Phase C zero crossings are, respectively, included when counting the number of half line cycles by setting Bits[5:3] (ZXSSEL[x]) in the LCYCMODE register. Any combination of the zero crossings from all three phases can be used for counting the zero crossing. Select only one phase at a time for inclusion in the zero-crossings count during calibration.

For more information about setting the LINECYC register and Bit 5 (LENERGY) in the MASK0 interrupt mask register associated with the line cycle accumulation mode, see the Line Cycle Active Energy Accumulation Mode section.

WAVEFORM SAMPLING MODE

The waveform samples of the current and voltage waveform, the active, reactive, and apparent power outputs are stored every 125 μs (8 kHz rate) into 24-bit signed registers that can be accessed through various serial ports of the [ADE7854A/ADE7858A/ADE7868A/ADE7878A](#). Table 21 provides a list of registers and their descriptions.

Table 21. Waveform Registers List

Register	Description
IWV	Phase A current
VAWV	Phase A voltage
IBWV	Phase B current
VBWV	Phase B voltage
ICWV	Phase C current
VCWV	Phase C voltage
INWV	Neutral current, available in the ADE7868A and ADE7878A only
AVA	Phase A apparent power
BVA	Phase B apparent power
CVA	Phase C apparent power
AWATT	Phase A total active power
BWATT	Phase B total active power
CWATT	Phase C total active power
AVAR	Phase A total reactive power
BVAR	Phase B total reactive power
CVAR	Phase C total reactive power

Bit 17 (DREADY) in the STATUS0 register can be used to signal when the registers listed in Table 21 can be read using I²C or SPI serial ports. An interrupt attached to the flag can be enabled by setting Bit 17 (DREADY) in the MASK0 register. For more information about the DREADY bit, see the Digital Signal Processor section.

The [ADE7854A/ADE7858A/ADE7868A/ADE7878A](#) contain a high speed data capture (HSDC) port that is specially designed to provide fast access to the waveform sample registers (see the HSDC Interface section). There is also an SPI burst mode available to access all waveform registers with one command (see the SPI Burst Read Operation section).

As stated in the Current Waveform Gain Registers section, the serial ports of the [ADE7854A/ADE7858A/ADE7868A/ADE7878A](#) work on 32-, 16-, or 8-bit words. All registers listed in Table 21 are transmitted sign-extended from 24 bits to 32 bits (see Figure 38).

ENERGY TO FREQUENCY CONVERSION

The [ADE7854A/ADE7858A/ADE7868A/ADE7878A](#) provide three frequency output pins: CF1, CF2, and CF3/HSCLK. The CF3 output is multiplexed with the serial clock output of the HSDC interface. When HSDC is enabled, the CF3 functionality is

disabled at the pin. The CF1 and CF2 pins are always available. Note that throughout this section, the CF3/HSCLK dual function pin name is referenced by the relevant calibration frequency output function only, CF3 (see the Pin Configuration and Function Descriptions section for full pin mnemonics and descriptions).

After initial calibration at manufacturing, the manufacturer or end user verifies the energy meter calibration. One convenient way to verify the meter calibration is to provide an output frequency proportional to the active, reactive, or apparent powers under steady load conditions. This output frequency can provide a simple, single-wire, optically isolated interface to external calibration equipment. Figure 78 illustrates the energy to frequency conversion in the [ADE7854A/ADE7858A/ADE7868A/ADE7878A](#).

The DSP computes the instantaneous values of all phase powers: total active, fundamental active, total reactive, fundamental reactive, and apparent. The process in which the energy is sign accumulated in various xWATTHR, xVARHR, and xVAHR registers is described in the energy calculation sections: Active Energy Calculation, Reactive Energy Calculation, and Apparent Energy Calculation. In the energy to frequency conversion process, the instantaneous powers generate signals at the frequency output pins (CF1, CF2, and CF3/HSCLK). One digital-to-frequency converter is used for every CFx pin. Every converter sums certain phase powers and generates a signal that is proportional to the sum. Two sets of bits determine which powers are converted.

First, Bits[2:0] (TERMSEL1[2:0]), Bits[5:3] (TERMSEL2[2:0]), and Bits[8:6] (TERMSEL3[2:0]) of the COMPMODE register determine which phases, or which combination of phases, are added.

The TERMSEL1 bits refer to the CF1 pin, the TERMSEL2 bits refer to the CF2 pin, and the TERMSEL3 bits refer to the CF3/HSCLK pin. The TERMSELx[0] bits manage Phase A. When set to 1, Phase A power is included in the sum of powers at the CFx converter. When cleared to 0, Phase A power is not included. The TERMSELx[1] bits manage Phase B, and the TERMSELx[2] bits manage Phase C. Setting all TERMSELx bits to 1 means that all 3-phase powers are added at the CFx converter. Clearing all TERMSELx bits to 0 means no phase power is added and no CF pulse is generated.

Second, Bits[2:0] (CF1SEL[2:0]), Bits[5:3] (CF2SEL[2:0]), and Bits[8:6] (CF3SEL[2:0]) in the CFMODE register decide what type of power is used at the inputs of the CF1, CF2, and CF3 converters, respectively. Table 22 shows the values that CFxSEL can have: total active, total reactive (available in the [ADE7858A](#), [ADE7868A](#), and [ADE7878A](#) only), apparent, fundamental active (available in the [ADE7878A](#) only), or fundamental reactive (available in the [ADE7878A](#) only) powers.

Table 22. Description of the CFxSEL[2:0] Bits in the CFMODE Register

CFxSEL[2:0]	CFx Signal Proportional to the Sum of	Registers Latched When CFxLATCH = 1
000	Total phase active powers	AWATTHR, BWATTHR, CWATTHR
001	Total phase reactive powers (ADE7858A, ADE7868A, and ADE7878A)	AVARHR, BVARHR, CVARHR
010	Phase apparent powers	AVAHR, BVAHR, CVAHR
011	Fundamental phase active powers (ADE7878A only)	AFWATTHR, BFWATTHR, CFWATTHR
100	Fundamental phase reactive powers (ADE7878A only)	AFVARHR, BFVARHR, CFVARHR
101 to 111	Reserved	



¹FWATT and FVAR for ADE7878A only.

Figure 78. Energy to Frequency Conversion

By default, the TERMSELx bits are all 1 and the CF1SEL bits are 000, the CF2SEL bits are 001, and the CF3SEL bits are 010. This means that, by default, the CF1 digital to frequency converter produces signals proportional to the sum of all 3-phase total active powers, CF2 produces signals proportional to total reactive powers, and CF3 produces signals proportional to apparent powers.

Similar to the energy accumulation process, the energy-to-frequency conversion is accomplished in two stages. In the first stage, the instantaneous phase powers obtained from the DSP at the 8 kHz rate are shifted left by seven bits and then accumulate into an internal register at a 1 MHz rate. When a threshold is reached, a pulse is generated and the threshold is subtracted from the internal register. The sign of the energy in this moment is considered the sign of the sum of phase powers (see the Sign of Sum-of-Phase Powers in the CFx Datapath section for more information). The threshold is the same threshold used in various active, reactive, and apparent energy accumulators in the DSP, such as the WTHR, VARTHR, or VATHR registers, except for being shifted left by seven bits. The advantage of accumulating the instantaneous powers at the 1 MHz rate is that the ripple at the CFx pins is greatly diminished.

The second stage consists of the frequency divider by the CFxDEN 16-bit unsigned registers. The values of CFxDEN depend on the meter constant (MC), measured in impulses/kWh and how much energy is assigned to one LSB of various energy registers: xWATTHR, xVARHR, and so forth. Supposing a derivative of wh [10ⁿ wh], where n is a positive or negative integer, desired as one LSB of the xWATTHR register, CFxDEN is

$$CFxDEN = \frac{10^3}{MC[\text{imp/kwh}] \times 10^n} \quad (56)$$

The derivative of wh must be chosen in such a way to obtain a CFxDEN register content greater than 1. If CFxDEN = 1, then the CFx pin stays active low for only 1 μs; therefore, avoid this number. The frequency converter cannot accommodate fractional results; the result of the division must be rounded to the nearest integer. If CFxDEN is set equal to 0, then the device considers it to be equal to 1.

The pulse output for all digital to frequency converters stays low for 80 ms if the pulse period is larger than 160 ms (6.25 Hz). When the pulse period is smaller than 160 ms and CFxDEN is an even number, the duty cycle of the pulse output is exactly 50%. When the pulse period is smaller than 160 ms and CFxDEN is an odd number, the duty cycle of the pulse output is

$$(1 + 1/CFxDEN) \times 50\%$$

The pulse output is active low and, preferably, connected to an LED (see Figure 79).

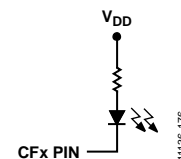

Figure 79. CFx Pin Recommended Connection

Use Bits[11:9] (CF3DIS, CF2DIS, and CF1DIS) of the CFMODE register to determine if the frequency converter output is generated at the CF3/HSCLK, CF2, or CF1 pin. Setting Bit CFxDIS to 1 (the default value) disables the CFx pin, and the pin stays high. Clearing Bit CFxDIS to 0 generates an active low signal on the output of the corresponding CFx pin.

Bits[16:14] (CF3, CF2, CF1) in the interrupt mask register, MASK0, manage the CF3, CF2, and CF1 related interrupts. When the

CFx bits are set, whenever a high-to-low transition at the corresponding frequency converter output occurs, an interrupt $\overline{IRQ0}$ is triggered and a status bit in the STATUS0 register is set to 1. The interrupt is available even if the CFx output is not enabled by the CFxDIS bits in the CFMODE register.

Synchronizing Energy Registers with the CFx Outputs

The ADE7854A/ADE7858A/ADE7868A/ADE7878A contain a feature that allows synchronizing the content of phase energy accumulation registers with the generation of a CFx pulse. When a high to low transition at one frequency converter output occurs, the content of all internal phase energy registers that relate to the power being output at CFx pin is latched into hour registers and then resets to 0. See Table 22 for the list of registers that are latched based on the CFxSEL[2:0] bits in the CFMODE register. All 3-phase registers are latched, independent of the TERMSELx bits of the COMPMODE register. The process is shown in Figure 80 for CF1SEL[2:0] = 010 (apparent powers contribute at the CF1 pin) and CFCYC = 2.

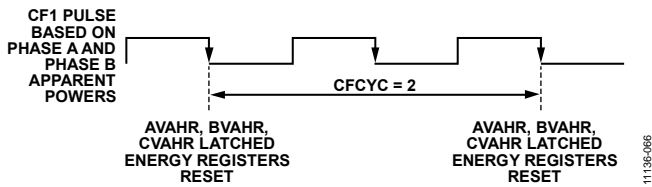

Figure 80. Synchronizing AVAHR and BVAHR with CF1

The CFCYC 8-bit unsigned register contains the number of high to low transitions at the frequency converter output between two consecutive latches. Avoid writing a new value into the CFCYC register during a high to low transition at any CFx pin.

Bits[14:12] (CF3LATCH, CF2LATCH, and CF1LATCH) of the CFMODE register enable this process when set to 1. When cleared to 0, the default state, no latch occurs. The process is available even when the CFx output is not enabled by the CFxDIS bits in the CFMODE register.

CFx Outputs for Various Accumulation Modes

Bits[1:0] (WATTACC[1:0]) in the ACCMODE register determine the accumulation modes of the total and fundamental active powers when signals proportional to the active powers are chosen at the CFx pins (the CFxSEL[2:0] bits in the CFMODE register equal 000 or 011). When WATTACC[1:0] = 00 (the default value), the active powers are sign accumulated before entering the energy to frequency converter. Figure 81 shows how signed active power accumulation functions. In this mode, the CFx pulses synchronize perfectly with the active energy accumulated in xWATTHR registers because the powers are sign accumulated in both datapaths.

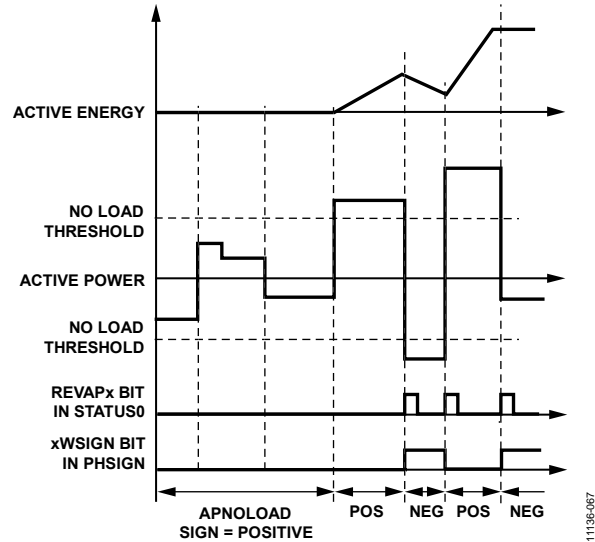

Figure 81. Active Power Signed Accumulation Mode

When WATTACC[1:0] = 11, the active powers accumulate in absolute mode. When the powers are negative, they change sign and accumulate together with the positive power. Figure 82 shows how absolute active power accumulation functions. Note that in this mode, the xWATTHR registers continue to accumulate active powers in signed mode, even when the CFx pulses are generated based on the absolute accumulation mode.

WATTACC[1:0] settings of 01 and 10 are reserved. The ADE7854A/ADE7858A/ADE7868A/ADE7878A behave identically to WATTACC[1:0] = 00.

Bits[3:2] (VARACC[1:0]) in the ACCMODE register determine the accumulation modes of the total and fundamental reactive powers when signals proportional to the reactive powers are chosen at the CFx pins (the CFxSEL[2:0] bits in the CFMODE register equal 001 or 100). When VARACC[1:0] = 00, the default value, the reactive powers are sign accumulated before entering the energy to frequency converter. Figure 83 shows how signed reactive power accumulation functions. In this mode, the CFx pulses synchronize perfectly with the reactive energy accumulated in the xVARHR registers because the powers are sign accumulated in both datapaths.

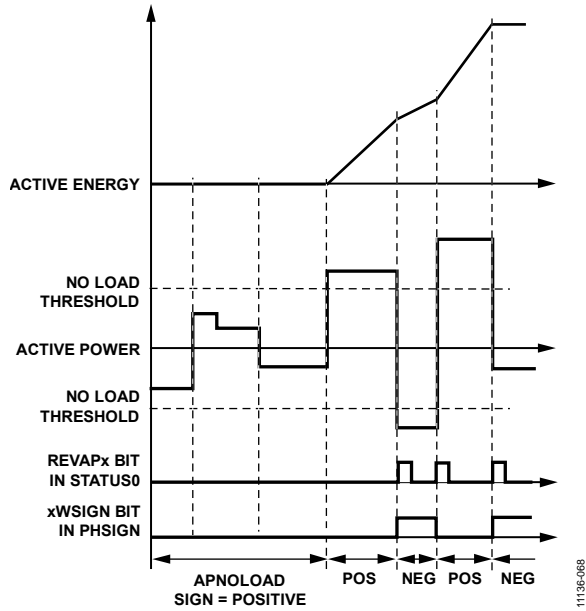

Figure 82. Active Power Absolute Accumulation Mode

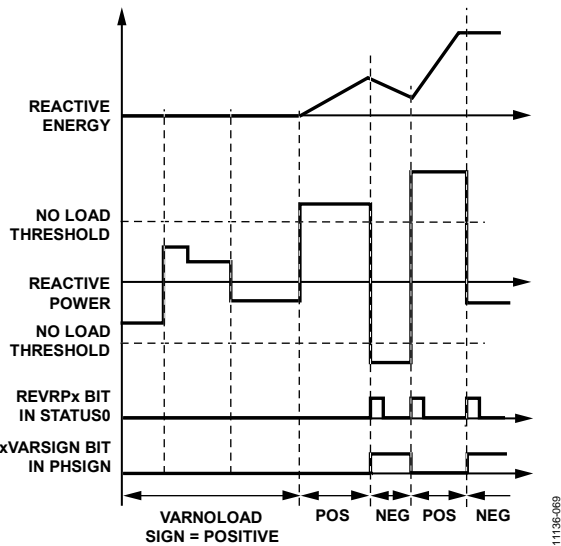

Figure 83. Reactive Power Signed Accumulation Mode

When VARACC[1:0] = 10, the reactive powers are accumulated depending on the sign of the corresponding active power. If the active power is positive, the reactive power is accumulated as it is (without any changes). If the active power is negative, the sign of the reactive power is changed for accumulation. Figure 84 shows how the sign adjusted reactive power accumulation mode functions. In this mode, the xVARHR registers continue to accumulate reactive powers in signed mode, even if the CFx pulses are generated based on the sign adjusted accumulation mode.

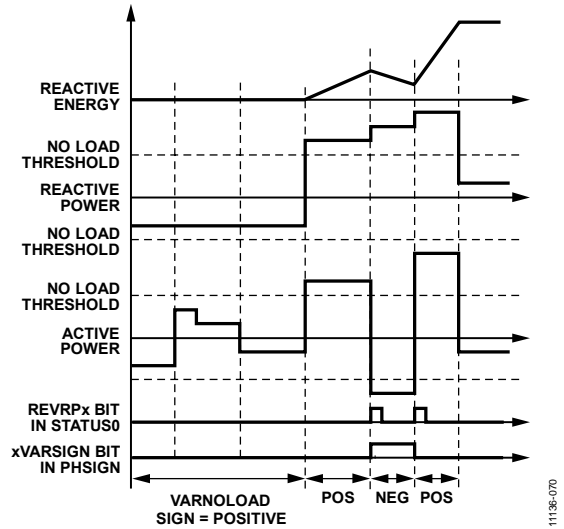

Figure 84. Reactive Power Accumulation in Sign Adjusted Mode

When VARACC[1:0] = 11, the reactive powers are accumulated in an absolute mode. When the powers are negative, they change sign and accumulate together with the positive power. Figure 85 shows how the absolute accumulation mode of reactive power functions. In this mode, the xVARHR registers continue to accumulate reactive powers in signed mode, even when the CFx pulses are generated based on the absolute accumulation mode.

The VARACC[1:0] setting of 01 is reserved. If set to 01, the ADE7854A/ADE7858A/ADE7868A/ADE7878A behave identically to VARACC[1:0] = 00.

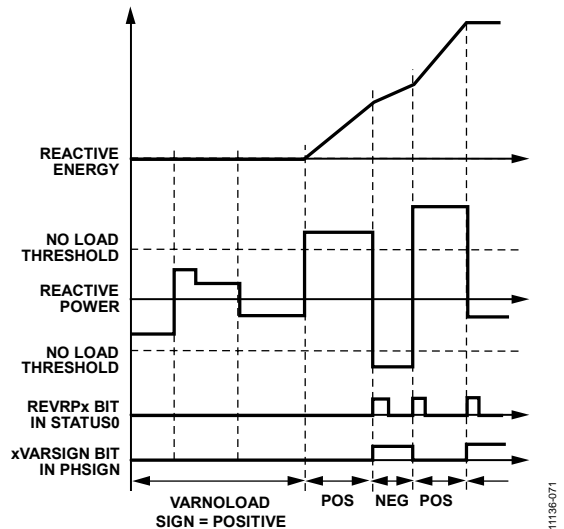

Figure 85. Reactive Power Absolute Accumulation Mode

Sign of Sum-of-Phase Powers in the CFx Datapath

The ADE7854A/ADE7858A/ADE7868A/ADE7878A have sign detection circuitry for the sum of phase powers that are used in the CFx datapath. The energy accumulation in the CFx datapath is executed in two stages (see the Energy to Frequency Conversion section). Every time a sign change is detected in the energy accumulation at the end of the first stage, that is, after the energy accumulated into the accumulator reaches one of the

WTHR, VARTHR, or VATHR thresholds, a dedicated interrupt can be triggered synchronously with the corresponding CFx pulse. The sign of each sum can be read in the PHSIGN register.

Bit 18, Bit 13, and Bit 9 (REVPSUM3, REVPSUM2, and REVPSUM1, respectively) of the STATUS0 register are set to 1 when a sign change of the sum of powers in CF3, CF2, or CF1 datapaths occurs. To correlate these events with the pulses generated at the CFx pins, after a sign change occurs, Bit REVPSUM3, Bit REVPSUM2, and Bit REVPSUM1 are set in the same moment in which a high to low transition at the CF3/HSCCLK, CF2, and CF1 pin, respectively, occurs.

Bit 8, Bit 7, and Bit 3 (SUM3SIGN, SUM2SIGN, and SUM1SIGN, respectively) of the PHSIGN register are set in the same moment with Bit REVPSUM3, Bit REVPSUM2, and Bit REVPSUM1 and indicate the sign of the sum of phase powers. When cleared to 0, the sum is positive. When set to 1, the sum is negative.

Interrupts attached to Bit 18, Bit 13, and Bit 9 (REVPSUM3, REVPSUM2, and REVPSUM1, respectively) in the STATUS0 register are enabled by setting Bit 18, Bit 13, and Bit 9 in the MASK0 register to 1. When enabled, the IRQ0 pin is set low, and the status bit is set to 1 whenever a change of sign occurs. To find the phase that triggered the interrupt, the PHSIGN register is read immediately after reading the STATUS0 register. Next, writing to the STATUS0 register with the corresponding bit set to 1 clears the status bit and resets the IRQ0 pin to high.

NO LOAD CONDITION

The no load condition is defined in metering equipment standards as occurring when the voltage is applied to the meter and no current flows in the current circuit. To eliminate any creep effects in the meter, the ADE7854A/ADE7858A/ADE7868A/ADE7878A contain three separate no load detection circuits: one related to the total active and reactive powers (ADE7858A/ADE7868A/ADE7878A only), one related to the fundamental active and reactive powers (ADE7878A only), and one related to the apparent powers (all devices).

No Load Detection Based on Total Active and Reactive Powers

This no load condition is triggered when the absolute values of both phase total active and reactive powers are less than or equal to positive thresholds indicated in the respective APNOLOAD and VARNLOAD signed 24-bit registers. In this case, the total active and reactive energies of that phase are not accumulated, and no CFx pulses are generated based on these energies. The APNOLOAD register represents the positive no load level of active power relative to PMAX, the maximum active power obtained when full-scale voltages and currents are provided at ADC inputs. The VARNLOAD register represents the positive no load level of reactive power relative to PMAX. The expression used to compute the APNOLOAD signed 24-bit value is

$$APNOLOAD = \frac{V_n}{V_{FS}} \times \frac{I_{NLOAD}}{I_{FS}} \times PMAX \tag{57}$$

where:

V_n is the nominal rms value of phase voltage.

V_{FS} , I_{FS} are the rms values of phase voltages and currents when the ADC inputs are at full scale.

I_{NLOAD} is the minimum rms value of phase current the meter starts measuring.

$PMAX = 33,516,139 = 0x1FF6A6B$, which is the instantaneous power computed when the ADC inputs are at full scale.

The VARNLOAD register usually contains the same value as the APNOLOAD register. When APNOLOAD and VARNLOAD are set to negative values, the no load detection circuit is disabled.

Note that the ADE7854A measures only the total active powers. To ensure good functionality of the ADE7854A no load circuit, set the VARNLOAD register at 0x800000.

As previously stated in the Current Waveform Gain Registers section, the serial ports of the device work on 32-, 16-, or 8-bit words and the DSP works on 28 bits. APNOLOAD and VARNLOAD 24-bit signed registers are accessed as 32-bit registers with the four MSBs padded with 0s and sign extended to 28 bits (see Figure 34).

Bit 0 (NLOAD) in the STATUS1 register is set when this no load condition in one of the three phases is triggered. Bits[2:0] (NLPHASE[2:0]) in the PHNOLOAD register indicate the state of all phases relative to a no load condition and are set simultaneously with Bit NLOAD in the STATUS1 register.

- NLPHASE[0] indicates the state of Phase A.
- NLPHASE[1] indicates the state of Phase B.
- NLPHASE[2] indicates the state of Phase C.

When Bit NLPHASE[x] is cleared to 0, it means that the phase is out of a no load condition. When set to 1, it means that the phase is in a no load condition.

Setting Bit 0 in the MASK1 register to 1 enables an interrupt attached to Bit 0 (NLOAD) in the STATUS1 register. When enabled, the IRQ1 pin is set to low, and the status bit is set to 1 whenever one of three phases enters or exits this no load condition. To find the phase that triggered the interrupt, the PHNOLOAD register is read immediately after reading the STATUS1 register. Next, writing to the STATUS1 register with the corresponding bit set to 1 clears the status bit and sets the IRQ1 pin to high.

No Load Detection Based on Fundamental Active and Reactive Powers—ADE7878A Only

This no load condition (available on the ADE7878A only) is triggered when the absolute values of both phase fundamental active and reactive powers are less than or equal to the respective APNOLOAD and VARNLOAD positive thresholds. In this case, the fundamental active and reactive energies of that phase are not accumulated, and no CFx pulses are generated based on these energies. APNOLOAD and VARNLOAD are the same

no load thresholds set for the total active and reactive powers. When APNOLOAD and VARNLOAD are set to negative values, this no load detection circuit is disabled.

Bit 1 (FNLOAD) in the STATUS1 register is set when this no load condition in one of the three phases is triggered. Bits[5:3] (FNLPHASE[2:0]) in the PHNOLOAD register indicate the state of all phases relative to a no load condition and are set simultaneously with Bit FNLOAD in the STATUS1 register. FNLPHASE[0] indicates the state of Phase A, FNLPHASE[1] indicates the state of Phase B, and FNLPHASE[2] indicates the state of Phase C. When Bit FNLPHASE[x] is cleared to 0, it means the phase is out of the no load condition. When set to 1, it means the phase is in a no load condition.

Setting Bit 1 in the MASK1 register enables an interrupt attached to the Bit 1 (FNLOAD) in the STATUS1 register. When enabled, the $\overline{\text{IRQ1}}$ pin is set low and the status bit is set to 1 whenever one of three phases enters or exits this no load condition. To find the phase that triggered the interrupt, the PHNOLOAD register is read immediately after reading the STATUS1 register. Next, writing to the STATUS1 register with the corresponding bit set to 1 clears the status bit and resets the $\overline{\text{IRQ1}}$ pin to high.

No Load Detection Based on Apparent Power

This no load condition is triggered when the absolute value of phase apparent power is less than or equal to the threshold indicated in the VANLOAD 24-bit signed register. In this case, the apparent energy of that phase is not accumulated and no CFx pulses are generated based on this energy. The VANLOAD register represents the positive no load level of apparent power relative to PMAX, the maximum apparent power obtained when full-scale voltages and currents are provided at the ADC inputs. The expression used to compute the VANLOAD signed 24-bit value is

$$\text{VANLOAD} = \frac{V_n}{V_{FS}} \times \frac{I_{\text{NOLOAD}}}{I_{FS}} \times \text{PMAX} \quad (58)$$

where:

V_n is the nominal rms value of phase voltage.

V_{FS} , I_{FS} are the rms values of phase voltages and currents when the ADC inputs are at full scale.

I_{NOLOAD} is the minimum rms value of phase current the meter starts measuring.

$\text{PMAX} = 33,516,139 = 0x1FF6A6B$, which is the instantaneous apparent power computed when the ADC inputs are at full scale.

Setting the VANLOAD register to negative values disables the no load detection circuit.

As stated in the Current Waveform Gain Registers section, the serial ports of the [ADE7854A/ADE7858A/ADE7868A/ADE7878A](#) work on 32-, 16-, or 8-bit words and the DSP works on 28 bits. Similar to the registers presented in Figure 34, the VANLOAD 24-bit signed register is accessed as a 32-bit register with the four MSBs padded with 0s and sign extended to 28 bits.

Bit 2 (VANLOAD) in the STATUS1 register is set when this no load condition in one of the three phases is triggered. Bits[8:6] (VANLPHASE[2:0]) in the PHNOLOAD register indicate the state of all phases relative to a no load condition, and they are set simultaneously with Bit VANLOAD in the STATUS1 register:

- Bit VANLPHASE[0] indicates the state of Phase A.
- Bit VANLPHASE[1] indicates the state of Phase B.
- Bit VANLPHASE[2] indicates the state of Phase C.

When Bit VANLPHASE[x] is cleared to 0, it means that the phase is out of no load condition. When set to 1, it means that the phase is in no load condition.

An interrupt attached to Bit 2 (VANLOAD) in the STATUS1 register is enabled by setting Bit 2 in the MASK1 register. If enabled, the $\overline{\text{IRQ1}}$ pin is set low and the status bit is set to 1 when one of three phases enters or exits this no load condition. To find the phase that triggered the interrupt, the PHNOLOAD register is read immediately after reading the STATUS1 register. Next, writing to the STATUS1 register with the corresponding bit set to 1 clears the status bit and sets the $\overline{\text{IRQ1}}$ pin to high.

CHECKSUM REGISTER

The [ADE7854A/ADE7858A/ADE7868A/ADE7878A](#) have a 32-bit checksum register, checksum, that ensures that certain very important configuration registers maintain their desired value during normal power mode, PSM0.

The registers covered by this checksum register are MASK0, MASK1, COMPMODE, gain, CFMODE, CF1DEN, CF2DEN, CF3DEN, CONFIG, APHCAL, BPHCAL, CPHCAL, a 16-bit internal register, MMODE, ACCMODE, LCYCMODE, HSDC_CFG, CONFIG_A, six 8-bit reserved internal registers that always have default values, and all DSP data memory RAM registers from the Address 0x4380 to Address 0x43BE. The device computes the cyclic redundancy check (CRC) based on the IEEE 802.3 standard. The registers are introduced one by one into a linear feedback shift register (LFSR) generator starting with the least significant bit (see Figure 86). The 32-bit result is written in the checksum register. After power-up or a hardware/software reset, the CRC is computed on the default values of the registers, giving the results listed in Table 23.

Table 23. Default Values of Checksum Register and CRC of Internal Registers

Part No.	Default Value of Checksum	CRC of Internal Registers
ADE7854A	0x6A9775D9	0x391FBDDD
ADE7858A	0xE908F4D0	0x3E7D0FC1
ADE7868A	0xEEF4CB9A	0x23F7C7B1
ADE7878A	0XED0AD43F	0x2D32A389

Figure 87 shows how the LFSR functions. The MASK0, MASK1, COMPMODE, gain, CFMODE, CF1DEN, CF2DEN, CF3DEN, CONFIG, APHCAL, BPHCAL, CPHCAL, a 16-bit internal register, MMODE, ACCMODE, LCYCMODE, and HSDC_CFG and CONFIG_A registers, the six 8-bit reserved internal registers,

and all DSP data memory RAM registers from Address Location 0x4380 to Address Location 0x43BE form the [a₂₃₄₃, a₂₃₄₂, ..., a₀] bits used by the LFSR. Bit a₀ is the least significant bit of the first internal register to enter the LFSR; Bit a₂₅₅ is the most significant bit of the MASK0 register, the last register to enter the LFSR. The formulae that govern LFSR are as follows:

b_i(0) = 1, i = 0, 1, 2, ..., 31, the initial state of the bits that form the CRC. Bit b₀ is the least significant bit, and Bit b₃₁ is the most significant.

g_i, i = 0, 1, 2, ..., 31 are the coefficients of the generating polynomial defined by the IEEE802.3 standard as follows:

$$G(x) = x^{32} + x^{26} + x^{23} + x^{22} + x^{16} + x^{12} + x^{11} + x^{10} + x^8 + x^7 + x^5 + x^4 + x^2 + x + 1 \tag{59}$$

$$\begin{aligned} g_0 = g_1 = g_2 = g_4 = g_5 = g_7 = 1 \\ g_8 = g_{10} = g_{11} = g_{12} = g_{16} = g_{22} = g_{23} = g_{26} = 1 \end{aligned} \tag{60}$$

All of the other g_i coefficients are equal to 0.

$$FB(j) = a_{j-1} \text{ XOR } b_{31}(j-1) \tag{61}$$

$$b_0(j) = FB(j) \text{ AND } g_0 \tag{62}$$

$$b_i(j) = FB(j) \text{ AND } g_i \text{ XOR } b_{i-1}(j-1), i = 1, 2, 3, \dots, 31 \tag{63}$$

Equation 61, Equation 62, and Equation 63 must be repeated for j = 1, 2, ..., 2344. The value written into the checksum register contains Bit b_i(2344), i = 0, 1, ..., 31. The value of the CRC, after the bits from the reserved internal register have passed through the LFSR, is obtained at Step j = 48 and is listed in Table 23.

Two different approaches can be followed in using the checksum register. One is to compute the CRC based on the relations (Equation 59 to Equation 63) and then compare the value against the CHECKSUM register. Another is to periodically read the CHECKSUM register. If two consecutive readings differ, it can be assumed that one of the registers has changed value and, therefore, the ADE7854A, ADE7858A, ADE7868A, or ADE7878A has changed configuration. A CRC interrupt is made available for this purpose. The corresponding status bit (Bit 25 of the STATUS1 register) is set when the value of the checksum register changes. The recommended response is to initiate a hardware/software reset that sets the values of all registers to the default, including the reserved ones, and then reinitializes the configuration registers.

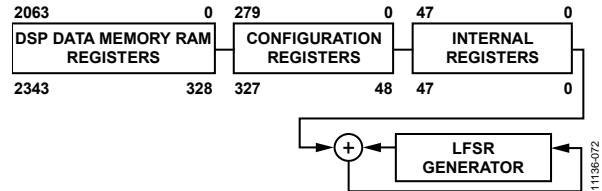

Figure 86. Checksum Register Calculation

INTERRUPTS

The ADE7854A/ADE7858A/ADE7868A/ADE7878A have two interrupt pins, IRQ0 and IRQ1; each of these pins is managed by a 32-bit interrupt mask register, MASK0 and MASK1, respectively. To enable an interrupt, a bit in the MASKx register must be set to 1. To disable it, the bit must be cleared to 0. Two 32-bit status registers, STATUS0 and STATUS1, are associated with the interrupts.

When an interrupt event occurs in the ADE7854A/ADE7858A/ADE7868A/ADE7878A, the corresponding flag in the interrupt status register is set to Logic 1 (see Table 34 and Table 35). If the mask bit for this interrupt in the interrupt mask register is Logic 1, the IRQx logic output goes active low. The flag bits in the interrupt status register are set irrespective of the state of the mask bits. To determine the source of the interrupt, the microcontroller unit (MCU) performs a read of the corresponding STATUSx register and identifies which bit is set to 1.

To erase the flag in the status register, write back to the STATUSx register with the flag set to 1. After an interrupt pin goes low, the status register is read and the source of the interrupt is identified. Then, the status register is written back without any change to clear the status flag to 0. The IRQx pin remains low until the status flag is cancelled.

By default, all interrupts are disabled. However, the RSTDONE interrupt is an exception. This interrupt can never be masked (disabled) and, therefore, Bit 15 (RSTDONE) in the MASK1 register does not have any functionality. The IRQ1 pin always goes low, and Bit 15 (RSTDONE) in the STATUS1 register is set to 1 whenever a power-up or a hardware/software reset process ends. To cancel the status flag, the STATUS1 register must be written with Bit 15 (RSTDONE) set to 1.

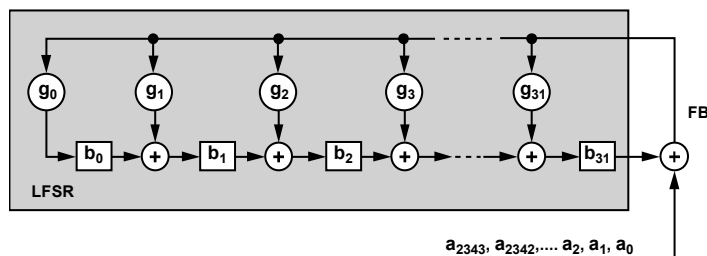

Figure 87. LFSR Generator Used in Checksum Register Calculation

Certain interrupts are used in conjunction with other status registers. The following bits in the MASK1 register work in conjunction with the status bits in the PHNOLOAD register:

- Bit 0 (NLOAD)
- Bit 1 (FNLOAD), available in the ADE7878A only
- Bit 2 (VANLOAD)

The following bits in the MASK1 register work with the status bits in the PHSTATUS register:

- Bit 16 (sag)
- Bit 17 (OI)
- Bit 18 (OV)

The following bits in the MASK1 register work with the status bits in the IPEAK and VPEAK registers, respectively:

- Bit 23 (PKI)
- Bit 24 (PKV)

The following bits in the MASK0 register work with the status bits in the PHSIGN register:

- Bits[6:8] (REVPx)
- Bits[10:12] (REVRPx), available in the ADE7858A, ADE7868A, and ADE7878A only
- Bit 9, Bit 13, and Bit 18 (REVPSUMx)

When the STATUSx register is read and one of these bits is set to 1, the status register associated with the bit is immediately read to identify the phase that triggered the interrupt; only at that time can the STATUSx register be written back with the bit set to 1.

Using the Interrupts with an MCU

Figure 88 shows a timing diagram of a suggested implementation of the ADE7854A/ADE7858A/ADE7868A/ADE7878A interrupt management using an MCU. At Time t₁, the IRQx pin goes active low, indicating that one or more interrupt events have

occurred in the device, at which point the following steps are required:

1. Tie the $\overline{\text{IRQx}}$ pin to a negative-edge-triggered external interrupt on the MCU.
2. On detection of the negative edge, configure the MCU to start executing its interrupt service routine (ISR).
3. On entering the ISR, disable all interrupts using the global interrupt mask bit. At this point, clear the MCU external interrupt flag to capture interrupt events that occur during the current ISR.
4. When the MCU interrupt flag is cleared, a read from STATUSx (the interrupt status register) is performed. The interrupt status register content determines the source of the interrupt(s) and, therefore, determines the appropriate action to be taken.
5. The same STATUSx content is written back into the device to clear the status flag(s) and reset the $\overline{\text{IRQx}}$ line to logic high (t₂).

If a subsequent interrupt event occurs during the ISR (t₃), that event is recorded by the MCU external interrupt flag being set again.

On returning from the ISR, the global interrupt mask bit is cleared, maintaining this same instruction cycle, and the external interrupt flag uses the MCU to jump to its ISR once again. This ensures that the MCU does not miss any external interrupts.

Figure 89 shows a recommended timing diagram when the status bits in the STATUSx registers work in conjunction with bits in other registers. Note that PHx in Figure 89 denotes one of the PHSTATUS, IPEAK, VPEAK, or PHSIGN registers.

When the $\overline{\text{IRQx}}$ pin goes active low, the STATUSx register is read. If one of these bits is set to 1, a second status register is read immediately to identify the phase that triggered the interrupt. Next, the STATUSx register is written back with the corresponding bit(s) set to 1, which clears the status flags.

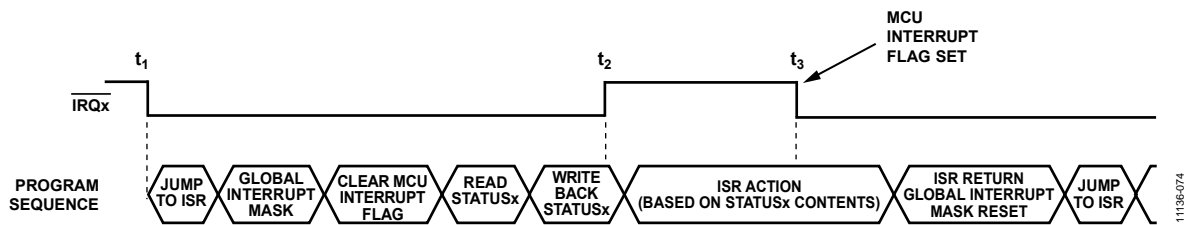

Figure 88. Interrupt Management

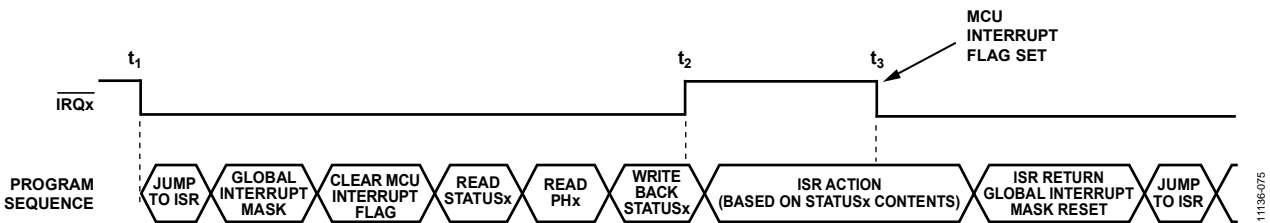

Figure 89. Interrupt Management with PHSTATUS, IPEAK, VPEAK, or PHSIGN Register

APPLICATIONS INFORMATION

Note that dual function pin names are referenced by the relevant function only, for example, CF3 for the calibration frequency output function of the CF3/HSCLK pin (see the Pin Configuration and Function Descriptions section for full pin mnemonics and descriptions).

QUICK SETUP OF DEVICES AS ENERGY METERS

An energy meter is usually characterized by the nominal current (I_n), nominal voltage (V_n), nominal frequency (f_n), and the meter constant (MC).

To quickly set up the [ADE7854A/ADE7858A/ADE7868A/ADE7878A](#), execute the following steps:

1. Select the PGA gains in the phase currents, voltages, and neutral current channels: Bits[2:0] (PGA1[2:0]), Bits[5:3] (PGA2[2:0]) and Bits[8:6] (PGA3[2:0]) in the gain register.
2. If Rogowski coils are used, enable the digital integrators in the phase and neutral currents: Bit 0 (INTEN) set to 1 in the CONFIG register.
3. If $f_n = 60$ Hz, set Bit 14 (SELFREQ) in the COMPMODE register ([ADE7878A](#) only) to 1.
4. Initialize WTHR1 and WTHR0 registers based on Equation 31. Make VARTH1 ([ADE7858A](#), [ADE7868A](#), and [ADE7878A](#) only) and VATHR1 equal to WTHR1 and VARTH0 ([ADE7858A](#), [ADE7868A](#), and [ADE7878A](#) only) and VATHR0 equal to WTHR0.
5. Initialize CF1DEN, CF2DEN, and CF3DEN based on Equation 56.
6. Initialize VLEVEL ([ADE7878A](#) only) and VNOM registers based on Equation 27 and Equation 51.
7. Enable the data memory RAM protection by writing 0xAD to an internal 8-bit register located at Address 0xE7FE followed by a write of 0x80 to an internal 8-bit register located at Address 0xE7E3.
8. Start the DSP by setting run = 1.
9. Read the energy registers xWATTHR, xVARHR ([ADE7858A](#), [ADE7868A](#), and [ADE7878A](#) only), xVAHR, xFWATTHR, and xFVARHR ([ADE7878A](#) only) to erase their contents and start energy accumulation from a known state.
10. Enable the CF1, CF2 and CF3 frequency converter outputs by clearing Bit 9 (CF1DIS), Bit 10 (CF2DIS), and Bit 11 (CF3DIS) to 0 in CFMODE register.

CRYSTAL CIRCUIT

A digital clock signal of 16.384 MHz can be provided at the CLKIN pin of the [ADE7854A/ADE7858A/ADE7868A/ADE7878A](#). Alternatively, attach a crystal of the specified frequency, as shown in Figure 90. CL_1 and CL_2 denote the capacitances of the ceramic capacitors attached to the crystal pins, whereas CP_1 and CP_2 denote the parasitic capacitances on those pins.

The recommended typical value of total capacitance at each clock pin, CLKIN and CLKOUT, is 36 pF, which means that

$$Total\ Capacitance = CP_1 + CL_1 = CP_2 + CL_2 = 36\ pF$$

Crystal manufacturer data sheets specify the load capacitance value. A total capacitance of 36 pF, per clock pin, is recommended; therefore, select a crystal with a 18 pF load capacitance. In addition, when selecting the ceramic capacitors, CL_1 and CL_2 , the parasitic capacitances, CP_1 and CP_2 , on the crystal pins of the IC must be taken into account. Thus, the values of CL_1 and CL_2 must be based on the following expression:

$$CL_1 = CL_2 = 2 \times Crystal\ Load\ Capacitance - CP_1$$

where $CP_1 = CP_2$.

For example, if a 18 pF crystal is chosen and the parasitic capacitances on the clock pins are $CP_1 = CP_2 = 2$ pF, the ceramic capacitors that must be used in the crystal circuit are $CL_1 = CL_2 = 34$ pF.

The [EVAL-ADE7878AEBZ](#) evaluation board uses the crystal ECS-163.8-18-4XEN. It is recommended that the same crystal, or a crystal with similar specifications, be selected. Lower values of ESR and load capacitance and higher values of drive level capability of the crystal are preferable.

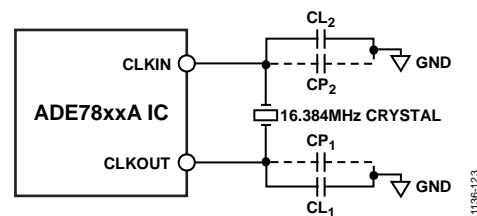

Figure 90. Crystal Circuit

LAYOUT GUIDELINES

Figure 91 shows a basic schematic of the ADE7878A together with its surrounding circuitry: decoupling capacitors at the VDD, AVDD, DVDD, and REF_{IN/OUT} pins as well as the 16.384 MHz crystal and its load capacitors. The remaining pins are dependent on the specific application and are not shown in Figure 91. The ADE7854A, ADE7858A, and ADE7868A use an identical approach to their decoupling capacitors, crystal, and load capacitors.

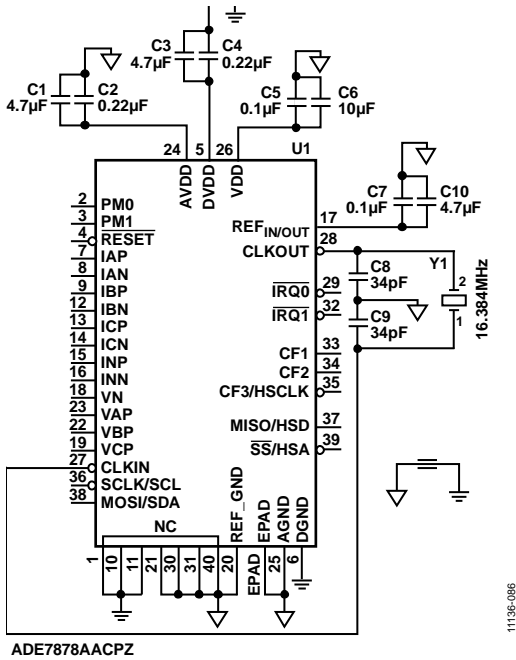

Figure 91. ADE7878A Crystal and Capacitor Connections

Figure 92 and Figure 93 illustrate a proposed layout of a PCB with two layers; in this layout, the components are placed on the top layer of the PCB only.

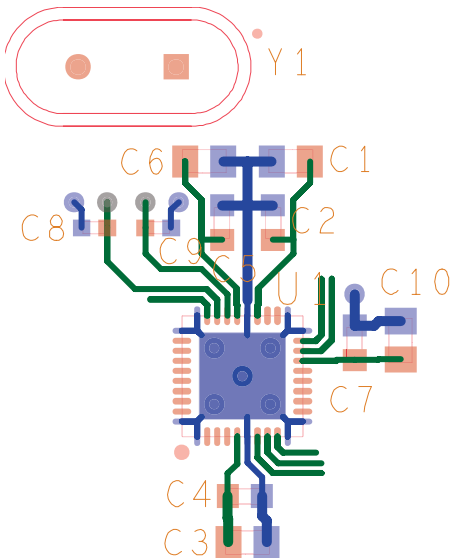

Figure 92. ADE7878A PCB, Top Layer

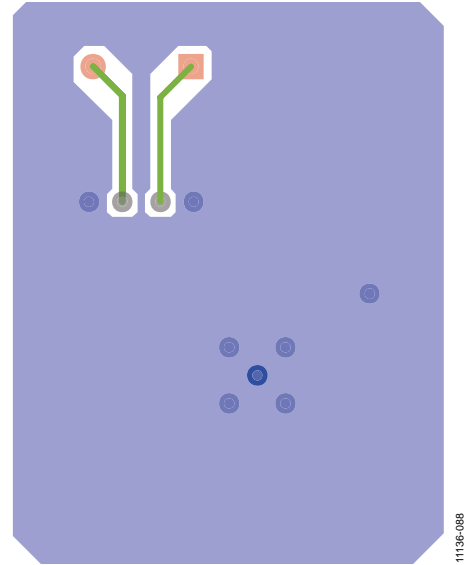

Figure 93. ADE7878A PCB, Bottom Layer

Each of the VDD, AVDD, DVDD, and REF_{IN/OUT} pins have two decoupling capacitors: one capacitor must be of the microfarad order and the other must be a ceramic capacitor of 220 nF or 100 nF. The ceramic capacitor must be placed closest to the pins of the ADE7878A to decouple high frequency noises; place the microfarad capacitor in close proximity to the device.

The crystal can be placed close to the device, but it is important that the crystal load capacitors be placed closer to the device than the crystal.

Solder the exposed pad of the ADE7878A to an equivalent pad on the PCB. Then route the AGND and DGND traces of the ADE7878A directly into the PCB pad.

The bottom layer is composed mainly of a ground plane that surrounds the crystal traces as much as possible.

ADE7878A EVALUATION BOARD

An evaluation board built upon the ADE7878A configuration supports the evaluation of all features for the ADE7854A, ADE7858A, ADE7868A, and ADE7878A devices. For more information about the evaluation board, visit www.analog.com.

DIE VERSION

The version register identifies the version of the die. This 8-bit, read only register is located at Address 0xE707.

SILICON ANOMALY

This anomaly list describes the known issues with the [ADE7854A](#), [ADE7858A](#), [ADE7868A](#), and [ADE7878A](#) silicon identified by the version register (Address 0xE707) being equal to 2.

Analog Devices, Inc., is committed, through future silicon revisions, to continuously improve silicon functionality. Analog Devices tries to ensure that these future silicon revisions remain compatible with your present software/systems by implementing the recommended workarounds outlined here.

[ADE7854A/ADE7858A/ADE7868A/ADE7878A](#) FUNCTIONALITY ISSUES

Silicon Revision Identifier	Chip Marking	Silicon Status	Anomaly Sheet	No. of Reported Issues
Version = 2	ADE7854ACPZ ADE7858ACPZ ADE7868ACPZ ADE7878ACPZ	Released	Rev. B	1 (er001)

FUNCTIONALITY ISSUES

Table 24. LAST_ADDR and LAST_RWDATA_x Register Shows Wrong Value in Burst SPI Mode [er001, Version = 2 Silicon]

Background	When any ADE7854A/ADE7858A/ADE7868A/ADE7878A register is read using SPI or I ² C communication, the address is stored in the LAST_ADDR register and the data is stored in the respective LAST_RWDATA_x register.
Issue	When the waveform registers located between Address 0xE50C and Address 0xE51B are read using burst SPI mode, the LAST_ADDR register contains the address of the register incremented by 1 and the LAST_RWDATA_x register contains the data corresponding to the faulty address in the LAST_ADDR register. The issue is not present if the I ² C communication is used.
Workaround	After accessing the waveform registers in burst SPI mode, perform another read/write operation elsewhere before using the communication verification registers.
Related Issues	None.

Section 1. [ADE7854A/ADE7858A/ADE7868A/ADE7878A](#) Functionality Issues

Reference Number	Description	Status
er001	LAST_ADDR and LAST_RWDATA_x register shows wrong value in burst SPI mode.	Identified

This completes the Silicon Anomaly section.

SERIAL INTERFACES

The [ADE7854A/ADE7858A/ADE7868A/ADE7878A](#) have three serial port interfaces: one I²C interface, one serial peripheral interface (SPI), and one high speed data capture (HSDC) port. Because the SPI pins are multiplexed with pins for the I²C and HSDC ports, the device accepts two configurations: one using the SPI port only and one using the I²C port in conjunction with the HSDC port.

Note that within this section and diagrams, dual function pin names are referenced by the relevant function only (see the Pin Configuration and Function Descriptions section for full pin mnemonics and descriptions).

SERIAL INTERFACE SELECTION

After a reset of the [ADE7854A/ADE7858A/ADE7868A/ADE7878A](#), the HSDC port is always disabled. After power-up or after a hardware reset, select the I²C or SPI port by manipulating the \overline{SS} /HSA pin (Pin 39).

- If the \overline{SS} /HSA pin is pulled high, the [ADE7854A/ADE7858A/ADE7868A/ADE7878A](#) use the I²C port until another hardware reset is executed.
- If the \overline{SS} /HSA pin is toggled high to low three times, the [ADE7854A/ADE7858A/ADE7868A/ADE7878A](#) use the SPI port until another hardware reset is executed.

The manipulation of the \overline{SS} /HSA pin can be accomplished in two ways.

- Use the \overline{SS} pin of the master device (that is, the microcontroller) as a regular I/O pin and toggle it three times.
- Execute three SPI write operations to a location in the address space that is not allocated to a specific [ADE7854A/ADE7858A/ADE7868A/ADE7878A](#) register (for example, Address 0xEBFF, where writes to 8-bit registers can be executed). These writes cause the \overline{SS} /HSA pin to toggle three times. For more information about the write protocol involved, see the SPI Write Operation section.

After the serial port selection is completed, the serial port selection must be locked. In this way, the active port remains in use until a hardware reset is executed in PSM0 normal mode or until a power-down occurs. If I²C is the active serial port, Bit 1 (I2C_LOCK) of the CONFIG2 register must be set to 1 to lock it. After the write to this bit is done, the [ADE7854A/ADE7858A/ADE7868A/ADE7878A](#) ignore spurious toggling of the \overline{SS} /HSA pin, and a switch to the SPI port is no longer possible. If the active serial port is the SPI, any write to the CONFIG2 register locks the port. After this write, a switch to the I²C port is no longer possible.

After the serial port selection is locked, the serial port selection is maintained when the device changes PSMx power mode.

The functionality of the device is accessible via several on-chip registers. Update or read the contents of these registers using either the I²C or SPI interface. The HSDC port provides the

state of up to 16 registers representing instantaneous values of phase voltages and neutral currents, as well as active, reactive, and apparent powers.

COMMUNICATION VERIFICATION

The [ADE7854A/ADE7858A/ADE7868A/ADE7878A](#) include a set of three registers that allow any communication via I²C or SPI to be verified. The LAST_OP (Address 0xE7FD), LAST_ADDR (Address 0xE6FE), and LAST_RWDATA_x registers record the nature, address, and data of the last successful communication, respectively. The LAST_RWDATA_x registers, each with a separate address, depending on the length of the successful communication (see Table 25).

Table 25. LAST_RWDATA_x Register Locations

Communication Type	Address
8-Bit Read/Write	0xE7FC
16-Bit Read/Write	0xE6FF
32-Bit Read/Write	0xE5FF

After each successful communication with the [ADE7854A/ADE7858A/ADE7868A/ADE7878A](#), the address of the register that was last accessed is stored in the 16-bit LAST_ADDR register (Address 0xE6FE). This read-only register stores the value until the next successful read or write is completed.

The LAST_OP register (Address 0xE7FD) stores the nature of the operation; that is, it indicates whether a read or a write was performed. If the last operation was a write, the LAST_OP register stores the value 0xCA. If the last operation was a read, the LAST_OP register stores the value 0x35. The LAST_RWDATA_x register stores the data that was written to or read from the register. Any unsuccessful read or write operation is not reflected in these registers.

When the LAST_OP, LAST_ADDR, and LAST_RWDATA_x registers are read, their values remain unchanged.

I²C-COMPATIBLE INTERFACE

The [ADE7854A/ADE7858A/ADE7868A/ADE7878A](#) support a I²C interface. The I²C interface is implemented as a full hardware slave. The maximum serial clock frequency supported by the I²C interface is 400 kHz.

SDA is the data I/O, and SCL is the serial clock. These two functions are multiplexed with the MOSI and SCLK functions of the on-chip SPI interface as MOSI/SDA and SCL/SCLK. The SDA and SCL pins are configured in a wire-AND format that allows arbitration in a multimaster system.

The transfer sequence of an I²C system consists of a master device initiating a transfer by generating a start condition while the bus is idle. The master transmits the address of the slave device and the direction of the data transfer in the initial address transfer. If the slave acknowledges the master, the data transfer is initiated. Data transfer continues until the master issues a stop condition, and the bus becomes idle.

I²C Write Operation

A write operation using the I²C interface of the ADE7854A/ADE7858A/ADE7868A/ADE7878A is initiated when the master generates a start condition, which consists of one byte representing the slave address of the device followed by the 16-bit address of the target register and the value of that register (see Figure 94). The addresses and the register contents are sent with the most significant bit first.

The most significant seven bits of the address byte contain the address of the ADE7854A, ADE7858A, ADE7868A, or ADE7878A, which is equal to 0111000. Bit 0 of the address byte is the read/write bit. For a write operation, Bit 0 must be cleared to 0; therefore, the first byte of the write operation is 0x70. After each byte is received, the device (ADE7854A, ADE7858A, ADE7868A, or ADE7878A) generates an acknowledge. Registers can have eight, 16, or 32 bits; after the last bit of the register is transmitted and the device acknowledges the transfer, the master generates a stop condition.

I²C Read Operation

A read operation using the I²C interface of the ADE7854A/ADE7858A/ADE7868A/ADE7878A is accomplished in two stages. The first stage sets the pointer to the address of the register. The second stage reads the contents of the register.

As shown in Figure 95, the first stage begins when the master generates a start condition, which consists of one byte representing the slave address of the ADE7854A/ADE7858A/ADE7868A/ADE7878A, followed by the 16-bit address of the target register. The device acknowledges each byte received. The address byte is similar to the address byte for a write operation and is equal to 0x70 (see the I²C Write Operation section).

After the last byte of the register address is sent and acknowledged by the ADE7854A/ADE7858A/ADE7868A/ADE7878A, the second stage begins with the master generating a new start condition followed by an address byte. The most significant seven bits of this address byte contain the address of the device, which is equal to 0111000. For a read operation, Bit 0 must be set to 1; therefore, the first byte of the read operation is 0x71. After this byte is received, the device generates an acknowledge. The device then sends the value of the register, and the master generates an acknowledge after each byte is received. All the bytes are sent MSB first. Registers can have 8, 16, or 32 bits; after the last bit of the register is received, the master does not acknowledge the transfer but, instead, generates a stop condition.

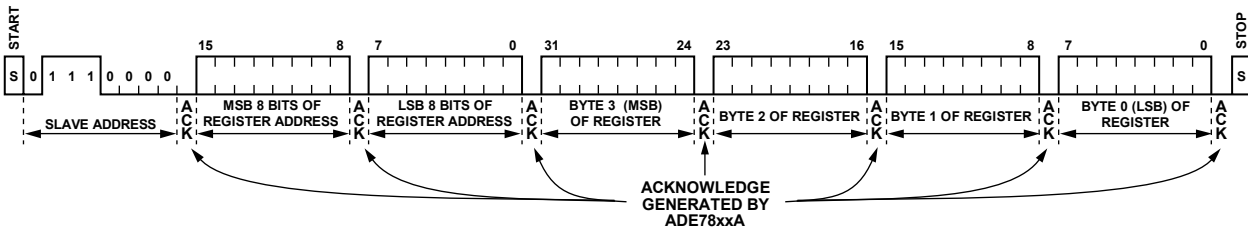

Figure 94. I²C Write Operation of a 32-Bit Register

11136-076

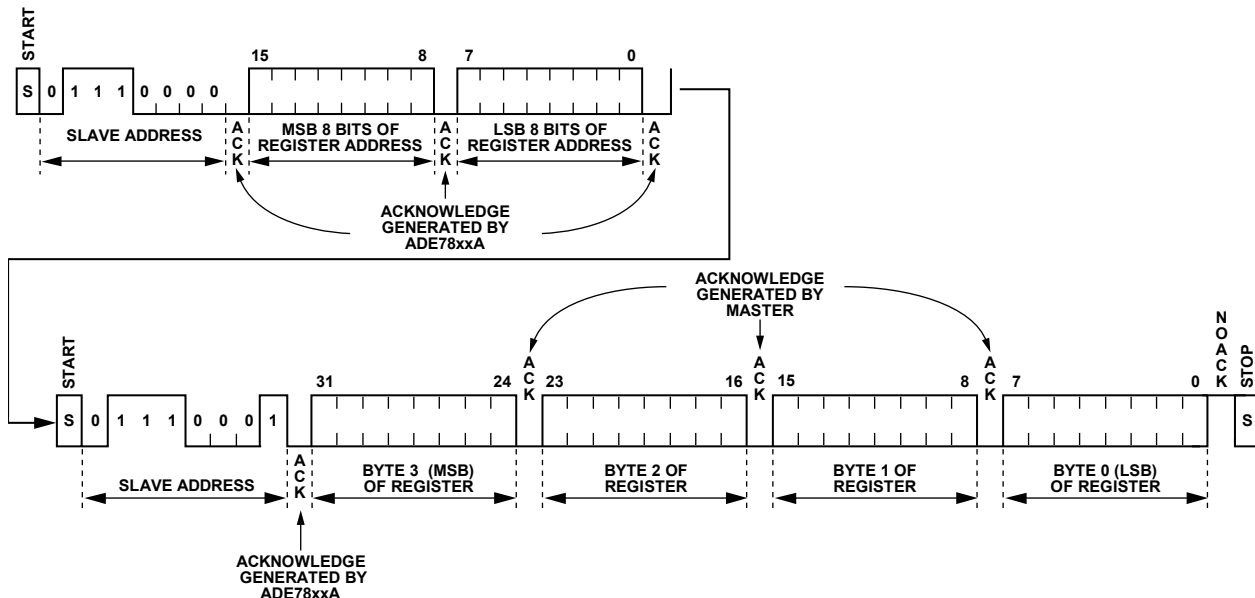

Figure 95. I²C Read Operation of a 32-Bit Register

11136-077

SPI-COMPATIBLE INTERFACE

The SPI of the [ADE7854A/ADE7858A/ADE7868A/ADE7878A](#) is always a slave in the communication and consists of four pins (with dual functions): SCLK/SCL, MOSI/SDA, MISO/HSD, and \overline{SS} /HSA. The functions used in the SPI-compatible interface are SCLK, MOSI, MISO, and \overline{SS} .

The serial clock for a data transfer is applied at the SCLK logic input. All data transfer operations synchronize to the serial clock. The maximum serial clock frequency supported by this interface is 2.5 MHz.

Data shifts into the device at the MOSI logic input on the falling edge of SCLK, and the device samples it on the rising edge of SCLK. Data shifts out of the [ADE7854A/ADE7858A/ADE7868A/ADE7878A](#) at the MISO logic output on the falling edge of SCLK and is sampled by the master device on the rising edge of SCLK. The most significant bit of the word is shifted in and out first. MISO stays in high impedance when no data is transmitted from the [ADE7854A/ADE7858A/ADE7868A/ADE7878A](#).

Figure 96 shows the connection between the [ADE7854A/ADE7858A/ADE7868A/ADE7878A](#) SPI and a master device that contains a SPI interface.

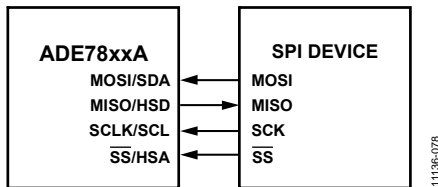

Figure 96. Connecting the ADE78xxA SPI to an SPI Device

The \overline{SS} logic input is the chip select input. This input is used when multiple devices share the serial bus. Drive the \overline{SS} input low for the entire data transfer operation. Bringing \overline{SS} high during a data transfer operation aborts the transfer and places the serial bus in a high impedance state. A new transfer can be initiated by returning the \overline{SS} logic input low. However, aborting a data transfer before completion leaves the accessed register in a state that cannot be guaranteed. Every time a register is written, verify its value by reading it back. The protocol is similar to the protocol used in the I²C interface.

SPI Write Operation

A write operation using the SPI interface of the [ADE7854A/ADE7858A/ADE7868A/ADE7878A](#) is initiated when the master

sets the \overline{SS} pin low and begins sending one byte, representing the slave address of the device, on the MOSI line (see Figure 97). The master sends data on the MOSI line starting with the first high to low transition of SCLK. The SPI of the [ADE7854A/ADE7858A/ADE7868A/ADE7878A](#) samples the data on the low to high transitions of SCLK.

The most significant seven bits of the address byte can have any value, but as a good programming practice, set these bits to a value other than 0111000, which is the 7-bit address used in the I²C protocol. Bit 0 of the address byte is the read/write bit. For a write operation, Bit 0 must be cleared to 0. The master then sends the 16-bit address of the register that is to be written followed by the 32-, 16-, or 8-bit value of that register without losing an SCLK cycle. After the last bit is transmitted, the master sets the \overline{SS} and SCLK lines high at the end of the SCLK cycle, and the communication ends. The data lines, MOSI and MISO, enter a high impedance state.

SPI Read Operation

A read operation using the SPI interface of the [ADE7854A/ADE7858A/ADE7868A/ADE7878A](#) is initiated when the master sets the \overline{SS} pin low and begins sending one byte, representing the address of the [ADE7854A, ADE7858A, ADE7868A, or ADE7878A](#), on the MOSI line (see Figure 95). The master sends data on the MOSI line starting with the first high to low transition of SCLK. The SPI of the [ADE7854A/ADE7858A/ADE7868A/ADE7878A](#) samples the data on the low to high transitions of SCLK.

The most significant seven bits of the address byte can have any value, but as a good programming practice, set these bits to a value other than 0111000, which is the 7-bit address used in the I²C protocol. Bit 0 of the address byte is the read/write bit. For a read operation, Bit 0 must be set to 1. The master then sends the 16-bit address of the register that is to be read. After the [ADE7854A/ADE7858A/ADE7868A/ADE7878A](#) receive the last bit of the register address on a low to high transition of SCLK, it begins to transmit the register contents on the MISO line when the next SCLK high to low transition occurs; the master samples the data on a low to high SCLK transition.

After the master receives the last bit, it sets the \overline{SS} and SCLK lines high, and the communication ends. The data lines, MOSI and MISO, enter a high impedance state.

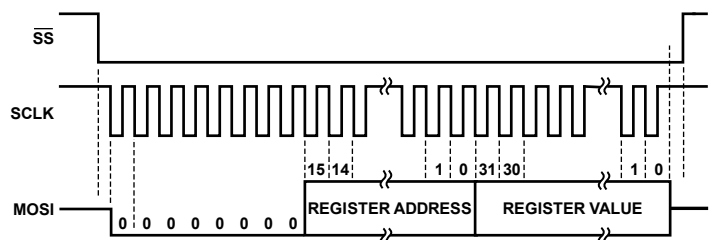

Figure 97. SPI Write Operation of a 32-Bit Register

SPI Burst Read Operation

The registers containing the instantaneous current and voltage, active power, reactive power, and apparent power can be read using the SPI burst mode. This mode allows multiple registers with successive addresses to be accessed with one command. The registers that can be accessed using the SPI burst mode are located at Address 0xE50C through Address 0xE51B. These registers are all 32 bits wide.

Burst mode is initiated when the master sets the \overline{SS} pin low and begins sending one byte, representing the address of the ADE7854A/ADE7858A/ADE7868A/ADE7878A, on the MOSI line (see Figure 99). The address is the same address byte used for reading a single register. The master sends data on the MOSI line starting with the first high to low transition of SCLK. The

SPI of the ADE7854A/ADE7858A/ADE7868A/ADE7878A samples data on the low to high transitions of SCLK.

The master then sends the 16-bit address of the first register that is to be read. After the ADE7854A/ADE7858A/ADE7868A/ADE7878A receive the last bit of the register address on a low to high transition of SCLK, the device begins to transmit the register contents on the MISO line when the next SCLK high to low transition occurs; the master samples the data on a low to high SCLK transition. After the master receives the last bit of the first register, the ADE7854A/ADE7858A/ADE7868A/ADE7878A send the contents of the next register. This process is repeated until the master sets the \overline{SS} and SCLK lines high and the communication ends. The data lines, MOSI and MISO, enter a high impedance state.

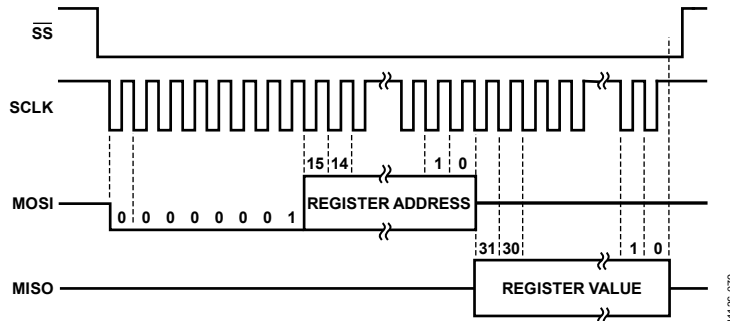

Figure 98. SPI Read Operation of a 32-Bit Register

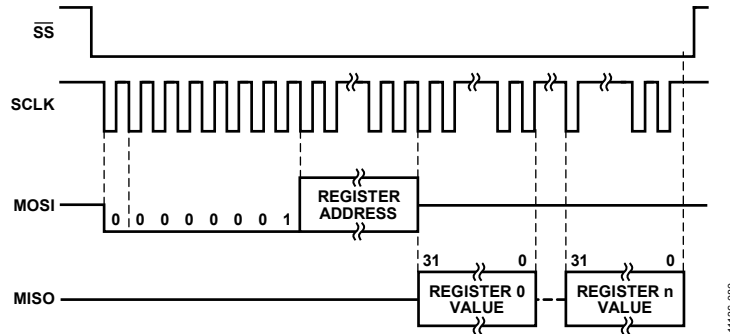

Figure 99. SPI Burst Read Operation

HSDC INTERFACE

The high speed data capture (HSDC) interface is disabled by default. It can be used only if the [ADE7854A/ADE7858A/ADE7868A/ADE7878A](#) are configured for the I²C interface. The SPI interface of the [ADE7854A/ADE7858A/ADE7868A/ADE7878A](#) cannot be used simultaneously with the HSDC interface.

When Bit 6 (HSDCEN) is set to 1 in the CONFIG register, the HSDC interface is enabled. If the HSDCEN bit is cleared to 0 (the default value), the HSDC interface is disabled. Setting this bit to 1 when the SPI interface is in use has no effect on the part.

The HSDC interface is used to send data to an external device (usually a microprocessor or a DSP); this data can consist of up to sixteen 32-bit words. The words represent the instantaneous values of the phase currents and voltages, neutral current, and active, reactive, and apparent powers. The registers transmitted are IAWV, VAWV, IBWV, VBWV, ICWV, VCWV, INWV, AVA, BVA, CVA, AWATT, BWATT, CWATT, AVAR, BVAR, and CVAR. These 24-bit registers are sign extended to 32 bits (see Figure 38). In the case of the [ADE7854A](#) and [ADE7858A](#), the INWV register is not available; instead, the HSDC interface transmits one 32-bit word that is always equal to 0. In addition, the AVAR, BVAR, and CVAR registers are not available in the [ADE7854A](#); instead, the HSDC transmits three 32-bit words that are always equal to 0.

HSDC can be interfaced with SPI or similar interfaces. HSDC is always a master of the communication and consists of three pins: HSA, HSD, and HSCLK.

- HSA represents the select signal. It stays active low or high when a word is transmitted, and it is usually connected to the select pin of the slave.
- HSD sends data to the slave and is usually connected to the data input pin of the slave.
- HSCLK is the serial clock line that is generated by the [ADE7854A/ADE7858A/ADE7868A/ADE7878A](#); HSCLK is usually connected to the serial clock input of the slave.

Figure 100 shows the connections between the [ADE7854A/ADE7858A/ADE7868A/ADE7878A](#) HSDC interface and a slave device containing an SPI interface.

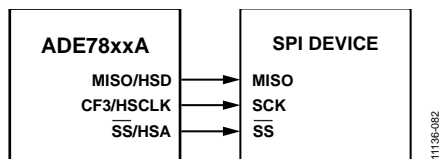

Figure 100. Connecting the [ADE7854A/ADE7858A/ADE7868A/ADE7878A](#) HSDC Interface to an SPI Slave

HSDC communication is managed by the HSDC_CFG register (see Table 51). It is recommended that the HSDC_CFG register be set to the desired value before the HSDC port is enabled using Bit 6 (HSDCEN) in the CONFIG register. In this way, the state of various pins belonging to the HSDC port do not accept levels

inconsistent with the desired HSDC behavior. After a hardware reset or after power-up, the HSD and HSA pins are set high.

Bit 0 (HCLK) in the HSDC_CFG register determines the serial clock frequency of the HSDC communication. When the HCLK bit is set to 0 (the default value), the clock frequency is 8 MHz. When the HCLK bit is set to 1, the clock frequency is 4 MHz. A bit of data is transmitted at every HSCLK high to low transition. The slave device that receives data from the HSDC interface samples the HSD line on the low to high transition of HSCLK.

The words can be transmitted as 32-bit packages or as 8-bit packages. When Bit 1 (HSIZE) in the HSDC_CFG register is set to 0 (the default value), the words are transmitted as 32-bit packages. When the HSIZE bit is set to 1, the registers are transmitted as 8-bit packages. The HSDC interface transmits the words MSB first.

When set to 1, Bit 2 (HGAP) introduces a gap of seven HSCLK cycles between packages. When the HGAP bit is cleared to 0 (the default value), no gap is introduced between packages, yielding the shortest communication time. When HGAP is set to 0, the HSIZE bit has no effect on the communication, and a data bit is placed on the HSD line at every HSCLK high to low transition.

Bits[4:3] (HXFER[1:0]) specify how many words are transmitted. When HXFER[1:0] is set to 00 (the default value), all 16 words are transmitted. When HXFER[1:0] is set to 01, only the words representing the instantaneous values of phase and neutral currents and phase voltages are transmitted in the following order: IAWV, VAWV, IBWV, VBWV, ICWV, VCWV, and one 32-bit word that is always equal to INWV. When HXFER[1:0] is set to 10, only the instantaneous values of phase powers are transmitted in the following order: AVA, BVA, CVA, AWATT, BWATT, CWATT, AVAR, BVAR, and CVAR. The value 11 for HXFER[1:0] is reserved, and writing it is equivalent to writing 00, the default value. See Table 51 for more information about the bit settings for each device.

Bit 5 (HSAPOL) specifies the polarity of the HSA function on the HSA pin during communication. When the HSAPOL bit is set to 0 (the default value), the HSA pin is active low during the communication; that is, HSA stays high when no communication is in progress. When a communication is executed, HSA is low when the 32-bit or 8-bit packages are transferred and high during the gaps. When the HSAPOL bit is set to 1, the HSA pin is active high during the communication; that is, HSA stays low when no communication is in progress. When a communication is executed, HSA is high when the 32-bit or 8-bit packages are transferred and is low during the gaps.

Bits[7:6] of the HSDC_CFG register are reserved. Any value written into these bits has no effect on HSDC behavior.

Figure 101 shows the HSDC transfer protocol for HGAP = 0, HXFER[1:0] = 00, and HSAPOL = 0. Note that the HSDC interface sets a data bit on the HSD line every HSCLK high to low transition; the value of the HSIZE bit is irrelevant.

Figure 102 shows the HSDC transfer protocol for HSIZE = 0, HGAP = 1, HXFER[1:0] = 00, and HSAPOL = 0. Note that the HSDC interface introduces a seven-cycle HCLK gap between every 32-bit word.

Figure 103 shows the HSDC transfer protocol for HSIZE = 1, HGAP = 1, HXFER[1:0] = 00, and HSAPOL = 0. Note that the HSDC interface introduces a seven-cycle HCLK gap between every 8-bit word.

Table 51 describes the HCLK, HSIZE, HGAP, HXFER[1:0], and HSAPOL bits in the HSDC_CFG register. Table 26 lists the time it takes to execute an HSDC data transfer for all HSDC_CFG register settings. For some settings, the transfer time is less than 125 μs (8 kHz), which is the update rate of the waveform sample registers; this means that the HSDC port transmits data with every sampling cycle. For settings in which the transfer time is greater than 125 μs, the HSDC port transmits data only in the first of two consecutive 8 kHz sampling cycles; that is, the port transmits registers at an effective rate of 4 kHz.

Table 26. Communication Times for Various HSDC Settings

HXFER[1:0]	HGAP	HSIZE ¹	HCLK	Communication Time (μs)
00	0	N/A	0	64
00	0	N/A	1	128
00	1	0	0	77.125
00	1	0	1	154.25
00	1	1	0	119.25
00	1	1	1	238.25
01	0	N/A	0	28
01	0	N/A	1	56
01	1	0	0	33.25
01	1	0	1	66.5
01	1	1	0	51.625
01	1	1	1	103.25
10	0	N/A	0	36
10	0	N/A	1	72
10	1	0	0	43
10	1	0	1	86
10	1	1	0	66.625
10	1	1	1	133.25

¹ N/A means not applicable.

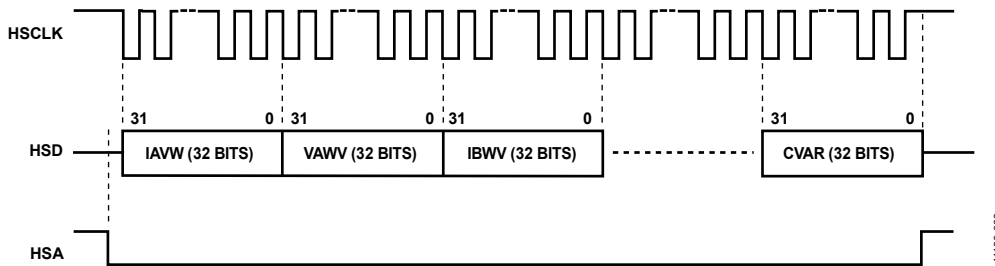

Figure 101. HSDC Communication for HGAP = 0, HXFER[1:0] = 00, and HSAPOL = 0; HSIZE Is Irrelevant

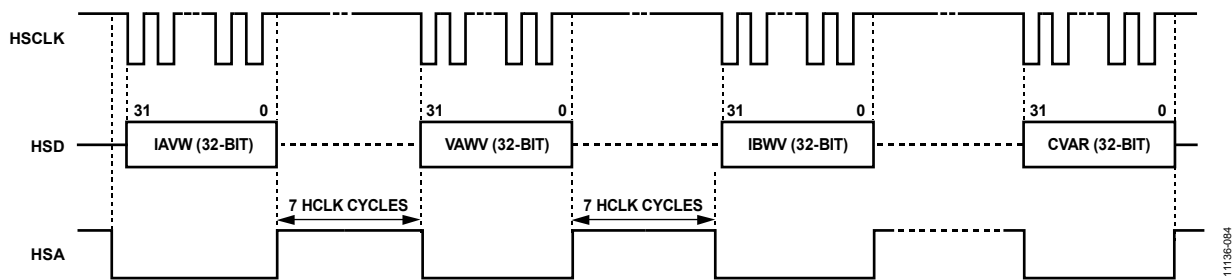

Figure 102. HSDC Communication for HSIZE = 0, HGAP = 1, HXFER[1:0] = 00, and HSAPOL = 0

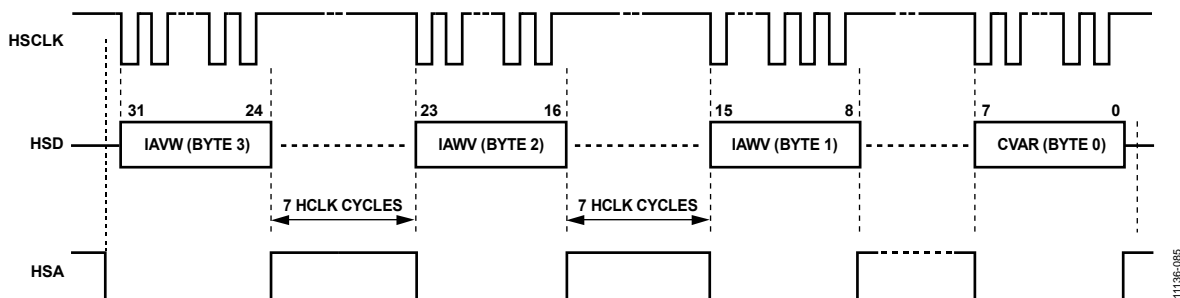

Figure 103. HSDC Communication for HSIZE = 1, HGAP = 1, HXFER[1:0] = 00, and HSAPOL = 0

REGISTER LIST

Note that dual function pin names are referenced by the relevant function only, for example, CF3 for the calibration frequency output function of the CF3/HSCCLK pin (see the Pin Configuration and Function Descriptions section for full pin mnemonics and descriptions).

Table 27. Register List Located in DSP Data Memory RAM

Address	Register Name	R/W ¹	Bit Length	Bit Length During Communication ²	Type ³	Default Value	Description
0x4380	AIGAIN	R/W	24	32 ZPSE	S	0x000000	Phase A current gain adjust.
0x4381	AVGAIN	R/W	24	32 ZPSE	S	0x000000	Phase A voltage gain adjust.
0x4382	BIGAIN	R/W	24	32 ZPSE	S	0x000000	Phase B current gain adjust.
0x4383	BVGAIN	R/W	24	32 ZPSE	S	0x000000	Phase B voltage gain adjust.
0x4384	CIGAIN	R/W	24	32 ZPSE	S	0x000000	Phase C current gain adjust.
0x4385	CVGAIN	R/W	24	32 ZPSE	S	0x000000	Phase C voltage gain adjust.
0x4386	NIGAIN	R/W	24	32 ZPSE	S	0x000000	Neutral current gain adjust (ADE7868A and ADE7878A only).
0x4387	AIRMSOS	R/W	24	32 ZPSE	S	0x000000	Phase A current rms offset.
0x4388	AVRMSOS	R/W	24	32 ZPSE	S	0x000000	Phase A voltage rms offset.
0x4389	BIRMSOS	R/W	24	32 ZPSE	S	0x000000	Phase B current rms offset.
0x438A	BVRMSOS	R/W	24	32 ZPSE	S	0x000000	Phase B voltage rms offset.
0x438B	CIRMSOS	R/W	24	32 ZPSE	S	0x000000	Phase C current rms offset.
0x438C	CVRMSOS	R/W	24	32 ZPSE	S	0x000000	Phase C voltage rms offset.
0x438D	NIRMSOS	R/W	24	32 ZPSE	S	0x000000	Neutral current rms offset (ADE7868A and ADE7878A only).
0x438E	AVAGAIN	R/W	24	32 ZPSE	S	0x000000	Phase A apparent power gain adjust.
0x438F	BVAGAIN	R/W	24	32 ZPSE	S	0x000000	Phase B apparent power gain adjust.
0x4390	CVAGAIN	R/W	24	32 ZPSE	S	0x000000	Phase C apparent power gain adjust.
0x4391	AWGAIN	R/W	24	32 ZPSE	S	0x000000	Phase A total active power gain adjust.
0x4392	AWATTOS	R/W	24	32 ZPSE	S	0x000000	Phase A total active power offset adjust.
0x4393	BWGAIN	R/W	24	32 ZPSE	S	0x000000	Phase B total active power gain adjust.
0x4394	BWATTOS	R/W	24	32 ZPSE	S	0x000000	Phase B total active power offset adjust.
0x4395	CWGAIN	R/W	24	32 ZPSE	S	0x000000	Phase C total active power gain adjust.
0x4396	CWATTOS	R/W	24	32 ZPSE	S	0x000000	Phase C total active power offset adjust.
0x4397	AVARGAIN	R/W	24	32 ZPSE	S	0x000000	Phase A total reactive power gain adjust (ADE7858A , ADE7868A , ADE7878A only).
0x4398	AVAROS	R/W	24	32 ZPSE	S	0x000000	Phase A total reactive power offset adjust (ADE7858A , ADE7868A , ADE7878A only).
0x4399	BVARGAIN	R/W	24	32 ZPSE	S	0x000000	Phase B total reactive power gain adjust (ADE7858A , ADE7868A , ADE7878A only).
0x439A	BVAROS	R/W	24	32 ZPSE	S	0x000000	Phase B total reactive power offset adjust (ADE7858A , ADE7868A , ADE7878A only).
0x439B	CVARGAIN	R/W	24	32 ZPSE	S	0x000000	Phase C total reactive power gain adjust (ADE7858A , ADE7868A , ADE7878A only).
0x439C	CVAROS	R/W	24	32 ZPSE	S	0x000000	Phase C total reactive power offset adjust (ADE7858A , ADE7868A , ADE7878A only).
0x439D	AFWGAIN	R/W	24	32 ZPSE	S	0x000000	Phase A fundamental active power gain adjust. Location reserved for the ADE7854A , ADE7858A , and ADE7868A .
0x439E	AFWATTOS	R/W	24	32 ZPSE	S	0x000000	Phase A fundamental active power offset adjust. Location reserved for the ADE7854A , ADE7858A , and ADE7878A .
0x439F	BFWGAIN	R/W	24	32 ZPSE	S	0x000000	Phase B fundamental active power gain adjust (ADE7878A only).
0x43A0	BFWATTOS	R/W	24	32 ZPSE	S	0x000000	Phase B fundamental active power offset adjust (ADE7878A only).
0x43A1	CFWGAIN	R/W	24	32 ZPSE	S	0x000000	Phase C fundamental active power gain adjust (ADE7878A only).

Address	Register Name	R/W ¹	Bit Length	Bit Length During Communication ²	Type ³	Default Value	Description
0x43A2	CFWATTOS	R/W	24	32 ZPSE	S	0x000000	Phase C fundamental active power offset adjust (ADE7878A only).
0x43A3	AFVARGAIN	R/W	24	32 ZPSE	S	0x000000	Phase A fundamental reactive power gain adjust (ADE7878A only).
0x43A4	AFVAROS	R/W	24	32 ZPSE	S	0x000000	Phase A fundamental reactive power offset adjust (ADE7878A only).
0x43A5	BFVARGAIN	R/W	24	32 ZPSE	S	0x000000	Phase B fundamental reactive power gain adjust (ADE7878A only).
0x43A6	BFVAROS	R/W	24	32 ZPSE	S	0x000000	Phase B fundamental reactive power offset adjust (ADE7878A only).
0x43A7	CFVARGAIN	R/W	24	32 ZPSE	S	0x000000	Phase C fundamental reactive power gain adjust (ADE7878A only).
0x43A8	CFVAROS	R/W	24	32 ZPSE	S	0x000000	Phase C fundamental reactive power offset adjust (ADE7878A only).
0x43A9	VATHR1	R/W	24	32 ZP	U	0x000000	Most significant 24 bits of VATHR[47:0] threshold used in phase apparent power datapath.
0x43AA	VATHR0	R/W	24	32 ZP	U	0x000000	Least significant 24 bits of VATHR[47:0] threshold used in phase apparent power datapath.
0x43AB	WTHR1	R/W	24	32 ZP	U	0x000000	Most significant 24 bits of WTHR[47:0] threshold used in phase total/fundamental active power datapath.
0x43AC	WTHR0	R/W	24	32 ZP	U	0x000000	Least significant 24 bits of WTHR[47:0] threshold used in phase total/fundamental active power datapath.
0x43AD	VARTHR1	R/W	24	32 ZP	U	0x000000	Most significant 24 bits of VARTHR[47:0] threshold used in phase total/fundamental reactive power datapath (ADE7858A, ADE7868A, ADE7878A only).
0x43AE	VARTHR0	R/W	24	32 ZP	U	0x000000	Least significant 24 bits of VARTHR[47:0] threshold used in phase total/fundamental reactive power datapath (ADE7858A, ADE7868A, ADE7878A only).
0x43AF	Reserved	N/A ⁴	N/A ⁴	N/A ⁴	N/A ⁴	0x000000	Keep this memory location at 0x000000 for proper operation.
0x43B0	VANOLOAD	R/W	24	32 ZPSE	S	0x0000000	No load threshold in the apparent power datapath.
0x43B1	APNOLOAD	R/W	24	32 ZPSE	S	0x0000000	No load threshold in the total/fundamental active power datapath.
0x43B2	VARNLOAD	R/W	24	32 ZPSE	S	0x0000000	No load threshold in the total/fundamental reactive power datapath. Location reserved for the ADE7854A.
0x43B3	VLEVEL	R/W	24	32 ZPSE	S	0x000000	Register used in the algorithm that computes the fundamental active and reactive powers (ADE7878A only).
0x43B4	Reserved	N/A ⁴	N/A ⁴	N/A ⁴	N/A ⁴	0x000000	Do not write to this location.
0x43B5	DICOEFF	R/W	24	32 ZPSE	S	0x000000	Register used in the digital integrator algorithm. If the integrator is turned on, the DICOEFF register must be set at 0xFF8000. In practice, it is transmitted as 0xFFF8000.
0x43B6	HPFDIS	R/W	24	32 ZP	U	0x000000	Disables/enables the HPF in the current datapath. See Table 31.
0x43B7	Reserved	N/A ⁴	N/A ⁴	N/A ⁴	N/A ⁴	0x000000	Keep this memory location at 0x000000 for proper operation.
0x43B8	ISUMLVL	R/W	24	32 ZPSE	S	0x000000	Threshold used in comparison between the sum of phase currents and the neutral current (ADE7868A and ADE7878A only).

Address	Register Name	R/W ¹	Bit Length	Bit Length During Communication ²	Type ³	Default Value	Description
0x43B9 to 0x43BE	Reserved	N/A ⁴	N/A ⁴	N/A ⁴	N/A ⁴	0x000000	Keep these memory locations at 0x000000 for proper operation.
0x43BF	ISUM	R	28	32 ZP	S	N/A ⁴	Sum of IAWV, IBWV, and ICWV registers (ADE7868A and ADE7878A only).
0x43C0	AIRMS	R	24	32 ZP	S	N/A ⁴	Phase A current rms value.
0x43C1	AVRMS	R	24	32 ZP	S	N/A ⁴	Phase A voltage rms value.
0x43C2	BIRMS	R	24	32 ZP	S	N/A ⁴	Phase B current rms value.
0x43C3	BVRMS	R	24	32 ZP	S	N/A ⁴	Phase B voltage rms value.
0x43C4	CIRMS	R	24	32 ZP	S	N/A ⁴	Phase C current rms value.
0x43C5	CVRMS	R	24	32 ZP	S	N/A ⁴	Phase C voltage rms value.
0x43C6	NIRMS	R	24	32 ZP	S	N/A ⁴	Neutral current rms value (ADE7868A and ADE7878A only).
0x43C7 to 0x43FF	Reserved	N/A ⁴	N/A ⁴	N/A ⁴	N/A ⁴	N/A ⁴	For proper operation, do not write to these memory locations.

¹ R = read only; R/W = read and write.

² 32 ZPSE = 24-bit signed register that is transmitted as a 32-bit word with four MSBs padded with 0s and sign extended to 28 bits. 32 ZP = 28- or 24-bit signed or unsigned register that is transmitted as a 32-bit word with four MSBs or eight MSBs, respectively, padded with 0s.

³ U = unsigned register; S = signed register in twos complement format.

⁴ N/A = not applicable.

Table 28. Internal DSP Memory RAM Registers

Address	Register Name	R/W ¹	Bit Length	Type ²	Default Value	Description
0xE203	Reserved	R/W	16	U	0x0000	For proper operation, do not write to this memory location.
0xE228	Run	R/W	16	U	0x0000	The run register starts and stops the DSP (see the Digital Signal Processor section).

¹ R/W = read and write.

² U = unsigned register.

Table 29. Billable Registers

Address	Register Name	R/W ¹	Bit Length	Type ²	Default Value	Description
0xE400	AWATTHR	R	32	S	0x00000000	Phase A total active energy accumulation.
0xE401	BWATTHR	R	32	S	0x00000000	Phase B total active energy accumulation.
0xE402	CWATTHR	R	32	S	0x00000000	Phase C total active energy accumulation.
0xE403	AFWATTHR	R	32	S	0x00000000	Phase A fundamental active energy accumulation (ADE7878A only).
0xE404	BFWATTHR	R	32	S	0x00000000	Phase B fundamental active energy accumulation (ADE7878A only).
0xE405	CFWATTHR	R	32	S	0x00000000	Phase C fundamental active energy accumulation (ADE7878A only).
0xE406	AVARHR	R	32	S	0x00000000	Phase A total reactive energy accumulation (ADE7858A, ADE7868A, and ADE7878A only).
0xE407	BVARHR	R	32	S	0x00000000	Phase B total reactive energy accumulation (ADE7858A, ADE7868A, and ADE7878A only).
0xE408	CVARHR	R	32	S	0x00000000	Phase C total reactive energy accumulation (ADE7858A, ADE7868A, and ADE7878A only).
0xE409	AFVARHR	R	32	S	0x00000000	Phase A fundamental reactive energy accumulation (ADE7878A only).
0xE40A	BFVARHR	R	32	S	0x00000000	Phase B fundamental reactive energy accumulation (ADE7878A only).
0xE40B	CFVARHR	R	32	S	0x00000000	Phase C fundamental reactive energy accumulation (ADE7878A only).
0xE40C	AVAHR	R	32	S	0x00000000	Phase A apparent energy accumulation.
0xE40D	BVAHR	R	32	S	0x00000000	Phase B apparent energy accumulation.
0xE40E	CVAHR	R	32	S	0x00000000	Phase C apparent energy accumulation.

¹ R = read only.

² S = signed register in twos complement format.

Table 30. Configuration and Power Quality Registers

Address	Register Name	R/W ^{1,2}	Bit Length ²	Bit Length During Communication ^{2,3}	Type ^{2,4}	Default Value ²	Description
0xE500	IPEAK	R	32	32	U	N/A	Current peak register. For more information, see Figure 51 and Table 32.
0xE501	VPEAK	R	32	32	U	N/A	Voltage peak register. For more information, see Figure 51 and Table 33.
0xE502	STATUS0	R/W	32	32	U	N/A	Interrupt Status Register 0. See Table 34.
0xE503	STATUS1	R/W	32	32	U	N/A	Interrupt Status Register 1. See Table 35.
0xE504	AIMAV	R	20	32 ZP	U	N/A	Phase A current mean absolute value computed during PSM0 and PSM1 modes (ADE7868A and ADE7878A only).
0xE505	BIMAV	R	20	32 ZP	U	N/A	Phase B current mean absolute value computed during PSM0 and PSM1 modes (ADE7868A and ADE7878A only).
0xE506	CIMAV	R	20	32 ZP	U	N/A	Phase C current mean absolute value computed during PSM0 and PSM1 modes (ADE7868A and ADE7878A only).
0xE507	OILVL	R/W	24	32 ZP	U	0xFFFFFFFF	Overcurrent threshold.
0xE508	OVLVL	R/W	24	32 ZP	U	0xFFFFFFFF	Overvoltage threshold.
0xE509	SAGLVL	R/W	24	32 ZP	U	0x000000	Voltage sag level threshold.
0xE50A	MASK0	R/W	32	32	U	0x00000000	Interrupt Enable Register 0. See Table 36.
0xE50B	MASK1	R/W	32	32	U	0x00000000	Interrupt Enable Register 1. See Table 37.
0xE50C	IAWV	R	24	32 SE	S	N/A	Instantaneous value of Phase A current.
0xE50D	IBWV	R	24	32 SE	S	N/A	Instantaneous value of Phase B current.
0xE50E	ICWV	R	24	32 SE	S	N/A	Instantaneous value of Phase C current.
0xE50F	INWV	R	24	32 SE	S	N/A	Instantaneous value of neutral current (ADE7868A and ADE7878A only).
0xE510	VAWV	R	24	32 SE	S	N/A	Instantaneous value of Phase A voltage.
0xE511	VBWV	R	24	32 SE	S	N/A	Instantaneous value of Phase B voltage.
0xE512	VCWV	R	24	32 SE	S	N/A	Instantaneous value of Phase C voltage.
0xE513	AWATT	R	24	32 SE	S	N/A	Instantaneous value of Phase A total active power.
0xE514	BWATT	R	24	32 SE	S	N/A	Instantaneous value of Phase B total active power.
0xE515	CWATT	R	24	32 SE	S	N/A	Instantaneous value of Phase C total active power.
0xE516	AVAR	R	24	32 SE	S	N/A	Instantaneous value of Phase A total reactive power (ADE7858A, ADE7868A, and ADE7878A only).
0xE517	BVAR	R	24	32 SE	S	N/A	Instantaneous value of Phase B total reactive power (ADE7858A, ADE7868A, and ADE7878A only).
0xE518	CVAR	R	24	32 SE	S	N/A	Instantaneous value of Phase C total reactive power (ADE7858A, ADE7868A, and ADE7878A only).
0xE519	AVA	R	24	32 SE	S	N/A	Instantaneous value of Phase A apparent power.
0xE51A	BVA	R	24	32 SE	S	N/A	Instantaneous value of Phase B apparent power.
0xE51B	CVA	R	24	32 SE	S	N/A	Instantaneous value of Phase C apparent power.
0xE51C to 0xE51E	Reserved	N/A	N/A	N/A	N/A	N/A	For proper operation, do not write to these memory locations.
0xE51F	CHECKSUM	R	32	32	U	N/A	Checksum verification. See the Checksum Register section for more information.

Address	Register Name	R/W ^{1,2}	Bit Length ²	Bit Length During Communication ^{2,3}	Type ^{2,4}	Default Value ²	Description
0xE520	VNOM	R/W	24	32 ZP	S	0x000000	Nominal phase voltage rms used in the alternative computation of the apparent power. When the VNOMxEN bit is set, the applied voltage input in the corresponding phase is ignored and all corresponding rms voltage instances are replaced by the value in the VNOM register.
0xE521 to 0xE52F	Reserved	N/A	N/A	N/A	N/A	N/A	For proper operation, do not write to these memory locations.
0xE530	IARMS_LRIP	R	24	32 ZP	S	N/A	1.024 sec average of Phase A current rms.
0xE531	VARMS_LRIP	R	24	32 ZP	S	N/A	1.024 sec average of Phase A voltage rms.
0xE532	IBRMS_LRIP	R	24	32 ZP	S	N/A	1.024 sec average of Phase B current rms.
0xE533	VBRMS_LRIP	R	24	32 ZP	S	N/A	1.024 sec average of Phase B voltage rms.
0xE534	ICRMS_LRIP	R	24	32 ZP	S	N/A	1.024 sec average of Phase C current rms.
0xE535	VCRMS_LRIP	R	24	32 ZP	S	N/A	1.024 sec average of Phase C voltage rms.
0xE536	INRMS_LRIP	R	24	32 ZP	S	N/A	1.024 sec average of the neutral current rms.
0xE537 to 0xE5FE	Reserved	N/A	N/A	N/A	N/A	N/A	For proper operation, do not write to these memory locations.
0xE5FF	LAST_RWDATA_32	R	32	32	U	N/A	Contains the data from the last successful 32-bit register communication.
0xE600	PHSTATUS	R	16	16	U	N/A	Phase peak register. See Table 38.
0xE601	ANGLE0	R	16	16	U	N/A	Time Delay 0. See the Time Interval Between Phases section for more information.
0xE602	ANGLE1	R	16	16	U	N/A	Time Delay 1. See the Time Interval Between Phases section for more information.
0xE603	ANGLE2	R	16	16	U	N/A	Time Delay 2. See the Time Interval Between Phases section for more information.
0xE604 to 0xE606	Reserved	N/A	N/A	N/A	N/A	N/A	For proper operation, do not write to these memory locations.
0xE607	Period	R	16	16	U	N/A	Network line period.
0xE608	PHNOLOAD	R	16	16	U	N/A	Phase no load register. See Table 39.
0xE609 to 0xE60B	Reserved	N/A	N/A	N/A	N/A	N/A	For proper operation, do not write to these memory locations.
0xE60C	LINECYC	R/W	16	16	U	0xFFFF	Line cycle accumulation mode count.
0xE60D	ZXTOUT	R/W	16	16	U	0xFFFF	Zero-crossing timeout count.
0xE60E	COMPmode	R/W	16	16	U	0x01FF	Computation-mode register. See Table 40.
0xE60F	Gain	R/W	16	16	U	0x0000	PGA gains at ADC inputs. See Table 41.
0xE610	CFMODE	R/W	16	16	U	0x0E88	CFx configuration register. See Table 42.
0xE611	CF1DEN	R/W	16	16	U	0x0000	CF1 denominator.
0xE612	CF2DEN	R/W	16	16	U	0x0000	CF2 denominator.
0xE613	CF3DEN	R/W	16	16	U	0x0000	CF3 denominator.
0xE614	APHCAL	R/W	10	16 ZP	S	0x0000	Phase calibration of Phase A. See Table 43.
0xE615	BPHCAL	R/W	10	16 ZP	S	0x0000	Phase calibration of Phase B. See Table 43.
0xE616	CPHCAL	R/W	10	16 ZP	S	0x0000	Phase calibration of Phase C. See Table 43.
0xE617	PHSIGN	R	16	16	U	N/A	Power sign register. See Table 44.
0xE618	CONFIG	R/W	16	16	U	0x0000	ADE7878A configuration register. See Table 45.
0xE619 to 0xE6FD	Reserved	N/A	N/A	N/A	N/A	N/A	For proper operation, do not write to these memory locations.
0xE6FE	LAST_ADDR	R	16	16	U	N/A	The address of the register successfully accessed during the last read/write operation.
0xE6FF	LAST_RWDATA_16	R	16	16	U	N/A	Contains the data from the last successful 16-bit register communication.
0xE700	MMODE	R/W	8	8	U	0x1C	Measurement mode register. See Table 47.

Address	Register Name	R/W ^{1,2}	Bit Length ²	Bit Length During Communication ^{2,3}	Type ^{2,4}	Default Value ²	Description
0xE701	ACCMODE	R/W	8	8	U	0x00	Accumulation mode register. See Table 48.
0xE702	LCYCMODE	R/W	8	8	U	0x78	Line accumulation mode behavior. See Table 50.
0xE703	PEAKCYC	R/W	8	8	U	0x00	Peak detection half line cycles.
0xE704	SAGCYC	R/W	8	8	U	0x00	Sag detection half line cycles.
0xE705	CFCYC	R/W	8	8	U	0x01	Number of CF pulses between two consecutive energy latches. See the Synchronizing Energy Registers with the CFx Outputs section.
0xE706	HSDC_CFG	R/W	8	8	U	0x00	HSDC configuration register. See Table 51.
0xE707	Version	R	8	8	U		Version of the die.
0xE708 to 0xE73F	Reserved	N/A	N/A	N/A	N/A	N/A	For proper operation, do not write to these memory locations.
0xE740	CONFIG_A	R/W	8	8	U	0x00	Configuration registers for the power filtering.
0xE741 to 0xE7FB	Reserved	N/A	N/A	N/A	N/A	N/A	For proper operation, do not write to these memory locations.
0xE7FC	LAST_RWDATA_8	R	8	8	U	N/A	Contains the data from the last successful 8-bit register communication.
0xE7FD	LAST_OP	R	8	8	U	N/A	Indicates the type, read or write, of the last successful read/write operation.
0xEBFF	Reserved		8	8			When SPI is chosen as the active port, use this address to manipulate the \overline{SS} /HSA pin. See the Serial Interfaces section.
0xEC00	LPOILVL	R/W	8	8	U	0x07	Overcurrent threshold used during PSM2 mode (ADE7868A and ADE7878A only). See Table 52.
0xEC01	CONFIG2	R/W	8	8	U	0x00	Configuration register used during PSM1 mode. See Table 53.

¹ R = read only; R/W = read and write.

² N/A = not applicable.

³ 32 ZP = 24- or 20-bit signed or unsigned register that is transmitted as a 32-bit word with 8 or 12 MSBs, respectively, padded with 0s. 32 SE = 24-bit signed register that is transmitted as a 32-bit word sign extended to 32 bits. 16 ZP = 10-bit unsigned register that is transmitted as a 16-bit word with six MSBs padded with 0s.

⁴ U = unsigned register; S = signed register in twos complement format.

Table 31. HPFDIS Register (Address 0x43B6)

Bits	Default Value	Description
[23:0]	000000	HPFDIS = 0x00000000 enables all high-pass filters in voltage and current channels. Setting the register to any nonzero value disables all high-pass filters.

Table 32. IPEAK Register (Address 0xE500)

Bits	Bit Name	Default Value	Description
[23:0]	IPEAKVAL[23:0]	0	These bits contain the peak value determined in the current channel.
24	IPPHASE[0]	0	When this bit is set to 1, the Phase A current generates the IPEAKVAL[23:0] value.
25	IPPHASE[1]	0	When this bit is set to 1, the Phase B current generates the IPEAKVAL[23:0] value.
26	IPPHASE[2]	0	When this bit is set to 1, the Phase C current generates the IPEAKVAL[23:0] value.
[31:27]		00000	These bits are always set to 00000.

Table 33. VPEAK Register (Address 0xE501)

Bits	Bit Name	Default Value	Description
[23:0]	VPEAKVAL[23:0]	0	These bits contain the peak value determined in the voltage channel.
24	VPPHASE[0]	0	When this bit is set to 1, the Phase A voltage generates the VPEAKVAL[23:0] value.
25	VPPHASE[1]	0	When this bit is set to 1, the Phase B voltage generates the VPEAKVAL[23:0] value.
26	VPPHASE[2]	0	When this bit is set to 1, the Phase C voltage generates the VPEAKVAL[23:0] value.
[31:27]		00000	These bits are always set to 00000.

Table 34. STATUS0 Register (Address 0xE502)

Bits	Bit Name	Default Value	Description
0	AEHF	0	When this bit is set to 1, it indicates that Bit 30 in one of the total active energy registers (AWATTHR, BWATTHR, or CWATTHR) has changed.
1	FAEHF	0	When this bit is set to 1, it indicates that Bit 30 in one of the fundamental active energy registers (FWATTHR, BFWATTHR, or CFWATTHR) has changed. This bit is always set to 0 for the ADE7854A , ADE7858A , and ADE7868A .
2	REHF	0	When this bit is set to 1, it indicates that Bit 30 in one of the total reactive energy registers (AVARHR, BVARHR, or CVARHR) has changed. This bit is always set to 0 for the ADE7854A .
3	FREHF	0	When this bit is set to 1, it indicates that Bit 30 in one of the fundamental reactive energy registers (AFVARHR, BFVARHR, or CFVARHR) has changed. This bit is always set to 0 for the ADE7854A , ADE7858A , and ADE7868A .
4	VAEHF	0	When this bit is set to 1, it indicates that Bit 30 in one of the apparent energy registers (AVAHR, BVAHR, or CVAHR) has changed.
5	LEENERGY	0	When this bit is set to 1, in line energy accumulation mode, it indicates the end of an integration over an integer number of half line cycles set in the LINECYC register.
6	REVAPA	0	When this bit is set to 1, it indicates that the Phase A active power identified by Bit 6 (REVAPSEL) in the ACCMODE register (total or fundamental) has changed sign. The sign itself is indicated in Bit 0 (AWSIGN) of the PHSIGN register (see Table 44).
7	REVAPB	0	When this bit is set to 1, it indicates that the Phase B active power identified by Bit 6 (REVAPSEL) in the ACCMODE register (total or fundamental) has changed sign. The sign itself is indicated in Bit 1 (BWSIGN) of the PHSIGN register (see Table 44).
8	REVAPC	0	When this bit is set to 1, it indicates that the Phase C active power identified by Bit 6 (REVAPSEL) in the ACCMODE register (total or fundamental) has changed sign. The sign itself is indicated in Bit 2 (CWSIGN) of the PHSIGN register (see Table 44).
9	REVPSUM1	0	When this bit is set to 1, it indicates that the sum of all phase powers in the CF1 datapath has changed sign. The sign itself is indicated in Bit 3 (SUM1SIGN) of the PHSIGN register (see Table 44).
10	REVRPA	0	When this bit is set to 1, it indicates that the Phase A reactive power identified by Bit 7 (REVRPSEL) in the ACCMODE register (total or fundamental) has changed sign. The sign itself is indicated in Bit 4 (AVARSIGN) of the PHSIGN register (see Table 44). This bit is always set to 0 for the ADE7854A .
11	REVRPB	0	When this bit is set to 1, it indicates that the Phase B reactive power identified by Bit 7 (REVRPSEL) in the ACCMODE register (total or fundamental) has changed sign. The sign itself is indicated in Bit 5 (BVARSIGN) of the PHSIGN register (see Table 44). This bit is always set to 0 for the ADE7854A .
12	REVRPC	0	When this bit is set to 1, it indicates that the Phase C reactive power identified by Bit 7 (REVRPSEL) in the ACCMODE register (total or fundamental) has changed sign. The sign itself is indicated in Bit 6 (CVARSIGN) of the PHSIGN register (see Table 44). This bit is always set to 0 for the ADE7854A .
13	REVPSUM2	0	When this bit is set to 1, it indicates that the sum of all phase powers in the CF2 datapath has changed sign. The sign itself is indicated in Bit 7 (SUM2SIGN) of the PHSIGN register (see Table 44).
14	CF1		When this bit is set to 1, it indicates that a high-to-low transition has occurred at the CF1 pin; that is, an active low pulse has been generated. The bit is set even if the CF1 output is disabled by setting Bit 9 (CF1DIS) to 1 in the CFMODE register. The type of power used at the CF1 pin is determined by Bits[2:0] (CF1SEL[2:0]) in the CFMODE register (see Table 42).
15	CF2		When this bit is set to 1, it indicates a high-to-low transition has occurred at the CF2 pin; that is, an active low pulse has been generated. The bit is set even if the CF2 output is disabled by setting Bit 10 (CF2DIS) to 1 in the CFMODE register. The type of power used at the CF2 pin is determined by Bits[5:3] (CF2SEL[2:0]) in the CFMODE register (see Table 42).
16	CF3		When this bit is set to 1, it indicates a high to low transition has occurred at the CF3 pin; that is, an active low pulse has been generated. The bit is set even if the CF3 output is disabled by setting Bit 11 (CF3DIS) to 1 in the CFMODE register. The type of power used at the CF3 pin is determined by Bits[8:6] (CF3SEL[2:0]) in the CFMODE register (see Table 42).
17	DREADY	0	When this bit is set to 1, it indicates that all periodical (at 8 kHz rate) DSP computations have finished.
18	REVPSUM3	0	When this bit is set to 1, it indicates that the sum of all phase powers in the CF3 datapath has changed sign. The sign itself is indicated in Bit 8 (SUM3SIGN) of the PHSIGN register (see Table 44).
[31:19]	Reserved	0000000000000	Reserved. These bits are always set to 0.

Table 35. STATUS1 Register (Address 0xE503)

Bits	Bit Name	Default Value	Description
0	NLOAD	0	When this bit is set to 1, it indicates that at least one phase entered a no load condition based on total active and reactive powers. The phase is indicated in Bits[2:0] (NLPHASE[x]) in the PHNLOAD register (see Table 39).
1	FNLOAD	0	When this bit is set to 1, it indicates that at least one phase entered a no load condition based on fundamental active and reactive powers. The phase is indicated in Bits[5:3] (FNLPHASE[x]) in the PHNLOAD register (see Table 39). This bit is always set to 0 for the ADE7854A , ADE7858A , and ADE7868A .
2	VANLOAD	0	When this bit is set to 1, it indicates that at least one phase entered a no load condition based on apparent power. The phase is indicated in Bits[8:6] (VANLPHASE[x]) in the PHNLOAD register (see Table 39).
3	ZXTOVA	0	When this bit is set to 1, it indicates a missing zero crossing on the Phase A voltage.
4	ZXTOVB	0	When this bit is set to 1, it indicates a missing zero crossing on the Phase B voltage.
5	ZXTOVC	0	When this bit is set to 1, it indicates a missing zero crossing on the Phase C voltage.
6	ZXTOIA	0	When this bit is set to 1, it indicates a missing zero crossing on the Phase A current.
7	ZXTOIB	0	When this bit is set to 1, it indicates a missing zero crossing on the Phase B current.
8	ZXTOIC	0	When this bit is set to 1, it indicates a missing zero crossing on the Phase C current.
9	ZXVA	0	When this bit is set to 1, it indicates the detection of a zero crossing on the Phase A voltage.
10	ZXVB	0	When this bit is set to 1, it indicates the detection of a zero crossing on the Phase B voltage.
11	ZXVC	0	When this bit is set to 1, it indicates the detection of a zero crossing on the Phase C voltage.
12	ZXIA	0	When this bit is set to 1, it indicates the detection of a zero crossing on the Phase A current.
13	ZXIB	0	When this bit is set to 1, it indicates the detection of a zero crossing on the Phase B current.
14	ZXIC	0	When this bit is set to 1, it indicates the detection of a zero crossing on the Phase C current.
15	RSTDONE	1	In the case of a software reset command, Bit 7 (SWRST) is set to 1 in the CONFIG register; for a transition from PSM1, PSM2, or PSM3 to PSM0, or for a hardware reset, this bit is set to 1 at the end of the transition process after all registers have changed their values to default. The IRQ1 pin goes low to signal this moment because this interrupt cannot be disabled.
16	Sag	0	When this bit is set to 1, it indicates a sag event has occurred on one of the phases indicated by Bits[14:12] (VSPHASE[x]) in the PHSTATUS register (see Table 38).
17	OI	0	When this bit is set to 1, it indicates an overcurrent event has occurred on one of the phases indicated by Bits[5:3] (OIPHASE[x]) in the PHSTATUS register (see Table 38).
18	OV	0	When this bit is set to 1, it indicates an overvoltage event has occurred on one of the phases indicated by Bits[11:9] (OVPHASE[x]) in the PHSTATUS register (see Table 38).
19	SEQERR	0	When this bit is set to 1, it indicates that a negative to positive zero crossing on Phase A voltage was not followed by a negative to positive zero crossing on Phase B voltage; instead, the zero crossing occurred on the Phase C voltage.
20	MISMTCH	0	When this bit is set to 1, it indicates $ ISUM - INWV > ISUMLVL$ where <i>ISUMLVL</i> is indicated in the ISUMLVL register. This bit is always set to 0 for the ADE7854A and ADE7858A .
21	Reserved	1	Reserved. This bit is always set to 1.
22	Reserved	0	Reserved. This bit is always set to 0.
23	PKI	0	When this bit is set to 1, it indicates that the period used to detect the peak value in the current channel has ended. The IPEAK register contains the peak value and the phase where the peak has been detected (see Table 32).
24	PKV	0	When this bit is set to 1, it indicates that the period used to detect the peak value in the voltage channel has ended. VPEAK register contains the peak value and the phase where the peak has been detected (see Table 33).
25	CRC	0	When this bit is set to 1, it indicates that the value of the checksum register has changed.
[31:26]	Reserved	000000	Reserved. These bits are always set to 0.

Table 36. MASK0 Register (Address 0xE50A)

Bits	Bit Name	Default Value	Description
0	AEHF	0	When this bit is set to 1, it enables an interrupt when Bit 30 in one of the total active energy registers (AWATTHR, BWATTHR, or CWATTHR) changes.
1	FAEHF	0	When this bit is set to 1, it enables an interrupt when Bit 30 in one of the fundamental active energy registers (AFWATTHR, BFWATTHR, or CFWATTHR) changes. Setting this bit to 1 does not have any consequence for the ADE7854A , ADE7858A , or ADE7868A .
2	REHF	0	When this bit is set to 1, it enables an interrupt when Bit 30 in one of the total reactive energy registers (AVARHR, BVARHR, CVARHR) changes. Setting this bit to 1 does not have any consequence for the ADE7854A .
3	FREHF	0	When this bit is set to 1, it enables an interrupt when Bit 30 in one of the fundamental reactive energy registers (AFVARHR, BFWARHR, or CFVARHR) changes. Setting this bit to 1 does not have any consequence for the ADE7854A , ADE7858A , and ADE7868A .
4	VAEHF	0	When this bit is set to 1, it enables an interrupt when Bit 30 in one of the apparent energy registers (AVAHR, BVAHR, or CVAHR) changes.
5	LENERGY	0	When this bit is set to 1, in line energy accumulation mode, it enables an interrupt at the end of an integration over an integer number of half line cycles set in the LINECYC register.
6	REVAPA	0	When this bit is set to 1, it enables an interrupt when the Phase A active power identified by Bit 6 (REVAPSEL) in the ACCMODE register (total or fundamental) changes sign.
7	REVAPB	0	When this bit is set to 1, it enables an interrupt when the Phase B active power identified by Bit 6 (REVAPSEL) in the ACCMODE register (total or fundamental) changes sign.
8	REVAPC	0	When this bit is set to 1, it enables an interrupt when the Phase C active power identified by Bit 6 (REVAPSEL) in the ACCMODE register (total or fundamental) changes sign.
9	REVPSUM1	0	When this bit is set to 1, it enables an interrupt when the sum of all phase powers in the CF1 datapath changes sign.
10	REVRPA	0	When this bit is set to 1, it enables an interrupt when the Phase A reactive power identified by Bit 7 (REVRPSEL) in the ACCMODE register (total or fundamental) changes sign. Setting this bit to 1 does not have any consequence for the ADE7854A .
11	REVRPB	0	When this bit is set to 1, it enables an interrupt when the Phase B reactive power identified by Bit 7 (REVRPSEL) in the ACCMODE register (total or fundamental) changes sign. Setting this bit to 1 does not have any consequence for the ADE7854A .
12	REVRPC	0	When this bit is set to 1, it enables an interrupt when the Phase C reactive power identified by Bit 7 (REVRPSEL) in the ACCMODE register (total or fundamental) changes sign. Setting this bit to 1 does not have any consequence for the ADE7854A .
13	REVPSUM2	0	When this bit is set to 1, it enables an interrupt when the sum of all phase powers in the CF2 datapath changes sign.
14	CF1		When this bit is set to 1, it enables an interrupt when a high-to-low transition occurs at the CF1 pin, that is, an active low pulse is generated. The interrupt can be enabled even when the CF1 output is disabled by setting Bit 9 (CF1DIS) to 1 in the CFMODE register. The type of power used at the CF1 pin is determined by Bits[2:0] (CF1SEL[2:0]) in the CFMODE register (see Table 42).
15	CF2		When this bit is set to 1, it enables an interrupt when a high to low transition occurs at the CF2 pin; that is, an active low pulse is generated. The interrupt can be enabled even when the CF2 output is disabled by setting Bit 10 (CF2DIS) to 1 in the CFMODE register. The type of power used at the CF2 pin is determined by Bits[5:3] (CF2SEL[2:0]) in the CFMODE register (see Table 42).
16	CF3		When this bit is set to 1, it enables an interrupt when a high to low transition occurs at the CF3 pin; that is, an active low pulse is generated. The interrupt can be enabled even when the CF3 output is disabled by setting Bit 11 (CF3DIS) to 1 in the CFMODE register. The type of power used at the CF3 pin is determined by Bits[8:6] (CF3SEL[2:0]) in the CFMODE register (see Table 42).
17	DREADY	0	When this bit is set to 1, it enables an interrupt when all periodical DSP computations (at an 8 kHz rate) finish.
18	REVPSUM3	0	When this bit is set to 1, it enables an interrupt when the sum of all phase powers in the CF3 datapath changes sign.
[31:19]	Reserved	0000000000000	Reserved. These bits do not manage any functionality.

Table 37. MASK1 Register (Address 0xE50B)

Bits	Bit Name	Default Value	Description
0	NLOAD	0	When this bit is set to 1, it enables an interrupt when at least one phase enters a no load condition based on the total active and reactive powers.
1	FNLOAD	0	When this bit is set to 1, it enables an interrupt when at least one phase enters a no load condition based on the fundamental active and reactive powers. Setting this bit to 1 does not have any consequence for the ADE7854A , ADE7858A , or ADE7868A .
2	VANLOAD	0	When this bit is set to 1, it enables an interrupt when at least one phase enters a no load condition based on apparent power.
3	ZXTOVA	0	When this bit is set to 1, it enables an interrupt when a zero crossing on Phase A voltage is missing.
4	ZXTOVB	0	When this bit is set to 1, it enables an interrupt when a zero crossing on Phase B voltage is missing.
5	ZXTOVC	0	When this bit is set to 1, it enables an interrupt when a zero crossing on Phase C voltage is missing.
6	ZXTOIA	0	When this bit is set to 1, it enables an interrupt when a zero crossing on Phase A current is missing.
7	ZXTOIB	0	When this bit is set to 1, it enables an interrupt when a zero crossing on Phase B current is missing.
8	ZXTOIC	0	When this bit is set to 1, it enables an interrupt when a zero crossing on Phase C current is missing.
9	ZXVA	0	When this bit is set to 1, it enables an interrupt when a zero crossing is detected on Phase A voltage.
10	ZXVB	0	When this bit is set to 1, it enables an interrupt when a zero crossing is detected on Phase B voltage.
11	ZXVC	0	When this bit is set to 1, it enables an interrupt when a zero crossing is detected on Phase C voltage.
12	ZXIA	0	When this bit is set to 1, it enables an interrupt when a zero crossing is detected on Phase A current.
13	ZXIB	0	When this bit is set to 1, it enables an interrupt when a zero crossing is detected on Phase B current.
14	ZXIC	0	When this bit is set to 1, it enables an interrupt when a zero crossing is detected on Phase C current.
15	RSTDONE	0	Because the RSTDONE interrupt cannot be disabled, this bit has no functionality. It can be set to 1 or cleared to 0 without having any effect.
16	Sag	0	When this bit is set to 1, it enables an interrupt when a sag event occurs on one of the phases indicated by Bits[14:12] (VSPHASE[x]) in the PHSTATUS register (see Table 38).
17	OI	0	When this bit is set to 1, it enables an interrupt when an overcurrent event occurs on one of the phases indicated by Bits[5:3] (OIPHASE[x]) in the PHSTATUS register (see Table 38).
18	OV	0	When this bit is set to 1, it enables an interrupt when an overvoltage event occurs on one of the phases indicated by Bits[11:9] (OVPHASE[x]) in the PHSTATUS register (see Table 38).
19	SEQERR	0	When this bit is set to 1, it enables an interrupt when a negative-to-positive zero crossing on Phase A voltage is not followed by a negative to positive zero crossing on Phase B voltage; instead, the zero crossing occurred on the Phase C voltage.
20	MISMTC	0	When this bit is set to 1, it enables an interrupt when $ ISUM - INWV > ISUMLVL$ is greater than the value indicated in the ISUMLVL register. Setting this bit to 1 does not have any consequence for the ADE7854A or ADE7858A .
22:21	Reserved	00	Reserved. These bits do not manage any functionality.
23	PKI	0	When this bit is set to 1, it enables an interrupt when the period used to detect the peak value in the current channel has ended.
24	PKV	0	When this bit is set to 1, it enables an interrupt when the period used to detect the peak value in the voltage channel has ended.
25	CRC	0	When this bit is set to 1, it enables an interrupt when the value of the CHECKSUM register has changed.
[31:26]	Reserved	000000	Reserved. These bits do not manage any functionality.

Table 38. PHSTATUS Register (Address 0xE600)

Bits	Bit Name	Default Value	Description
[2:0]	Reserved	000	Reserved. These bits are always set to 0.
3	OIPHASE[0]	0	When this bit is set to 1, Phase A current generates Bit 17 (OI) in the STATUS1 register.
4	OIPHASE[1]	0	When this bit is set to 1, Phase B current generates Bit 17 (OI) in the STATUS1 register.
5	OIPHASE[2]	0	When this bit is set to 1, Phase C current generates Bit 17 (OI) in the STATUS1 register.
[8:6]	Reserved	000	Reserved. These bits are always set to 0.
9	OVPHASE[0]	0	When this bit is set to 1, Phase A voltage generates Bit 18 (OV) in the STATUS1 register.
10	OVPHASE[1]	0	When this bit is set to 1, Phase B voltage generates Bit 18 (OV) in the STATUS1 register.
11	OVPHASE[2]	0	When this bit is set to 1, Phase C voltage generates Bit 18 (OV) in the STATUS1 register.
12	VSPHASE[0]	0	When this bit is set to 1, Phase A voltage generates Bit 16 (sag) in the STATUS1 register.
13	VSPHASE[1]	0	When this bit is set to 1, Phase B voltage generates Bit 16 (sag) in the STATUS1 register.
14	VSPHASE[2]	0	When this bit is set to 1, Phase C voltage generates Bit 16 (sag) in the STATUS1 register.
15	Reserved	0	Reserved. This bit is always set to 0.

Table 39. PHNOLOAD Register (Address 0xE608)

Bits	Bit Name	Default Value	Description
0	NLPHASE[0]	0	0: Phase A is out of no load condition based on total active/reactive powers. 1: Phase A is in no load condition based on total active/reactive powers. The NLPHASE[0] bit is set together with Bit 0 (NLOAD) in the STATUS1 register. The ADE7854A no load condition is based on the total active powers only.
1	NLPHASE[1]	0	0: Phase B is out of no load condition based on total active/reactive powers. 1: Phase B is in no load condition based on total active/reactive powers. The NLPHASE[1] bit is set together with Bit 0 (NLOAD) in the STATUS1 register. The ADE7854A no load condition is based only on the total active powers.
2	NLPHASE[2]	0	0: Phase C is out of no load condition based on total active/reactive powers. 1: Phase C is in no load condition based on total active/reactive powers. The NLPHASE[1] bit is set together with Bit 0 (NLOAD) in the STATUS1 register. The ADE7854A no load condition is based only on the total active powers.
3	FNLPHASE[0]	0	0: Phase A is out of no load condition based on fundamental active/reactive powers. The FNLPHASE[0] bit is always set to 0 for the ADE7854A , ADE7858A , and ADE7868A . 1: Phase A is in no load condition based on fundamental active/reactive powers. The FNLPHASE[0] bit is set together with Bit 1 (FNLOAD) in STATUS1.
4	FNLPHASE[1]	0	0: Phase B is out of no load condition based on fundamental active/reactive powers. The FNLPHASE[2] bit is always set to 0 for the ADE7854A , ADE7858A , and ADE7868A . 1: Phase B is in no load condition based on fundamental active/reactive powers. The FNLPHASE[1] bit is set together with Bit 1 (FNLOAD) in STATUS1.
5	FNLPHASE[2]	0	0: Phase C is out of no load condition based on fundamental active/reactive powers. The FNLPHASE[2] bit is always set to 0 for the ADE7854A , ADE7858A , and ADE7868A . 1: Phase C is in no load condition based on fundamental active/reactive powers. The FNLPHASE[2] bit is set together with Bit 1 (FNLOAD) in the STATUS1 register.
6	VANLPHASE[0]	0	0: Phase A is out of no load condition based on apparent power. 1: Phase A is in no load condition based on apparent power. The VANLPHASE[0] bit is set together with Bit 2 (VANLOAD) in the STATUS1 register.
7	VANLPHASE[1]	0	0: Phase B is out of no load condition based on apparent power. 1: Phase B is in no load condition based on apparent power. The VANLPHASE[1] bit is set together with Bit 2 (VANLOAD) in the STATUS1 register.
8	VANLPHASE[2]	0	0: Phase C is out of no load condition based on apparent power. 1: Phase C is in no load condition based on apparent power. The VANLPHASE[2] bit is set together with Bit 2 (VANLOAD) in the STATUS1 register.
[15:9]	Reserved	0000000	Reserved. These bits are always set to 0.

Table 40. COMPMODE Register (Address 0xE60E)

Bits	Bit Name	Default Value	Description
0	TERMSEL1[0]	1	Setting all TERMSEL1[2:0] bits to 1 signifies that the sum of all three phases is included in the CF1 output. Phase A is included in the CF1 output calculations.
1	TERMSEL1[1]	1	Phase B is included in the CF1 output calculations.
2	TERMSEL1[2]	1	Phase C is included in the CF1 output calculations.
3	TERMSEL2[0]	1	Setting all TERMSEL2[2:0] bits to 1 signifies that the sum of all three phases is included in the CF2 output. Phase A is included in the CF2 output calculations.
4	TERMSEL2[1]	1	Phase B is included in the CF2 output calculations.
5	TERMSEL2[2]	1	Phase C is included in the CF2 output calculations.
6	TERMSEL3[0]	1	Setting all TERMSEL3[2:0] bits to 1 signifies that the sum of all three phases is included in the CF3 output. Phase A is included in the CF3 output calculations.
7	TERMSEL3[1]	1	Phase B is included in the CF3 output calculations.
8	TERMSEL3[2]	1	Phase C is included in the CF3 output calculations.
[10:9]	ANGLESEL[1:0]	00	00: the angles between phase voltages and phase currents are measured. 01: the angles between phase voltages are measured. 10: the angles between phase currents are measured. 11: no angles are measured.
11	VNOMAEN	0	When this bit is 0, the apparent power on Phase A is computed in a normal manner. When this bit is 1, the apparent power on Phase A is computed using VNOM register instead of regular measured rms phase voltage. The applied Phase A voltage input is ignored, and all Phase A rms voltage instances are replaced by the value in the VNOM register.
12	VNOMBEN	0	When this bit is 0, the apparent power on Phase B is computed in a normal manner. When this bit is 1, the apparent power on Phase B is computed using VNOM register instead of regular measured rms phase voltage. The applied Phase B voltage input is ignored, and all Phase B rms voltage instances are replaced by the value in the VNOM register.
13	VNOMCEN	0	When this bit is 0, the apparent power on Phase C is computed in a normal manner. When this bit is 1, the apparent power on Phase C is computed using VNOM register instead of regular measured rms phase voltage. The applied Phase C voltage input is ignored, and all Phase C rms voltage instances are replaced by the value in the VNOM register.
14	SELFREQ	0	When the ADE7878A is connected to 50 Hz networks, clear this bit to 0 (default value). When the ADE7878A is connected to 60 Hz networks, set this bit to 1. This bit does not have any consequence for the ADE7854A , ADE7858A , or ADE7868A .
15	Reserved	0	This bit is 0 by default and it does not manage any functionality.

Table 41. Gain Register (Address 0xE60F)

Bits	Bit Name	Default Value	Description
[2:0]	PGA1[2:0]	000	Phase currents gain selection. 000: gain = 1. 001: gain = 2. 010: gain = 4. 011: gain = 8. 100: gain = 16. 101, 110, 111: reserved. When set, the ADE7854A/ADE7858A/ADE7868A/ADE7878A behave like PGA1[2:0] = 000.
[5:3]	PGA2[2:0]	000	Neutral current gain selection. 000: gain = 1. These bits are always set to 000 for the ADE7854A and ADE7858A . 001: gain = 2. 010: gain = 4. 011: gain = 8. 100: gain = 16. 101, 110, 111: reserved. When set, the ADE7868A and ADE7878A behave like PGA2[2:0] = 000.

Bits	Bit Name	Default Value	Description
[8:6]	PGA3[2:0]	000	Phase voltages gain selection. 000: gain = 1. 001: gain = 2. 010: gain = 4. 011: gain = 8. 100: gain = 16. 101, 110, 111: reserved. When set, the ADE7854A/ADE7858A/ADE7868A/ADE7878A behave like PGA3[2:0] = 000.
[15:9]	Reserved	0000000	Reserved. These bits do not manage any functionality.

Table 42. CFMODE Register (Address 0xE610)

Bits	Bit Name	Default Value	Description
[2:0]	CF1SEL[2:0]	000	000: the CF1 frequency is proportional to the sum of total active powers on each phase identified by Bits[2:0] (TERMSEL1[x]) in the COMPMODE register. 001: the CF1 frequency is proportional to the sum of total reactive powers on each phase identified by Bits[2:0] (TERMSEL1[x]) in the COMPMODE register. This condition does not have any consequence for the ADE7854A . 010: the CF1 frequency is proportional to the sum of apparent powers on each phase identified by Bits[2:0] (TERMSEL1[x]) in the COMPMODE register. 011: the CF1 frequency is proportional to the sum of fundamental active powers on each phase identified by Bits[2:0] (TERMSEL1[x]) in the COMPMODE register. This condition does not have any consequence for the ADE7854A , ADE7858A , and ADE7868A . 100: the CF1 frequency is proportional to the sum of fundamental reactive powers on each phase identified by Bits[2:0] (TERMSEL1[x]) in the COMPMODE register. This condition does not have any consequence for the ADE7854A , ADE7858A , and ADE7868A . 101, 110, 111: reserved. When set, the CF1 signal is not generated.
[5:3]	CF2SEL[2:0]	001	000: the CF2 frequency is proportional to the sum of total active powers on each phase identified by Bits[5:3] (TERMSEL2[x]) in the COMPMODE register. 001: the CF2 frequency is proportional to the sum of total reactive powers on each phase identified by Bits[5:3] (TERMSEL2[x]) in the COMPMODE register. This condition does not have any consequence for the ADE7854A . 010: the CF2 frequency is proportional to the sum of apparent powers on each phase identified by Bits[5:3] (TERMSEL2[x]) in the COMPMODE register. 011: the CF2 frequency is proportional to the sum of fundamental active powers on each phase identified by Bits[5:3] (TERMSEL2[x]) in the COMPMODE register. This condition does not have any consequence for the ADE7854A , ADE7858A , or ADE7868A . 100: the CF2 frequency is proportional to the sum of fundamental reactive powers on each phase identified by Bits[5:3] (TERMSEL2[x]) in the COMPMODE register. This condition does not have any consequence for the ADE7854A , ADE7858A , or ADE7868A . 101,110,111: reserved. When set, the CF2 signal is not generated.
[8:6]	CF3SEL[2:0]	010	000: the CF3 frequency is proportional to the sum of total active powers on each phase identified by Bits[8:6] (TERMSEL3[x]) in the COMPMODE register. 001: the CF3 frequency is proportional to the sum of total reactive powers on each phase identified by Bits[8:6] (TERMSEL3[x]) in the COMPMODE register. This condition does not have any consequence for the ADE7854A . 010: the CF3 frequency is proportional to the sum of apparent powers on each phase identified by Bits[8:6] (TERMSEL3[x]) in the COMPMODE register. 011: CF3 frequency is proportional to the sum of fundamental active powers on each phase identified by Bits[8:6] (TERMSEL3[x]) in the COMPMODE register. This condition does not have any consequence for the ADE7854A , ADE7858A , or ADE7868A . 100: CF3 frequency is proportional to the sum of fundamental reactive powers on each phase identified by Bits[8:6] (TERMSEL3[x]) in the COMPMODE register. This condition does not have any consequence for the ADE7854A , ADE7858A , or ADE7868A . 101,110,111: reserved. When set, the CF3 signal is not generated.
9	CF1DIS	1	Setting this bit to 1 disables the CF1 output. The respective digital to frequency converter remains enabled even when CF1DIS = 1. Setting this bit to 0 enables the CF1 output.

Bits	Bit Name	Default Value	Description
10	CF2DIS	1	Setting this bit to 1 disables the CF2 output. The respective digital to frequency converter remains enabled even when CF2DIS = 1. Setting this bit to 0 enables the CF2 output.
11	CF3DIS	1	Setting this bit to 1 disables the CF3 output. The respective digital to frequency converter remains enabled even when CF3DIS = 1. Setting this bit to 0 enables the CF3 output.
12	CF1LATCH	0	When this bit is set to 1, the content of the corresponding energy registers is latched when a CF1 pulse is generated. See the Synchronizing Energy Registers with the CFx Outputs section.
13	CF2LATCH	0	When this bit is set to 1, the content of the corresponding energy registers is latched when a CF2 pulse is generated. See the Synchronizing Energy Registers with the CFx Outputs section.
14	CF3LATCH	0	When this bit is set to 1, the content of the corresponding energy registers is latched when a CF3 pulse is generated. See the Synchronizing Energy Registers with the CFx Outputs section.
15	Reserved	0	Reserved. This bit does not manage any functionality.

Table 43. APHCAL, BPHCAL, CPHCAL Registers (Address 0xE614, Address 0xE615, Address 0xE616)

Bits	Bit Name	Default Value	Description
[9:0]	PHCALVAL	000000000	When the current leads the voltage, these bits can vary between 0 and 383 only. When the current lags the voltage, these bits can vary between 512 and 575 only. When the PHCALVAL bits are set with numbers between 384 and 511, the compensation behaves similar to PHCALVAL set between 256 and 383. When the PHCALVAL bits are set with numbers between 576 and 1023, the compensation behaves similar to PHCALVAL bits set between 384 and 511.
[15:10]	Reserved	000000	Reserved. These bits do not manage any functionality.

Table 44. PHSIGN Register (Address 0xE617)

Bits	Bit Name	Default Value	Description
0	AWSIGN	0	0: if the active power identified by Bit 6 (REVAPSEL) in the ACCMODE register (total of fundamental) on Phase A is positive. 1: if the active power identified by Bit 6 (REVAPSEL) in the ACCMODE register (total of fundamental) on Phase A is negative.
1	BWSIGN	0	0: if the active power identified by Bit 6 (REVAPSEL) in the ACCMODE register (total of fundamental) on Phase B is positive. 1: if the active power identified by Bit 6 (REVAPSEL) in the ACCMODE register (total of fundamental) on Phase B is negative.
2	CWSIGN	0	0: if the active power identified by Bit 6 (REVAPSEL) in the ACCMODE register (total of fundamental) on Phase C is positive. 1: if the active power identified by Bit 6 (REVAPSEL) in the ACCMODE register (total of fundamental) on Phase C is negative.
3	SUM1SIGN	0	0: if the sum of all phase powers in the CF1 datapath is positive. 1: if the sum of all phase powers in the CF1 datapath is negative. Phase powers in the CF1 datapath are identified by Bits[2:0] (TERMSEL1[x]) of the COMPMODE register and by Bits[2:0] (CF1SEL[x]) of the CFMODE register.
4	AVARSIGN	0	0: when the reactive power identified by Bit 7 (REVRPSEL) in the ACCMODE register (total of fundamental) on Phase A is positive. This bit is always set to 0 for the ADE7854A . 1: when the reactive power identified by Bit 7 (REVRPSEL) in the ACCMODE register (total of fundamental) on Phase A is negative.
5	BVARSIGN	0	0: when the reactive power identified by Bit 7 (REVRPSEL) in the ACCMODE register (total of fundamental) on Phase B is positive. This bit is always set to 0 for the ADE7854A . 1: when the reactive power identified by Bit 7 (REVRPSEL) in the ACCMODE register (total of fundamental) on Phase B is negative.
6	CVARSIGN	0	0: if the reactive power identified by Bit 7 (REVRPSEL) in the ACCMODE register (total of fundamental) on Phase C is positive. This bit is always set to 0 for the ADE7854A . 1: if the reactive power identified by Bit 7 (REVRPSEL) in the ACCMODE register (total of fundamental) on Phase C is negative.

Bits	Bit Name	Default Value	Description
7	SUM2SIGN	0	0: if the sum of all phase powers in the CF2 datapath is positive. 1: if the sum of all phase powers in the CF2 datapath is negative. Phase powers in the CF2 datapath are identified by Bits[5:3] (TERMSEL2[x]) of the COMPMODE register and by Bits[5:3] (CF2SEL[x]) of the CFMODE register.
8	SUM3SIGN	0	0: if the sum of all phase powers in the CF3 datapath is positive. 1: if the sum of all phase powers in the CF3 datapath is negative. Phase powers in the CF3 datapath are identified by Bits[8:6] (TERMSEL3[x]) of the COMPMODE register and by Bits[8:6] (CF3SEL[x]) of the CFMODE register.
[15:9]	Reserved	0000000	Reserved. These bits are always set to 0.

Table 45. CONFIG Register (Address 0xE618)

Bits	Bit Name	Default Value	Description
0	INTEN	0	Integrator enable. When this bit is set to 1, INTEN enables the internal digital integrator for use in meters employing Rogowski coils on all 3-phase and neutral current inputs. When this bit is cleared to 0, the internal digital integrator is disabled.
[2:1]	Reserved	00	Reserved. These bits do not manage any functionality.
3	SWAP	0	Setting this bit to 1 swaps the voltage channel outputs with the current channel outputs. Thus, the current channel information is present in the voltage channel registers and vice versa.
4	MOD1SHORT	0	When this bit is set to 1, the voltage channel ADCs behave as if the voltage channel inputs were grounded.
5	MOD2SHORT	0	When this bit is set to 1, the current channel ADCs behave as if the current channel inputs were grounded.
6	HSDCEN	0	Setting this bit to 1 enables the HSDC serial port, and the HSCLK functionality is chosen at the CF3/HSCLK pin. Clearing this bit to 0 disables HSDC, and the CF3 functionality is chosen at CF3/HSCLK pin.
7	SWRST	0	Setting this bit to 1 initiates a software reset.
[9:8]	VTOIA[1:0]	00	These bits determine the phase voltage together with Phase A current in the power path. 00: Phase A voltage. 01: Phase B voltage. 10: Phase C voltage. 11: reserved. When set, the ADE7854A/ADE7858A/ADE7868A/ADE7878A mimic the behavior of VTOIA[1:0] = 00.
[11:10]	VTOIB[1:0]	00	These bits determine the phase voltage together with Phase B current in the power path. 00: Phase B voltage. 01: Phase C voltage. 10: Phase A voltage. 11: reserved. When set, the ADE7854A/ADE7858A/ADE7868A/ADE7878A mimic the behavior of VTOIB[1:0] = 00.
[13:12]	VTOIC[1:0]	00	These bits determine the phase voltage together with Phase C current in the power path. 00: Phase C voltage. 01: Phase A voltage. 10: Phase B voltage. 11: reserved. When set, the ADE7854A/ADE7858A/ADE7868A/ADE7878A mimic the behavior of VTOIC[1:0] = 00.
[15:14]	Reserved	0	Reserved. These bits do not manage any functionality.

Table 46. CONFIG_A Register (Address 0xE740)

Bits	Bit Name	Default Value	Description
0	INSEL	0	When INSEL[0] = 0, the NIRMS register contains the rms value of the neutral current. When INSEL[0] = 1, the NIRMS register contains the rms value of ISUM, the instantaneous value of the sum of all 3-phase currents, IA, IB, and IC.
1	LPFSEL	0	Setting this bit to 1 subjects the total active and reactive power measurement to increased filtering.
[2:7]	Reserved	0	Reserved. These bits do not manage any functionality.

Table 47. MMODE Register (Address 0xE700)

Bits	Bit Name	Default Value	Description
[1:0]	PERSEL[1:0]	00	00: Phase A selected as the source of the voltage line period measurement. 01: Phase B selected as the source of the voltage line period measurement. 10: Phase C selected as the source of the voltage line period measurement. 11: reserved. When set, the ADE7854A/ADE7858A/ADE7868A/ADE7878A mimic the behavior of PERSEL[1:0] = 00.
2	PEAKSEL[0]	1	PEAKSEL[2:0] bits can all be set to 1 simultaneously to allow peak detection on all three phases simultaneously. If more than one PEAKSEL[2:0] bit is set to 1, the peak measurement period indicated in the PEAKCYC register decreases accordingly because zero crossings are detected on more than one phase. Setting this bit to 1 selects Phase A for the voltage and current peak registers.
3	PEAKSEL[1]	1	Setting this bit to 1 selects Phase B for the voltage and current peak registers.
4	PEAKSEL[2]	1	Setting this bit to 1 selects Phase C for the voltage and current peak registers.
[7:5]	Reserved	000	Reserved. These bits do not manage any functionality.

Table 48. ACCMODE Register (Address 0xE701)

Bits	Bit Name	Default Value	Description
[1:0]	WATTACC[1:0]	00	00: signed accumulation mode of the total and fundamental active powers. Fundamental active powers are available in the ADE7878A only. 01: reserved. When set, the device mimics the behavior of WATTACC[1:0] = 00. 10: reserved. When set, the device mimics the behavior of WATTACC[1:0] = 00. 11: absolute accumulation mode of the total and fundamental active powers. Fundamental active powers are available in the ADE7878A only. This mode is observed only in the CFx output. The accumulation in the registers continues to be a signed accumulation as in the case of WATTACC[1:0] being set to 00.
[3:2]	VARACC[1:0]	00	00: signed accumulation of the total and fundamental reactive powers. Total reactive powers are available in the ADE7858A , ADE7868A , and ADE7878A . Fundamental reactive powers are available in the ADE7878A only. These bits are always set to 00 for the ADE7854A . 01: reserved. When set, the device mimics the behavior of VARACC[1:0] = 00. 10: the total and fundamental reactive powers are accumulated, depending on the sign of the total and fundamental active power. When the active power is positive, the reactive power accumulates as it is; when the active power is negative, the reactive power accumulates with the reversed sign. This mode is observed only in the CFx output. The accumulation in the registers continues to be a signed accumulation as in the case of VARACC[1:0] being set to 00. 11: absolute accumulation mode of the total and fundamental reactive powers. Total reactive powers are available in the ADE7858A , ADE7868A , and ADE7878A . Fundamental reactive powers are available in the ADE7878A only. This mode is observed only in the CFx output. The accumulation in the registers continues to be a signed accumulation as in the case of VARACC[1:0] being set to 00.
[5:4]	CONSEL[1:0]	00	These bits select the inputs to the energy accumulation registers. IA', IB', and IC' are IA, IB, and IC shifted, respectively, by -90°. See Table 49. 00: 3-phase, 4-wire wye with three voltage sensors. 01: 3-phase, 3-wire delta connection. 10: 3-phase, 4-wire wye with two voltage sensors. 11: 3-phase, 4-wire delta connection.
6	REVAPSEL	0	0: the total active power on each phase is used to trigger a bit in the STATUS0 register as follows: on Phase A, triggers Bit 6 (REVAPA); on Phase B, triggers Bit 7 (REVAPB); and on Phase C, triggers Bit 8 (REVAPC). This bit is always set to 0 for the ADE7854A , ADE7858A , and ADE7868A . 1: the fundamental active power on each phase is used to trigger a bit in the STATUS0 register as follows: on Phase A, triggers Bit 6 (REVAPA); on Phase B, triggers Bit 7 (REVAPB); and on Phase C, triggers Bit 8 (REVAPC).
7	REVRPSEL	0	0: the total reactive power on each phase is used to trigger a bit in the STATUS0 register as follows: on Phase A, triggers Bit 10 (REVRPA); on Phase B, triggers Bit 11 (REVRPB); and on Phase C, triggers Bit 12 (REVRPC). This bit is always set to 0 for the ADE7854A , ADE7858A , and ADE7868A . 1: the fundamental reactive power on each phase is used to trigger a bit in the STATUS0 register as follows: on Phase A triggers Bit 10 (REVRPA), on Phase B triggers Bit 11 (REVRPB), and on Phase C triggers Bit 12 (REVRPC).

Table 49. CONSEL[1:0] Bits in Energy Registers

Energy Registers	CONSEL[1:0] = 00	CONSEL[1:0] = 01	CONSEL[1:0] = 10	CONSEL[1:0] = 11
AWATTHR, AFWATTHR	$VA \times IA$	$VA \times IA$	$VA \times IA$	$VA \times IA$
BWATTHR, BFWATTHR	$VB \times IB$	$VB = VA - VC^1$ $VB \times IB$	$VB = -VA - VC$ $VB \times IB$	$VB = -VA$ $VB \times IB$
CWATTHR, CFWATTHR	$VC \times IC$	$VC \times IC$	$VC \times IC$	$VC \times IC$
AVARHR, AFWARHR	$VA \times IA'$	$VA \times IA'$	$VA \times IA'$	$VA \times IA'$
BVARHR, BFWARHR	$VB \times IB'$	$VB = VA - VC^1$ $VB' \times IB$	$VB = -VA - VC$ $VB \times IB'$	$VB = -VA$ $VB \times IB'$
CVARHR, CFVARHR	$VC \times IC'$	$VC \times IC'$	$VC \times IC'$	$VC \times IC'$
AVAHR	$VA \text{ rms} \times IA \text{ rms}$	$VA \text{ rms} \times IA \text{ rms}$	$VA \text{ rms} \times IA \text{ rms}$	$VA \text{ rms} \times IA \text{ rms}$
BVAHR	$VB \text{ rms} \times IB \text{ rms}$	$VB \text{ rms} \times IB \text{ rms}$	$VB \text{ rms} \times IB \text{ rms}$	$VB \text{ rms} \times IB \text{ rms}$
		$VB = VA - VC^1$	$VB = -VA - VC$	$VB = -VA$
CVAHR	$VC \text{ rms} \times IC \text{ rms}$	$VC \text{ rms} \times IC \text{ rms}$	$VC \text{ rms} \times IC \text{ rms}$	$VC \text{ rms} \times IC \text{ rms}$

¹ In a 3-phase, 3-wire case (CONSEL[1:0] = 01), the device computes the rms value of the line voltage between Phase A and Phase C and stores the result into the BVRMS register (see the Voltage RMS in 3-Phase, 3-Wire Delta Configurations section). Consequently, the device computes powers associated with Phase B that do not have physical meaning. To avoid any errors in the frequency output pins (CF1, CF2, or CF3) related to the powers associated with Phase B, disable the contribution of Phase B to the energy to frequency converters by setting Bit TERMSEL1[1], Bit TERMSEL2[1], or Bit TERMSEL3[1] to 0 in the COMPMODE register (see the Energy to Frequency Conversion section).

Table 50. LCYCMODE Register (Address 0xE702)

Bits	Bit Name	Default Value	Description
0	LWATT	0	0: places the watt-hour accumulation registers (AWATTHR, BWATTHR, CWATTHR, AFWATTHR, BFWATTHR, and CFWATTHR) into regular accumulation mode. 1: places the watt-hour accumulation registers (AWATTHR, BWATTHR, CWATTHR, AFWATTHR, BFWATTHR, and CFWATTHR) into line cycle accumulation mode.
1	LVAR	0	0: places the var-hour accumulation registers (AVARHR, BVARHR, and CVARHR) into regular accumulation mode. This bit is always set to 0 for the ADE7854A. 1: places the var-hour accumulation registers (AVARHR, BVARHR, and CVARHR) into line cycle accumulation mode.
2	LVA	0	0: places the VA-hour accumulation registers (AVAHR, BVAHR, and CVAHR) into regular accumulation mode. 1: places the VA-hour accumulation registers (AVAHR, BVAHR, and CVAHR) into line cycle accumulation mode.
3	ZXSEL[0]	1	0: Phase A is not selected for zero-crossing counts in the line cycle accumulation mode. 1: Phase A is selected for zero-crossing counts in the line cycle accumulation mode. The accumulation time is shortened accordingly when more than one phase is selected for zero-crossing detection.
4	ZXSEL[1]	1	0: Phase B is not selected for zero-crossing counts in the line cycle accumulation mode. 1: Phase B is selected for zero-crossing counts in the line cycle accumulation mode.
5	ZXSEL[2]	1	0: Phase C is not selected for zero-crossing counts in the line cycle accumulation mode. 1: Phase C is selected for zero-crossing counts in the line cycle accumulation mode.
6	RSTREAD	1	0: disables read with reset of all energy registers. Clear this bit to 0 when Bits[2:0] (LWATT, LVAR, and LVA) are set to 1. 1: enables read with reset of all xWATTHR, xVARHR, xVAHR, xFWATTHR, and xFVARHR registers. This means that a read of those registers resets them to 0.
7	Reserved	0	Reserved. This bit does not manage any functionality.

Table 51. HSDC_CFG Register (Address 0xE706)

Bits	Bit Name	Default Value	Description
0	HCLK	0	0: HSCLK is 8 MHz. 1: HSCLK is 4 MHz.
1	HSIZE	0	0: HSDC transmits the 32-bit registers in 32-bit packages, MSB first. 1: HSDC transmits the 32-bit registers in 8-bit packages, MSB first.
2	HGAP	0	0: no gap is introduced between packages. 1: introduces a gap of seven HCLK cycles between packages.
[4:3]	HXFER[1:0]	00	00 = for the ADE7854A , HSDC transmits sixteen 32-bit words in the following order: IAWV, VAWV, IBWV, VBWV, ICWV, and VCWV; one 32-bit word equal to 0, AVA, BVA, CVA, AWATT, BWATT, and CWATT; and three 32-bit words equal to 0. For the ADE7858A , HSDC transmits sixteen 32-bit words in the following order: IAWV, VAWV, IBWV, VBWV, ICWV, and VCWV and one 32-bit word equal to 0, AVA, BVA, CVA, AWATT, BWATT, CWATT, AVAR, BVAR, and CVAR. For the ADE7868A and ADE7878A , HSDC transmits sixteen 32-bit words in the following order: IAWV, VAWV, IBWV, VBWV, ICWV, VCWV, INWV, AVA, BVA, CVA, AWATT, BWATT, CWATT, AVAR, BVAR, and CVAR. 01 = for the ADE7854A and ADE7858A , HSDC transmits six instantaneous values of currents and voltages in the following order: IAWV, VAWV, IBWV, VBWV, ICWV, and VCWV, and one 32-bit word equal to 0. For the ADE7868A and ADE7878A , HSDC transmits seven instantaneous values of currents and voltages in the following order: IAWV, VAWV, IBWV, VBWV, ICWV, VCWV, and INWV. 10 = for the ADE7854A , HSDC transmits six instantaneous values of phase powers in the following order: AVA, BVA, CVA, AWATT, BWATT, and CWATT and three 32-bit words equal to 0. For the ADE7858A , ADE7868A , and ADE7878A , HSDC transmits nine instantaneous values of phase powers in the following order: AVA, BVA, CVA, AWATT, BWATT, CWATT, AVAR, BVAR, and CVAR. 11 = reserved. If set, the ADE7854A , ADE7858A , ADE7868A , and ADE7878A behave as if HXFER[1:0] = 00.
5	HSAPOL	0	0: \overline{SS} /HSA output pin is active low. 1: \overline{SS} /HSA output pin is active high.
[7:6]	Reserved	00	Reserved. These bits do not manage any functionality.

Table 52. LPOILVL Register (Address 0xEC00)¹

Bits	Bit Name	Default Value	Description
[2:0]	LPOIL[2:0]	000	PSM2 threshold selection; see Table 10.
[7:3]	LPLINE[4:0]	00000	For PSM2 interrupt mode, the measurement period is $0.02 \times (LPLINE + 10)$ seconds. For PSM2 IRQ1 only mode, the measurement period is $0.02 \times (LPLINE + 1)$; use an external timer to wait for this period.

¹ The LPOILVL register is available for the [ADE7868A](#) and [ADE7878A](#) only; it is reserved for the [ADE7854A](#) and [ADE7858A](#).

Table 53. CONFIG2 Register (Address 0xEC01)

Bits	Bit Name	Default Value	Description
0	EXTREFEN	0	Setting this bit to 0 signifies that the internal voltage reference is used in the ADCs. Setting this bit is set to 1 connects an external reference to Pin 17, REF _{IN/OUT} .
1	I2C_LOCK	0	Setting this bit is set to 0 allows the \overline{SS} /HSA pin to be toggled three times to activate the SPI port. When I ² C is the active serial port, this bit must be set to 1 to lock it in. From this moment on, spurious toggling of the \overline{SS} /HSA pin and an eventual switch to using the SPI port is no longer possible. When SPI is the active serial port, any write to the CONFIG2 register locks the port. From this moment on, switching to the I ² C port is no longer possible. Once locked, the serial port choice is maintained when the PSMx power modes of the ADE7854A , ADE7858A , ADE7868A , and ADE7878A change.
2	IRQ0_DIS	0	When set to 1, the IRQ0 pin is disabled in PSM2 mode.
[7:3]	Reserved	0	Reserved. These bits do not manage any functionality.

OUTLINE DIMENSIONS

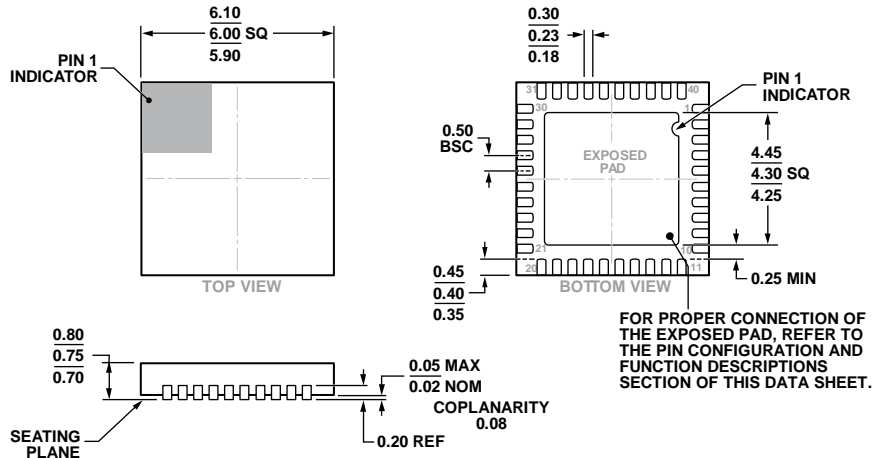

COMPLIANT TO JEDEC STANDARDS MO-220-WJJD.

Figure 104. 40-Lead Lead Frame Chip Scale Package [LFCSP_WQ]
6 mm × 6 mm Body, Very Very Thin Quad
(CP-40-10)
Dimensions shown in millimeters

ORDERING GUIDE

Model ^{1,2}	Temperature Range	Package Description	Package Option
ADE7854AAPZ	-40°C to +85°C	40-Lead LFCSP_WQ	CP-40-10
ADE7854AAPZ-RL	-40°C to +85°C	40-Lead LFCSP_WQ, 13" Tape and Reel	CP-40-10
ADE7858AAPZ	-40°C to +85°C	40-Lead LFCSP_WQ	CP-40-10
ADE7858AAPZ-RL	-40°C to +85°C	40-Lead LFCSP_WQ, 13" Tape and Reel	CP-40-10
ADE7868AAPZ	-40°C to +85°C	40-Lead LFCSP_WQ	CP-40-10
ADE7868AAPZ-RL	-40°C to +85°C	40-Lead LFCSP_WQ, 13" Tape and Reel	CP-40-10
ADE7878AAPZ	-40°C to +85°C	40-Lead LFCSP_WQ	CP-40-10
ADE7878AAPZ-RL	-40°C to +85°C	40-Lead LFCSP_WQ, 13" Tape and Reel	CP-40-10
EVAL-ADE7878AEBZ		Evaluation Board	

¹ Z = RoHS Compliant Part.

² The EVAL-ADE7878AEBZ, an evaluation board built upon the ADE7878A configuration, supports the evaluation of all features for the ADE7854A, ADE7858A, ADE7868A, and ADE7878A devices.

NOTES

I²C refers to a communications protocol originally developed by Philips Semiconductors (now NXP Semiconductors).

©2014 Analog Devices, Inc. All rights reserved. Trademarks and registered trademarks are the property of their respective owners.
D11136-0-10/14(B)



www.analog.com

Компания «Life Electronics» занимается поставками электронных компонентов импортного и отечественного производства от производителей и со складов крупных дистрибьюторов Европы, Америки и Азии.

С конца 2013 года компания активно расширяет линейку поставок компонентов по направлению коаксиальный кабель, кварцевые генераторы и конденсаторы (керамические, пленочные, электролитические), за счёт заключения дистрибьюторских договоров

Мы предлагаем:

- Конкурентоспособные цены и скидки постоянным клиентам.
- Специальные условия для постоянных клиентов.
- Подбор аналогов.
- Поставку компонентов в любых объемах, удовлетворяющих вашим потребностям.
- Приемлемые сроки поставки, возможна ускоренная поставка.
- Доставку товара в любую точку России и стран СНГ.
- Комплексную поставку.
- Работу по проектам и поставку образцов.
- Формирование склада под заказчика.
- Сертификаты соответствия на поставляемую продукцию (по желанию клиента).
- Тестирование поставляемой продукции.
- Поставку компонентов, требующих военную и космическую приемку.
- Входной контроль качества.
- Наличие сертификата ISO.

В составе нашей компании организован Конструкторский отдел, призванный помогать разработчикам, и инженерам.

Конструкторский отдел помогает осуществить:

- Регистрацию проекта у производителя компонентов.
- Техническую поддержку проекта.
- Защиту от снятия компонента с производства.
- Оценку стоимости проекта по компонентам.
- Изготовление тестовой платы монтаж и пусконаладочные работы.



Тел: +7 (812) 336 43 04 (многоканальный)

Email: org@lifeelectronics.ru