

## Automotive-grade 400 V internally clamped IGBT $E_{SCIS}$ 320 mJ

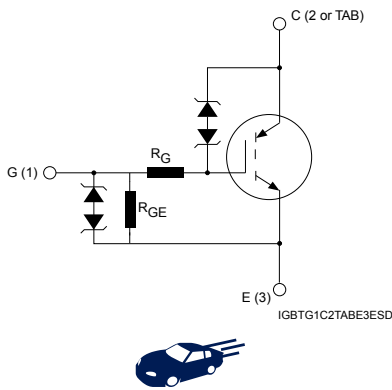
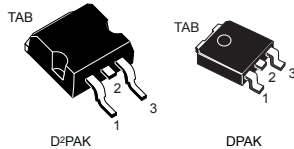

### Features

- AEC-Q101 qualified
- SCIS energy of 320 mJ @  $T_J = 25\text{ }^\circ\text{C}$
- Parts are 100% tested in SCIS
- ESD gate-emitter protection
- Gate-collector high voltage clamping
- Logic level gate drive
- Very low saturation voltage
- High pulsed current capability
- Gate and gate-emitter resistor

### Applications

- Automotive ignition coil driver circuit

### Description

This application-specific IGBT utilizes the most advanced PowerMESH™ technology optimized for coil driving in the harsh environment of automotive ignition systems. These devices show very low on-state voltage and very high SCIS energy capability over a wide operating temperature range. Moreover, ESD-protected logic level gate input and an integrated gate resistor means no external protection circuitry is required.

Product status	
	STGB25N40LZAG
	STGD25N40LZAG
Product summary	
Order code	STGB25N40LZAG
Marking	GB25N40LZ
Package	D²PAK
Packing	Tape and reel
Order code	STGD25N40LZAG
Marking	GD25N40LZ
Package	DPAK
Packing	Tape and reel

# 1 Electrical ratings

**Table 1. Absolute maximum ratings**

Symbol	Parameter	Value	Unit
$V_{CES}$	Collector-emitter voltage ( $V_{GE} = 0\text{ V}$ )	$V_{CES(\text{clamped})}$	V
$V_{ECS}$	Emitter-collector voltage ( $V_{GE} = 0\text{ V}$ )	20	V
$I_C$	Continuous collector current at $T_C = 25\text{ °C}$ , $V_{GE} = 4\text{ V}$	25	A
	Continuous collector current at $T_C = 100\text{ °C}$ , $V_{GE} = 4\text{ V}$	25	A
$I_{CP}^{(1)}$	Pulsed collector current	50	A
$V_{GE}$	Gate-emitter voltage	$V_{GE(\text{clamped})}$	V
$P_{TOT}$	Total dissipation at $T_C = 25\text{ °C}$	150	W
$E_{SCIS\_25}^{(2)}$	Self clamping inductive switching energy	320	mJ
$E_{SCIS\_150}^{(3)}$	Self clamping inductive switching energy @ $T_J = 150\text{ °C}$	180	mJ
ESD	Human body model, $R = 1.5\text{ k}\Omega$ , $C = 100\text{ pF}$	4	kV
	Charged device model	2	kV
$T_{STG}$	Storage temperature range	- 55 to 175	°C
$T_J$	Operating junction temperature range		

1. Pulse width limited by maximum junction temperature.
2. Starting  $T_J = 25\text{ °C}$ ,  $L = 3\text{ mH}$ ,  $R_g = 1\text{ k}\Omega$ ,  $V_{cc} = 50\text{ V}$  during inductor charging and  $V_{cc} = 0\text{ V}$  during the time in clamp. Parts are 100% electrically tested in production.
3. Starting  $T_J = 150\text{ °C}$ ,  $L = 3\text{ mH}$ ,  $R_g = 1\text{ k}\Omega$ ,  $V_{cc} = 50\text{ V}$  during inductor charging and  $V_{cc} = 0\text{ V}$  during the time in clamp.

**Table 2. Thermal data**

Symbol	Parameter	Value		Unit
		D <sup>2</sup> PAK	DPAK	
$R_{thj\text{-case}}$	Thermal resistance junction-case	1		°C/W
$R_{thj\text{-amb}}$	Thermal resistance junction-ambient	62.5	100	°C/W

## 2 Electrical characteristics

$T_C = 25\text{ °C}$  unless otherwise specified

**Table 3. Static characteristics**

Symbol	Parameter	Test conditions	Min.	Typ.	Max.	Unit
$V_{CES(\text{clamped})}$	Collector-emitter clamped voltage	$I_C = 2\text{ mA}, V_{GE} = 0\text{ V}$		400		V
		$I_C = 2\text{ mA}, V_{GE} = 0\text{ V}, T_J = -40\text{ °C to }175\text{ °C}$	375		435	V
$V_{(BR)ECS}$	Emitter-collector break-down voltage	$I_C = 75\text{ mA}, V_{GE} = 0\text{ V}$	20			V
$V_{GE(\text{clamped})}$	Gate-emitter clamped voltage	$I_G = \pm 2\text{ mA}, T_J = -40\text{ °C to }175\text{ °C}$	12		16	V
$V_{CE(\text{sat})}$	Collector-emitter saturation voltage	$V_{GE} = 4\text{ V}, I_C = 6\text{ A}$		1.1	1.25	V
		$V_{GE} = 4.5\text{ V}, I_C = 10\text{ A}, T_J = 175\text{ °C}$		1.25	1.55	V
$V_{GE(\text{th})}$	Gate-threshold voltage	$V_{GE} = V_{CE}, I_C = 1\text{ mA}$	1.3	1.7	2.1	V
		$V_{GE} = V_{CE}, I_C = 1\text{ mA}, T_J = 175\text{ °C}$		1.05		V
$I_{CES}$	Collector cut-off current	$V_{CE} = 15\text{ V}, V_{GE} = 0\text{ V}, T_J = 175\text{ °C}$			20	$\mu\text{A}$
		$V_{CE} = 200\text{ V}, V_{GE} = 0\text{ V}, T_J = 175\text{ °C}$			100	$\mu\text{A}$
$I_{GES}$	Gate-emitter leakage current	$V_{GE} = \pm 10\text{ V}, V_{CE} = 0\text{ V}$		625		$\mu\text{A}$
		$V_{GE} = \pm 10\text{ V}, V_{CE} = 0\text{ V}, T_J = -40\text{ °C to }175\text{ °C}$	450		900	$\mu\text{A}$
$R_{GE}$	Gate emitter resistance		11	16	22	k $\Omega$
$R_G$	Gate resistance			120		$\Omega$

**Table 4. Dynamic characteristics**

Symbol	Parameter	Test conditions	Min.	Typ.	Max.	Unit
$C_{ies}$	Input capacitance	$V_{CE} = 25\text{ V}, f = 1\text{ MHz}, V_{GE} = 0\text{ V}$	-	1011	-	$\mu\text{F}$
$C_{oes}$	Output capacitance		-	87	-	
$C_{res}$	Reverse transfer capacitance		-	14	-	
$Q_g$	Total gate charge	$V_{CE} = 13\text{ V}, I_C = 10\text{ A}, V_{GE} = 0\text{ to }5\text{ V}$	-	26	-	nC

**Table 5. Resistive load switching characteristics**

Symbol	Parameter	Test conditions	Min.	Typ.	Max.	Unit
$t_{d(\text{on})}$	Turn-on delay time	$V_{CC} = 14\text{ V}, V_{GE} = 5\text{ V}, R_L = 1\text{ }\Omega, R_G = 1\text{ k}\Omega$	-	1.1	-	$\mu\text{s}$
$t_r$	Current rise time	(see Figure 17. Test circuit for resistive load switching)	-	3.6	-	$\mu\text{s}$
$t_{d(\text{on})}$	Turn-on delay time	$V_{CC} = 14\text{ V}, V_{GE} = 5\text{ V}, R_L = 1\text{ }\Omega, R_G = 1\text{ k}\Omega, T_J = 150\text{ °C}$	-	1.06	-	$\mu\text{s}$
$t_r$	Current rise time	(see Figure 17. Test circuit for resistive load switching)	-	3.5	-	$\mu\text{s}$

**Table 6. Inductive load switching characteristics**

Symbol	Parameter	Test conditions	Min.	Typ.	Max.	Unit
$t_{d(off)}$	Turn-off delay time	$V_{CC} = 300\text{ V}$ , $L = 1\text{ mH}$ , $I_C = 10\text{ A}$ , $V_{GE} = 5\text{ V}$ , $R_G = 1\text{ k}\Omega$	-	4.6	-	$\mu\text{s}$
$t_f$	Current fall time	(see Figure 16. Test circuit for inductive load switching)	-	8.4	-	$\mu\text{s}$
dV/dt	Turn-off voltage slope	(see Figure 16. Test circuit for inductive load switching)	-	165	-	V/ $\mu\text{s}$
$t_{d(off)}$	Turn-off delay time	$V_{CC} = 300\text{ V}$ , $L = 1\text{ mH}$ , $I_C = 10\text{ A}$ , $V_{GE} = 5\text{ V}$ , $R_G = 1\text{ k}\Omega$ , $T_J = 150\text{ }^\circ\text{C}$	-	4.7	-	$\mu\text{s}$
$t_f$	Current fall time	(see Figure 16. Test circuit for inductive load switching)	-	9.8	-	$\mu\text{s}$
dV/dt	Turn-off voltage slope	(see Figure 16. Test circuit for inductive load switching)	-	122	-	V/ $\mu\text{s}$

## 2.1 Electrical characteristics (curves)

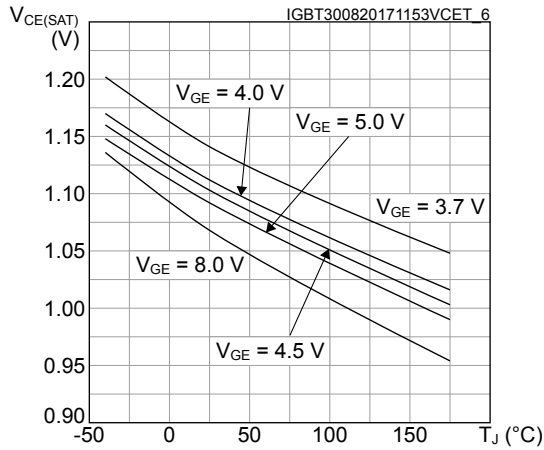
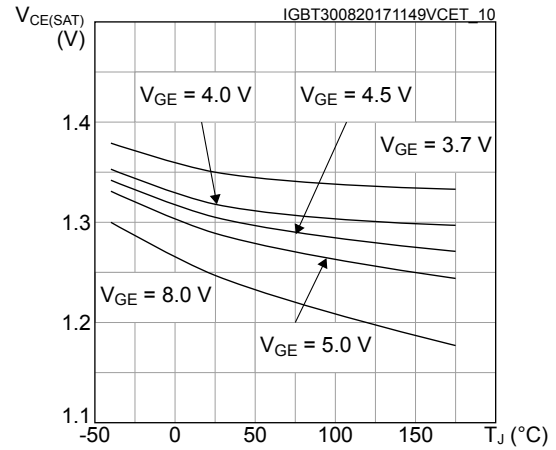
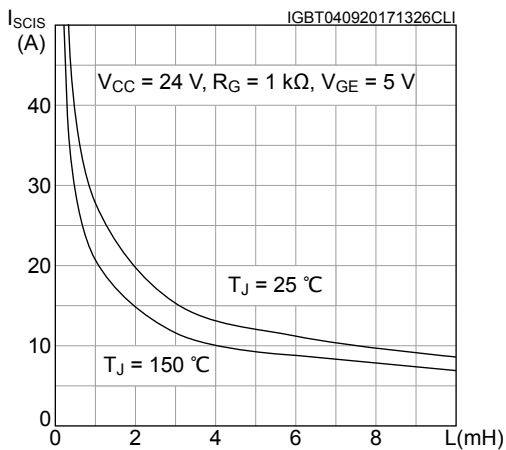
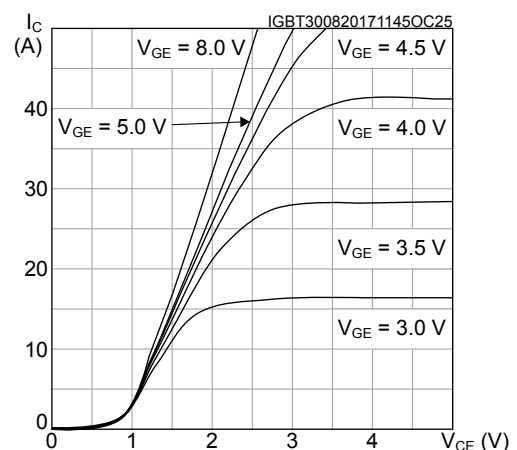
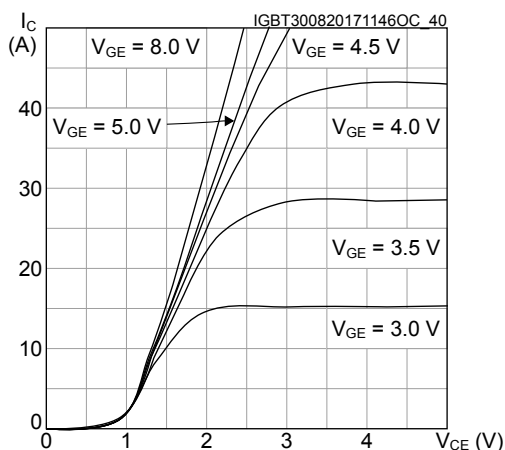
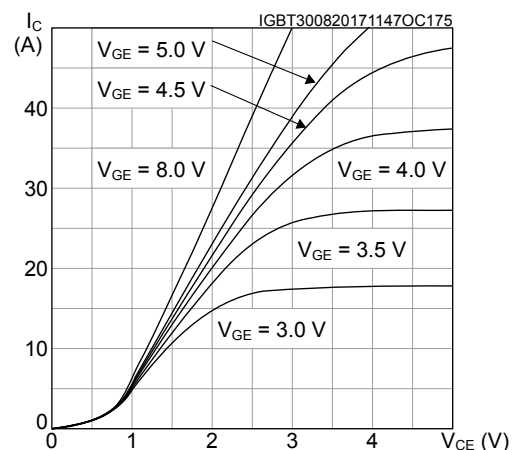
**Figure 1.  $V_{CE(sat)}$  vs. junction temperature ( $I_C = 6\text{ A}$ )**

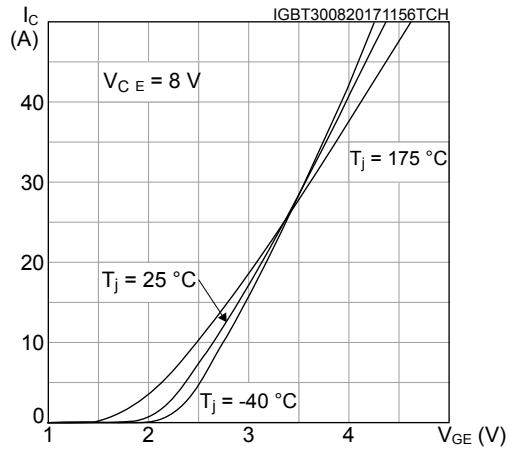
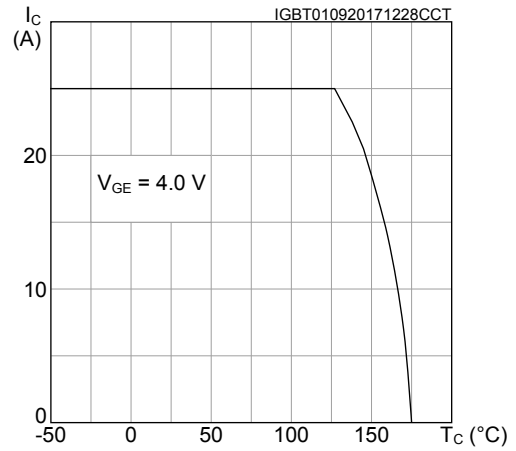
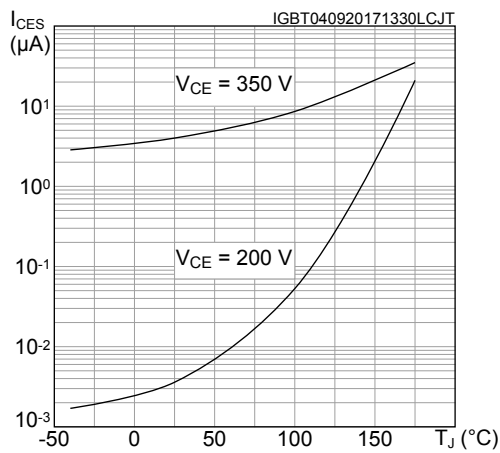
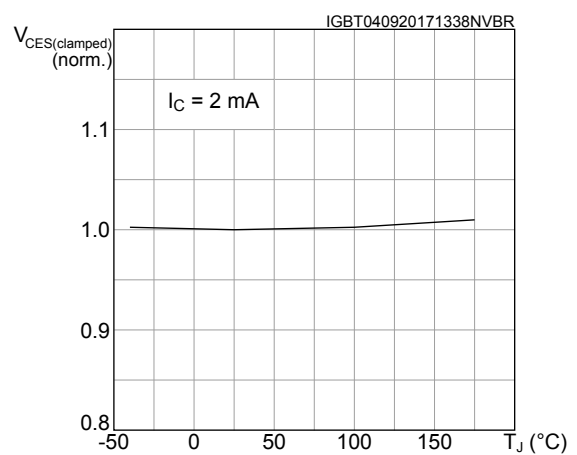
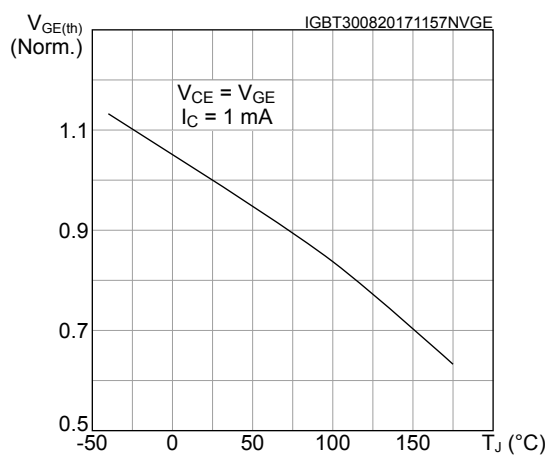
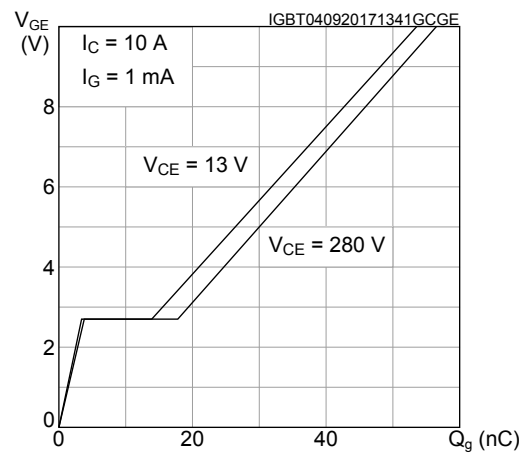
**Figure 2.  $V_{CE(sat)}$  vs. junction temperature ( $I_C = 10\text{ A}$ )**

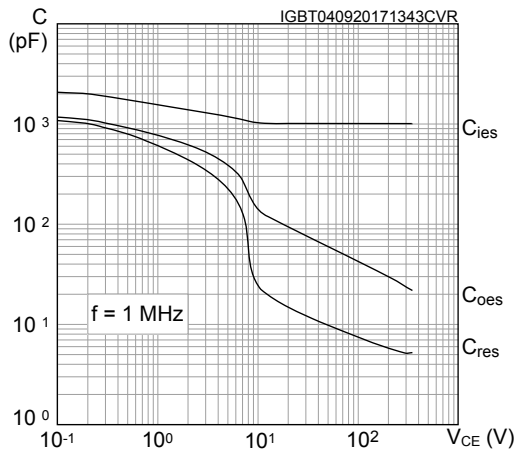
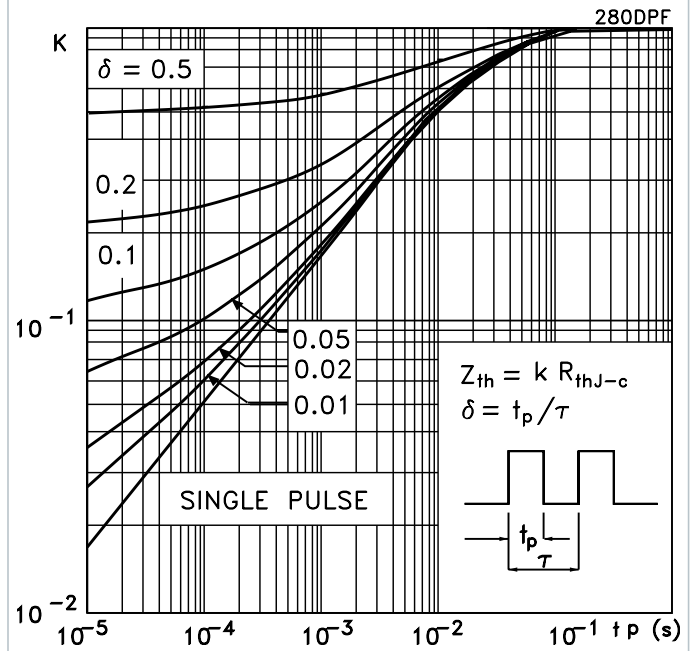
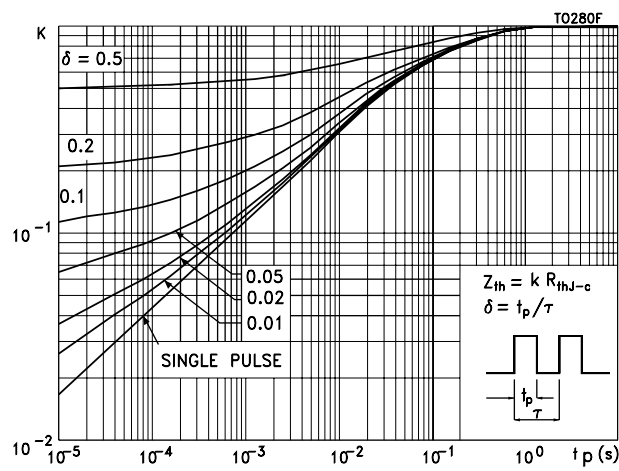
**Figure 3. Self clamped inductive switching current**

**Figure 4. Output characteristics ( $T_J = 25\text{ }^\circ\text{C}$ )**

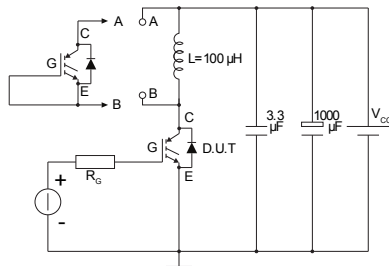
**Figure 5. Output characteristics ( $T_J = -40\text{ }^\circ\text{C}$ )**

**Figure 6. Output characteristics ( $T_J = 175\text{ }^\circ\text{C}$ )**

**Figure 7. Transfer characteristics**

**Figure 8. Collector current vs. case temperature**

**Figure 9. Leakage current vs. temperature**

**Figure 10. Normalized  $V_{CES(\text{clamped})}$  vs. temperature**

**Figure 11. Normalized  $V_{GE(\text{th})}$  vs. temperature**

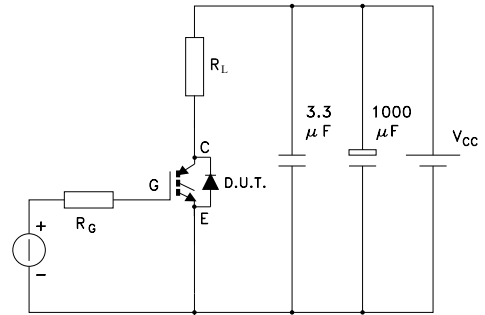
**Figure 12. Gate charge vs. gate-emitter voltage**

**Figure 13. Capacitance variations**

**Figure 14. Thermal impedance for DPAK**

**Figure 15. Thermal impedance for D<sup>2</sup>PAK**

### 3 Test circuits

**Figure 16. Test circuit for inductive load switching**

AM01504v1

**Figure 17. Test circuit for resistive load switching**

AM01504v2

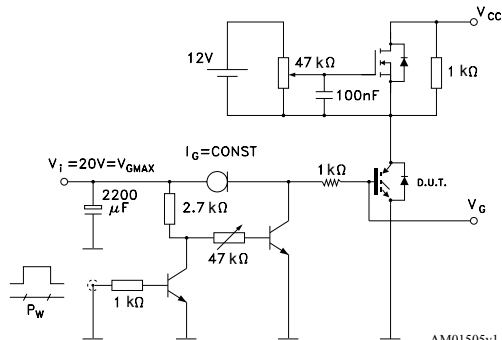
**Figure 18. Gate charge test circuit**

AM01505v1

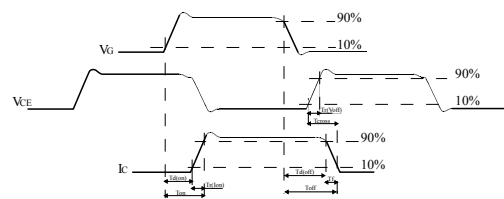
**Figure 19. Switching waveform**

AM01506v1



## 4 Package information

In order to meet environmental requirements, ST offers these devices in different grades of ECOPACK® packages, depending on their level of environmental compliance. ECOPACK® specifications, grade definitions and product status are available at: [www.st.com](http://www.st.com). ECOPACK® is an ST trademark.

### 4.1 D<sup>2</sup>PAK (TO-263) type A package information

Figure 20. D<sup>2</sup>PAK (TO-263) type A package outline

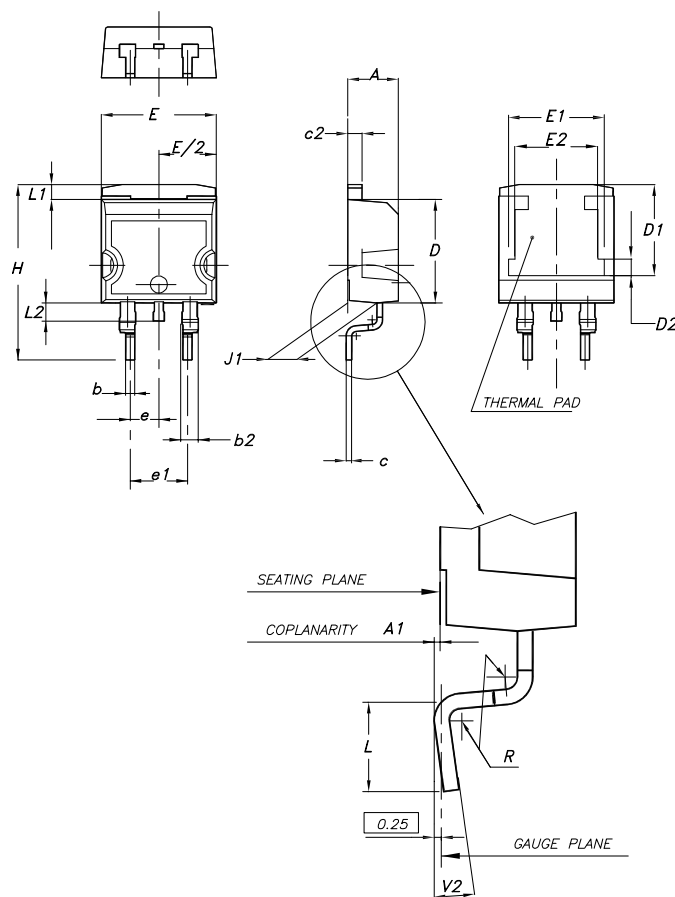

0079457\_24

Table 7. D<sup>2</sup>PAK (TO-263) type A package mechanical data

Dim.	mm		
	Min.	Typ.	Max.
A	4.40		4.60
A1	0.03		0.23
b	0.70		0.93
b2	1.14		1.70
c	0.45		0.60

Dim.	mm		
	Min.	Typ.	Max.
c2	1.23		1.36
D	8.95		9.35
D1	7.50	7.75	8.00
D2	1.10	1.30	1.50
E	10.00		10.40
E1	8.50	8.70	8.90
E2	6.85	7.05	7.25
e		2.54	
e1	4.88		5.28
H	15.00		15.85
J1	2.49		2.69
L	2.29		2.79
L1	1.27		1.40
L2	1.30		1.75
R		0.40	
V2	0°		8°

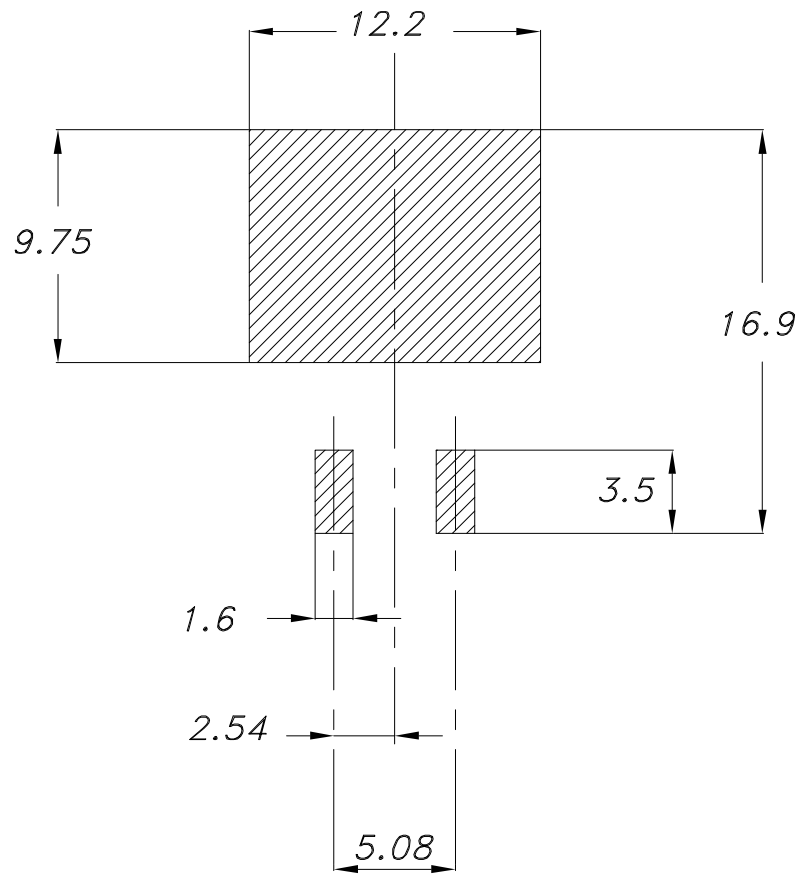
**Figure 21. D<sup>2</sup>PAK (TO-263) recommended footprint (dimensions are in mm)**

Footprint

**4.2 DPAK (TO-252) type A2 package information**

Figure 22. DPAK (TO-252) type A2 package outline



0068772\_type-A2\_rev24

**Table 8. DPAK (TO-252) type A2 mechanical data**

Dim.	mm		
	Min.	Typ.	Max.
A	2.20		2.40
A1	0.90		1.10
A2	0.03		0.23
b	0.64		0.90
b4	5.20		5.40
c	0.45		0.60
c2	0.48		0.60
D	6.00		6.20
D1	4.95	5.10	5.25
E	6.40		6.60
E1	5.10	5.20	5.30
e	2.16	2.28	2.40
e1	4.40		4.60
H	9.35		10.10
L	1.00		1.50
L1	2.60	2.80	3.00
L2	0.65	0.80	0.95
L4	0.60		1.00
R		0.20	
V2	0°		8°

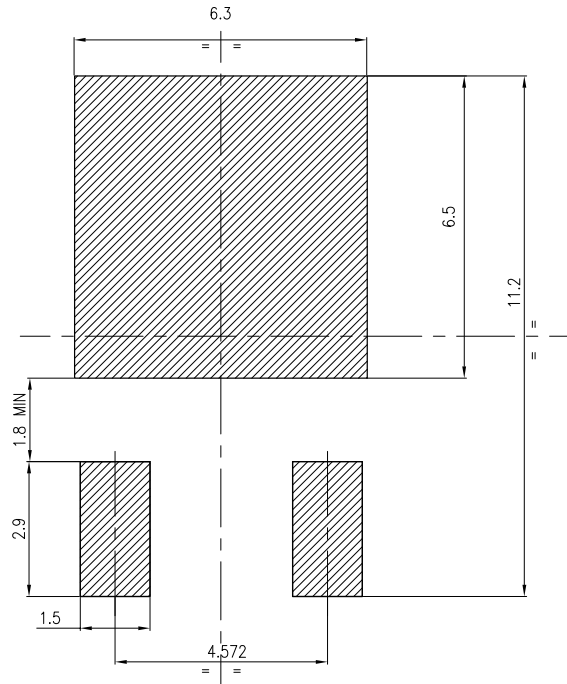
**Figure 23. DPAK (TO-252) recommended footprint (dimensions are in mm)**

FP\_0068772\_24

### 4.3 D<sup>2</sup>PAK and DPAK packing information

Figure 24. Tape outline



AM08852v1

**Figure 25. Reel outline**

AM06038v1

**Table 9. D<sup>2</sup>PAK tape and reel mechanical data**

Tape			Reel			
Dim.	mm		Dim.	mm		
	Min.	Max.		Min.	Max.	
A0	10.5	10.7	A		330	
B0	15.7	15.9	B	1.5		
D	1.5	1.6	C	12.8	13.2	
D1	1.59	1.61	D	20.2		
E	1.65	1.85	G	24.4	26.4	
F	11.4	11.6	N	100		
K0	4.8	5.0	T		30.4	
P0	3.9	4.1	Base quantity Bulk quantity			
P1	11.9	12.1				1000
P2	1.9	2.1				1000
R	50					
T	0.25	0.35				
W	23.7	24.3				



**Table 10. DPAK tape and reel mechanical data**

Tape			Reel		
Dim.	mm		Dim.	mm	
	Min.	Max.		Min.	Max.
A0	6.8	7	A		330
B0	10.4	10.6	B	1.5	
B1		12.1	C	12.8	13.2
D	1.5	1.6	D	20.2	
D1	1.5		G	16.4	18.4
E	1.65	1.85	N	50	
F	7.4	7.6	T		22.4
K0	2.55	2.75			
P0	3.9	4.1	Base qty.		2500
P1	7.9	8.1	Bulk qty.		2500
P2	1.9	2.1			
R	40				
T	0.25	0.35			
W	15.7	16.3			

## Revision history

**Table 11. Document revision history**

Date	Revision	Changes
05-Sep-2017	1	First release.
11-Sep-2017	2	Modified Section 4.1: "D <sup>2</sup> PAK (TO-263) type A package information". Minor text changes.
13-Feb-2018	3	Removed maturity status indication from cover page. Updated <a href="#">Table 1. Absolute maximum ratings</a> , <a href="#">Table 2. Thermal data</a> , <a href="#">Table 5. Resistive load switching characteristics</a> and <a href="#">Table 6. Inductive load switching characteristics</a> . Minor text changes.

## Contents

<b>1</b>	<b>Electrical ratings</b> .....	<b>2</b>
<b>2</b>	<b>Electrical characteristics</b> .....	<b>3</b>
<b>2.1</b>	<b>Electrical characteristics (curves)</b> .....	<b>5</b>
<b>3</b>	<b>Test circuits</b> .....	<b>8</b>
<b>4</b>	<b>Package information</b> .....	<b>9</b>
<b>4.1</b>	<b>D<sup>2</sup>PAK (TO-263) type A package information</b> .....	<b>9</b>
<b>4.2</b>	<b>DPAK (TO-252) type A2 package information</b> .....	<b>11</b>
<b>4.3</b>	<b>D<sup>2</sup>PAK and DPAK packing information</b> .....	<b>14</b>
	<b>Revision history</b> .....	<b>18</b>
	<b>Contents</b> .....	<b>19</b>
	<b>Disclaimer</b> .....	<b>20</b>

**IMPORTANT NOTICE – PLEASE READ CAREFULLY**

STMicroelectronics NV and its subsidiaries (“ST”) reserve the right to make changes, corrections, enhancements, modifications, and improvements to ST products and/or to this document at any time without notice. Purchasers should obtain the latest relevant information on ST products before placing orders. ST products are sold pursuant to ST’s terms and conditions of sale in place at the time of order acknowledgement.

Purchasers are solely responsible for the choice, selection, and use of ST products and ST assumes no liability for application assistance or the design of Purchasers’ products.

No license, express or implied, to any intellectual property right is granted by ST herein.

Resale of ST products with provisions different from the information set forth herein shall void any warranty granted by ST for such product.

ST and the ST logo are trademarks of ST. All other product or service names are the property of their respective owners.

Information in this document supersedes and replaces information previously supplied in any prior versions of this document.

© 2018 STMicroelectronics – All rights reserved

Компания «Life Electronics» занимается поставками электронных компонентов импортного и отечественного производства от производителей и со складов крупных дистрибьюторов Европы, Америки и Азии.

С конца 2013 года компания активно расширяет линейку поставок компонентов по направлению коаксиальный кабель, кварцевые генераторы и конденсаторы (керамические, пленочные, электролитические), за счёт заключения дистрибьюторских договоров

Мы предлагаем:

- Конкурентоспособные цены и скидки постоянным клиентам.
- Специальные условия для постоянных клиентов.
- Подбор аналогов.
- Поставку компонентов в любых объемах, удовлетворяющих вашим потребностям.
- Приемлемые сроки поставки, возможна ускоренная поставка.
- Доставку товара в любую точку России и стран СНГ.
- Комплексную поставку.
- Работу по проектам и поставку образцов.
- Формирование склада под заказчика.
- Сертификаты соответствия на поставляемую продукцию (по желанию клиента).
- Тестирование поставляемой продукции.
- Поставку компонентов, требующих военную и космическую приемку.
- Входной контроль качества.
- Наличие сертификата ISO.

В составе нашей компании организован Конструкторский отдел, призванный помогать разработчикам, и инженерам.

Конструкторский отдел помогает осуществить:

- Регистрацию проекта у производителя компонентов.
- Техническую поддержку проекта.
- Защиту от снятия компонента с производства.
- Оценку стоимости проекта по компонентам.
- Изготовление тестовой платы монтаж и пусконаладочные работы.



Тел: +7 (812) 336 43 04 (многоканальный)

Email: [org@lifeelectronics.ru](mailto:org@lifeelectronics.ru)