

LOC		DIST		REVISIONS			
P	LTN	DESCRIPTION	DATE	DWN	APVD		
	H4	ADDED DASH NUMBER -33	25FEB2013	CZ	SZ		

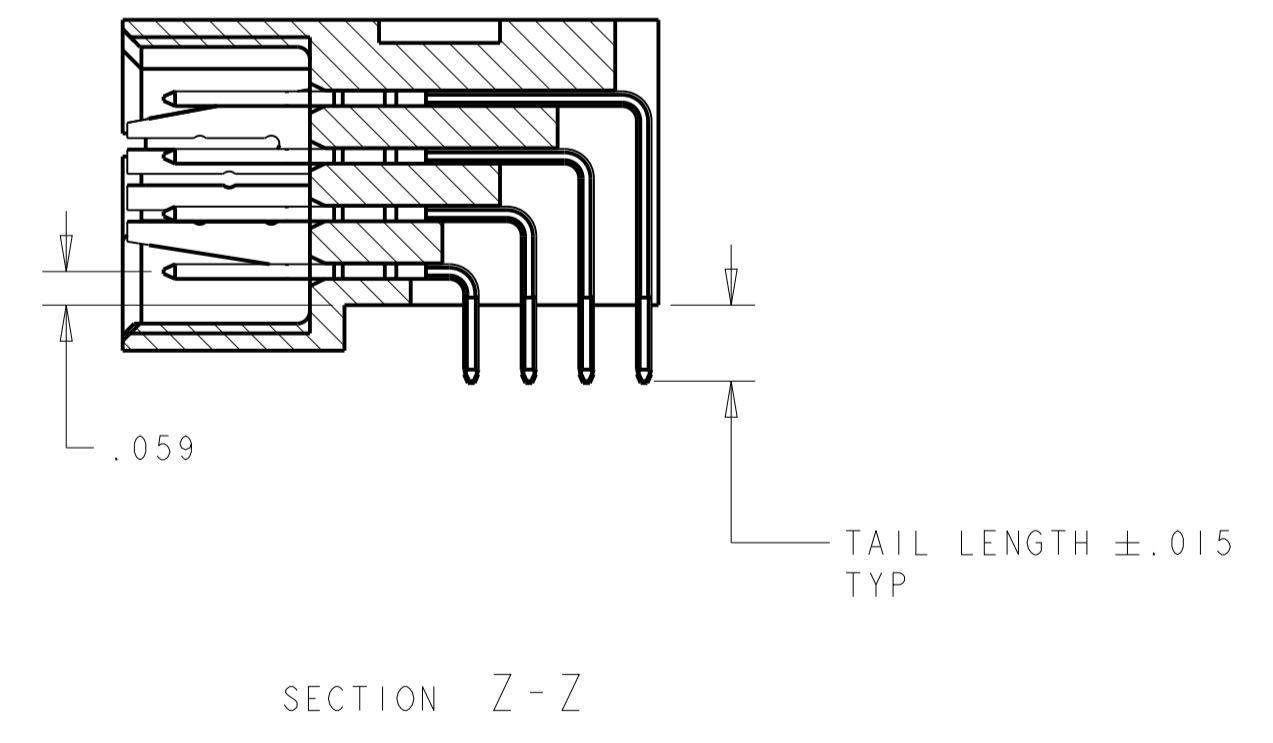
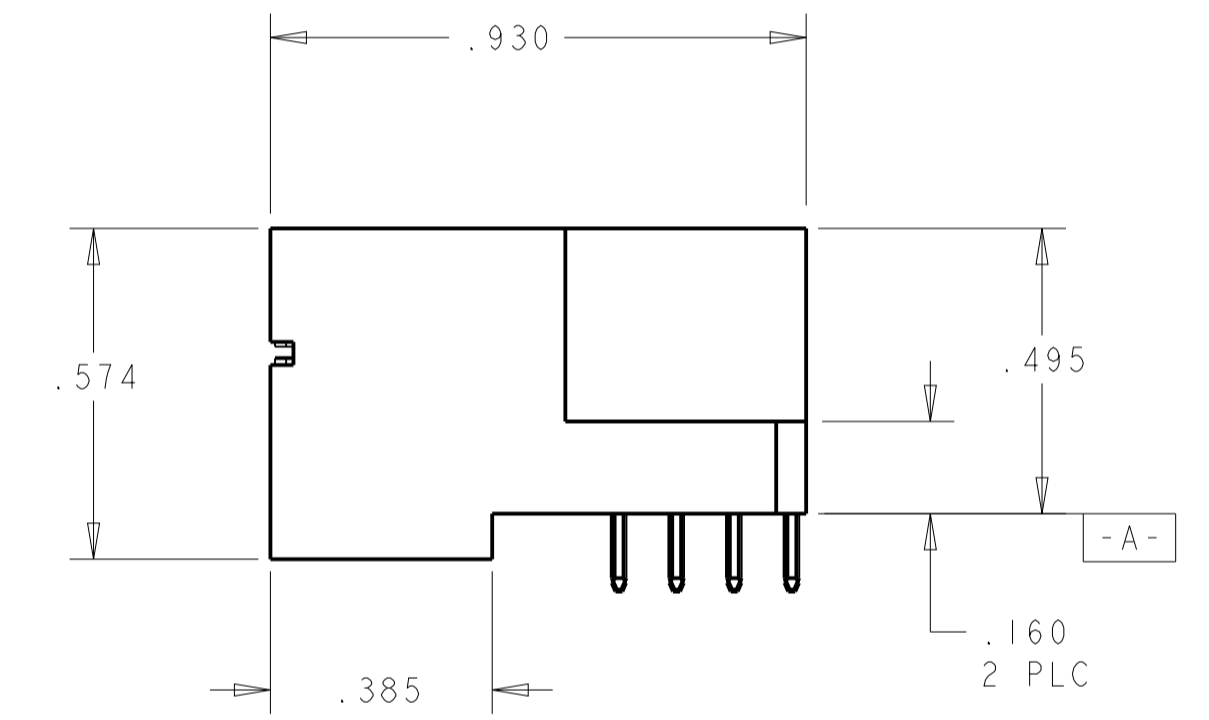
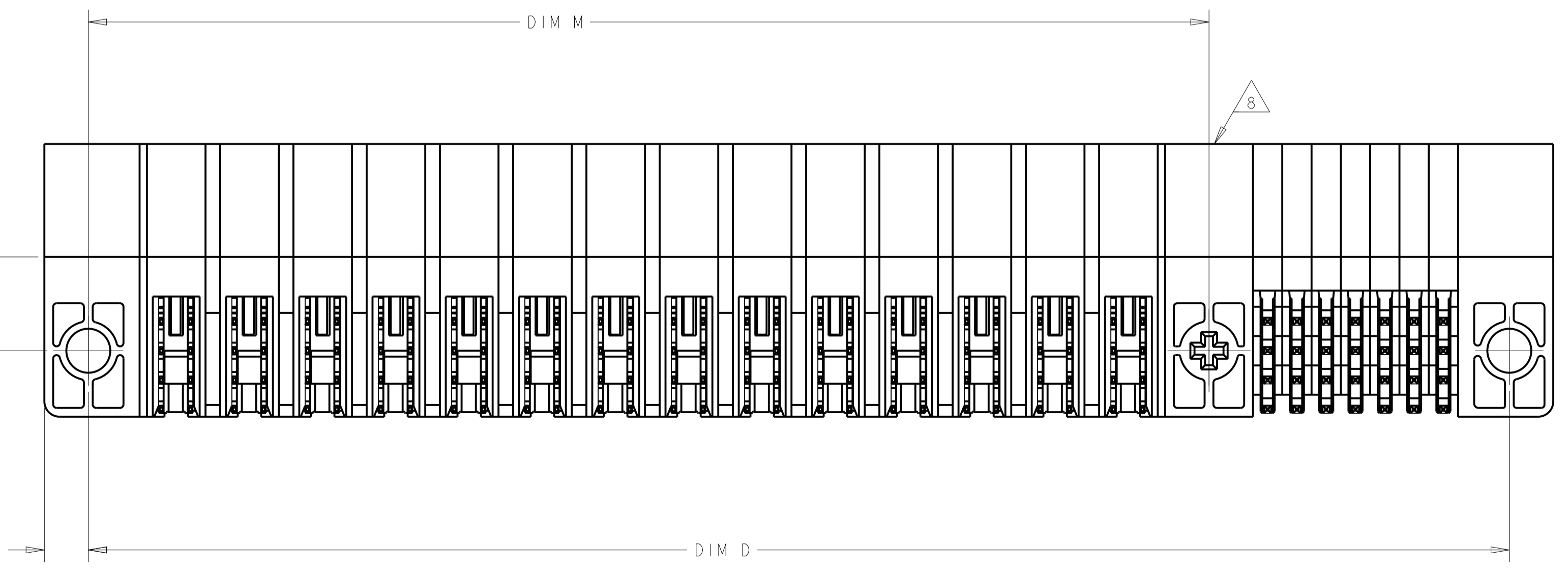
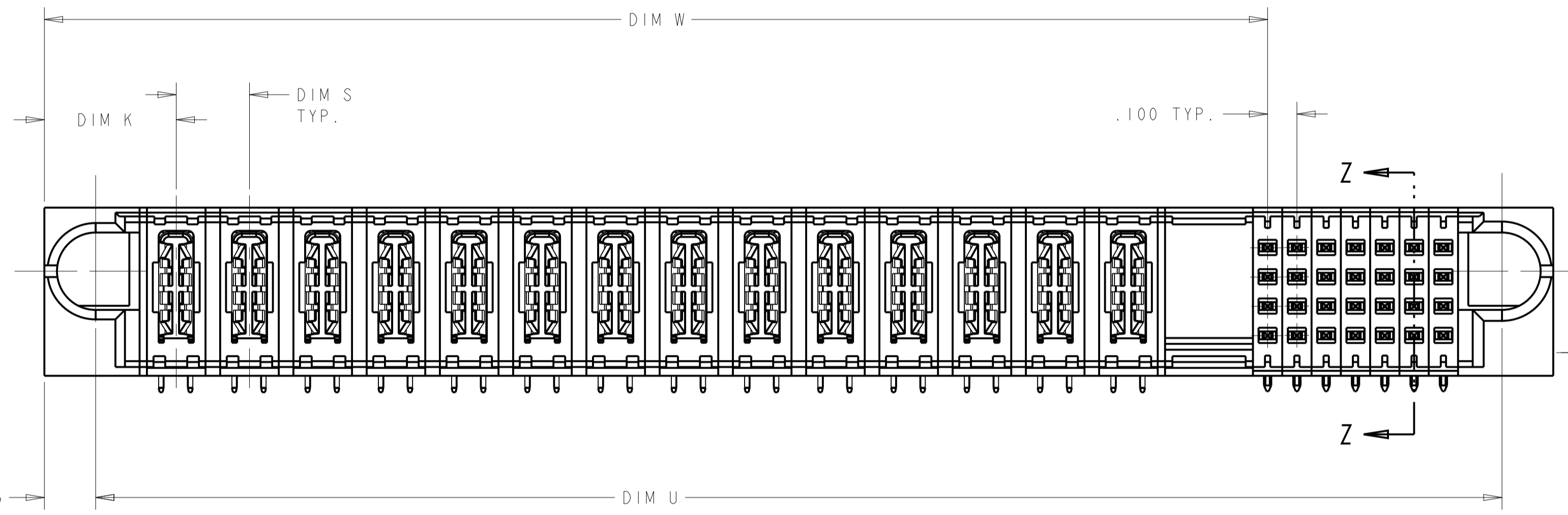
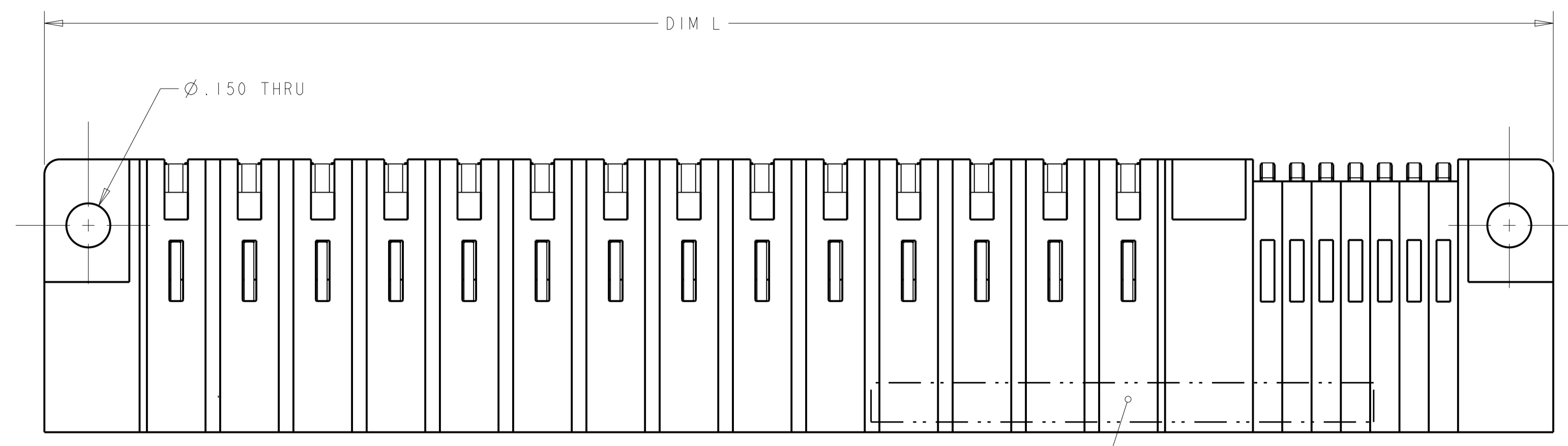

THIS DRAWING IS A CONTROLLED DOCUMENT.		DWN R. GRZYBOWSKI 24JAN05	TE Connectivity <b>RIGHT ANGLE SOLDER HEADER ASSEMBLY MULTI-BEAM XL</b>	
DIMENSIONS: INCHES		CHK M. PERCHERKE 24JAN05		
TOLERANCES UNLESS OTHERWISE SPECIFIED:		APVD M. PERCHERKE	PRODUCT SPEC	RESTRICTED TO
0 PLC $\pm .01$ 1 PLC $\pm .01$ 2 PLC $\pm .01$ 3 PLC $\pm .005$ 4 PLC $\pm .002$ ANGLES $\pm .020$		APPLICATION SPEC	108-1973	SIZE
MATERIAL		FINISH	114-13038	CAGE CODE
		WEIGHT	-	DRAWING NO
		CUSTOMER DRAWING	A100779	SCALE
		SCALE	4:1	SHEET
		SHEET	1	OF
		REV	13	REV
		REV	H6	

LOC	DIST	REVISIONS			
		REV	DATE	BY	APPROV
ES	00	-	-	-	-
		SEE SHEET 1			

- 1 "AMP", PART NUMBER, AND DATECODE TO BE MARKED IN AREA SHOWN.
- 2 MATERIAL: HOUSING - GLASS FILLED HIGH TEMP THERMO PLASTIC, UL94 V-0  
 SIGNAL CONTACT - COPPER ALLOY  
 POWER CONTACT - HIGH CONDUCTIVITY COPPER ALLOY
- 3 CONTACT PLATING: NOBLE METAL PLATING ON CONTACT FUNCTIONAL AREA OF POWER AND SIGNAL CONTACTS
- 4 MECHANICAL CONNECTOR KEEP OUT ZONE.
- 5 DATUM AND BASIC DIMENSIONS ESTABLISHED BY CUSTOMER.
- 6 PCB - HOLE DIAMETERS ARE FINISHED HOLE SIZE.
- 7 PCB - .0453±.0010 DRILLED HOLES PLATED WITH .0003 MIN Sn OVER .001 TO .003 Cu PLATING TO ACHIEVE A .040 DIAMETER HOLE.
- 8 OPTIONAL CENTER MODULE
- 9 NOT RELEASED FOR PRODUCTION
- 10 VARIABLE DIMENSIONS SHOWN ON TABLE

DIM U	DIM S	DIM W	DIM D	DIM M	DIM L	DIM K	DESCRIPTION	PART NUMBER
1.900	.250	1.375	1.950	-	2.250	.450	4P + 24S	3-6450332-4
2.825	△	2.300	2.875	-	3.175	.475	3ACP + 4P + 24S	3-6450332-3
1.600	.250	1.375	1.650	-	1.950	.450	4P + 12S	3-6450332-2
2.825	△	2.300	2.875	-	3.175	.475	3ACP + 4P + 24S	3-6450332-1
3.225	△	2.675	3.275	-	3.575	.525	9P + 24S	3-6450332-0
2.700	△	2.275	2.750	-	3.050	.450	4ACP+3P+20S	1-6450332-9
3.225	△	2.675	3.275	-	3.575	.525	3ACP+6P+24S	2-6450332-8
1.650	.200	1.225	1.700	-	2.000	.450	4P + 20S	2-6450332-6
1.800	△	1.275	1.850	-	2.150	.450	4P + 24S	2-6450332-5
2.900	.250	2.375	2.950	-	3.250	.450	8P + 24S	2-6450332-4
3.225	△	2.675	3.275	-	3.575	.525	3ACP+6P+24S	2-6450332-3
2.150	.250	1.625	2.200	-	2.500	.450	5P + 24S	2-6450332-0
3.225	△	2.675	3.275	-	3.575	.525	3ACP+6P+24S	6450332-9
3.875	△	3.550	3.925	-	4.225	.475	1ACP + 9P + 16S	1-6450332-8
2.300	.250	1.875	2.350	-	2.650	.450	6P+20S	1-6450332-7
3.875	△	3.550	3.925	-	4.225	.475	3ACP+9P+16S	1-6450332-6
5.100	△	2.375	5.150	-	5.450	.450	8P + 112S	1-6450332-4
3.800	△	3.175	3.850	-	4.150	.450	12P + 28S	1-6450332-3
2.275	△	2.050	2.325	-	2.625	.450	5P + 24S	1-6450332-2
1.400	.250	.875	1.450	-	1.750	.450	2P + 24S	6450332-8
1.100	-	.575	1.150	-	1.450	.425	1P + 24S	6450332-6
4.425	.250	3.875	4.475	-	4.775	.450	14P + 24S	6450332-5
2.675	.250	2.125	2.725	-	3.025	.450	7P + 24S	6450332-4
2.925	.250	2.375	2.975	-	3.275	.450	8P + 24S	6450332-3
4.500	.250	3.875	4.550	-	4.850	.450	14P + 28S	6450332-2

THIS DRAWING IS A CONTROLLED DOCUMENT. DWN: R. GRZYBOWSKI, 24JAN05  
 CHK: M. PERCHERKE, 24JAN05

**STE** TE Connectivity

NAME: RIGHT ANGLE SOLDER HEADER ASSEMBLY MULTI-BEAM XL

PRODUCT SPEC: 108-1973  
 APPLICATION SPEC: 114-13038

SIZE: A1 CAGE CODE: 6450332 DRAWING NO: 100779

SCALE: 4:1 SHEET 2 OF 13 REV: H6

LOC	DIST	REVISIONS			
ES	00	REV	DATE	BY	APPV
		1			
		2			

ASSY PART NUMBER	ROWS	POWER														SIGNAL						
		P1	P2	P3	P4	P5	P6	P7	P8	P9	P10	P11	P12	P13	P14	1	2	3	4	5	6	7
6450332-2	D C B A	PM	PM	PM	PM	PM	PM	PM	PM	PM	PM	PM	PM	PM	E	E	E	E	E	E	E	E
14P + 28S															F	F	F	F	F	F	F	F
															G	G	G	G	G	G	G	G
															S	S	S	S	S	H	H	H

PART NUMBER	ROWS	POWER								SIGNAL					
		P1	P2	P3	P4	P5	P6	P7	P8	1	2	3	4	5	6
6450332-3	D C B A	PM	PM	PM	PM	PM	PM	PM	PM	J	J	J	J	E	E
8P + 24S										K	K	K	K	F	F
										N	N	N	N	G	G
										S	S	S	S	H	H

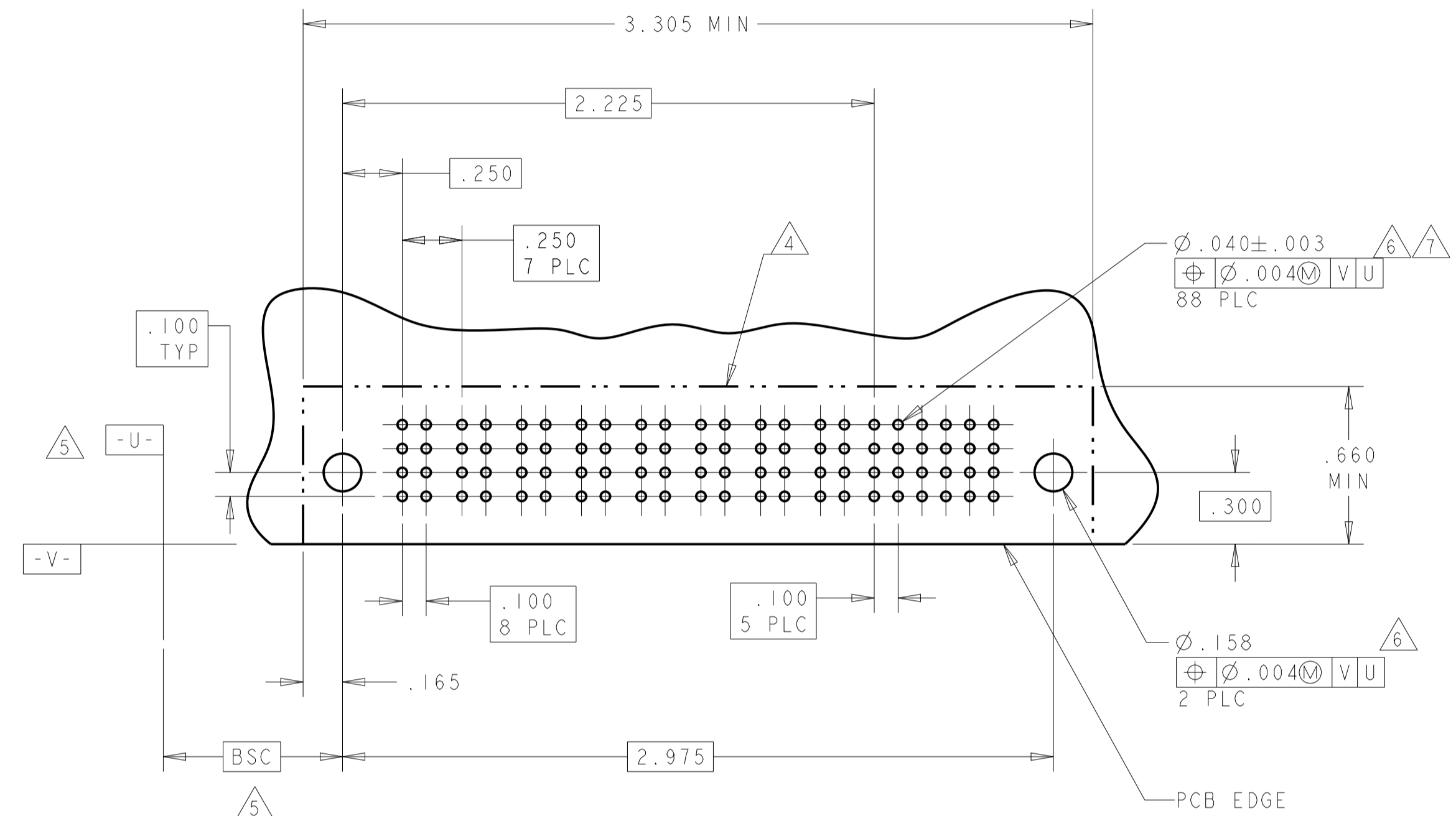
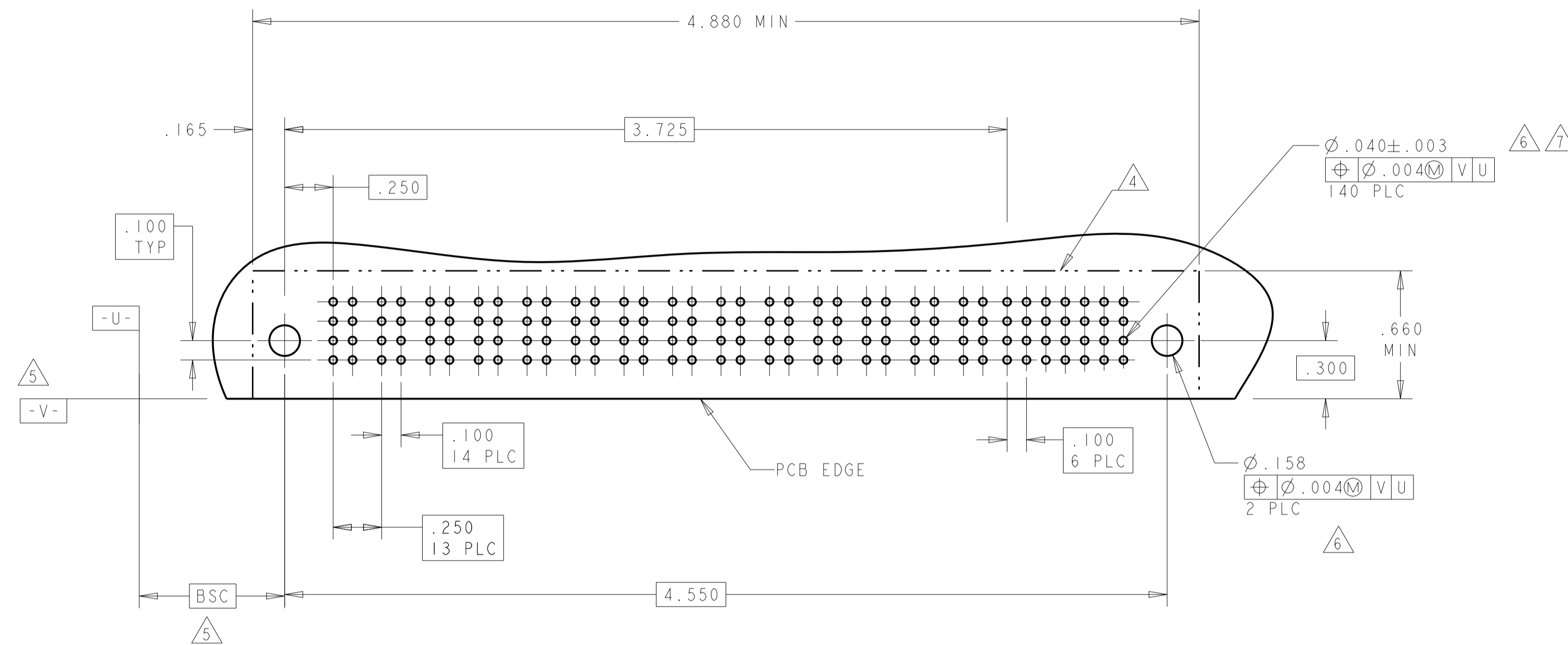

PART NUMBER	ROWS	POWER							SIGNAL					
		P1	P2	P3	P4	P5	P6	P7	1	2	3	4	5	6
6450332-4	D C B A	PM	PM	PM	PM	PM	PM	PM	J	J	E	J	J	J
7P + 24S									K	K	K	K	K	K
									N	N	N	N	N	N
									S	S	S	S	S	S

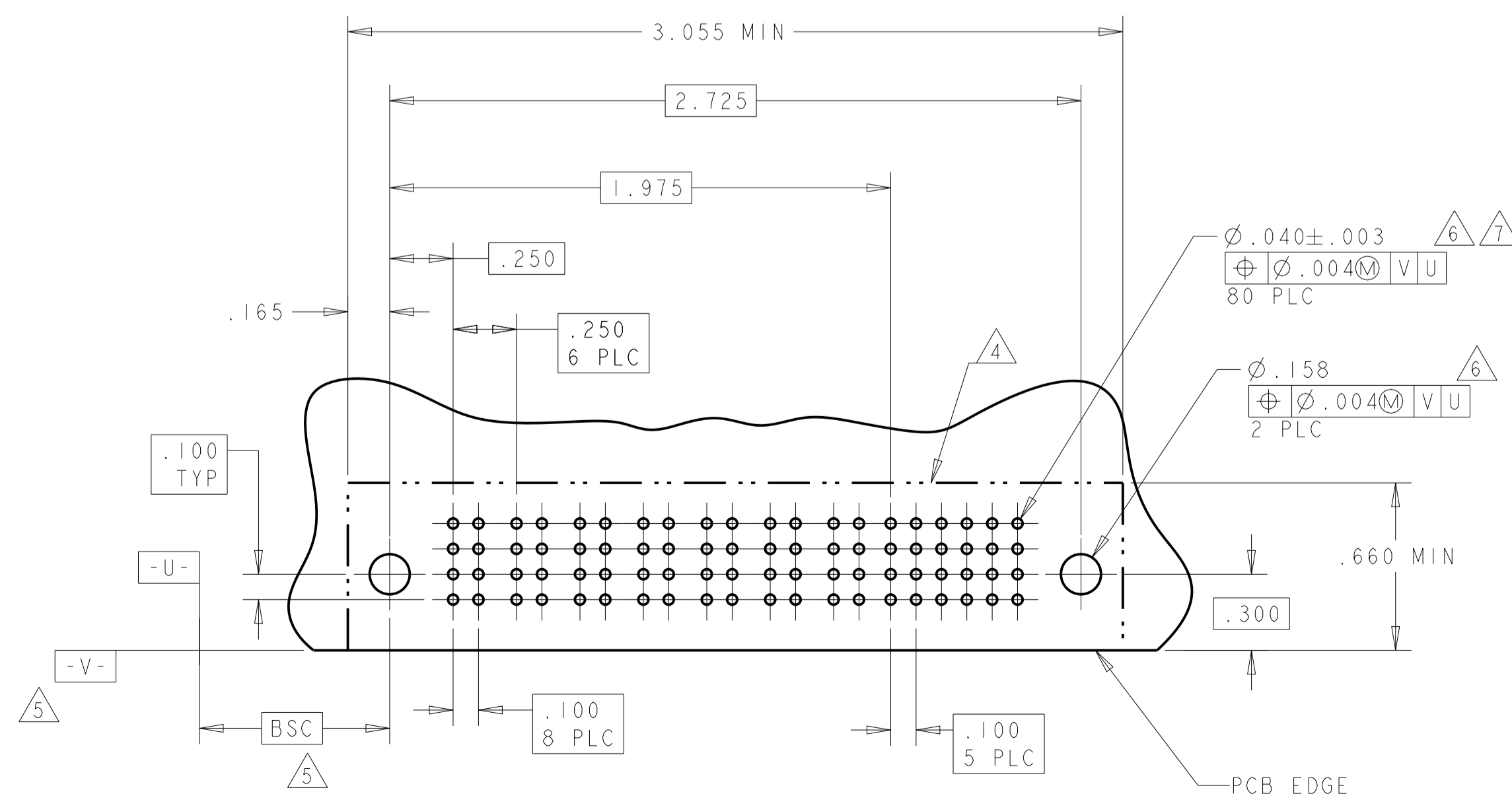

CODE	MATING SEQUENCE	TAIL LENGTH	ROW
Z	STD	.090	D
Y	STD	.090	C
R	STD	.090	B
O	STD	.090	A
A4	MLBF	.090	D
A3	MLBF	.090	C
A2	MLBF	.090	B
A1	MLBF	.090	A
E	MLBF	.135	D
F	MLBF	.135	C
G	MLBF	.135	B
H	MLBF	.135	A
J	STD	.135	D
K	STD	.135	C
N	STD	.135	B
S	STD	.135	A

CODE	TAIL LENGTH
PA	.090
PM	.135

THIS DRAWING IS A CONTROLLED DOCUMENT. **STE** TE Connectivity

APV: M. PERCHERKE  
 PRODUCT SPEC: 108-1973  
 APPLICATION SPEC: 114-13038  
 WEIGHT: A100779  
 SCALE: 4:1 SHEET 3 OF 13 REV: H6

RIGHT ANGLE SOLDER HEADER ASSEMBLY MULTI-BEAM XL

LOC		DIST		REVISIONS			
ES	00	P	LTN	DESCRIPTION	DATE	DMN	APVD
-	-	-	-	SEE SHEET 1	-	-	-

PART NUMBER	ROWS	POWER														SIGNAL					
		P1	P2	P3	P4	P5	P6	P7	P8	P9	P10	P11	P12	P13	P14	1	2	3	4	5	6
6450332-5	D C B A	PM	PM	PM	PM	PM	PM	PM	PM	PM	PM	PM	PM	PM	PM	E	E	E	E	E	E
		F	F	F	F	F	F	F	F	F	F	F	F	F	F	F	F	F	F	F	F
		G	G	G	G	G	G	G	G	G	G	G	G	G	G	G	G	G	G	G	G
		H	H	S	S	H	H									H	H	S	S	H	H
14P + 24S																					

PART NUMBER	ROWS	POWER					SIGNAL					
		P1	P2	P3	P4	P5	1	2	3	4	5	6
1-6450332-2	D C B A	PM	PM	PM	PM	PM						
		J	J	J								
		K	K	K								
		N	N	N								
5P + 24S							NO CONTACTS LOADED					

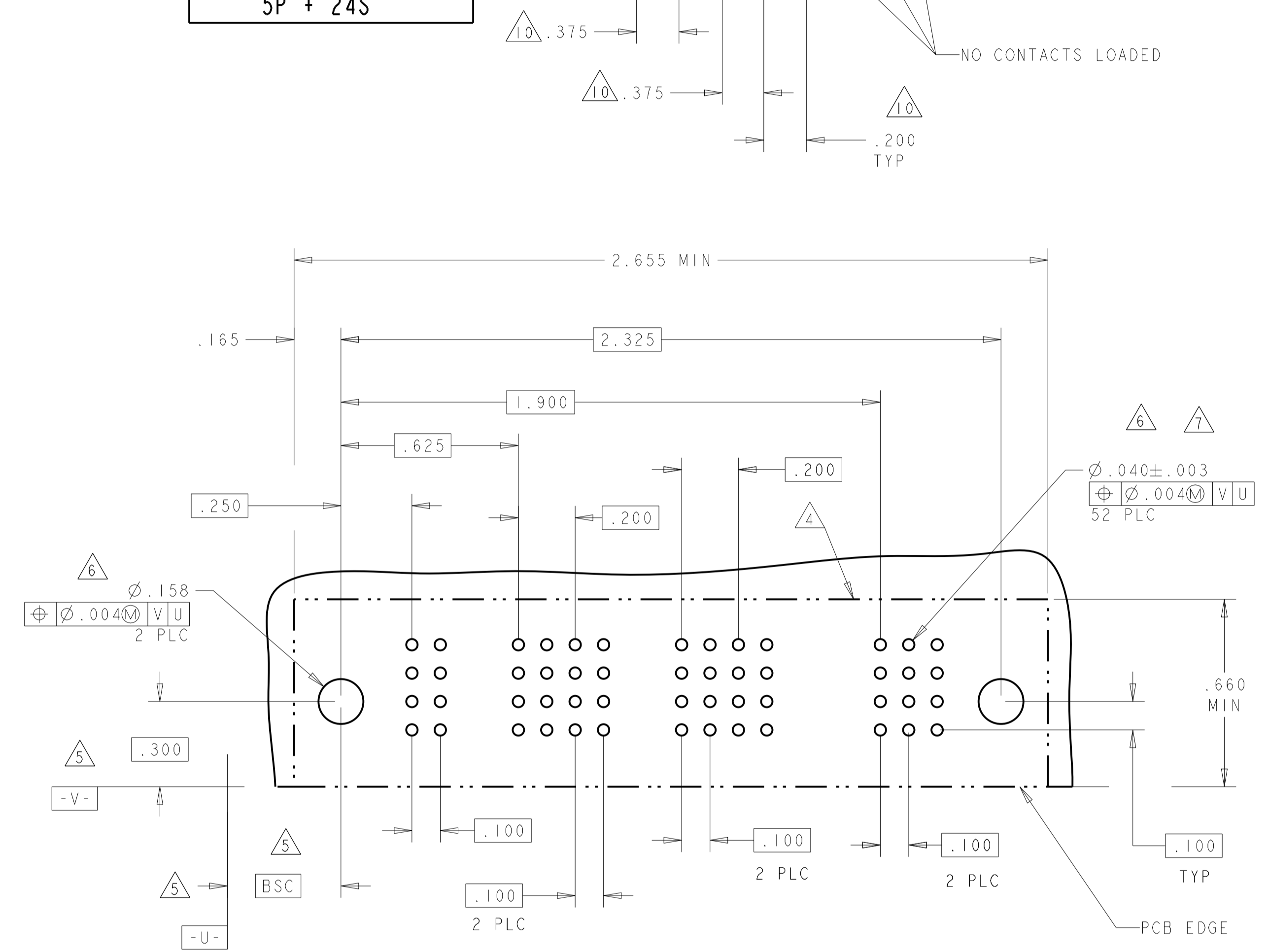
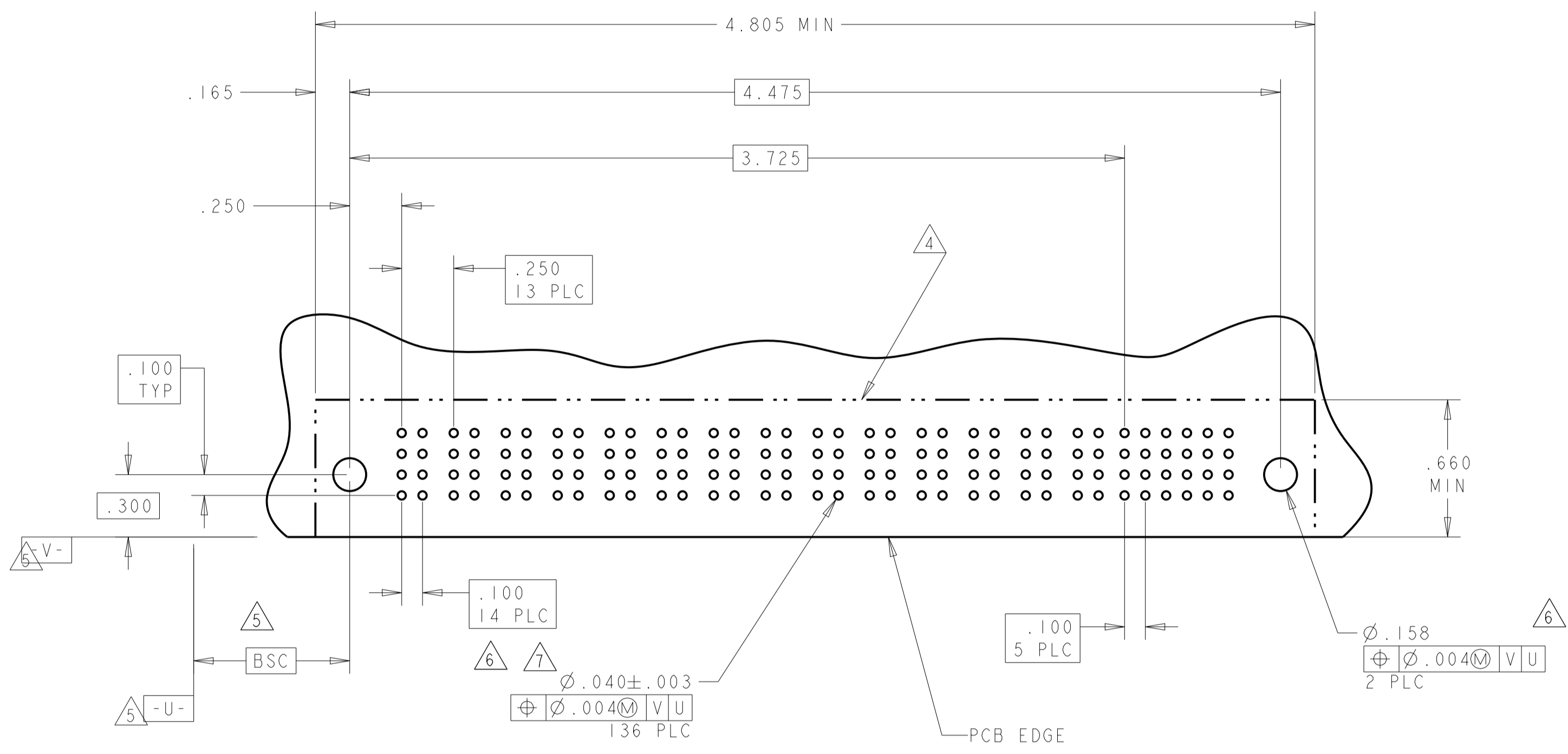

PART NUMBER	ROWS	POWER														SIGNAL					
		P1	1	2	3	4	5	6													
6450332-6	D C B A	PM	E	E	E	E	E	J													
		F	F	F	F	F	F	F													
		G	G	G	G	G	G	G													
		H	H	H	H	H	H	H													
1P + 24S																					

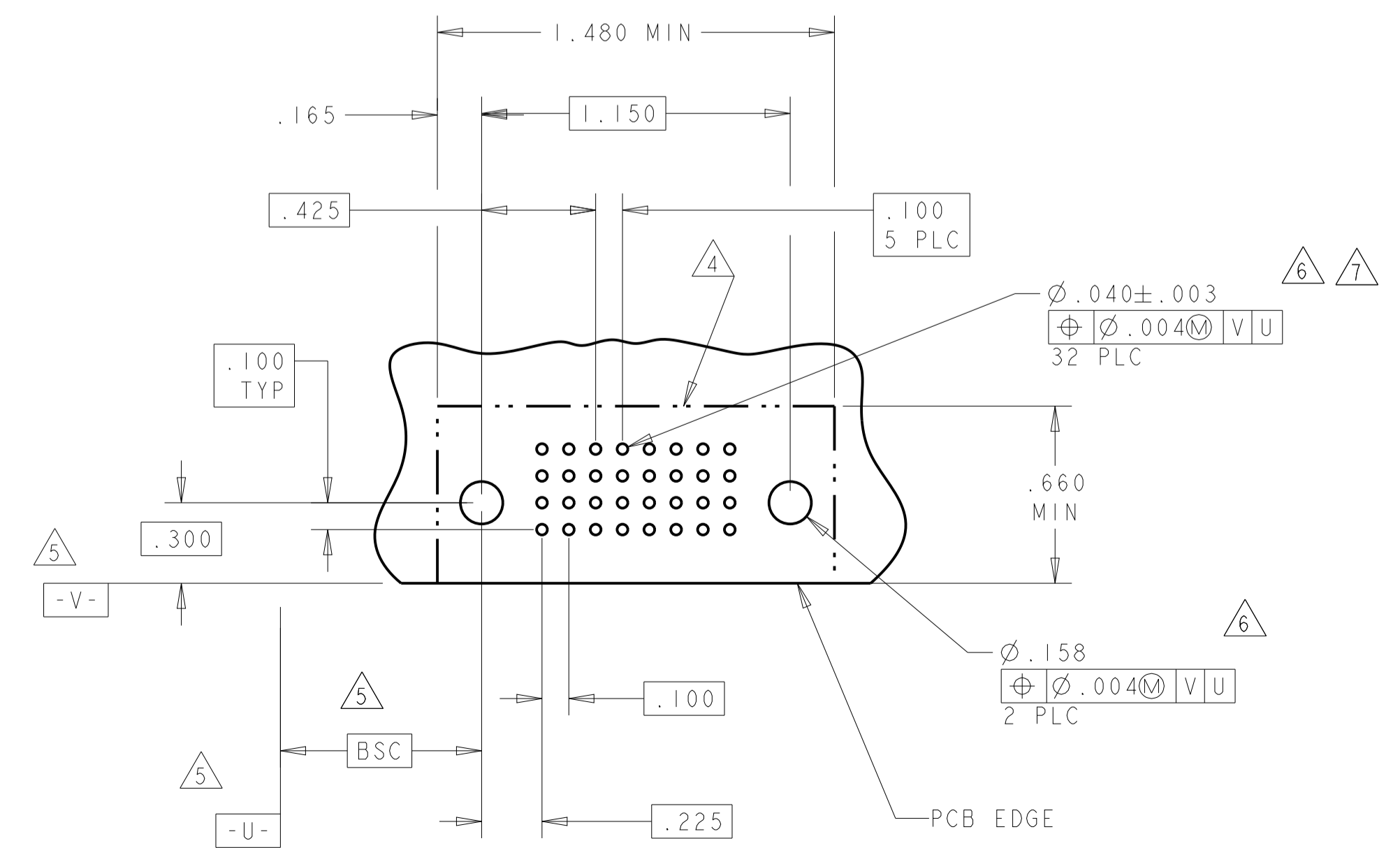

THIS DRAWING IS A CONTROLLED DOCUMENT.		DMN R. GRZYBOWSKI 24JAN05	24JAN05	<b>STE</b> TE Connectivity
DIMENSIONS: INCHES		CHK M. PERCHERKE 24JAN05	NAME RIGHT ANGLE SOLDER HEADER ASSEMBLY MULTI-BEAM XL	
TOLERANCES UNLESS OTHERWISE SPECIFIED: 0 PLC ±.01 1 PLC ±.01 2 PLC ±.01 3 PLC ±.005 4 PLC ±.002 ANGLES ±.020		APVD M. PERCHERKE	PRODUCT SPEC 108-1973	SIZE 114-13038
MATERIAL	FINISH	WEIGHT	RESTRICTED TO	
CUSTOMER DRAWING		SCALE 4:1 SHEET 4 OF 13 REV H6		

LOC	DIST	REVISIONS			
ES	00	REV	DATE	BY	APPV
		1			
		2			
		3			
		4			
		5			
		6			
		7			
		8			
		9			
		10			
		11			
		12			
		13			
		14			
		15			
		16			
		17			
		18			
		19			
		20			
		21			
		22			
		23			
		24			
		25			
		26			
		27			
		28			

PART NUMBER	ROWS	POWER												SIGNAL						
		P1	P2	P3	P4	P5	P6	P7	P8	P9	P10	P11	P12	1	2	3	4	5	6	7
1-6450332-3	D C B A	PM	PM	PM	PM	PM	PM	PM	PM	PM	PM	PM	PM	J				J	J	J
														K				K	K	K
														N				N	N	N
														S				S	S	S

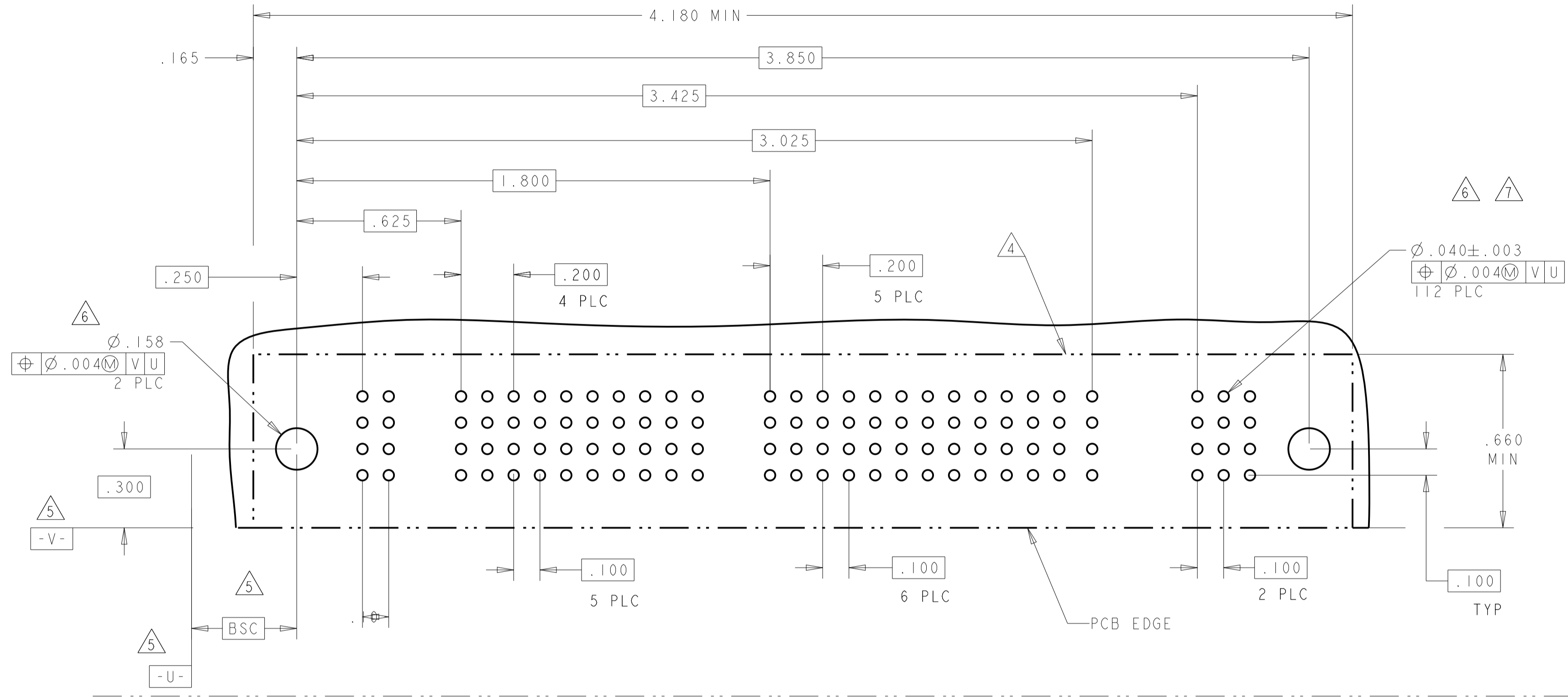
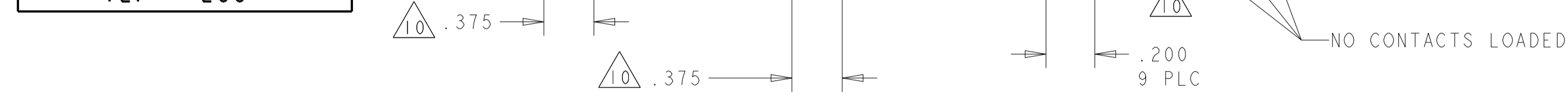

PART NUMBER	ROWS	POWER								SIGNAL																															
		P1	P2	P3	P4	P5	P6	P7	P8	1	2	3	4	5	6	7	8	9	10	11	12	13	14	15	16	17	18	19	20	21	22	23	24	25	26	27	28				
1-6450332-4	D C B A	PM	PM	PM	PM	PM	PM	PM	PM	J				J	J	J	J	J	J	J	J	J	J	J	J	J	J	J	J	J	J	J	J	J	J	J	J	J	J		
										K				K	K	K	K	K	K	K	K	K	K	K	K	K	K	K	K	K	K	K	K	K	K	K	K	K	K		
										N				N	N	N	N	N	N	N	N	N	N	N	N	N	N	N	N	N	N	N	N	N	N	N	N	N	N	N	N
										S				S	S	S	S	S	S	S	S	S	S	S	S	S	S	S	S	S	S	S	S	S	S	S	S	S	S	S	S

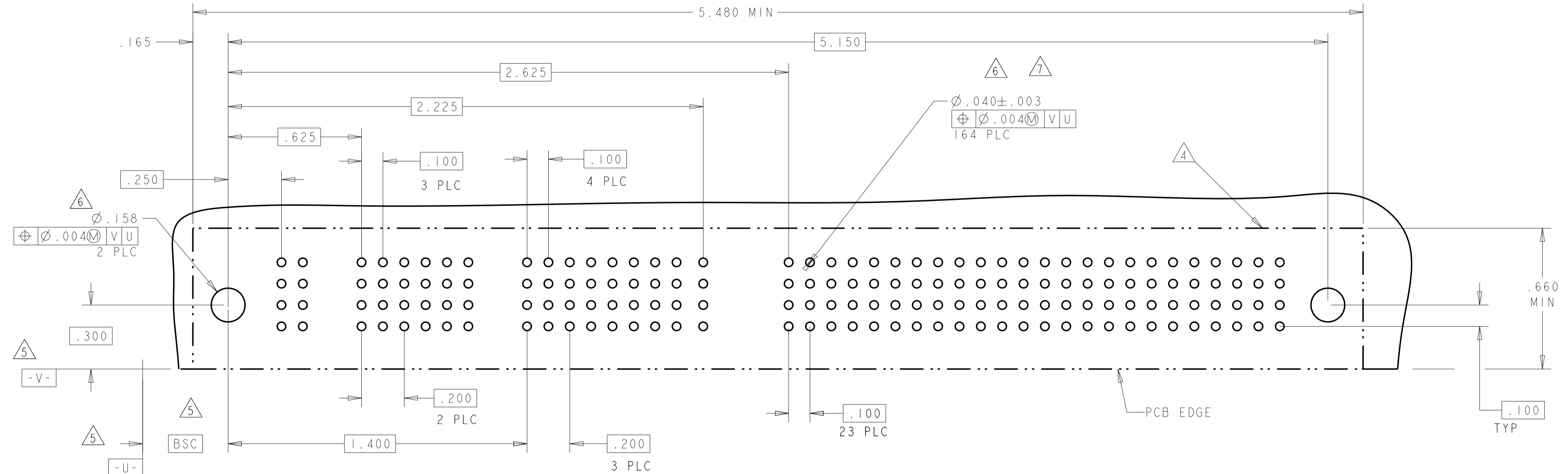
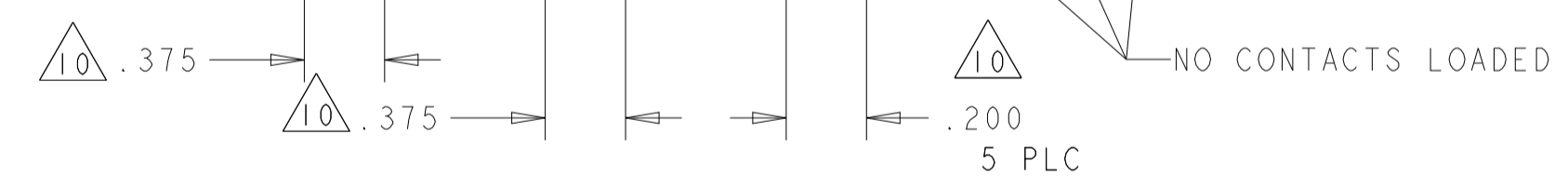

THIS DRAWING IS A CONTROLLED DOCUMENT.		OWN: R. GRZYBOWSKI 24JAN05		TE Connectivity
DIMENSIONS: INCHES		CHK: M. PERCHERKE 24JAN05		NAME: RIGHT ANGLE SOLDER HEADER ASSEMBLY MULTI-BEAM XL
TOLERANCES UNLESS OTHERWISE SPECIFIED:		APVD: M. PERCHERKE	PRODUCT SPEC: 108-1973	
0 PLC ±.01		PRODUCT SPEC: 114-13038	APPLICATION SPEC: 114-13038	
1 PLC ±.01		WEIGHT: -	RESTRICTED TO: -	
2 PLC ±.01		SCALE: 4:1	SHEET 5 OF 13	
3 PLC ±.005		REV: H6	CAGE CODE: A100779	
4 PLC ±.0020		SCALE: 4:1	DRAWING NO: 6450332	
ANGLES ±.2°		SCALE: 4:1	SHEET 5 OF 13	
MATERIAL: -		SCALE: 4:1	SHEET 5 OF 13	
FINISH: -		SCALE: 4:1	SHEET 5 OF 13	
MATERIAL: -		SCALE: 4:1	SHEET 5 OF 13	
FINISH: -		SCALE: 4:1	SHEET 5 OF 13	

LOC	DIST	REVISIONS			
P	LTN	DESCRIPTION	DATE	DMN	APVD
ES	00	SEE SHEET 1			

PART NUMBER	ROWS	POWER												SIGNAL			
		P1	P2	P3	P4	P5	P6	P7	P8	P9	P10	P11	P12	1	2	3	4
I-6450332-6	D C B A	PM	PM	PM	PM	PM	PM	PM	PM	PM	PM	PM	PM	J	J	J	J
		PM	PM	PM	PM	PM	PM	PM	PM	PM	PM	PM	PM	K	K	K	K
		PM	PM	PM	PM	PM	PM	PM	PM	PM	PM	PM	PM	N	N	N	N
		PM	PM	PM	PM	PM	PM	PM	PM	PM	PM	PM	PM	S	S	S	H

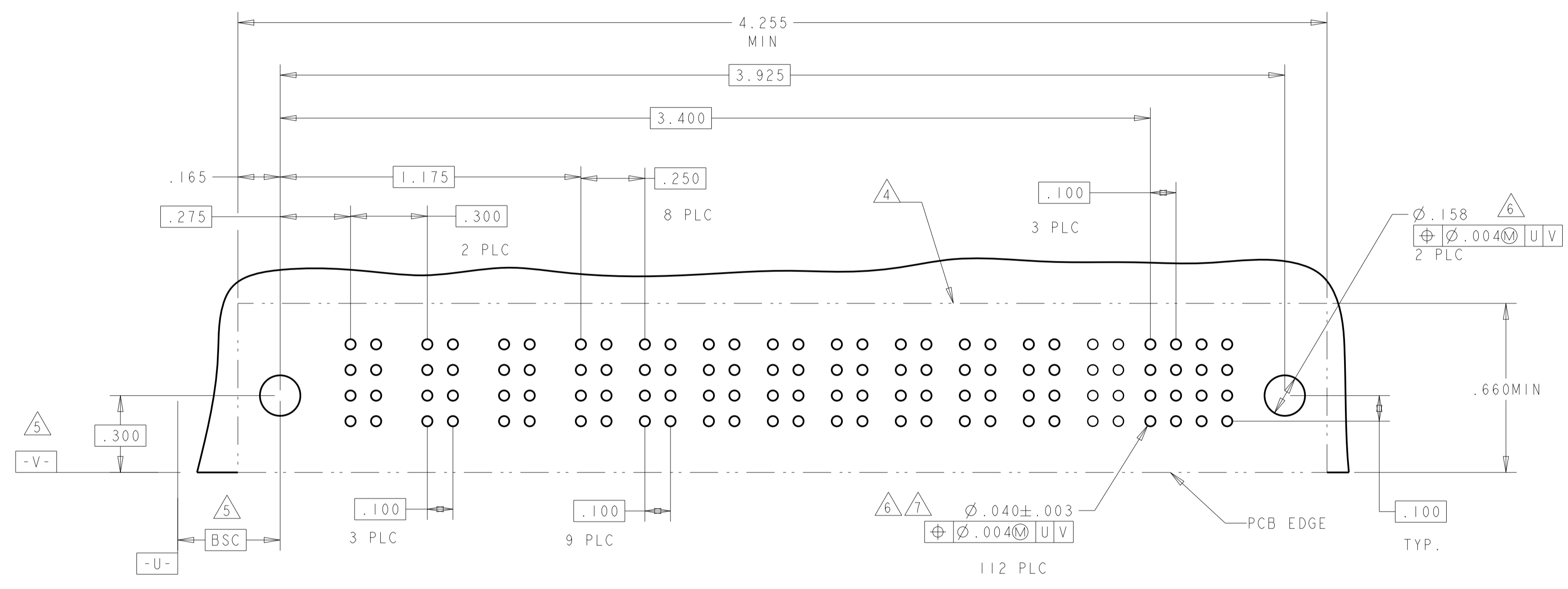

PART NUMBER	ROWS	POWER						SIGNAL				
		P1	P2	P3	P4	P5	P6	1	2	3	4	5
I-6450332-7	D C B A	PM	PM	PM	PM	PM	PM	J	J	J	J	J
		PM	PM	PM	PM	PM	PM	K	K	K	K	K
		PM	PM	PM	PM	PM	PM	N	N	N	N	N
		PM	PM	PM	PM	PM	PM	H	S	S	S	S

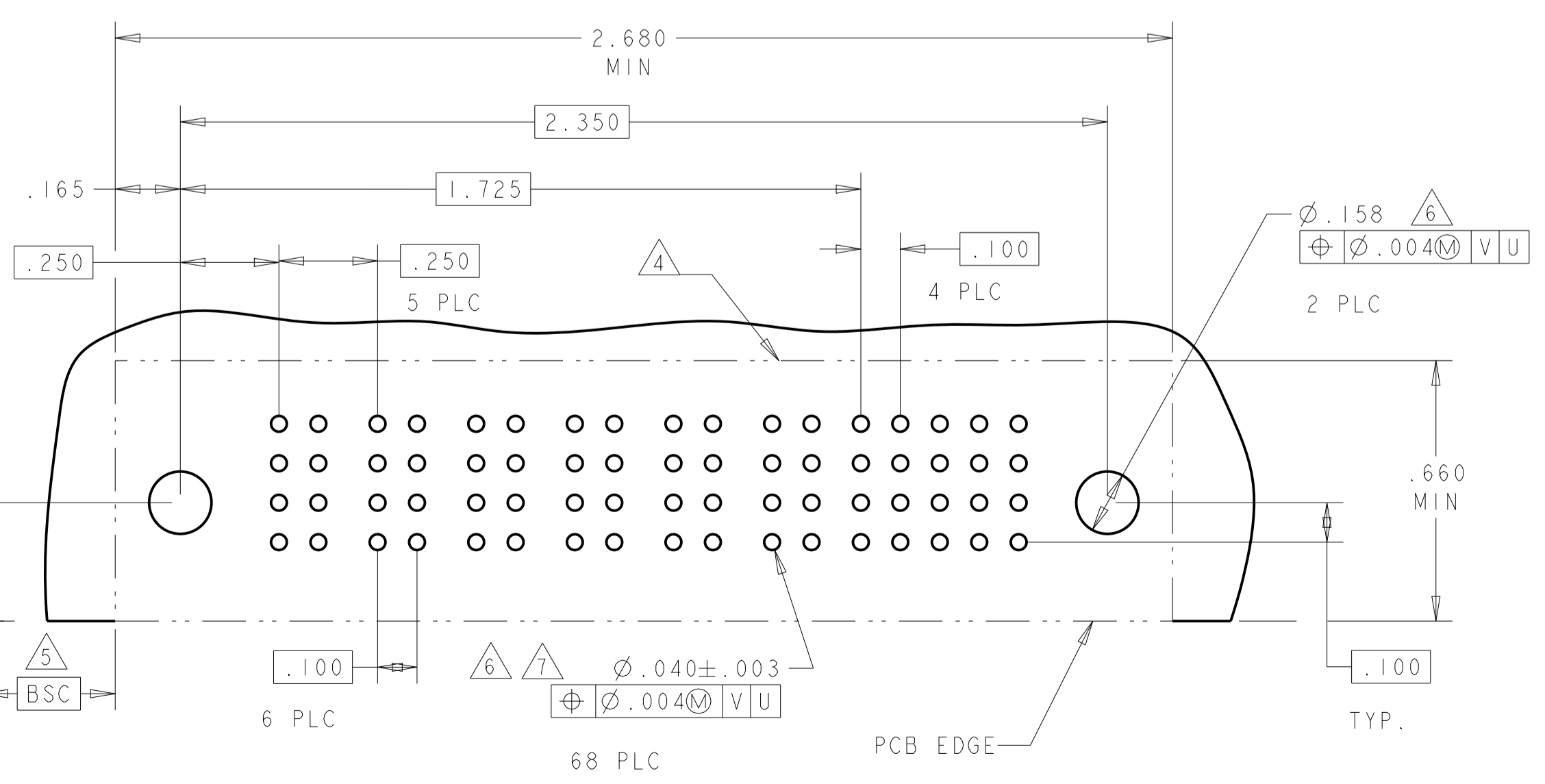

(B1) ADD SHEET 5 OF 6

THIS DRAWING IS A CONTROLLED DOCUMENT.		DMN: R. GRZYBOWSKI 24JAN05	TE Connectivity
DIMENSIONS: INCHES		CHK: M. PERCHERKE 24JAN05	
TOLERANCES UNLESS OTHERWISE SPECIFIED:		APVD: M. PERCHERKE	NAME: RIGHT ANGLE SOLDER HEADER ASSEMBLY MULTI-BEAM XL
0 PLC ±.01		PRODUCT SPEC: 108-1973	SIZE: A1
1 PLC ±.01		APPLICATION SPEC: 114-13038	CAGE CODE: 6450332
2 PLC ±.005		WEIGHT: -	RESTRICTED TO: -
3 PLC ±.002		CUSTOMER DRAWING	SCALE: 4:1 SHEET 6 OF 13 REV: H6
ANGLES ±.020			
FINISH: -			

LOC	DIST	REV	DATE	BY	APPV
ES	00				

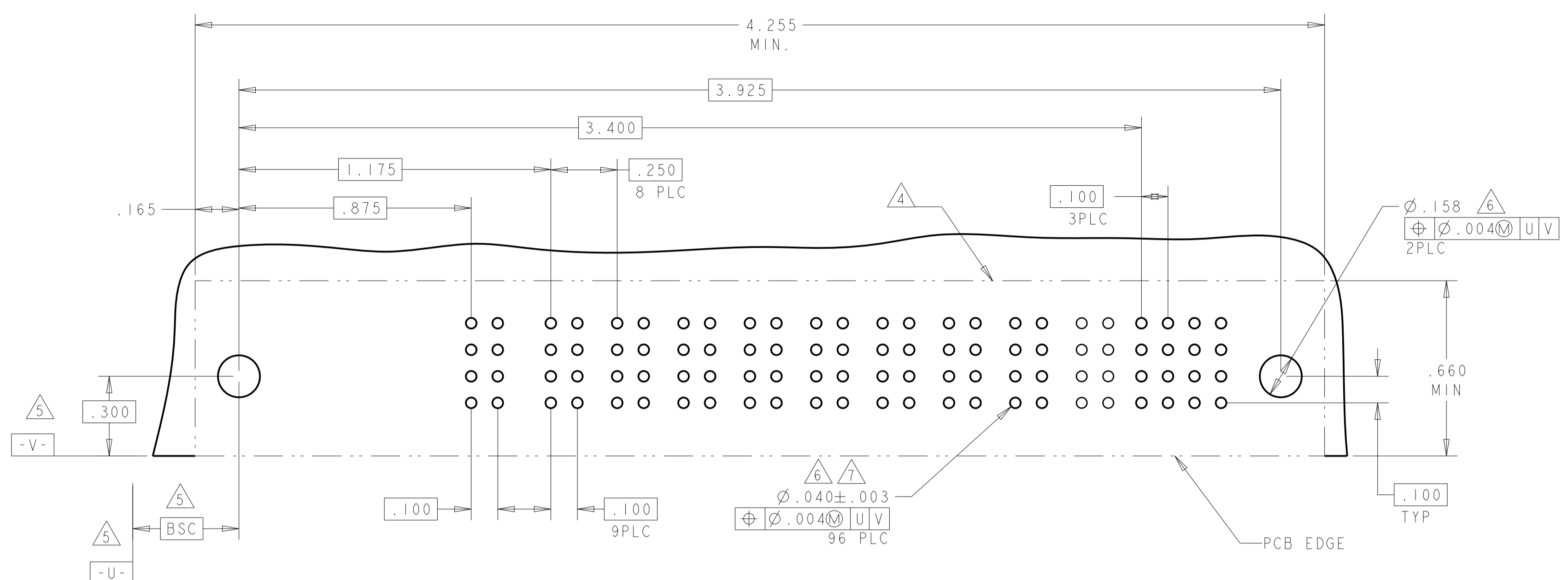

PART NUMBER	ROWS	POWER										SIGNAL						
		P1	P2	P3	P4	P5	P6	P7	P8	P9	P10	P11	P12	1	2	3	4	
1-6450332-8	D C B A																	
IACP + 9P + 16S																		

PART NUMBER	ROWS	POWER									SIGNAL							
		P1	P2	P3	P4	P5	P6	P7	P8	P9	1	2	3	4	5	6		
6450332-9	D C B A																	
3ACP + 6P + 24S																		

PART NUMBER	ROWS	POWER									SIGNAL							
		P1	P2	P3	P4	P5	P6	P7	P8	P9	1	2	3	4	5	6		
2-6450332-3	D C B A																	
3ACP + 6P + 24S																		

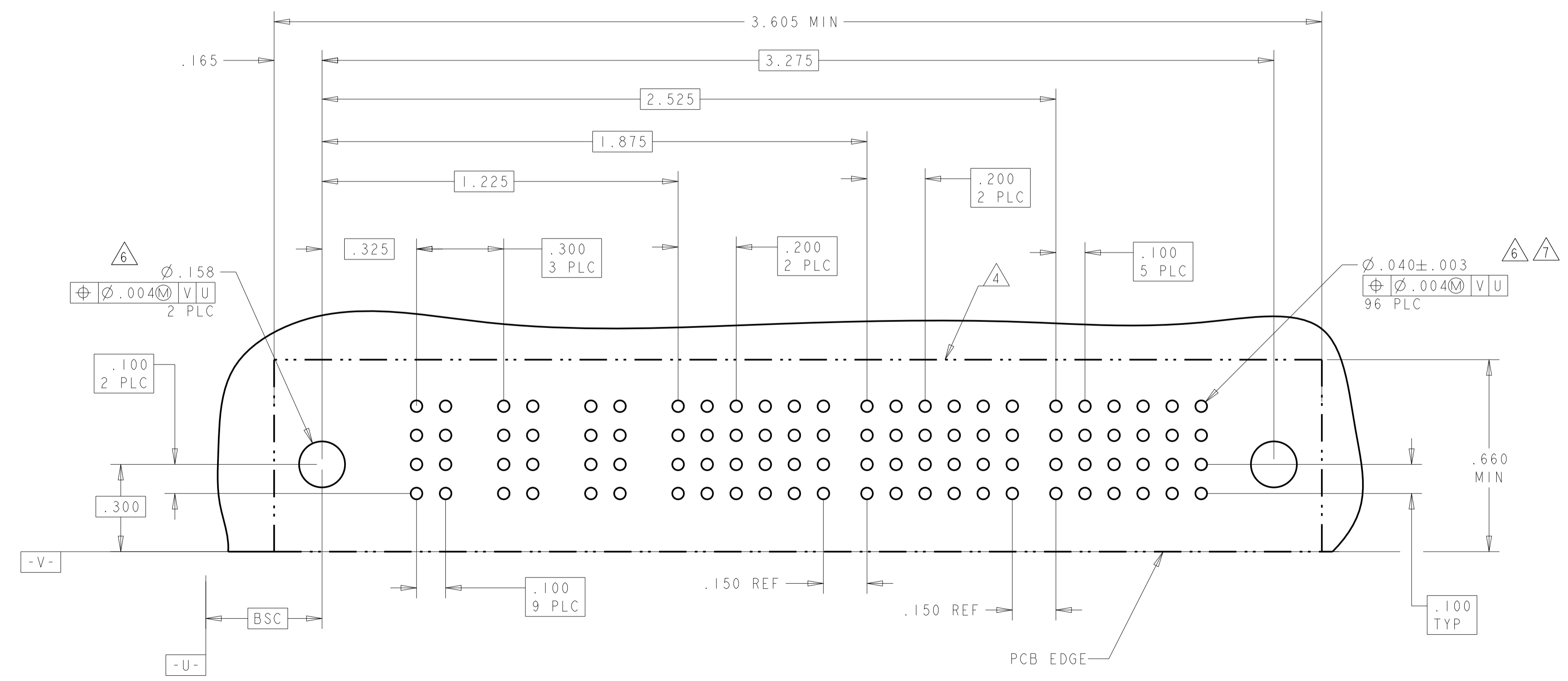
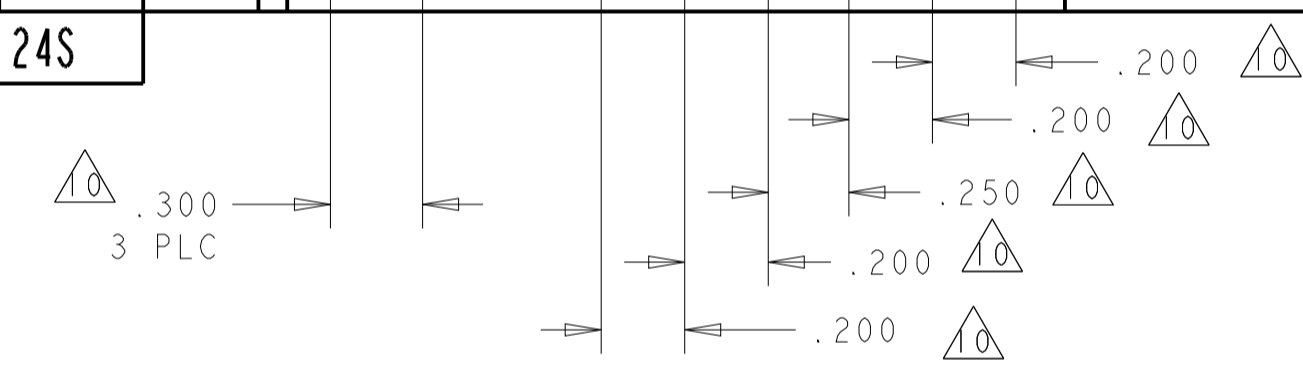

PART NUMBER 6450332-9 & 2-6450332-3 PCB LAYOUT

THIS DRAWING IS A CONTROLLED DOCUMENT.		OWN: R. GRZYBOWSKI 24JAN05	TE Connectivity
DIMENSIONS: INCHES		CHK: M. PERCHERKE 24JAN05	
TOLERANCES UNLESS OTHERWISE SPECIFIED:		APVD: M. PERCHERKE	NAME: RIGHT ANGLE SOLDER HEADER ASSEMBLY MULTI-BEAM XL
0 PLC ±.01 1 PLC ±.01 2 PLC ±.01 3 PLC ±.005 4 PLC ±.002 ANGLES ±.020		PRODUCT SPEC: 108-1973	SIZE: CAGE CODE DRAWING NO: A100779
MATERIAL: FINISH:		APPLICATION SPEC: 114-13038	RESTRICTED TO: C=6450332
		WEIGHT: CUSTOMER DRAWING	SCALE: 4:1 SHEET 7 OF 13 REV: H6

LOC	DIST	REVISIONS			
P	LTN	DESCRIPTION	DATE	DMN	APVD
ES	00	SEE SHEET 1			

PART NUMBER	ROWS	POWER					SIGNAL					
		P1	P2	P3	P4	P5	1	2	3	4	5	6
2-6450332-0	D C B A	PM	PM	PM	PM	PM	E	E	E	E	E	E
							K	F	F	F	F	F
							N	G	G	G	G	G
							H	H	H	H	H	S
5P + 24S												

PART NUMBER	ROWS	POWER		SIGNAL					
		P1	P2	1	2	3	4	5	6
6450332-8	D C B A	PM	PM	J	J	J	J	J	J
				K	F	K	K	K	K
				N	N	N	N	N	N
				S	S	S	S	S	S
2P + 24S									

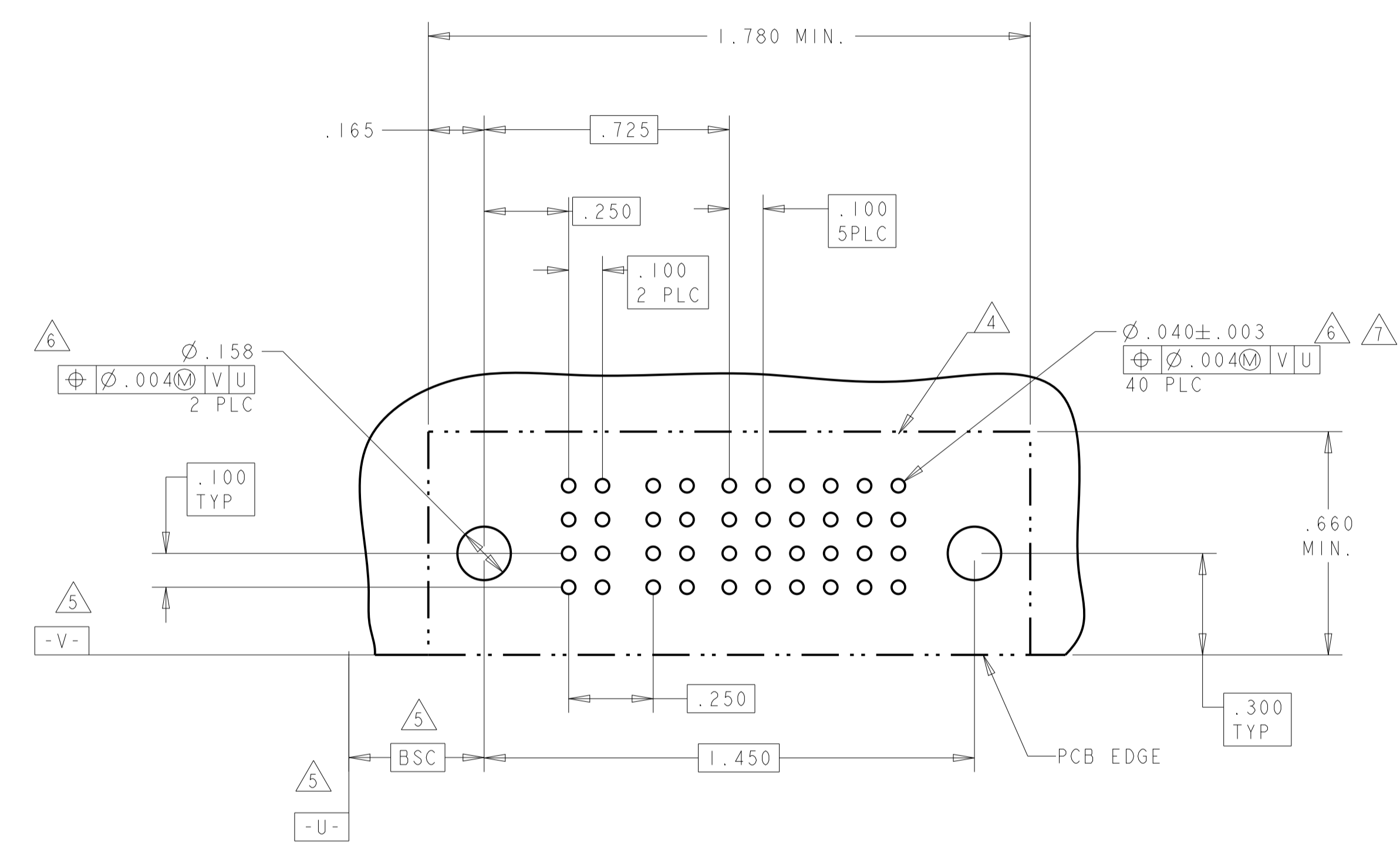
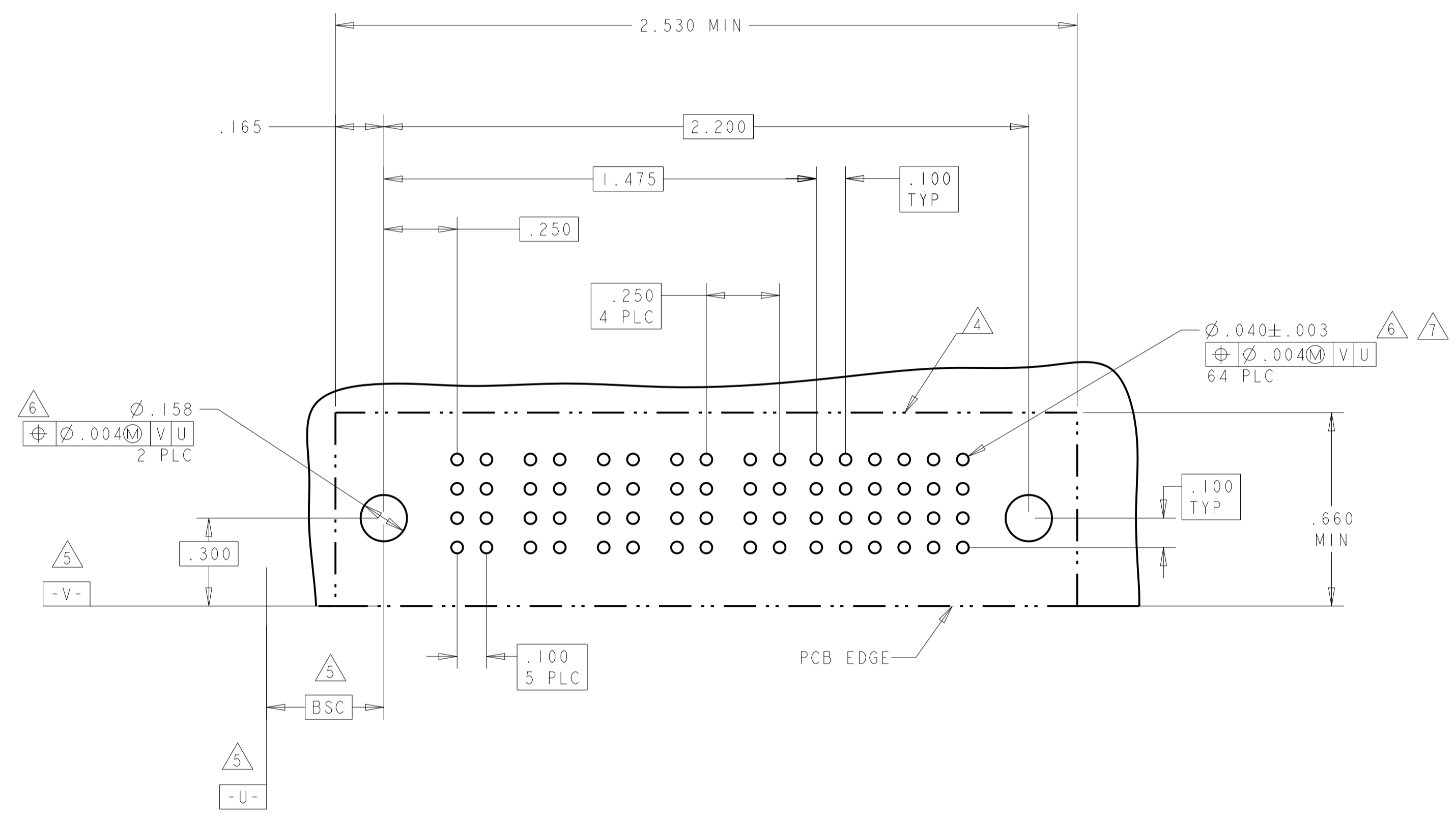

THIS DRAWING IS A CONTROLLED DOCUMENT.

DMN: R. GRZYBOWSKI 24JAN05  
CHK: M. PERCHERKE 24JAN05  
APVD: M. PERCHERKE

**STE** TE Connectivity

NAME: RIGHT ANGLE SOLDER HEADER ASSEMBLY MULTI-BEAM XL

PRODUCT SPEC: 108-1973  
APPLICATION SPEC: 114-13038

SIZE: A1  
CAGE CODE: 100779  
DRAWING NO: 6450332

RESTRICTED TO: -

CUSTOMER DRAWING

SCALE: 4:1 SHEET 8 OF 13 REV H6

DIMENSIONS: INCHES  
TOLERANCES UNLESS OTHERWISE SPECIFIED:  
0 PLC ±.01  
2 PLC ±.01  
3 PLC ±.01  
4 PLC ±.005  
5 PLC ±.0020  
ANGLES ±.2°

MATERIAL: -  
FINISH: -



LOC	DIST	REV	DATE	BY	APPV
ES	00				

PART NUMBER	ROWS	POWER								SIGNAL					
		P1	P2	P3	P4	P5	P6	P7	P8	1	2	3	4	5	6
2-6450332-4	D C B A	PM	PM	PM	PM	PM	PM	PM	PM	J	J	J	J	E	E
		PM	PM	PM	PM	PM	PM	PM	PM	K	K	K	K	F	F
		PM	PM	PM	PM	PM	PM	PM	PM	N	N	N	N	G	G
8P + 24S									S	S	S	S	H	H	

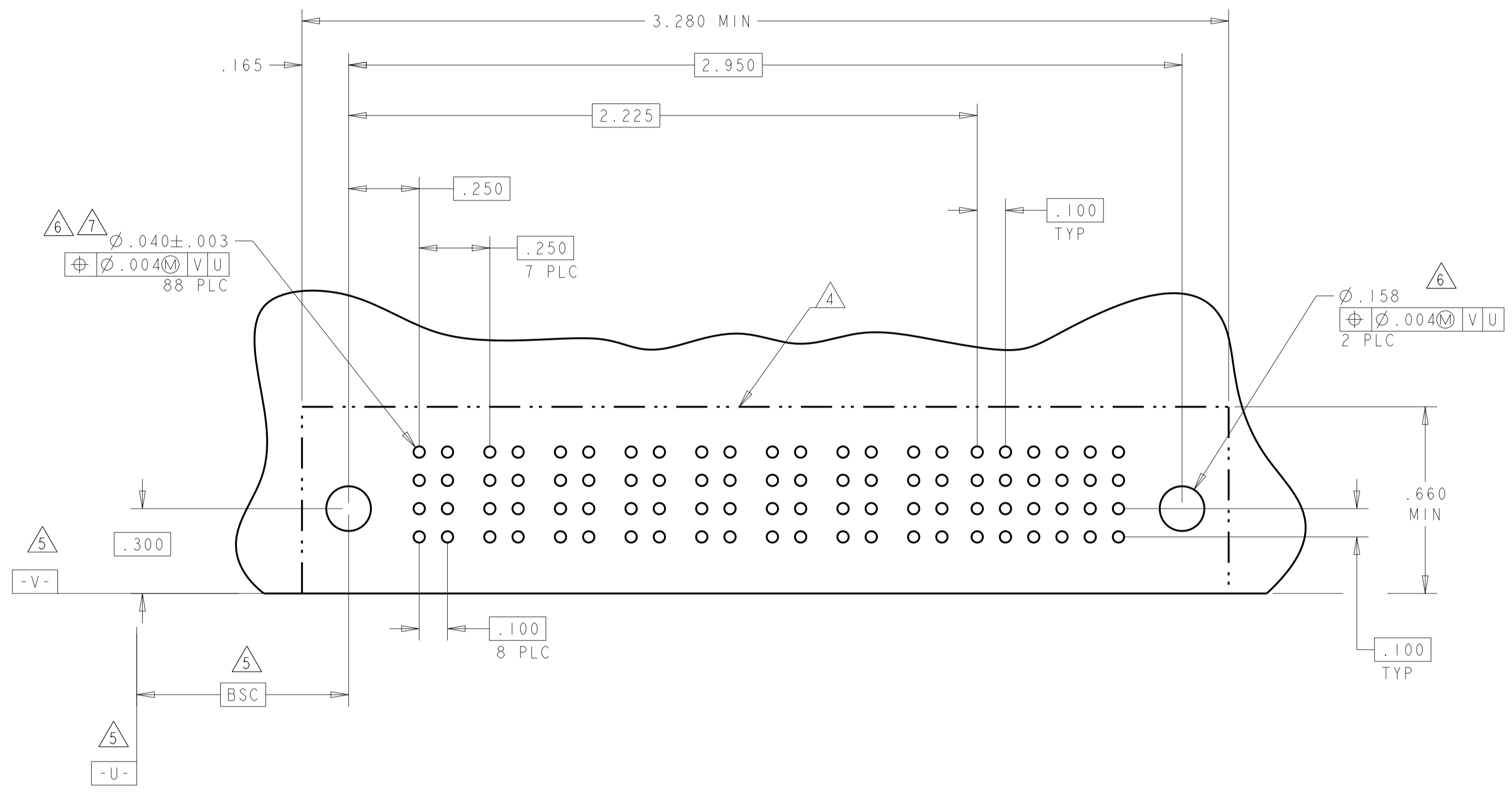

PART NUMBER	ROWS	POWER				SIGNAL					
		P1	P2	P3	P4	1	2	3	4	5	6
2-6450332-5	D C B A	PM	PM	PM	PM	E	E	E	E	E	E
		PM	PM	PM	PM	K	F	F	F	F	F
		PM	PM	PM	PM	N	G	G	G	G	G
4P + 24S						H	H	H	H	H	S

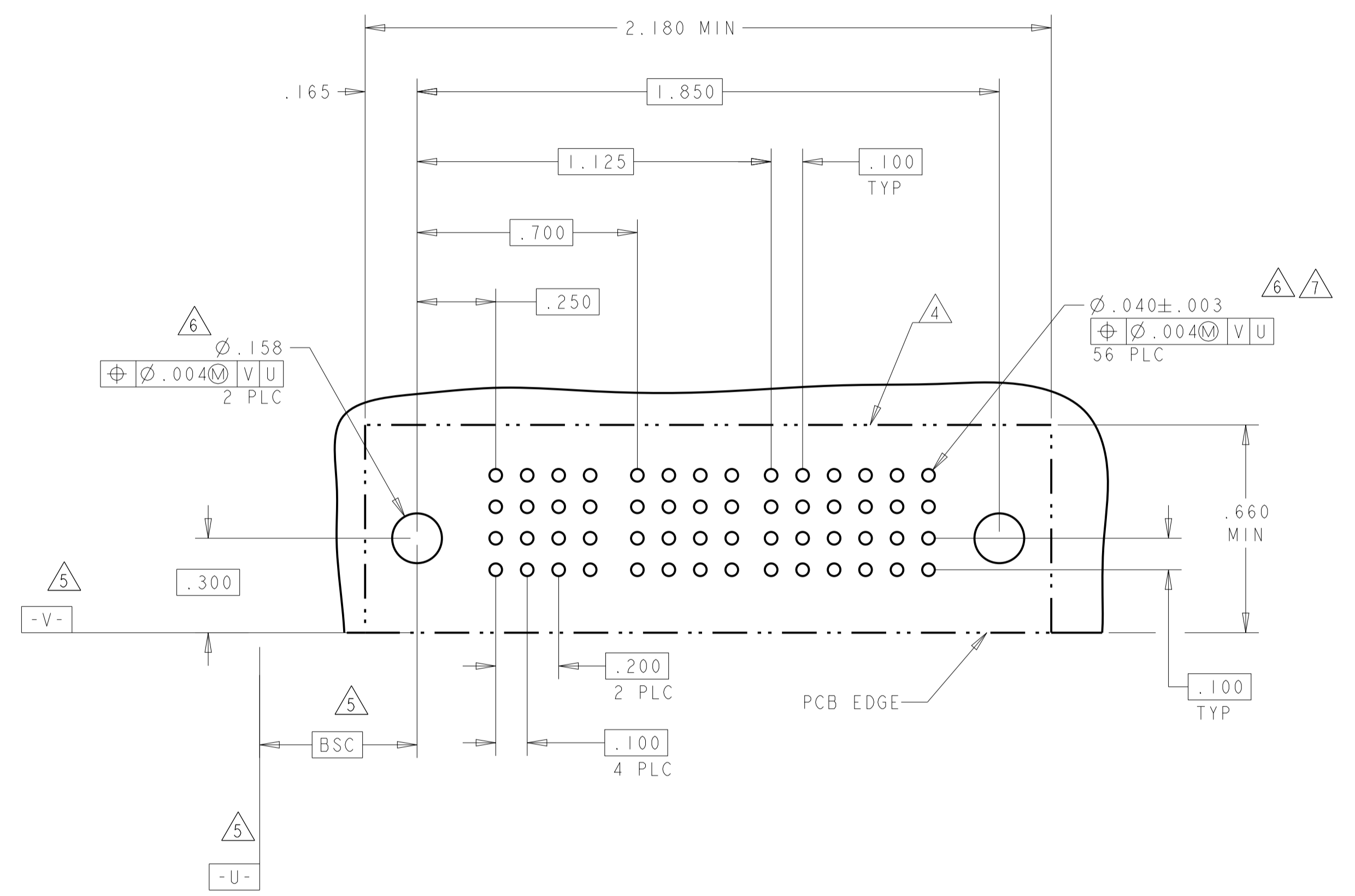

THIS DRAWING IS A CONTROLLED DOCUMENT. DWN: B. GRZYBOWSKI 24JAN05  
 CHK: M. PERCHERKE 24JAN05

**STE** TE Connectivity

NAME: RIGHT ANGLE SOLDER HEADER ASSEMBLY MULTI-BEAM XL

PRODUCT SPEC: 108-1973  
 APPLICATION SPEC: 114-13038

SIZE: A100779 C=6450332  
 WEIGHT: -

CUSTOMER DRAWING SCALE: 4:1 SHEET 9 OF 13 REV: H6

LOC	DIST	REVISIONS			
P	LTH	DESCRIPTION	DATE	DMN	APVD
ES	00	SEE SHEET 1	-	-	-

PART NUMBER	ROWS	POWER				SIGNAL				
		P1	P2	P3	P4	1	2	3	4	5
2-6450332-6	D	PM	PM	PM	PM	J	J	J	J	J
	C					K	K	K	K	K
	B					N	N	N	N	N
A	H	H	H	H	H					

4P + 20S

PART NUMBER	ROWS	POWER									SIGNAL					
		P1	P2	P3	P4	P5	P6	P7	P8	P9	1	2	3	4	5	6
2-6450332-8	D	PM	PM	PM	PM	PM	PM	PM	PM	PM	E	E	E	E	E	E
	C										K	F	F	F	F	F
	B										N	G	G	G	G	G
A	H	H	H	H	H	H	S									

3ACP + 6P + 24S

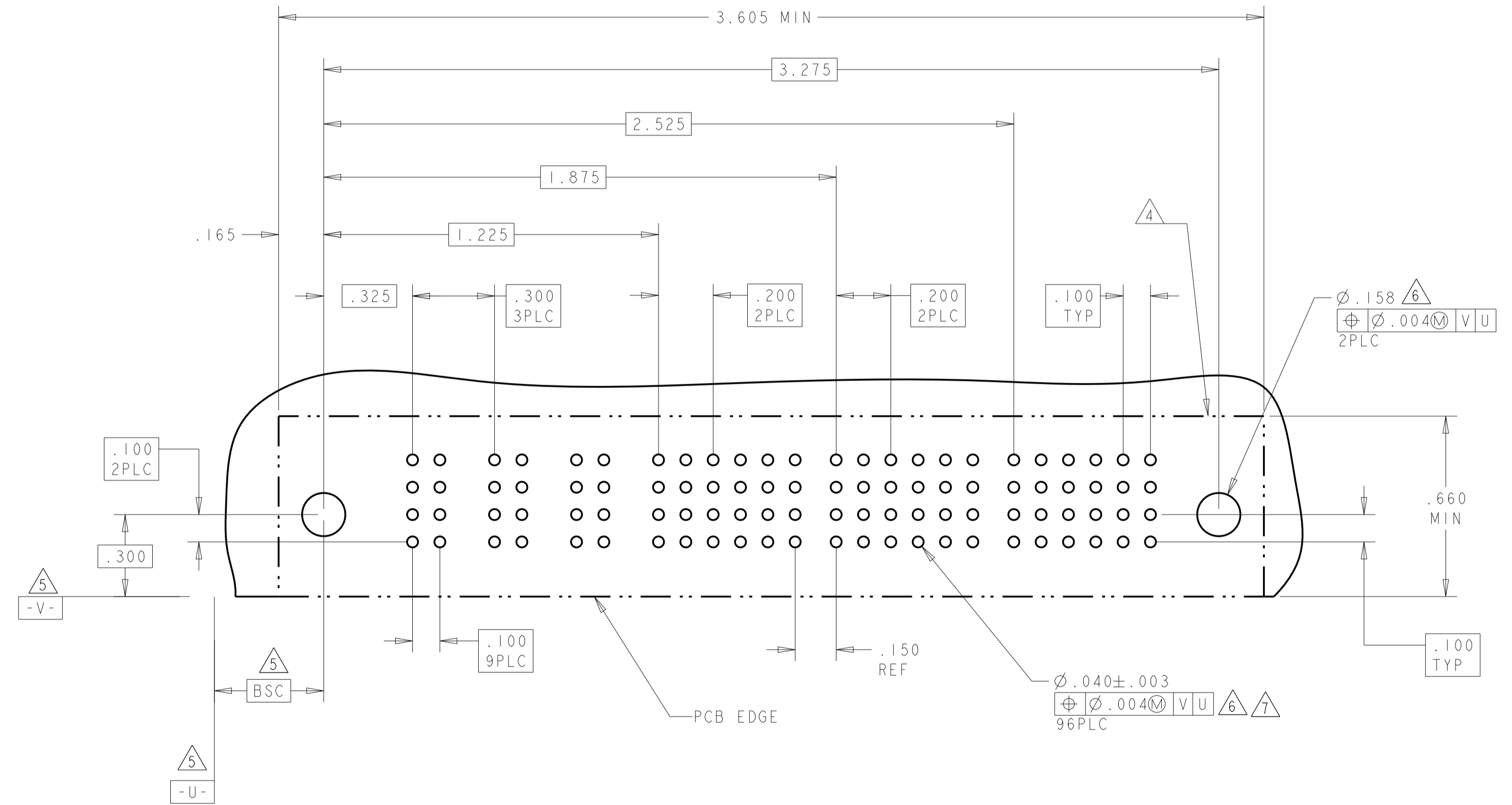
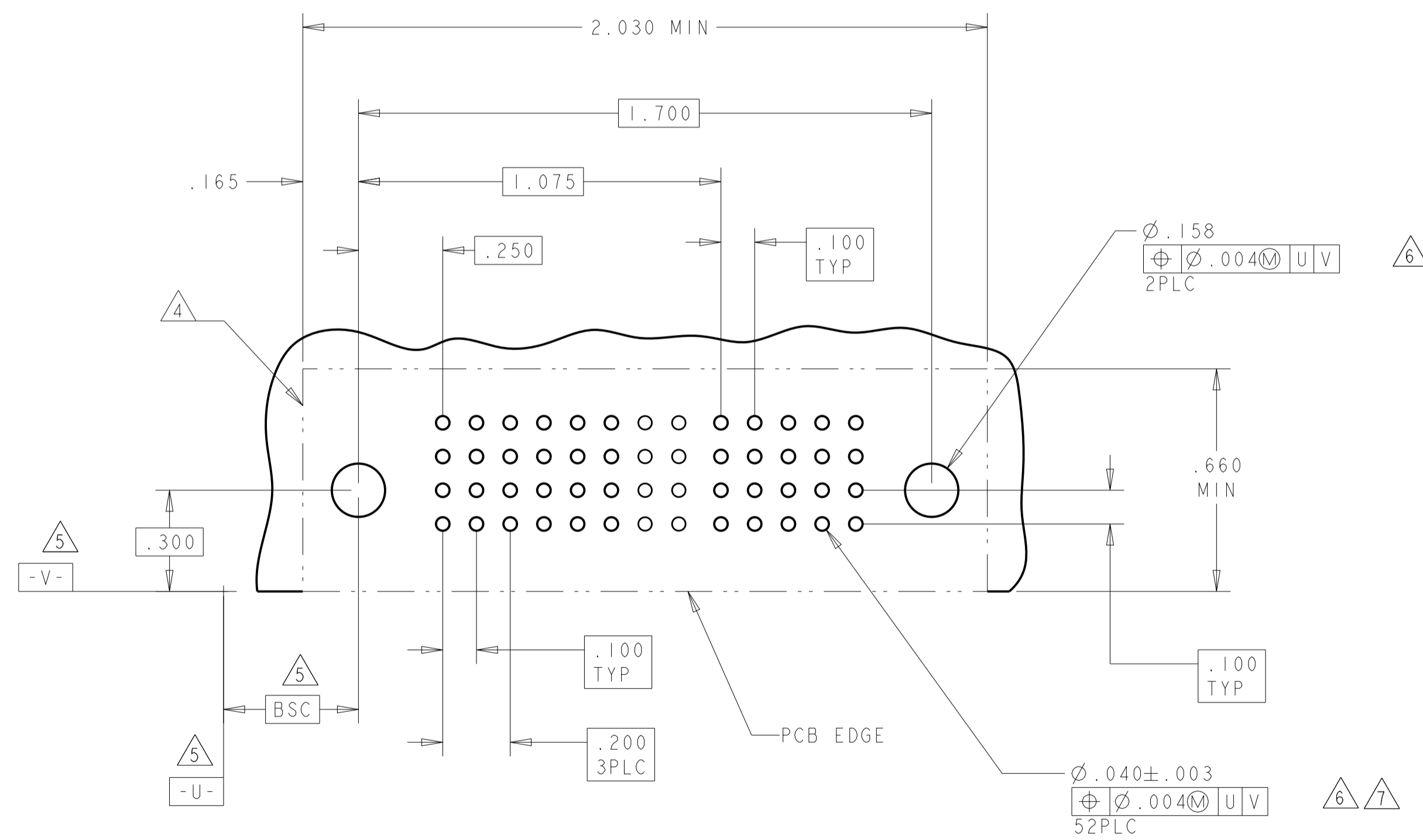

THIS DRAWING IS A CONTROLLED DOCUMENT.		DMN R. GRZYBOWSKI 24JAN05	TE Connectivity	
DIMENSIONS: INCHES	TOLERANCES UNLESS OTHERWISE SPECIFIED:	CHK M. PERCHERKE 24JAN05	NAME RIGHT ANGLE SOLDER HEADER ASSEMBLY MULTI-BEAM XL	
	0 PLC ± .01	APVD M. PERCHERKE	PRODUCT SPEC	
	1 PLC ± .01		108-1973	
	2 PLC ± .01		APPLICATION SPEC	
MATERIAL	FINISH	114-13038	SIZE A100779	CAGE CODE 6450332
CUSTOMER DRAWING		SCALE 4:1	SHEET 10	OF 13

LOC	DIST	REVISIONS					
		P	LTN	DESCRIPTION	DATE	DMN	APVD
ES	00	-	-	SEE SHEET 1	-	-	-

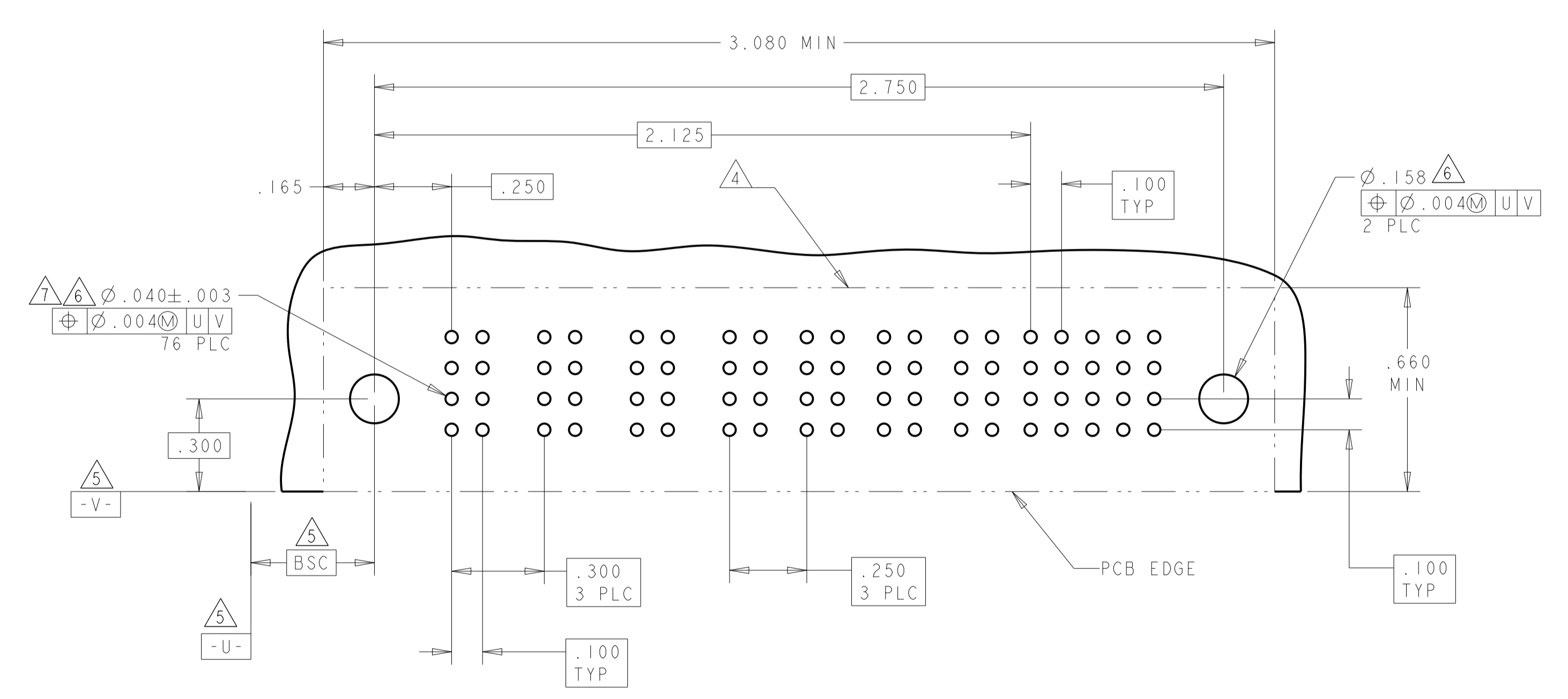
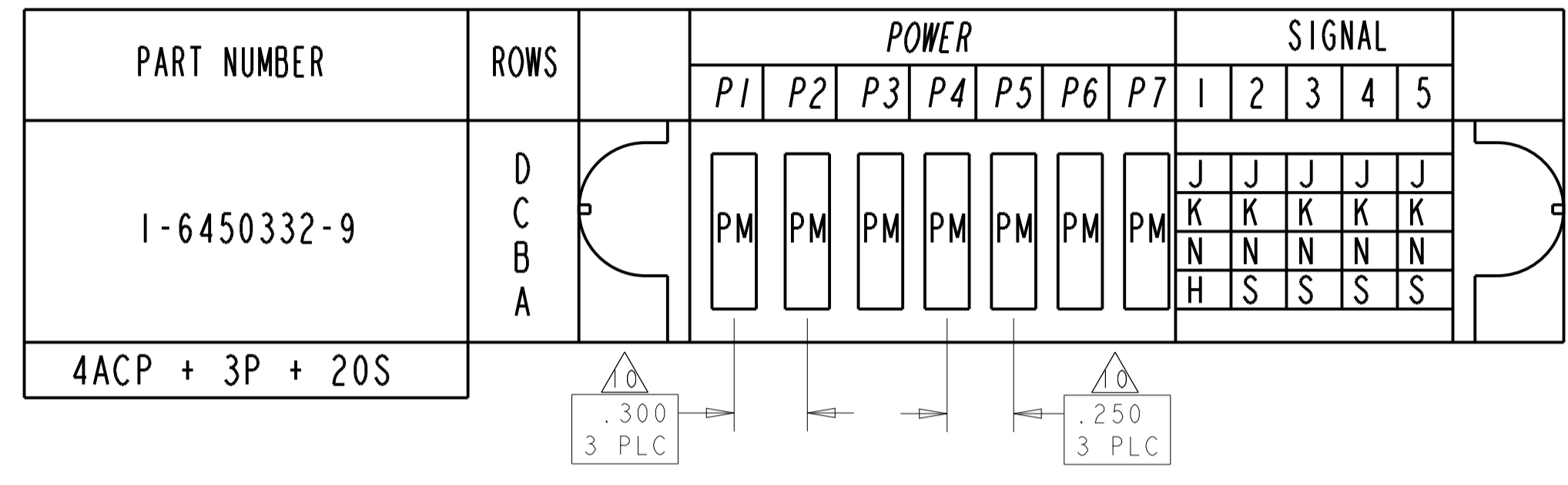

THIS DRAWING IS A CONTROLLED DOCUMENT.		DMN R. GRZYBOWSKI 24JAN05	TE Connectivity <b>RIGHT ANGLE SOLDER HEADER ASSEMBLY MULTI-BEAM XL</b>	
DIMENSIONS: INCHES		CHK M. PERCHERKE 24JAN05		
		TOLERANCES UNLESS OTHERWISE SPECIFIED:		PRODUCT SPEC
		APVD M. PERCHERKE		108-1973
				APPLICATION SPEC
				114-13038
				RESTRICTED TO
MATERIAL		FINISH		SIZE CAGE CODE DRAWING NO A100779C=6450332
				WEIGHT
				CUSTOMER DRAWING
				SCALE 4:1 SHEET 11 OF 13 REV H6

LOC		DIST		REVISIONS			
ES	00	P	LTM	DESCRIPTION	DATE	OWN	APVD
				SEE SHEET 1			

PART NUMBER	ROWS	POWER							SIGNAL						
		P1	P2	P3	P4	P5	P6	P7	P8	P9	1	2	3	4	5
3-6450332-0	D C B A	PM	PM	PM	PM	PM	PM	PM	PM	J	J	J	J	J	J
										K	K	K	K	K	K
										N	N	N	N	N	N
										S	S	S	S	S	S

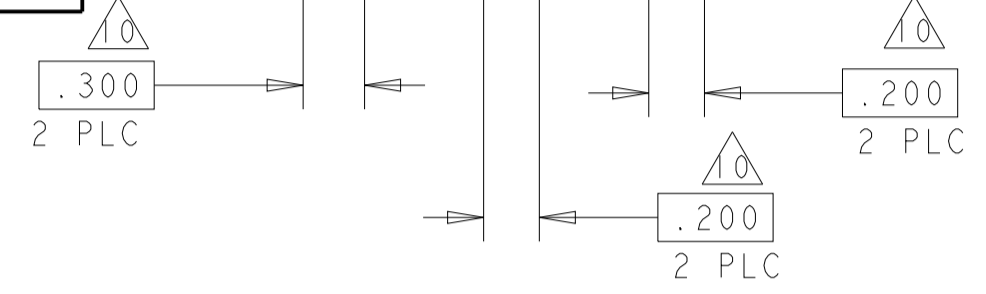

PART NUMBER	ROWS	POWER							SIGNAL					
		P1	P2	P3	P4	P5	P6	P7	1	2	3	4	5	6
3-6450332-1	D C B A	PM	PM	PM	PM	PM	PM	PM	J	J	J	J	J	J
									K	K	K	K	K	K
									N	N	N	N	N	N
									H	S	S	S	S	S

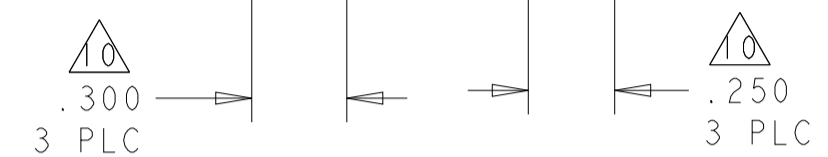

PART NUMBER	ROWS	POWER							SIGNAL					
		P1	P2	P3	P4	P5	P6	P7	1	2	3	4	5	6
3-6450332-3	D C B A	PM	PM	PM	PM	PM	PM	PM	E	E	J	J	J	E
									K	F	F	F	K	F
									N	G	G	G	N	G
									S	H	S	S	H	H

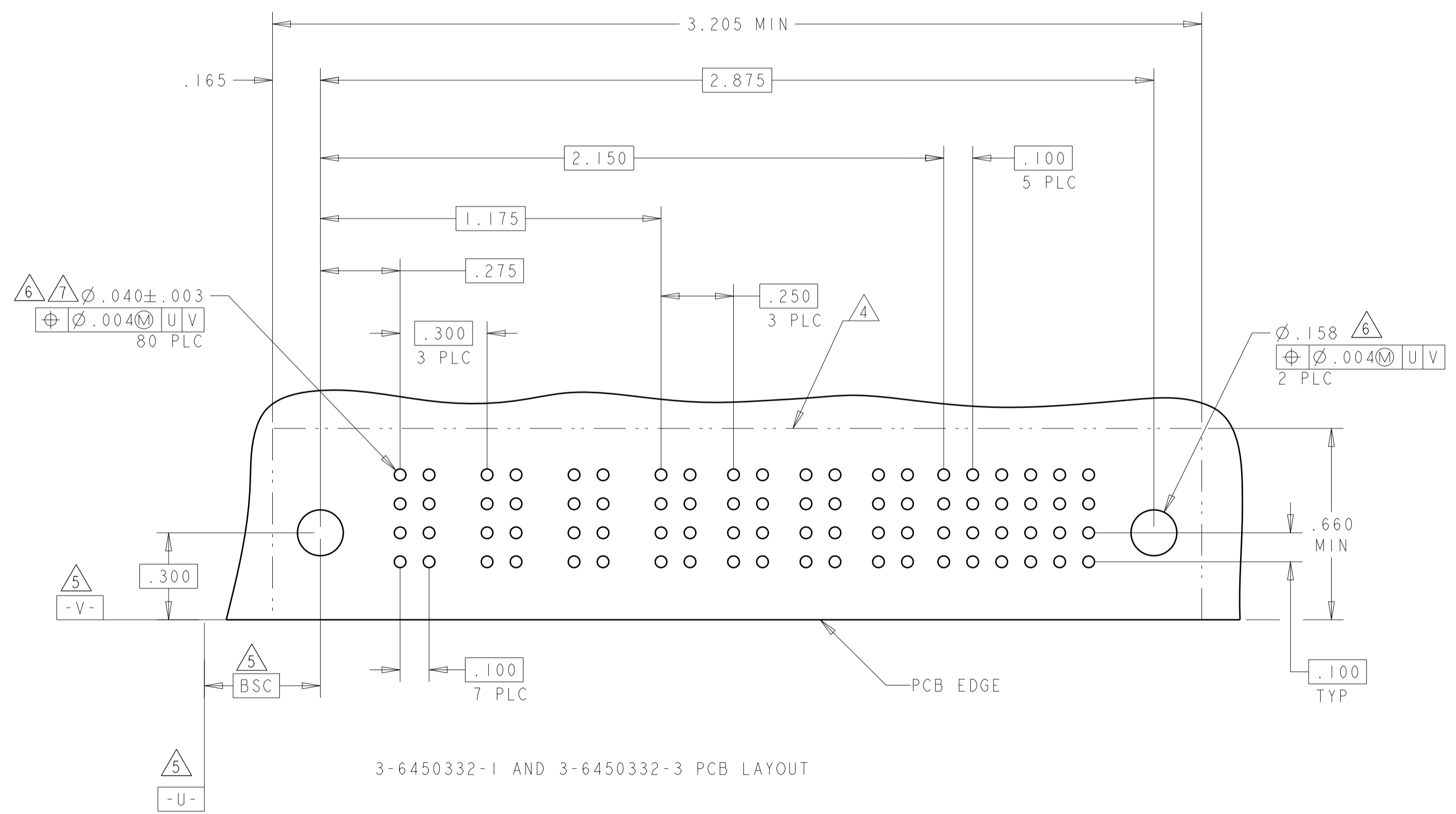
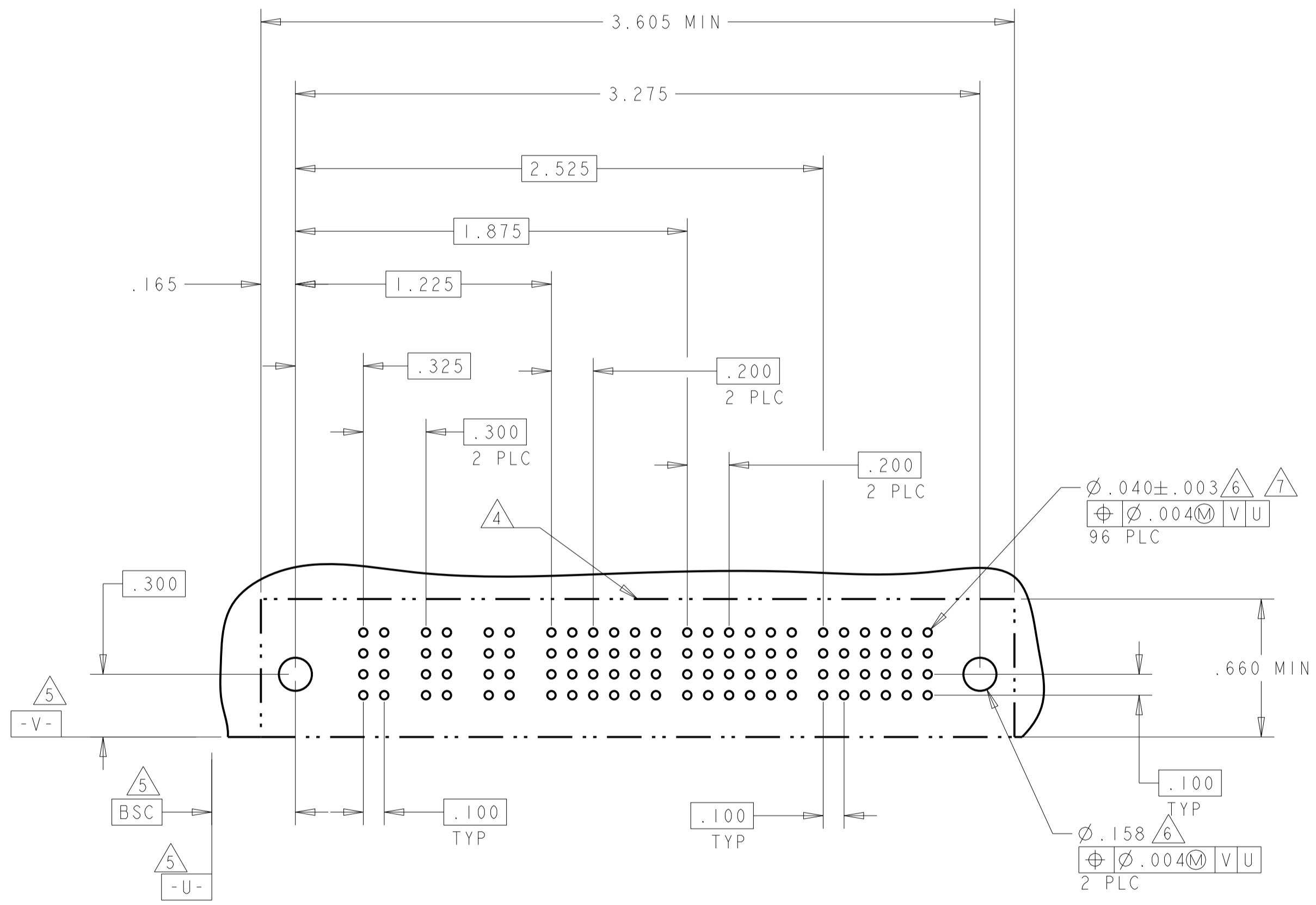
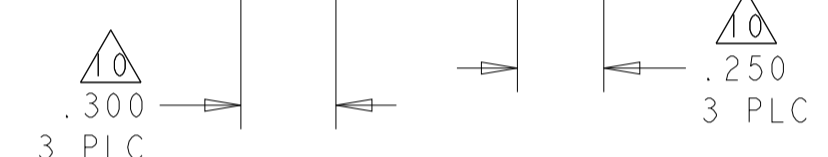

3-6450332-1 AND 3-6450332-3 PCB LAYOUT

THIS DRAWING IS A CONTROLLED DOCUMENT.

OWN: R. GRZYBOWSKI 24JAN05  
CHK: M. PERCHERKE 24JAN05  
APVD: M. PERCHERKE

TE Connectivity

NAME: RIGHT ANGLE SOLDER HEADER ASSEMBLY MULTI-BEAM XL

PRODUCT SPEC: 108-1973  
APPLICATION SPEC: 114-13038

SIZE: A100779 C=6450332  
SCALE: 4:1 SHEET 12 OF 13 REV: H6

CUSTOMER DRAWING

LOC		DIST		REVISIONS			
ES	00	P	LTN	DESCRIPTION	DATE	DWN	APVD
-	-	-	-	SEE SHEET 1	-	-	-

PART NUMBER	ROWS	POWER				SIGNAL		
		P1	P2	P3	P4	1	2	3
3-6450332-2	D C B A	PM	PM	PM	PM	J K N S	E F N S	J F N S
4P + 12S								

PART NUMBER	ROWS	POWER				SIGNAL					
		P1	P2	P3	P4	1	2	3	4	5	6
3-6450332-4	D C B A	PM	PM	PM	PM	E K N S	E F G H	J F G S	J F G S	J K N S	E F G H
4P + 24S											

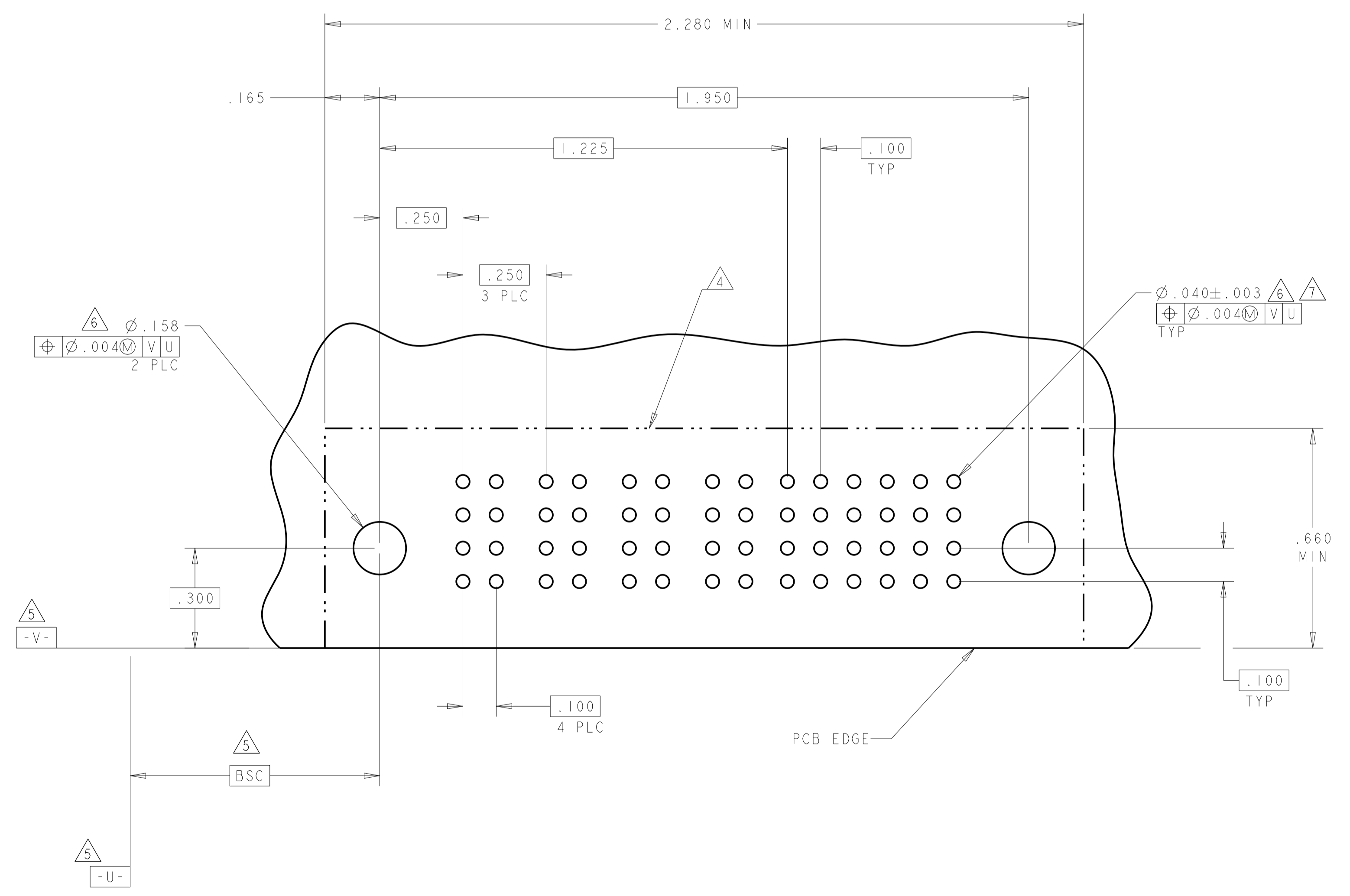
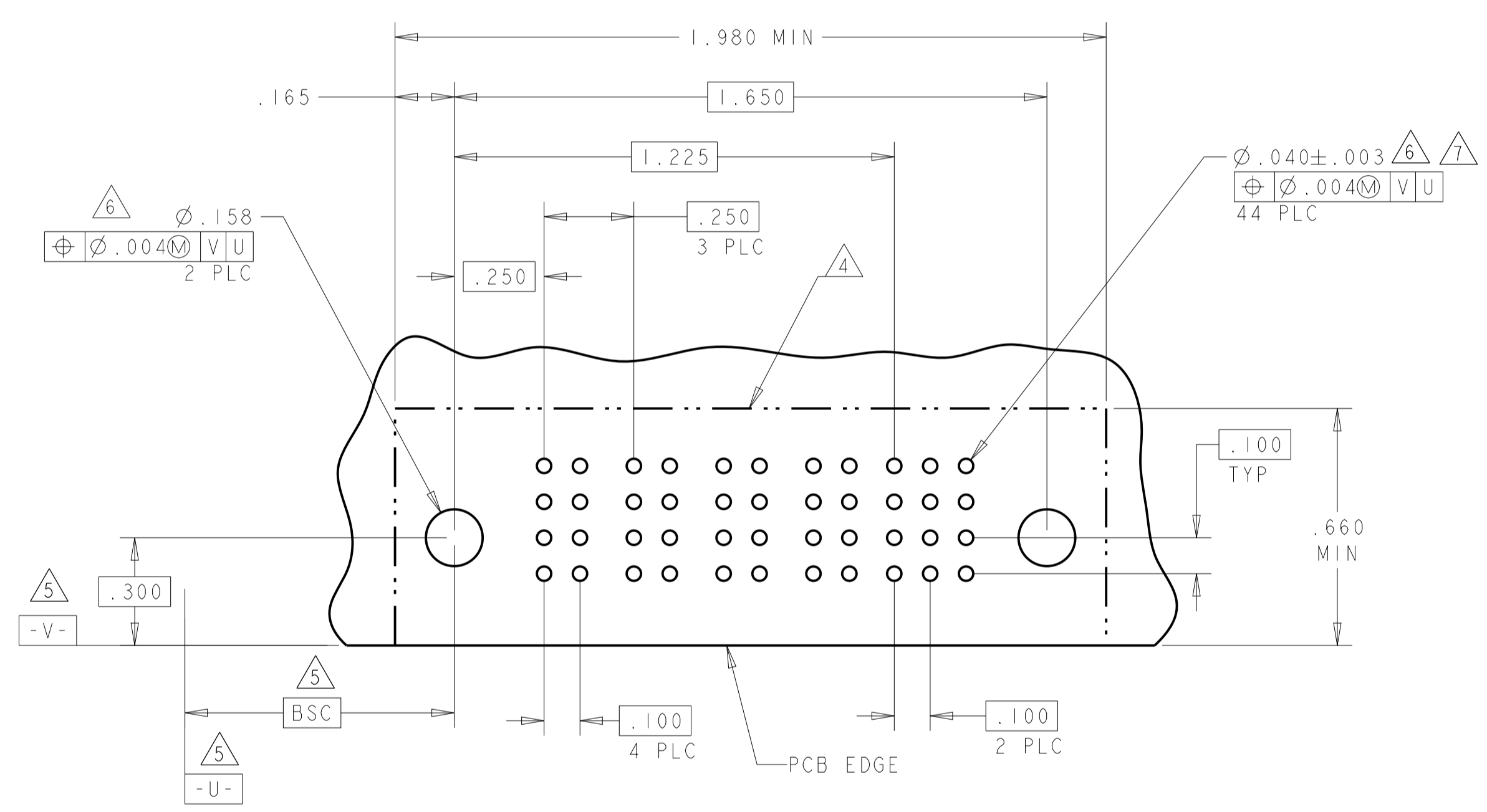

THIS DRAWING IS A CONTROLLED DOCUMENT.		DWN R. GRZYBOWSKI 24JAN05	TE Connectivity
DIMENSIONS: INCHES		CHK M. PERCHERKE 24JAN05	
TOLERANCES UNLESS OTHERWISE SPECIFIED: 0 PLC ±.01 1 PLC ±.01 2 PLC ±.01 3 PLC ±.005 4 PLC ±.0020 ANGLES ±.020		APVD M. PERCHERKE	NAME RIGHT ANGLE SOLDER HEADER ASSEMBLY MULTI-BEAM XL
MATERIAL		PRODUCT SPEC 108-1973	SIZE 114-13038
FINISH		APPLICATION SPEC	RESTRICTED TO
CUSTOMER DRAWING		WEIGHT	A100779C=6450332
		SCALE 4:1	SHEET 13 OF 13 REV H6

Компания «Life Electronics» занимается поставками электронных компонентов импортного и отечественного производства от производителей и со складов крупных дистрибьюторов Европы, Америки и Азии.

С конца 2013 года компания активно расширяет линейку поставок компонентов по направлению коаксиальный кабель, кварцевые генераторы и конденсаторы (керамические, пленочные, электролитические), за счёт заключения дистрибьюторских договоров

Мы предлагаем:

- Конкуренспособные цены и скидки постоянным клиентам.
- Специальные условия для постоянных клиентов.
- Подбор аналогов.
- Поставку компонентов в любых объемах, удовлетворяющих вашим потребностям.
- Приемлемые сроки поставки, возможна ускоренная поставка.
- Доставку товара в любую точку России и стран СНГ.
- Комплексную поставку.
- Работу по проектам и поставку образцов.
- Формирование склада под заказчика.
- Сертификаты соответствия на поставляемую продукцию (по желанию клиента).
- Тестирование поставляемой продукции.
- Поставку компонентов, требующих военную и космическую приемку.
- Входной контроль качества.
- Наличие сертификата ISO.

В составе нашей компании организован Конструкторский отдел, призванный помогать разработчикам, и инженерам.

Конструкторский отдел помогает осуществить:

- Регистрацию проекта у производителя компонентов.
- Техническую поддержку проекта.
- Защиту от снятия компонента с производства.
- Оценку стоимости проекта по компонентам.
- Изготовление тестовой платы монтаж и пусконаладочные работы.



Тел: +7 (812) 336 43 04 (многоканальный)

Email: [org@lifeelectronics.ru](mailto:org@lifeelectronics.ru)