

**ZXTPS718MC**

**20V PNP LOW SATURATION TRANSISTOR AND  
40V, 1A SCHOTTKY DIODE COMBINATION**

**Features and Benefits**

**PNP Transistor**

- $BV_{CEO} > -20V$
- $I_C = -3.5A$  Continuous Collector Current
- Low Saturation Voltage (-220mV max @ -1A)
- $R_{SAT} = 64m\Omega$  for a low equivalent On-Resistance
- $h_{FE}$  characterized up to -6A for high current gain hold up

**Schottky Diode**

- $BV_R > 40V$
- $I_{FAV} = 3A$  Average Peak Forward Current
- Low  $V_F < 500mV$  (@1A) for reduced power loss
- Fast switching due to Schottky barrier
- Low profile 0.8mm high package for thin applications
- $R_{\theta JA}$  efficient, 40% lower than SOT26
- 6mm<sup>2</sup> footprint, 50% smaller than TSOP6 and SOT26
- **Lead-Free, RoHS Compliant (Note 1)**
- **Halogen and Antimony Free. "Green" Device (Note 2)**
- **Qualified to AEC-Q101 Standards for High Reliability**

**Mechanical Data**

- Case: DFN3020B-8
- Case Material: Molded Plastic, "Green" Molding Component
- Terminals: Pre-Plated NiPdAu leadframe
- Nominal package height: 0.8mm
- UL Flammability Rating 94V-0
- Moisture Sensitivity: Level 1 per J-STD-020
- Weight: 0.013 grams (approximate)

**Applications**

- DC – DC Converters
- Charging circuits
- Mobile phones
- Motor control
- Portable applications

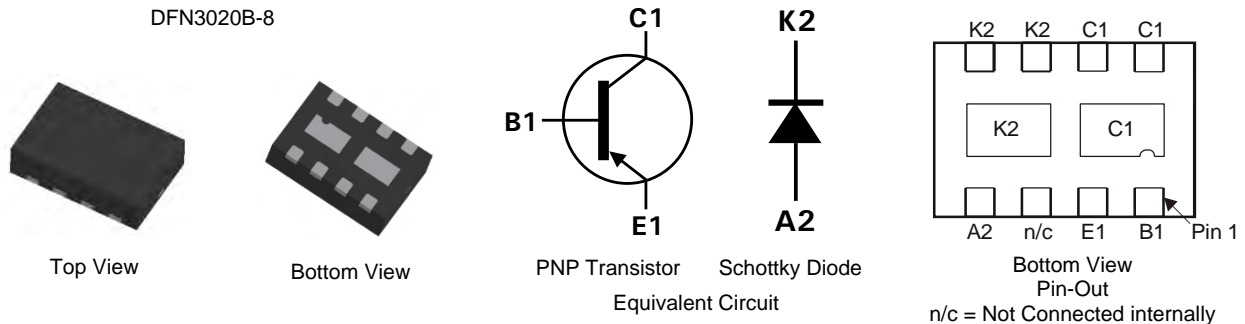

**Ordering Information** (Note 3)

Product	Marking	Reel size (inches)	Tape width (mm)	Quantity per reel
ZXTPS718MCTA	2S1	7	8	3000

- Notes:
1. No purposefully added lead.
  2. Diodes Inc's "Green" Policy can be found on our website <http://www.diodes.com>
  3. For packaging details, go to our website <http://www.diodes.com>

**Marking Information**



2S1 = Product type marking code  
Top view, dot denotes pin 1

**PNP - Maximum Ratings** @  $T_A = 25^\circ\text{C}$  unless otherwise specified

Parameter	Symbol	Limit	Unit
Collector-Base Voltage	$V_{CBO}$	-25	V
Collector-Emitter Voltage	$V_{CEO}$	-20	
Emitter-Base Voltage	$V_{EBO}$	-7	
Peak Pulse Current	$I_{CM}$	-6	A
Continuous Collector Current	(Notes 4 and 7)	-3.5	
	(Notes 5 and 7)	-3.9	
Base Current	$I_B$	-1	

**PNP - Thermal Characteristics** @  $T_A = 25^\circ\text{C}$  unless otherwise specified

Characteristic	Symbol	Value	Unit
Power Dissipation Linear Derating Factor	$P_D$	1.5	W mW/°C
		12	
		2.45	
		19.6	
		1.13	
Thermal Resistance, Junction to Ambient	$R_{\theta JA}$	8	°C/W
		1.7	
		13.6	
		83.3	
		51.0	
Thermal Resistance, Junction to Lead	$R_{\theta JL}$	111	°C/W
		73.5	
		17.1	
Operating and Storage Temperature Range	$T_J, T_{STG}$	-55 to +150	°C

- Notes:
4. For a dual device surface mounted on 28mm x 28mm (8cm<sup>2</sup>) FR4 PCB with high coverage of single sided 2 oz copper, in still air conditions; the device is measured when operating in a steady-state condition. The heatsink is split in half with the exposed collector and cathode pads connected to each half.
  5. Same as note (4), except the device is measured at  $t < 5$  sec.
  6. Same as note (4), except the device is surface mounted on 31mm x 31mm (10cm<sup>2</sup>) FR4 PCB with high coverage of single sided 1oz copper.
  7. For a dual device with one active die.
  8. For dual device with 2 active die running at equal power.
  9. Thermal resistance from junction to solder-point (on the exposed collector pad).

**PNP - Thermal Characteristics**

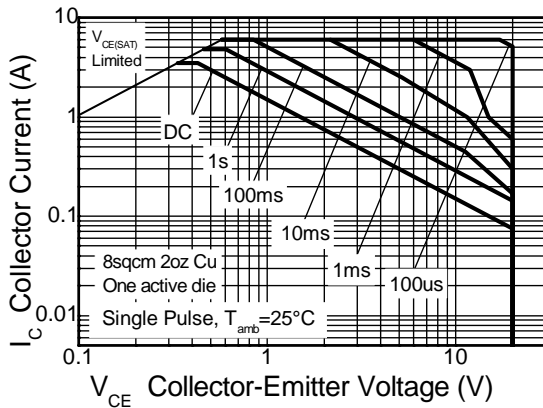

**Safe Operating Area**

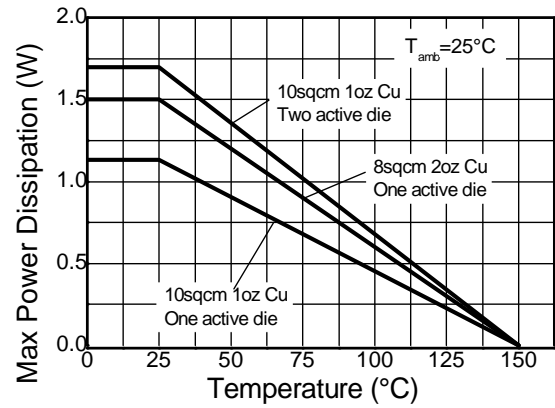

**Derating Curve**

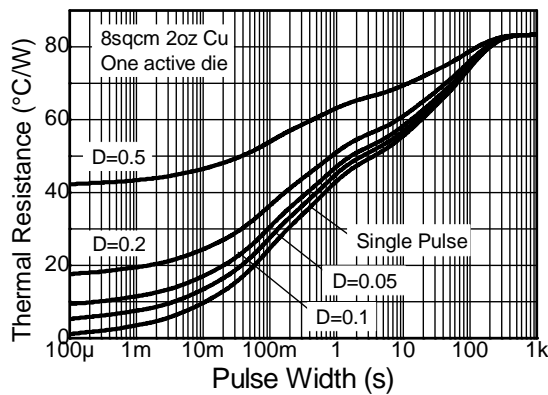

**Transient Thermal Impedance**

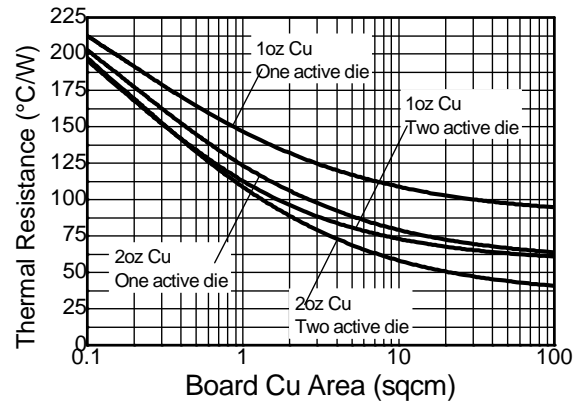

**Thermal Resistance v Board Area**

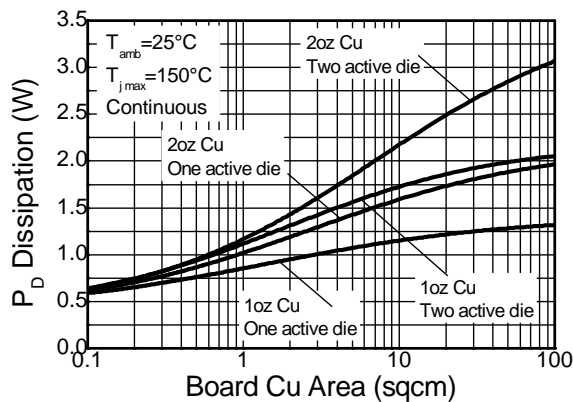

**Power Dissipation v Board Area**

**Schottky - Maximum Ratings** @  $T_A = 25^\circ\text{C}$  unless otherwise specified

Parameter	Symbol	Limit	Unit
Continuous Reverse Voltage	$V_R$	40	V
Continuous Forward Current	$I_F$	1.85	A
Repetitive Peak Forward Current	$I_{FRM}$	3	
Non-Repetitive Peak Forward Surge Current		$t \leq 100\mu\text{s}$	
	$t \leq 10\text{ms}$	7	

**Schottky - Thermal Characteristics** @  $T_A = 25^\circ\text{C}$  unless otherwise specified

Characteristic	Symbol	Value	Unit
Power Dissipation Linear Derating Factor	$P_D$	1.2	W mW/ $^\circ\text{C}$
		12	
		2	
		20	
Thermal Resistance, Junction to Ambient	$R_{\theta JA}$	0.9	$^\circ\text{C/W}$
		9	
		1.36	
		13.6	
Thermal Resistance, Junction to Lead	$R_{\theta JL}$	83.3	$^\circ\text{C/W}$
		51.0	
		111	
		73.5	
Storage Temperature Range	$T_{STG}$	-55 to +150	$^\circ\text{C}$
Maximum Junction Temperature	$T_J$	125	

- Notes:
10. For a dual device surface mounted on 28mm x 28mm (8cm<sup>2</sup>) FR4 PCB with high coverage of single sided 2 oz copper, in still air conditions; the device is measured when operating in a steady-state condition. The heatsink is split in half with the exposed cathode and collector pads connected to each half.
  11. Same as note (10), except the device is measured at  $t < 5$  sec.
  12. Same as note (10), except the device is surface mounted on 31mm x 31mm (10cm<sup>2</sup>) FR4 PCB with high coverage of single sided 1oz copper.
  13. For a dual device with one active die.
  14. For dual device with 2 active die running at equal power.
  15. Thermal resistance from junction to solder-point (on the exposed cathode pad).

**Schottky - Thermal Characteristics**

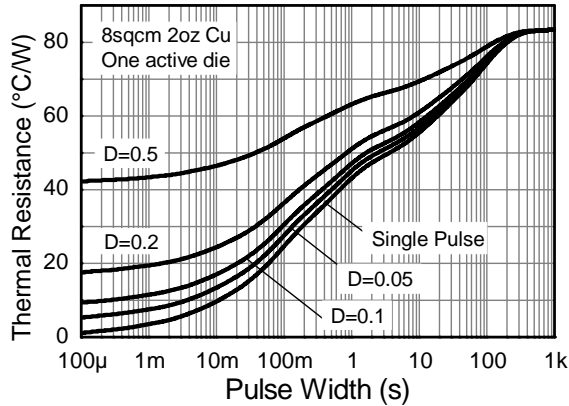

**Transient Thermal Impedance**

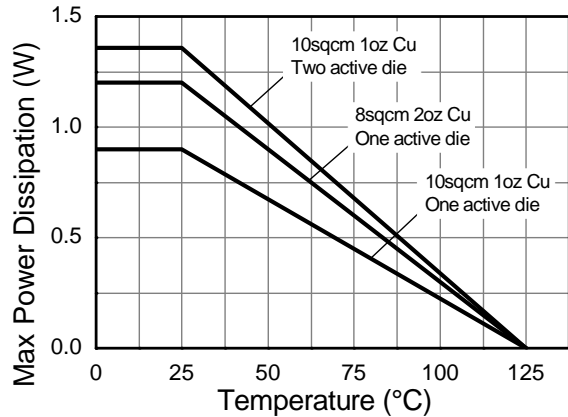

**Derating Curve**

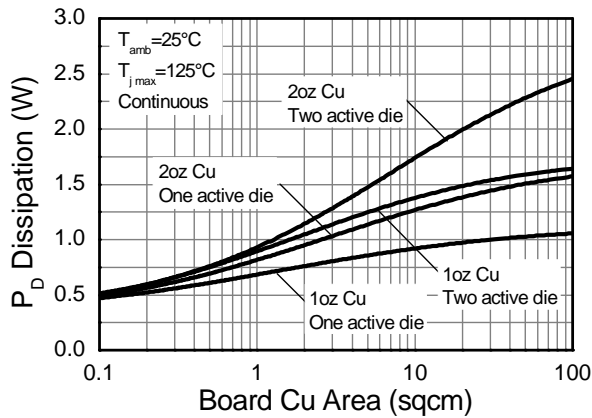

**Power Dissipation v Board Area**

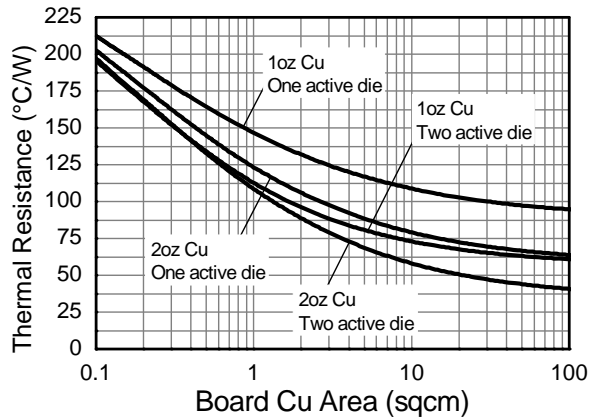

**Thermal Resistance v Board Area**

**PNP - Electrical Characteristics** @ $T_A = 25^\circ\text{C}$  unless otherwise specified

Characteristic	Symbol	Min	Typ	Max	Unit	Test Condition
Collector-Base Breakdown Voltage	$BV_{CBO}$	-25	-35	-	V	$I_C = -100\mu\text{A}$
Collector-Emitter Breakdown Voltage (Note 16)	$BV_{CEO}$	-20	-25	-	V	$I_C = -10\text{mA}$
Emitter-Base Breakdown Voltage	$BV_{EBO}$	-7	-8.5	-	V	$I_E = -100\mu\text{A}$
Collector Cutoff Current	$I_{CBO}$	-	-	-100	nA	$V_{CB} = -20\text{V}$
Emitter Cutoff Current	$I_{EBO}$	-	-	-100	nA	$V_{EB} = -6\text{V}$
Collector Emitter Cutoff Current	$I_{CES}$	-	-	-100	nA	$V_{CES} = -16\text{V}$
Static Forward Current Transfer Ratio (Note 16)	$h_{FE}$	300	475	-	-	$I_C = -10\text{mA}, V_{CE} = -2\text{V}$
		300	450	-		$I_C = -100\text{mA}, V_{CE} = -2\text{V}$
		150	230	-		$I_C = -2\text{A}, V_{CE} = -2\text{V}$
		15	30	-		$I_C = -6\text{A}, V_{CE} = -2\text{V}$
Collector-Emitter Saturation Voltage (Note 16)	$V_{CE(sat)}$	-	-19	-30	mV	$I_C = -0.1\text{A}, I_B = -10\text{mA}$
		-	-170	-220		$I_C = -1\text{A}, I_B = -20\text{mA}$
		-	-190	-250		$I_C = -1.5\text{A}, I_B = -50\text{mA}$
		-	-240	-350		$I_C = -2.5\text{A}, I_B = -150\text{mA}$
		-	-225	-300		$I_C = -3.5\text{A}, I_B = -350\text{mA}$
Base-Emitter Turn-On Voltage (Note 16)	$V_{BE(on)}$	-	-0.87	-0.95	V	$I_C = -3.5\text{A}, V_{CE} = -2\text{V}$
Base-Emitter Saturation Voltage (Note 16)	$V_{BE(sat)}$	-	-1.10	-1.12	V	$I_C = -3.5\text{A}, I_B = -350\text{mA}$
Output Capacitance	$C_{obo}$	-	21	30	pF	$V_{CB} = -10\text{V}, f = 1\text{MHz}$
Transition Frequency	$f_T$	150	180	-	MHz	$V_{CE} = -10\text{V}, I_C = -50\text{mA}, f = 100\text{MHz}$
Turn-on Time	$t_{on}$	-	40	-	Ns	$V_{CC} = -10\text{V}, I_C = -1\text{A}$
Turn-off Time	$t_{off}$	-	670	-	Ns	$I_{B1} = I_{B2} = -50\text{mA}$

**Schottky - Electrical Characteristics** @ $T_A = 25^\circ\text{C}$  unless otherwise specified

Characteristic	Symbol	Min	Typ	Max	Unit	Test Condition
Reverse Breakdown Voltage	$BV_R$	40	60	-	V	$I_R = -300\mu\text{A}$
Forward Voltage (Note 16)	$V_F$	-	240	270	mV	$I_F = 50\text{mA}$
		-	265	290		$I_F = 100\text{mA}$
		-	305	340		$I_F = 250\text{mA}$
		-	355	400		$I_F = 500\text{mA}$
		-	390	450		$I_F = 750\text{mA}$
		-	425	500		$I_F = 1000\text{mA}$
		-	495	600		$I_F = 1500\text{mA}$
		-	420	-		$I_F = 1000\text{mA}, T_A = 100^\circ\text{C}$
Reverse Current	$I_R$	-	50	100	$\mu\text{A}$	$V_R = 30\text{V}$
Diode Capacitance	$C_D$	-	25	-	pF	$V_R = 25\text{V}, f = 1\text{MHz}$
Reverse Recovery Time	$t_{rr}$	-	12	-	Ns	switched from $I_F = 500\text{mA}$ to $I_R = 500\text{mA}$ Measured at $I_R = 50\text{mA}$

Notes: 16. Measured under pulsed conditions. Pulse width  $\leq 300\mu\text{s}$ . Duty cycle  $\leq 2\%$ .

**PNP - Typical Electrical Characteristics**

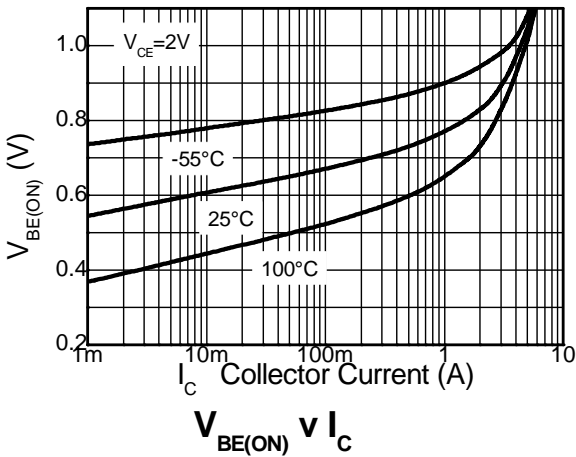
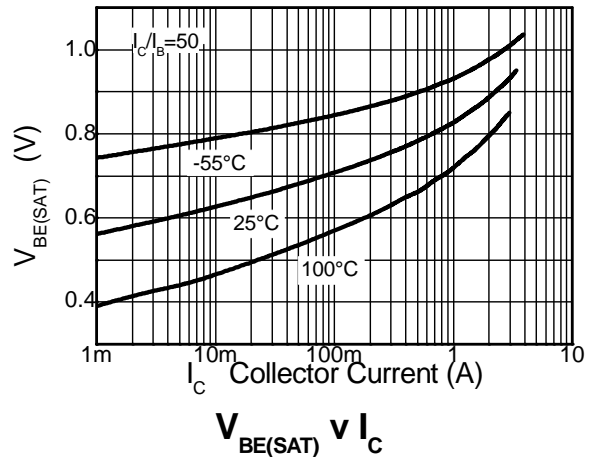
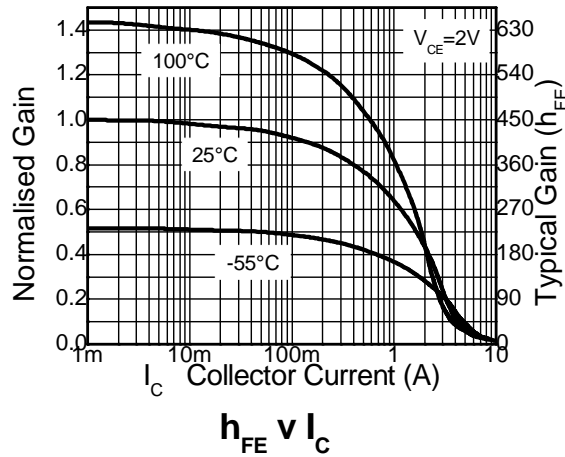
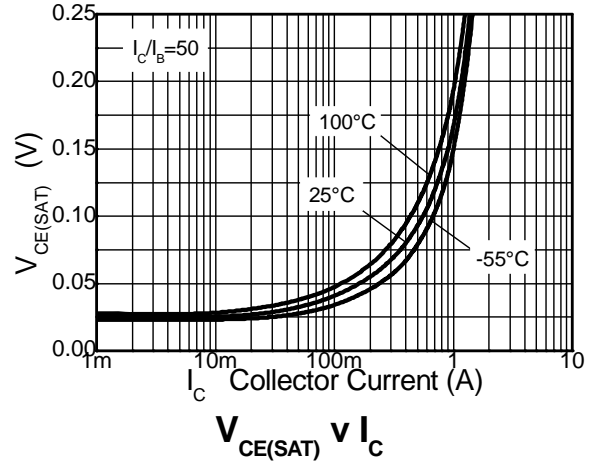
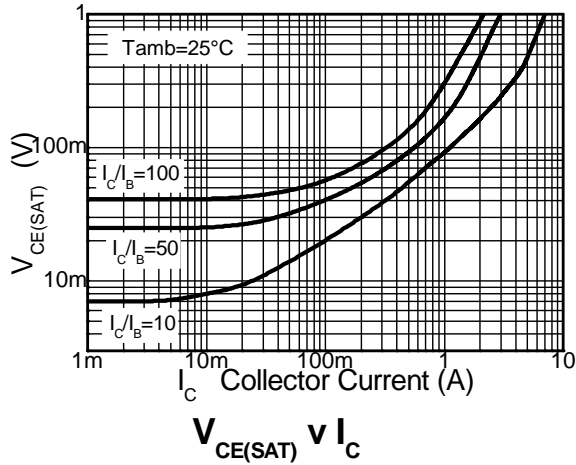

**Schottky - Typical Electrical Characteristics**

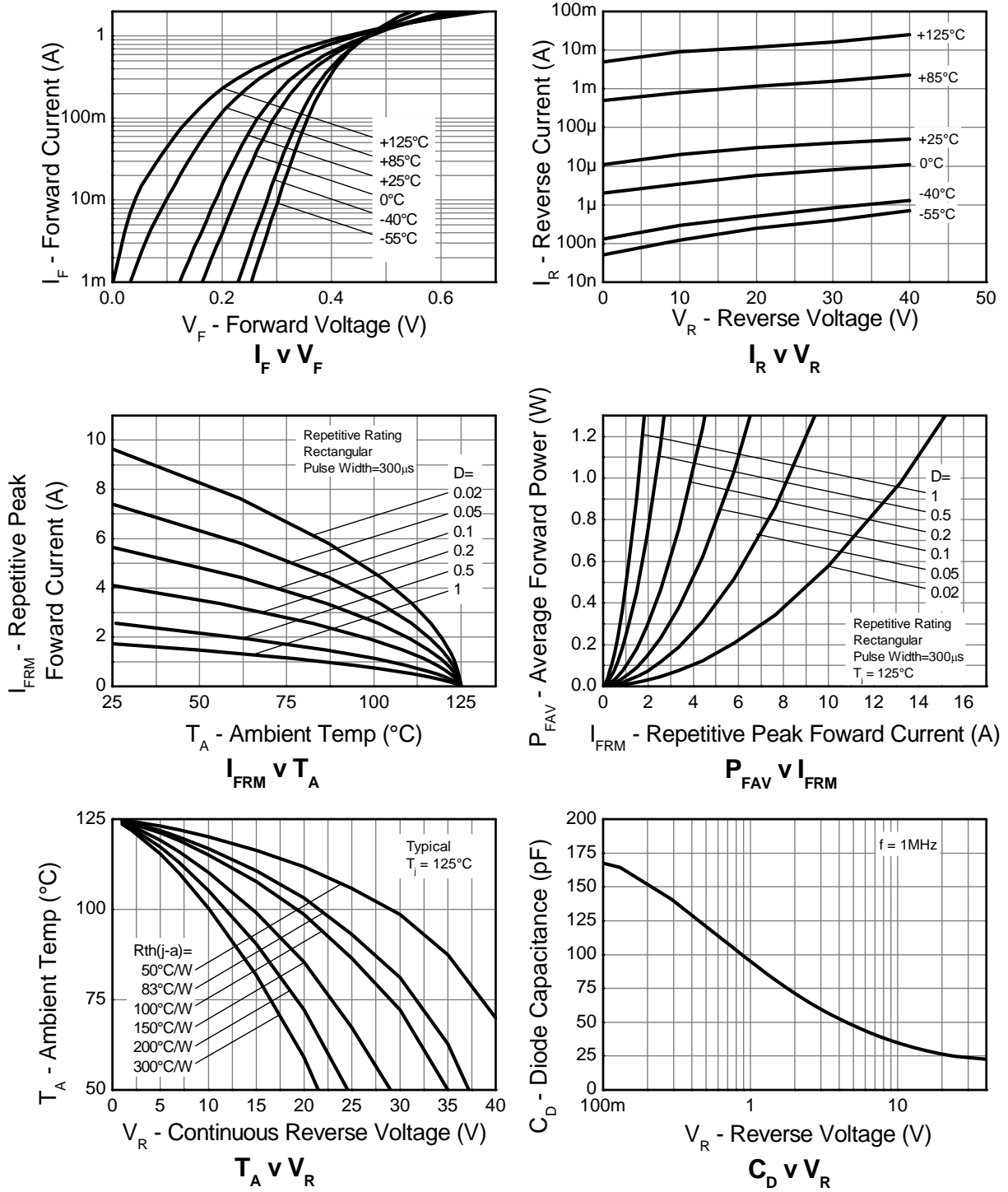



**ZXTPS718MC**

**Package Outline Dimensions**

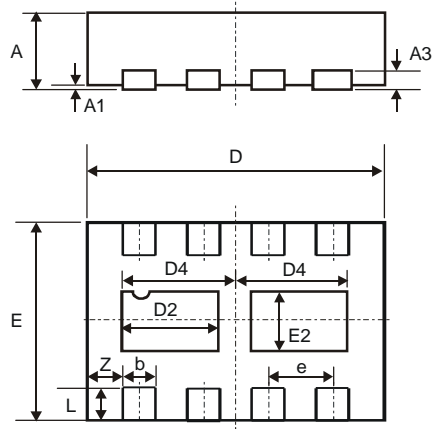

DFN3020B-8			
Dim	Min	Max	Typ
A	0.77	0.83	0.80
A1	0	0.05	0.02
A3	-	-	0.15
b	0.25	0.35	0.30
D	2.95	3.075	3.00
D2	0.82	1.02	0.92
D4	1.01	1.21	1.11
e	-	-	0.65
E	1.95	2.075	2.00
E2	0.43	0.63	0.53
L	0.25	0.35	0.30
Z	-	-	0.375
All Dimensions in mm			

**Suggested Pad Layout**

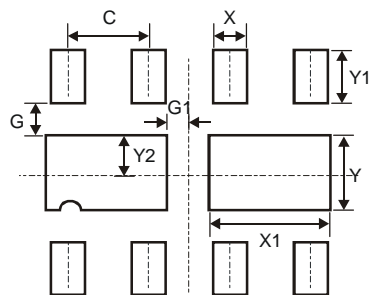

Dimensions	Value (in mm)
C	0.650
G	0.285
G1	0.090
X	0.400
X1	1.120
Y	0.730
Y1	0.500
Y2	0.365

**IMPORTANT NOTICE**

DIODES INCORPORATED MAKES NO WARRANTY OF ANY KIND, EXPRESS OR IMPLIED, WITH REGARDS TO THIS DOCUMENT, INCLUDING, BUT NOT LIMITED TO, THE IMPLIED WARRANTIES OF MERCHANTABILITY AND FITNESS FOR A PARTICULAR PURPOSE (AND THEIR EQUIVALENTS UNDER THE LAWS OF ANY JURISDICTION).

Diodes Incorporated and its subsidiaries reserve the right to make modifications, enhancements, improvements, corrections or other changes without further notice to this document and any product described herein. Diodes Incorporated does not assume any liability arising out of the application or use of this document or any product described herein; neither does Diodes Incorporated convey any license under its patent or trademark rights, nor the rights of others. Any Customer or user of this document or products described herein in such applications shall assume all risks of such use and will agree to hold Diodes Incorporated and all the companies whose products are represented on Diodes Incorporated website, harmless against all damages.

Diodes Incorporated does not warrant or accept any liability whatsoever in respect of any products purchased through unauthorized sales channel. Should Customers purchase or use Diodes Incorporated products for any unintended or unauthorized application, Customers shall indemnify and hold Diodes Incorporated and its representatives harmless against all claims, damages, expenses, and attorney fees arising out of, directly or indirectly, any claim of personal injury or death associated with such unintended or unauthorized application.

Products described herein may be covered by one or more United States, international or foreign patents pending. Product names and markings noted herein may also be covered by one or more United States, international or foreign trademarks.

**LIFE SUPPORT**

Diodes Incorporated products are specifically not authorized for use as critical components in life support devices or systems without the express written approval of the Chief Executive Officer of Diodes Incorporated. As used herein:

- C. Life support devices or systems are devices or systems which:
1. are intended to implant into the body, or
  2. support or sustain life and whose failure to perform when properly used in accordance with instructions for use provided in the labeling can be reasonably expected to result in significant injury to the user.
- D. A critical component is any component in a life support device or system whose failure to perform can be reasonably expected to cause the failure of the life support device or to affect its safety or effectiveness.

Customers represent that they have all necessary expertise in the safety and regulatory ramifications of their life support devices or systems, and acknowledge and agree that they are solely responsible for all legal, regulatory and safety-related requirements concerning their products and any use of Diodes Incorporated products in such safety-critical, life support devices or systems, notwithstanding any devices- or systems-related information or support that may be provided by Diodes Incorporated. Further, Customers must fully indemnify Diodes Incorporated and its representatives against any damages arising out of the use of Diodes Incorporated products in such safety-critical, life support devices or systems.

Copyright © 2011, Diodes Incorporated

[www.diodes.com](http://www.diodes.com)

Компания «Life Electronics» занимается поставками электронных компонентов импортного и отечественного производства от производителей и со складов крупных дистрибьюторов Европы, Америки и Азии.

С конца 2013 года компания активно расширяет линейку поставок компонентов по направлению коаксиальный кабель, кварцевые генераторы и конденсаторы (керамические, пленочные, электролитические), за счёт заключения дистрибьюторских договоров

Мы предлагаем:

- Конкурентоспособные цены и скидки постоянным клиентам.
- Специальные условия для постоянных клиентов.
- Подбор аналогов.
- Поставку компонентов в любых объемах, удовлетворяющих вашим потребностям.
- Приемлемые сроки поставки, возможна ускоренная поставка.
- Доставку товара в любую точку России и стран СНГ.
- Комплексную поставку.
- Работу по проектам и поставку образцов.
- Формирование склада под заказчика.
- Сертификаты соответствия на поставляемую продукцию (по желанию клиента).
- Тестирование поставляемой продукции.
- Поставку компонентов, требующих военную и космическую приемку.
- Входной контроль качества.
- Наличие сертификата ISO.

В составе нашей компании организован Конструкторский отдел, призванный помогать разработчикам, и инженерам.

Конструкторский отдел помогает осуществить:

- Регистрацию проекта у производителя компонентов.
- Техническую поддержку проекта.
- Защиту от снятия компонента с производства.
- Оценку стоимости проекта по компонентам.
- Изготовление тестовой платы монтаж и пусконаладочные работы.



Тел: +7 (812) 336 43 04 (многоканальный)

Email: [org@lifeelectronics.ru](mailto:org@lifeelectronics.ru)