

THIS DRAWING IS UNPUBLISHED. RELEASED FOR PUBLICATION  
 © COPYRIGHT - By - ALL RIGHTS RESERVED.

LOC	DIST	REVISIONS					
GP	00	P	LTR	DESCRIPTION	DATE	DWN	APVD
		H1		ECR-11-025464	16DEC11	RK	BVH

NOTES:

- ⚠ PITCH TOLERANCE TO BE ±.18[.007] FOR 1.27[.050] PITCH JUMPERS & ±.25[.010] FOR ALL REMAINING PITCHES. TOLERANCE TO BE NON CUMULATIVE OVER GAUGE LENGTH.
- ⚠ 11.92-152.40[.500-6.000] ARE STANDARD LENGTHS. JUMPERS ARE AVAILABLE IN INCREMENTS OF 2.50[.10] PLUS 6.35[.25] AND 19.05[.75].
- ⚠ DELETED
- ⚠ FOR CONDUCTOR PITCH 7 (2mm), ON PAGE 2 & 3, DIMENSION "B" IS 2.00[.079]
- ⚠ SPECIAL PIN LENGTHS ARE AVAILABLE FOR JUMPERS WITH A PIN CONFIGURATION OF "A" OR "B" ON LENGTHS OF UP TO 609.6[24.0] IN 2.54[.100] & 5.08[.200] PITCH VARIANTS ONLY BY ADDING THE FOLLOWING SUFFIXES:

SUFFIX	PEN LENGTH	TOLERANCE
V1	2.85 (.112)	±.305 [±.012]
V2	3.40 (.134)	
V3	4.10 (.161)	
V4	6.50 (.256)	
V5	3.10 (.122)	
V6	2.81 (.150)	
V7	4.50 (.177)	
V8	2.00 (.079)	
V9	TBD	
V10	.76 (.030)	
V11	2.41 (.095)	



6. RECOMMENDED PCB HOLE DRILLING DETAILS ARE AS FOLLOWS:-

PITCH A	ØG
1.27 (.050)	.70 (.028)
1.90 (.075)	.80 (.031)
2.54 (.100)	.95 (.037)
3.18 (.125)	.95 (.037)
3.81 (.150)	.95 (.037)
5.08 (.200)	.95 (.037)



JUMPER LENGTH	PITCH (NOMINAL)	TRANSITION MAX	MAX/MIN MARGIN	△ PIN DIAMETER	WIRE GAUGE (AWG)	MIN/MAX No OF CONDUCTORS	MAXIMUM ADHESIVE FLOW	MIN GAP BETWEEN CONDUCTORS	CONDUCTOR WIDTH	MAXIMUM INSULATION MISMATCH	MAX THICKNESS
R	A	T	C	E	-	-	V	X	Y	Z	D
11.93 (.50) TO 863.6 (30.00) IN STEPS OF 2.50 (.10) PLUS 6.35 (.25) AND 19.05 (.75)	1.00 (0.039)	4.32 [.170]	0.35 (0.014) 0.17 (.007)	0.330 (.0130) 0.317 (.0125)	28	2-70	0.38 (0.015)	0.13 (0.009)	0.76 (.030) 0.56 (.022)	.76 (.030)	.64
	1.25 (0.049)	4.32 [.170]	0.50 (0.020) 0.17 (0.007)	0.330 (0.0130) 0.317 (0.0125)	28	2-70	0.38 (0.015)	0.25 (0.010)	0.89 (.035) 0.64 (.025)	.76 (.030)	.64
	1.27 (0.050)	4.32 [.170]	0.50 (0.020) 0.17 (0.007)	0.330 (0.0130) 0.317 (0.0125)	28	2-70	0.38 (0.015)	0.25 (0.010)	0.89 (.035) 0.64 (.025)	.76 (.030)	.64
	2.00 (0.079)	5.08 [.200]	0.70 (0.028) 0.25 (0.010)	0.416 (0.0164) 0.400 (0.0157)	26	2-50	0.38 (0.015)	0.38 (0.015)	1.14 (.045) 0.89 (.035)	.76 (.030)	.84
	1.90 (0.075)	5.08 [.200]	0.70 (0.028) 0.25 (0.010)	0.416 (0.0164) 0.400 (0.0157)	26	2-50	0.38 (0.015)	0.38 (0.015)	1.14 (.045) 0.89 (.035)	.76 (.030)	.84
	2.54 (0.100)	6.35 [.250]	0.80 (0.031) 0.25 (0.010)	0.526 (0.0207) 0.505 (0.0199)	24	2-50	0.51 (0.020)	0.51 (0.020)	1.52 (.060) 1.27 (.050)	.76 (.030)	.84
	3.18 (0.125)	6.35 [.250]	1.00 (0.039) 0.25 (0.010)	0.526 (0.0207) 0.505 (0.0199)	24	2-25	0.51 (0.020)	0.51 (0.020)	1.52 (.060) 1.27 (.050)	.76 (.030)	.84
	3.81 (0.150)	6.35 [.250]	1.00 (0.039) 0.25 (0.010)	0.526 (0.0207) 0.505 (0.0199)	24	2-20	0.51 (0.020)	0.51 (0.020)	1.52 (.060) 1.27 (.050)	.76 (.030)	.84
	5.08 (0.200)	6.35 [.250]	1.00 (0.039) 0.25 (0.010)	0.526 (0.0207) 0.505 (0.0199)	24	2-15	0.51 (0.020)	0.51 (0.020)	1.52 (.060) 1.27 (.050)	.76 (.030)	.84

- ⚠ BEND RADIUS TO APPLY ONLY IN THE FLAT SECTION OF JUMPER BETWEEN THE CONDUCTOR TRANSITION AREAS.
- ⚠ PER 108-2135.
- 9. TOOL MARKS PERMISSIBLE ON BENDS. NO EXPOSED COPPER.
- ⚠ PIN DIAMETER SPECIFIED NOT APPLICABLE IN BENDING AREA OF PIN, DUE TO NORMAL DEFORMATION OF BENDING PROCESS.
- ⚠ REFER TO RELEVANT MATERIAL SPECIFICATIONS.

F - MID POINT THICKNESS BETWEEN PT 1 & PT 2	MINIMUM	MAXIMUM
	NOMEX®	.152 [.006]
POLYESTER	.152 [.006]	.305 [.012]
KAPTON®	.102 [.004]	.254 [.010]
TEFLON®	.305 [.012]	.533 [.021]

12. PRODUCT AND PROCESSING MUST MEET REQUIREMENTS OF TE CONNECTIVITY STANDARD 230-702.

Nomex®, Teflon® and Kapton® are trademarks of E. I. DuPont de Nemours.

THIS DRAWING IS A CONTROLLED DOCUMENT.

DWN J. SCHWARTZ 28FEB01  
 CHK E. FOX 28FEB01  
 APVD E. FOX 28FEB01

STE TE Connectivity

FLEXSTRIP PIN CONFIGURATIONS, GENERIC

PRODUCT SPEC  
 APPLICATION SPEC

SIZE A3 CAGE CODE 00779 DRAWING NO C-1474339 RESTRICTED TO -

SCALE N.T.S. SHEET 1 OF 4 REV H1

CUSTOMER DRAWING



**MANUFACTURING NOTE:**

**MINIMUM GAP BETWEEN STRIPS**

SK/A/Z	.75 INCH
LP	1.1 INCH

**MINIMUM CONDUCTOR COUNT PER STRIP FOR LINE JOBS**

PITCH	CONDUCTOR
1 1.27 (.050)	60
2 2.54 (.100)	60
3 3.18 (.125)	60
4 3.81 (.150)	50
5 5.08 (.200)	40
6 1.91 (.075)	60
7 2.0 (.078)	60
8 1.24 (.049)	60
9 1.0 (.039)	80



Nomex®, Teflon® and Kapton® are trademarks of E. I. DuPont de Nemours.

THIS DRAWING IS A CONTROLLED DOCUMENT.

DIMENSIONS: MM [INCHES]	TOLERANCES UNLESS OTHERWISE SPECIFIED:
0 PLC	± -
1 PLC	± -
2 PLC	± -
3 PLC	± -
4 PLC	± -
ANGLES	± 1/2°
MATERIAL	FINISH

DWN	J. SCHWARTZ	28FEB01	 TE Connectivity	
CHK	E. FOX	28FEB01		
APVD	E. FOX	28FEB01		
PRODUCT SPEC	-			
APPLICATION SPEC	-		NAME	FLEXSTRIP PIN CONFIGURATIONS, GENERIC
WEIGHT	-	-	SIZE	A3
CUSTOMER DRAWING	-		CAGE CODE	00779
-			DRAWING NO	C-1474339
-			RESTRICTED TO	-
-			SCALE	N.T.S.
-			SHEET	2 OF 4
-			REV	H1

THIS DRAWING IS UNPUBLISHED.

RELEASED FOR PUBLICATION

ALL RIGHTS RESERVED.

© COPYRIGHT - By -

LOC GP DIST 00

REVISIONS

P	LTR	DESCRIPTION	DATE	DWN	APVD
-	-	SEE SHEET 1	-	-	-

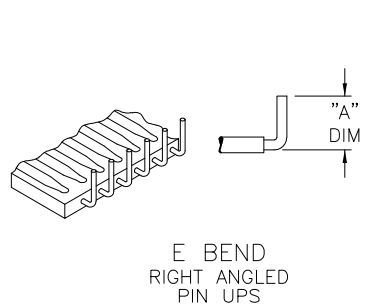

E BEND  
RIGHT ANGLED  
PIN UPS

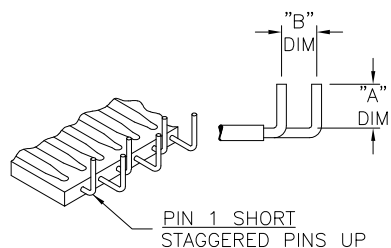

F BEND  
RIGHT ANGLED  
STAGGERED PINS UP

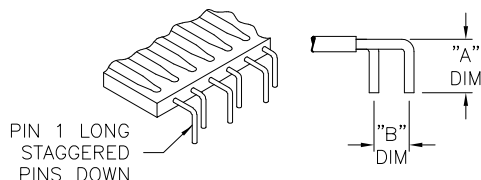

G BEND  
RIGHT ANGLED  
STAGGERED PINS DOWN

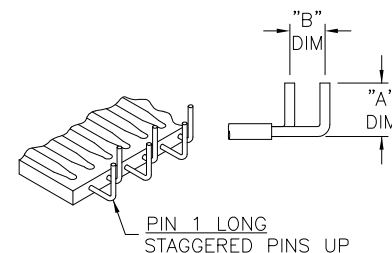

H BEND  
RIGHT ANGLED  
STAGGERED PINS UP

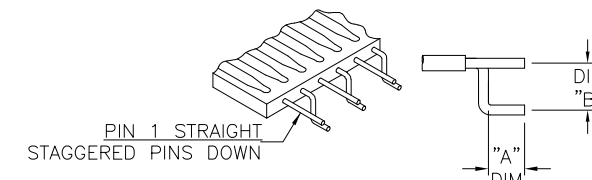

J BEND  
STRAIGHT/STAGGERED  
PINS DOWN

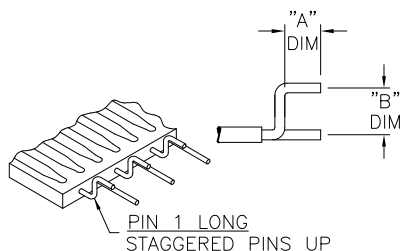

K BEND  
STRAIGHT/STAGGERED  
PINS UP

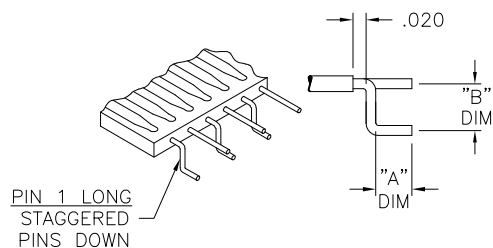

L BEND  
STRAIGHT/STAGGERED  
PINS DOWN

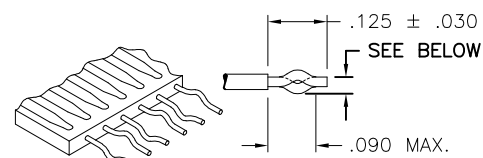

Z BEND  
DIMENSIONS  
24 AWG: .034 ±.004  
26 AWG: .028 ±.004  
28 AWG: .022 ±.004

SPECIAL JUMPERS  
SMART DESCRIPTION

FS N - 1 3.25 A G - 20 V1

( SEE NOTE 5 )

FLEXSTRIP PRODUCT CODE

INSULATION MATERIAL:  
 N - NOMEX®  
 P - POLYESTER  
 T - TEFLON®  
 K - KAPTON®

CONDUCTOR PITCH:  
 1 - 1.27(.050)  
 2 - 2.54(.100)  
 3 - 3.18(.125)  
 4 - 3.81(.150)  
 5 - 5.08(.200)  
 6 - 1.90(.075)  
 7 - 2.00(.078)  
 8 - 1.25(.049)  
 9 - 1.00(.039)

INSULATION LENGTH: (in inches)  
 .50 MIN. - 30.0 MAX.  
 IN .10 INCREMENTS PLUS .25 AND .75

SPECIAL PIN LENGTH  
 V1 - 2.84(.112)  
 V2 - 3.40(.134)  
 V3 - 4.09(.161)  
 V4 - 6.50(.256)  
 V5 - 3.01(.122)  
 V6 - 3.81(.150)  
 V7 - 4.50(.177)  
 V8 - 2.01(.079)  
 V9 - TBD  
 V10 - .76 (.030)  
 V11 - 2.41(.095)

CONDUCTOR PITCH	BENDS AVAILABLE
1 - 1.27/(.050)	E,F,G,H,J,K,L
2 - 2.54/(.100)	E,F,G,H,J,K,L
3 - 3.18/(.125)	E
4 - 3.81/(.150)	E
5 - 5.08/(.200)	E
6 - 1.91/(.075)	E,F,G,H,J,K,L
7 - 2.00/(.0787)	E,F,G,H,J,K,L
8 - 1.25/(.049)	E
9 - 1.00/(.039)	E

NUMBER OF CONDUCTORS (SEE MAX./MIN. PAGE 1)

PIN ARRANGEMENT (RIGHT)

PIN ARRANGEMENT (LEFT)

E THRU L BEND
"A" DIM
3.18±0.76/(.125±.030)
"B" DIM
2.54±0.25/(.100±.010)

SPECIAL FLEXSTRIP BENDS

SPECIAL FLEXSTRIP BENDS  
E THRU R, AND Z MAY APPLY TO EITHER  
LEFT OF RIGHT SIDE

Nomex®, Teflon® and Kapton® are trademarks of E. I. DuPont de Nemours.

THIS DRAWING IS A CONTROLLED DOCUMENT.

DIMENSIONS: MM [INCHES]	TOLERANCES UNLESS OTHERWISE SPECIFIED:
	0 PLC ± -
	1 PLC ± -
	2 PLC ± -
	3 PLC ± -
	4 PLC ± -
	ANGLES ± 1/2°
MATERIAL	FINISH
-	-

DWN J. SCHWARTZ 28FEB01

CHK E. FOX 28FEB01

APVD E. FOX 28FEB01

PRODUCT SPEC

APPLICATION SPEC

WEIGHT -

CUSTOMER DRAWING

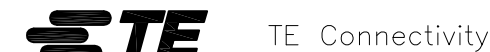

NAME FLEXSTRIP PIN CONFIGURATIONS, GENERIC

SIZE A3 CAGE CODE 00779 DRAWING NO C-1474339 RESTRICTED TO -

SCALE N.T.S. SHEET 3 OF 4 REV H1

THIS DRAWING IS UNPUBLISHED. RELEASED FOR PUBLICATION  
 © COPYRIGHT - By - ALL RIGHTS RESERVED.

LOC GP	DIST 00	REVISIONS		
P	LTR	DESCRIPTION	DATE	DWN
		SEE SHEET 1	-	-

NORMAL CONDUCTOR PITCH		1.00 (.039)	1.25 (.049)	1.27 (.050)	1.90 (.075)	2.00 (.078)	2.54 (.100)	3.18 (.125)	3.81 (.150)	5.08 (.200)
WIRE GAUGE		AWG 28	AWG 28	AWG 28	AWG 26	AWG 26	AWG 24	AWG 24	AWG 24	AWG 24
NOMINAL WIRE DIAMETER		.32(.0126)	.32(.0126)	.32(.0126)	.40(.0159)	.40(.0159)	.51(.0201)	.51(.0201)	.51(.0201)	.51(.0201)
CURRENT RATING		8	8	8	8	8	8	8	8	8
VOLTAGE RATING		8	8	8	8	8	8	8	8	8
MAX NUMBER OF CONDUCTORS PER JUMPER		8	8	8	8	8	8	8	8	8
MIN BREAKDOWN VOLTAGE @ 1 MIN		8	8	8	8	8	8	8	8	8
INSULATION RESISTANCE (GND. SIG. GND) 305 (12") SAMPLE @ 500VDC	P N T K	8	8	8	8	8	8	8	8	8
CAPACITANCE (pf / 50.8 (12") LENGTH) (GND, SIG, GND) (AVERAGE)	P N T K	8	8	8	8	8	8	8	8	8
CHARACTERISTIC IMPEDANCE (GND. SIG. GND) (AVERAGE)	P N T K	8	8	8	8	8	8	8	8	8
APPLICATION TEMP RANGE (C°) (FOR SOLDERING)	P N T K	200 / 4 sec 200 / 4 sec 240 / 4 sec 240 / 4 sec	200 / 4 sec 200 / 4 sec 240 / 4 sec 240 / 4 sec	200 / 4 sec 200 / 4 sec 240 / 4 sec 240 / 4 sec	200 / 4 sec 200 / 4 sec 240 / 4 sec 240 / 4 sec	200 / 4 sec 200 / 4 sec 240 / 4 sec 240 / 4 sec	250 / 4 sec 250 / 4 sec 260 / 5 sec 260 / 5 sec	250 / 4 sec 250 / 4 sec 260 / 5 sec 260 / 5 sec	250 / 4 sec 250 / 4 sec 260 / 5 sec 260 / 5 sec	250 / 4 sec 250 / 4 sec 260 / 5 sec 260 / 5 sec
OPERATING TEMPERATURE (C°)	P N T K	-40 to 105 (For all Conductor Pitches) -40 to 125 (For all Conductor Pitches) -40 to 150 (For all Conductor Pitches) -40 to 150 (For all Conductor Pitches)								
MINIMUM BEND RADIUS	P N T K	3.18mm (For all Conductor Pitches) 3.18mm (For all Conductor Pitches) 3.18mm (For all Conductor Pitches) 3.18mm (For all Conductor Pitches)								
UL STYLE NUMBER	P N T K	2639 (For all Conductor Pitches .100 and above) 5456 (For all Conductor Pitches .100 and above) 2928 (For all Conductor Pitches .100 and above) 2927 (For all Conductor Pitches .100 and above)								

ABR.	MATERIAL	SPECIFICATION
	COPPER WIRE	100-1577
P	POLYESTER	100-1575
N	NOMEX®	100-1758
T	TEFLON®	100-1574
K	KAPTON®	100-1576

Nomex®, Teflon® and Kapton® are trademarks of E. I. DuPont de Nemours.

THIS DRAWING IS A CONTROLLED DOCUMENT.		DWN J. SCHWARTZ 28FEB01	 TE Connectivity	
DIMENSIONS: MM [INCHES]		CHK E. FOX 28FEB01		
TOLERANCES UNLESS OTHERWISE SPECIFIED:		APVD E. FOX 28FEB01	NAME FLEXSTRIP PIN CONFIGURATIONS, GENERIC	
		PRODUCT SPEC	-	
0 PLC ± - 1 PLC ± - 2 PLC ± - 3 PLC ± - 4 PLC ± - ANGLES ± 1/2°		APPLICATION SPEC	-	
MATERIAL		WEIGHT	SIZE A3	CAGE CODE 00779
			DRAWING NO C-1474339	RESTRICTED TO
CUSTOMER DRAWING			SCALE N.T.S.	SHEET 4 OF 4
			REV H1	

Компания «Life Electronics» занимается поставками электронных компонентов импортного и отечественного производства от производителей и со складов крупных дистрибьюторов Европы, Америки и Азии.

С конца 2013 года компания активно расширяет линейку поставок компонентов по направлению коаксиальный кабель, кварцевые генераторы и конденсаторы (керамические, пленочные, электролитические), за счёт заключения дистрибьюторских договоров

Мы предлагаем:

- Конкурентоспособные цены и скидки постоянным клиентам.
- Специальные условия для постоянных клиентов.
- Подбор аналогов.
- Поставку компонентов в любых объемах, удовлетворяющих вашим потребностям.
- Приемлемые сроки поставки, возможна ускоренная поставка.
- Доставку товара в любую точку России и стран СНГ.
- Комплексную поставку.
- Работу по проектам и поставку образцов.
- Формирование склада под заказчика.
- Сертификаты соответствия на поставляемую продукцию (по желанию клиента).
- Тестирование поставляемой продукции.
- Поставку компонентов, требующих военную и космическую приемку.
- Входной контроль качества.
- Наличие сертификата ISO.

В составе нашей компании организован Конструкторский отдел, призванный помогать разработчикам, и инженерам.

Конструкторский отдел помогает осуществить:

- Регистрацию проекта у производителя компонентов.
- Техническую поддержку проекта.
- Защиту от снятия компонента с производства.
- Оценку стоимости проекта по компонентам.
- Изготовление тестовой платы монтаж и пусконаладочные работы.



Тел: +7 (812) 336 43 04 (многоканальный)

Email: [org@lifeelectronics.ru](mailto:org@lifeelectronics.ru)