

AG606

Push-Pull CATV Amplifier



Product Features

- 50 – 1000 MHz
- ± 0.7 dB Gain Flatness
- +20 dBm P1dB
- +37 dBm Output IP3
- +73 dBm Output IP2
- -68 dBc CTB
+34 dBmV/channel, 79 channels
- -80 dBc CSO
+34 dBmV/channel, 79 channels
- Matched amplifiers for a push-pull configuration
- +7V Single Positive Supply
- MTTF > 1000 Years

Product Description

The AG606 is a dual amplifier containing two internal matched amplifiers optimal for a push-pull configuration. The internal amplifiers employ InGaP HBT technology for a cost-effective low-distortion solution.

The AG606 is ideal for drop amplifiers, splitters, and other low to moderate power outside plant CATV applications. The amplifier can also be useful in low power headend applications such as linear laser drivers.

The AG606 has excellent VSWR when used in a 75 Ω push-pull configuration. It is provided in a low-cost environmentally-friendly lead-free/green/ RoHS-compliant SOIC-8 package.

Functional Diagram

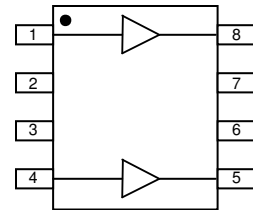

Function	Pin No.
Amp 1 Input	1
Amp 2 Input	4
Amp 2 Output	5
Amp 1 Output	8
Ground	2, 3, 6, 7, Backside paddle

Applications

- CATV Head End Equipment
- CATV Line Amplifiers
- FTTH Repeaters

Single-ended Device Specifications ⁽¹⁾

Parameter	Units	Min	Typ	Max
Test Frequency	MHz		800	
Gain	dB	13.2	14.3	15.5
Output IP3 ⁽²⁾	dBm	+33.5	+36	
Device Current	mA	76	82.5	90
Device Voltage	V		5.25	

1. Test conditions unless otherwise noted: T = 25 °C, 800 MHz on each individual single-branch amplifier in a 50 Ω test fixture using a +7V supply and a 20.5 Ω dropping resistor.
2. 3OIP measured with two tones at an output power of +5 dBm/ tone separated by 1 MHz. The suppression on the largest IM3 product is used to calculate the 3OIP using a 2:1 rule.
3. Typical parameters reflect performance in a push-pull application circuit.
4. Balun, board, and connector losses have not been extracted, but typically account of 0.4 dB loss midband and 1.1 dB loss at 860 MHz.
5. Measured at +34 dBmV/channel, 79 channels Flat Loading.
6. OIP2 is measured at f1 + f2 at +5 dBm / tone.

Typical Performance ⁽³⁾

Parameter	Units	Typical			
Frequency	MHz	50	250	450	860
Gain ⁽⁴⁾	dB	14.3	14.2	13.9	12.9
Input R. L.	dB	21	28	18	11
Output R. L.	dB	17	18	16	18
CTB ⁽⁵⁾	dBc	-69	-67	-67	
CSO ⁽⁵⁾	dBc	-81	-87	-80	
XMOD ⁽⁵⁾	dBc	-60	-61	-60	
Output P1dB	dBm	+20.7	+20.5	+20.3	+22
Output IP2 ⁽⁶⁾	dBm	+73.6	+76.1	+76.4	+76.6
Output IP3 ⁽²⁾	dBm	+37.5	+37.5	+37.3	+39.2
Noise Figure ⁽⁴⁾	dB	5	5	5.3	5.9
Device Bias	V	+5.25 V @ 165 mA			

Absolute Maximum Rating

Parameter	Rating
Storage Temperature	-55 to +125 °C
Supply Voltage	+7 V
RF Input Power (continuous)	+13dBm
Thermal Resistance, Rth	63 °C/W
Max Junction Temperature, Tj For 10 ⁶ hours MTTF	177 °C

Operation of this device above any of these parameters may cause permanent damage.

Ordering Information

Part No.	Description
AG606-G	Push-pull CATV Amplifier (lead-free /Green/ RoHS-compliant SOIC8 Pkg)
AG606-PCB	Fully Assembled CATV Evaluation Board

Standard T/R size = 500 pieces on a 7" reel.

Typical Device Data – 50Ω Z₀

S-Parameters (V_{dev} = +5.25 V, I_{cc} = 82.5 mA, T = 25 °C, unmatched 50 ohm system, calibrated to device leads)
 These represent a single-ended amplifier in the AG606, with there being two matched amplifiers inside the package.

Freq (MHz)	S11 (dB)	S11 (ang)	S21 (dB)	S21 (ang)	S12 (dB)	S12 (ang)	S22 (dB)	S22 (ang)
50	-12.03	178.56	14.61	177.32	-18.85	-0.01	-17.45	178.57
100	-12.09	174.32	14.61	175.28	-18.74	-1.56	-17.08	178.23
150	-11.81	172.20	14.62	173.13	-18.76	-2.21	-17.28	176.63
200	-11.81	169.91	14.59	170.74	-18.81	-3.25	-16.86	176.45
250	-11.64	168.30	14.62	168.67	-18.77	-3.74	-17.24	173.88
300	-11.79	166.47	14.63	165.71	-18.81	-4.12	-17.00	174.14
350	-11.76	164.70	14.68	163.24	-18.79	-4.96	-17.20	172.40
400	-12.02	162.35	14.59	161.23	-18.84	-5.99	-16.85	173.24
450	-11.92	159.27	14.48	158.25	-18.82	-5.99	-17.02	170.87
500	-11.92	156.13	14.53	156.14	-18.80	-6.63	-16.70	169.98
550	-11.77	154.71	14.48	154.05	-18.86	-7.58	-16.78	167.35
600	-11.75	151.64	14.52	151.45	-18.79	-8.02	-16.47	167.79
650	-11.67	150.04	14.45	148.59	-18.74	-9.17	-16.49	164.94
700	-11.89	147.47	14.41	146.59	-18.83	-9.41	-16.48	164.76
750	-11.72	145.07	14.43	144.30	-18.89	-10.48	-16.43	161.86
800	-11.76	143.08	14.33	141.92	-18.87	-11.22	-16.23	161.91
850	-11.56	141.20	14.36	139.40	-18.87	-11.88	-15.86	158.92
900	-11.65	138.97	14.26	137.14	-18.80	-12.23	-15.78	159.88
950	-11.57	137.28	14.28	134.86	-18.79	-13.52	-15.51	156.89
1000	-11.56	135.12	14.19	132.17	-18.86	-13.15	-15.34	156.79

Typical Device Data – 50Ω Z₀

S-Parameters (V_{dev} = +5.25 V, I_{cc} = 82.5 mA, T = 25 °C, unmatched 37.5 ohm system, calibrated to device leads)
 These represent a single-ended amplifier in the AG606, with there being two matched amplifiers inside the package.

Freq (MHz)	S11 (dB)	S11 (ang)	S21 (dB)	S21 (ang)	S12 (dB)	S12 (ang)	S22 (dB)	S22 (ang)
50	-34.66	173.49	14.79	177.27	-18.66	-0.06	-19.98	-0.57
100	-33.64	133.95	14.81	175.12	-18.54	-1.71	-20.40	-3.63
150	-30.17	137.29	14.82	172.89	-18.56	-2.45	-20.15	-4.04
200	-29.21	131.02	14.80	170.45	-18.60	-3.54	-20.91	-7.28
250	-27.90	131.37	14.83	168.30	-18.57	-4.11	-20.34	-5.91
300	-28.12	124.34	14.84	165.33	-18.61	-4.51	-20.82	-9.61
350	-27.59	122.31	14.88	162.80	-18.59	-5.40	-20.57	-10.25
400	-27.52	110.86	14.79	160.77	-18.65	-6.45	-21.33	-14.80
450	-25.69	107.75	14.68	157.66	-18.62	-6.58	-21.31	-13.74
500	-24.49	101.63	14.73	155.45	-18.61	-7.32	-21.94	-15.66
550	-23.76	104.95	14.68	153.27	-18.66	-8.35	-22.13	-13.89
600	-22.84	100.16	14.72	150.61	-18.59	-8.86	-22.79	-18.83
650	-22.46	101.72	14.65	147.66	-18.53	-10.10	-23.13	-17.61
700	-22.06	95.00	14.60	145.62	-18.64	-10.38	-23.54	-19.44
750	-21.15	95.84	14.62	143.20	-18.70	-11.58	-24.06	-16.74
800	-20.79	94.07	14.53	140.77	-18.68	-12.37	-25.05	-20.60
850	-20.09	95.55	14.56	138.11	-18.67	-13.17	-26.61	-16.06
900	-19.78	92.24	14.45	135.83	-18.60	-13.53	-27.43	-23.50
950	-19.42	92.70	14.48	133.44	-18.59	-14.94	-29.28	-17.34
1000	-18.88	90.91	14.39	130.68	-18.66	-14.64	-31.32	-18.82

Application Circuit PC Board Layout

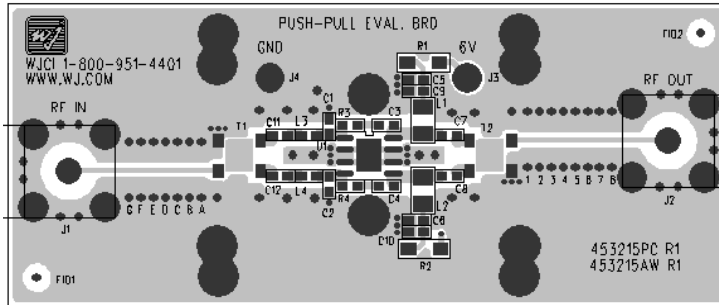

Circuit Board Material: .028" FR4, 4 - layer, 1 oz copper, Microstrip line details: width = .021", spacing = .021". C1, C2, R3, C3, R4 and C4 are shown in the silkscreen but are not required in the schematic.

Typical RF Performance at 25 °C

Frequency	MHz	50	250	450	860
Gain ⁽¹⁾	dB	14.3	14.2	13.9	12.9
Input R.L.	dB	21	28	18	11
Output R.L.	dB	17	18	16	18
CTB ⁽²⁾	dBc	-69	-67	-67	
CSO ⁽²⁾	dBc	-81	-87	-80	
XMOD ⁽²⁾	dBc	-60	-61	-60	
Output P1dB	dBm	+20.7	+20.5	+20.3	+22
Output IP2 ⁽³⁾	dBm	+73.6	+76.1	+76.4	+76.6
Output IP3 ⁽⁴⁾	dBm	+37.5	+37.5	+37.3	+39.2
Noise Figure ⁽¹⁾	dB	5	5	5.3	5.9
Device Current	mA	165			
Device Voltage	V	+5.25			

- Balun, board, and connector losses have not been extracted, but typically account for 0.4 dB loss midband and 1.1 dB loss at 860 MHz.
- CSO, CTB, & XMOD are measured at +34 dBmV/channel, 79 channels Flat Loading.
- OIP2 is measured at f1 + f2 at 5 dBm / tone.
- OIP3 is measured at +5 dBm / tone with 1 MHz spacing.

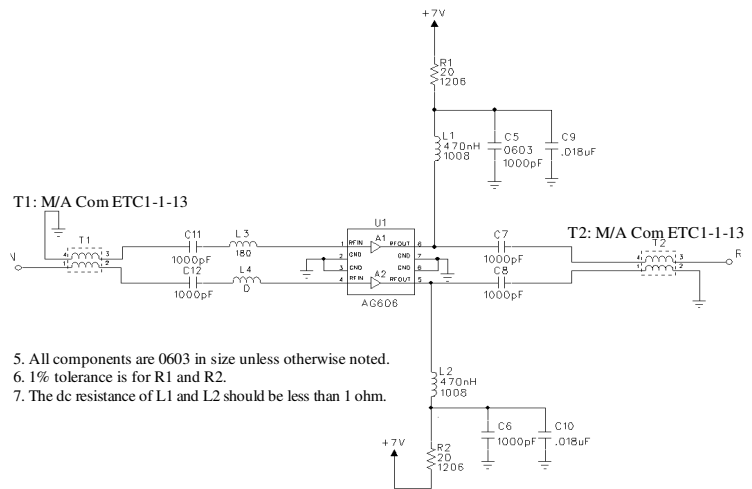

- All components are 0603 in size unless otherwise noted.
- 1% tolerance is for R1 and R2.
- The dc resistance of L1 and L2 should be less than 1 ohm.

Recommended Bias Resistor Values

Supply Voltage	R1/R2 Value	Size
7 V	20.5 ohms	1206
8 V	32.5 ohms	1210
9 V	44.5 ohms	2010
10 V	56.5 ohms	2010
12 V	81 ohms	2010
24 V	227 ohms	2 Watts

75 Ω Push-Pull Application Circuit Performance (Vsupply = +7 V, Rbias = 20.5 Ω, 25 °C)

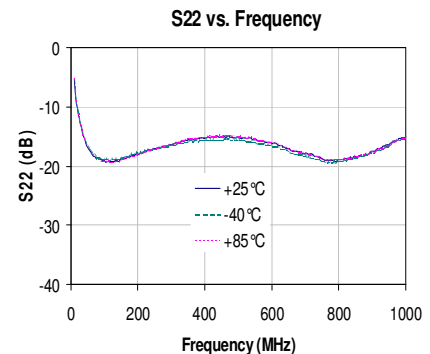
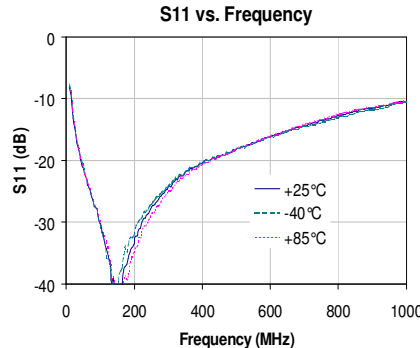
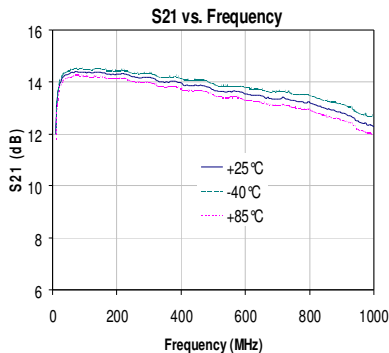

75 Ω Push-Pull Application Circuit Performance (Cont'd)

(Vsupply=7V, Rbias= 20.5 Ω , 25 $^{\circ}$ C)

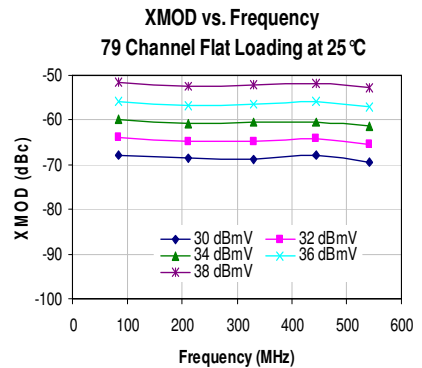
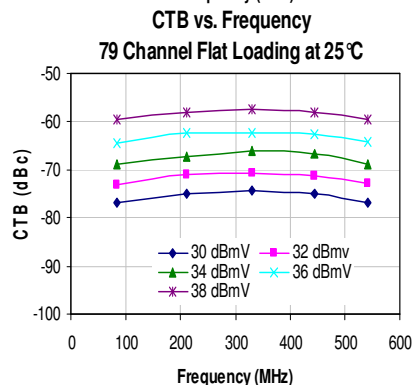
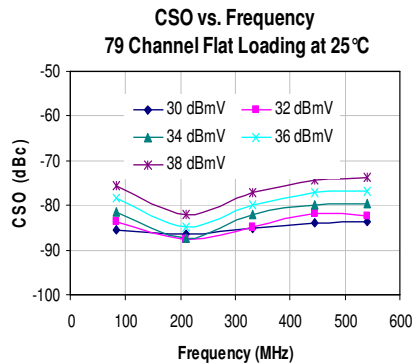
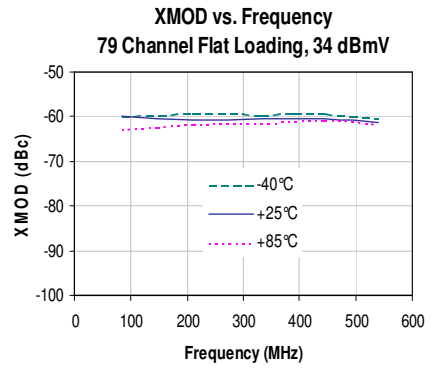
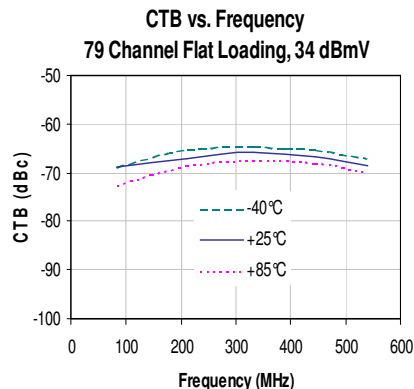
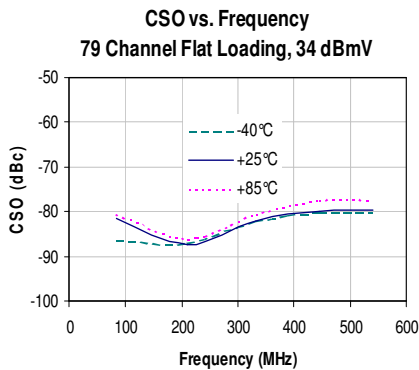
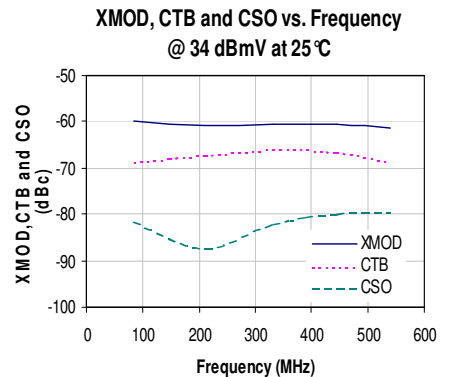
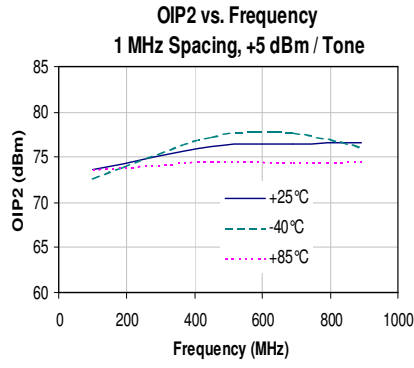
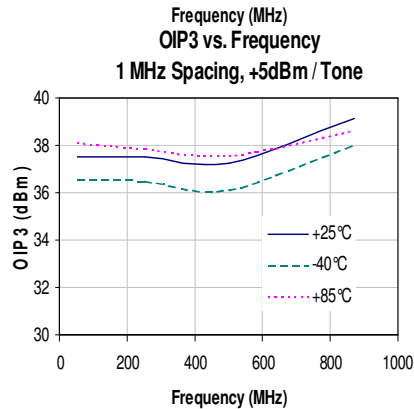
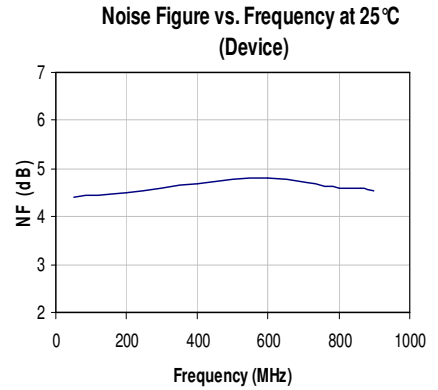
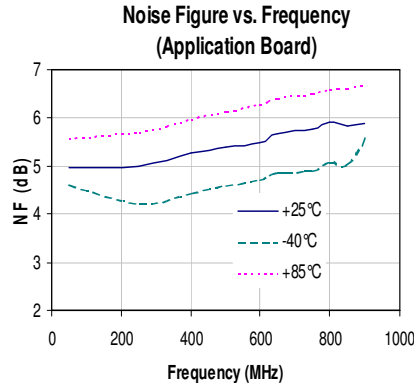
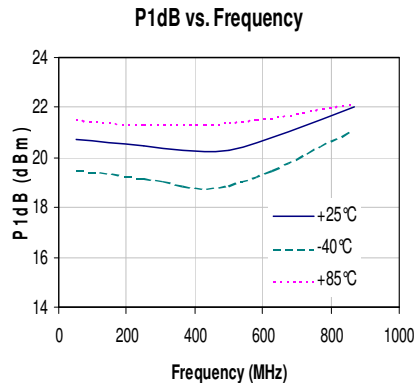

Компания «Life Electronics» занимается поставками электронных компонентов импортного и отечественного производства от производителей и со складов крупных дистрибьюторов Европы, Америки и Азии.

С конца 2013 года компания активно расширяет линейку поставок компонентов по направлению коаксиальный кабель, кварцевые генераторы и конденсаторы (керамические, пленочные, электролитические), за счёт заключения дистрибьюторских договоров

Мы предлагаем:

- Конкурентоспособные цены и скидки постоянным клиентам.
- Специальные условия для постоянных клиентов.
- Подбор аналогов.
- Поставку компонентов в любых объемах, удовлетворяющих вашим потребностям.
- Приемлемые сроки поставки, возможна ускоренная поставка.
- Доставку товара в любую точку России и стран СНГ.
- Комплексную поставку.
- Работу по проектам и поставку образцов.
- Формирование склада под заказчика.
- Сертификаты соответствия на поставляемую продукцию (по желанию клиента).
- Тестирование поставляемой продукции.
- Поставку компонентов, требующих военную и космическую приемку.
- Входной контроль качества.
- Наличие сертификата ISO.

В составе нашей компании организован Конструкторский отдел, призванный помогать разработчикам, и инженерам.

Конструкторский отдел помогает осуществить:

- Регистрацию проекта у производителя компонентов.
- Техническую поддержку проекта.
- Защиту от снятия компонента с производства.
- Оценку стоимости проекта по компонентам.
- Изготовление тестовой платы монтаж и пусконаладочные работы.



Тел: +7 (812) 336 43 04 (многоканальный)

Email: org@lifeelectronics.ru