



# Multi-Channel Low-Voltage Remote Diode Sensor Family

---

## EMC1812/13/14/15/33 Data Sheet

---

### Features

---

- Measures Temperature Rate of Change Calculation with Preemptive Alert(s) Limits
- Up to Four External Temperature Monitors:
  - **8 Lead Devices:**  $\pm 1^{\circ}\text{C}$  maximum accuracy ( $-20^{\circ}\text{C}$  to  $+105^{\circ}\text{C}$   $T_A$ ,  $-40^{\circ}\text{C}$  to  $+125^{\circ}\text{C}$   $T_D$ )
  - $\pm 1.5^{\circ}\text{C}$  maximum accuracy ( $-40^{\circ}\text{C}$  to  $+125^{\circ}\text{C}$   $T_A$ ,  $-40^{\circ}\text{C}$  to  $+125^{\circ}\text{C}$   $T_D$ )
  - **10 Lead Devices:**  $\pm 1^{\circ}\text{C}$  maximum accuracy ( $-20^{\circ}\text{C}$  to  $+125^{\circ}\text{C}$   $T_A$ ,  $-40^{\circ}\text{C}$  to  $+125^{\circ}\text{C}$   $T_D$ )
  - $\pm 1.5^{\circ}\text{C}$  maximum accuracy ( $-40^{\circ}\text{C}$  to  $+125^{\circ}\text{C}$   $T_A$ ,  $-40^{\circ}\text{C}$  to  $+125^{\circ}\text{C}$   $T_D$ )
- Internal Temperature Sensor:
  - $\pm 1^{\circ}\text{C}$  maximum accuracy,  $-40^{\circ}\text{C}$  to  $+125^{\circ}\text{C}$
- Temperature Sensor Resolution (Internal/External):  $0.125^{\circ}\text{C}$
- SMBus/I<sup>2</sup>C-Compatible Interface (up to 400 kHz)
  - Programmable or fixed address options
- Configurable Alert Pins
- Operating Voltage: 1.62V to 3.6V
- Temperature Range:  $-40^{\circ}\text{C}$  to  $+125^{\circ}\text{C}$
- Other Features: Auto-Beta Compensation, Configurable Ideality Factor, Hottest Diode Compare, Resistance Error Correction
- Available in 8-Lead 2x2 mm WDFN and 10-Lead 2.5x2.0 mm VDFN Packages

### Typical Applications

---

- Temperature Sensitive Storage
- Industrial
- IoT for Low-System Voltage
- Portable Electronics
- Handheld Gaming
- Computing
- Food Storage

### Description

---

The EMC1812/13/14/15/33 devices are high-accuracy, 2-wire (I<sup>2</sup>C) temperature sensors. The devices monitor up to five temperature channels. Advanced features, such as Resistance Error Correction (REC), Beta Compensation (to support CPU diodes requiring the BJT/Transistor model), and rate of temperature change measurement combine to provide a robust solution for complex environmental monitoring applications.

# Multi-Channel Low-Voltage Remote Diode Sensor Family

This device family introduces rate of change temperature measurement with associated alerts. This provides a preemptive system alert and another protective measurement layer to catch and manage variable system temperatures.

The Resistance Error Correction feature automatically eliminates the temperature error caused by series resistance, allowing for greater flexibility in routing thermal diodes. Beta compensation eliminates temperature errors caused by low, variable beta transistors common in current fine geometry processors. The automatic beta detection feature determines the optimal sensor external diode/transistor settings. This frees up the user from providing unique sensor configurations for each temperature monitoring application. These advanced features plus  $\pm 1^{\circ}\text{C}$  measurement accuracy for both external and internal diode temperatures provide a low-cost, highly flexible and accurate solution for critical temperature monitoring applications.

## Package Type



**Note:** \* Includes Exposed Thermal Pad (EP); see 3. [Pin Descriptions](#)

# Multi-Channel Low-Voltage Remote Diode Sensor Family

## Functional Block Diagram



# Multi-Channel Low-Voltage Remote Diode Sensor Family

## Table of Contents

Features.....	1
Typical Applications.....	1
Description.....	1
Package Type.....	2
Functional Block Diagram.....	3
1. Electrical Characteristics.....	6
1.1. Absolute Maximum Ratings.....	6
2. Typical Operating Curves.....	10
3. Pin Descriptions.....	11
3.1. Power Supply ( $V_{DD}$ ).....	12
3.2. Diode 1 Pair (DN1/DP1).....	12
3.3. THERM LIMIT ALERT ( $\overline{THERM}/ADDR$ ).....	12
3.4. Ground (GND).....	12
3.5. Maskable ALERT ( $\overline{ALERT}/THERM2$ ).....	12
3.6. SMBus/I <sup>2</sup> C Data (SDA).....	12
3.7. DP/DP1.....	12
3.8. DN/DN1.....	12
3.9. DP2.....	12
3.10. DN2.....	12
3.11. Anti-Parallel Diode Pair (DP2/DN3 and DN2/DP3).....	12
3.12. Anti-Parallel Diode Pair (DP1/DN2 and DN1/DP2).....	13
3.13. Anti-Parallel Diode Pair (DP3/DN4 and DN3/DP4).....	13
3.14. SMBus Clock (SCL).....	13
3.15. Exposed Thermal Pad (EP).....	13
4. Detailed Description.....	14
5. System Block Diagram.....	15
5.1. Temperature Measurement.....	15
5.2. Temperature Measurement Results and Data.....	15
5.3. Limit Registers.....	16
5.4. Limit Register Interaction.....	17
5.5. $\overline{ALERT}/THERM2$ Output.....	17
5.6. $\overline{THERM}$ Output.....	18
5.7. $\overline{THERM}$ Pin Address Decoding.....	18
5.8. External Diode Connections.....	19
5.9. Power States.....	19
5.10. Conversion Rates.....	19

# Multi-Channel Low-Voltage Remote Diode Sensor Family

---

---

5.11. Dynamic Averaging.....	20
5.12. Digital Filter.....	21
5.13. Beta Compensation.....	22
5.14. Resistance Error Correction (REC).....	23
5.15. Programmable External Diode Ideality Factor.....	24
5.16. Diode Faults.....	25
5.17. Consecutive Alerts.....	26
5.18. "Hottest Of" Comparison.....	27
5.19. Rate of Change.....	27
<b>6. System Management Bus Protocol.....</b>	<b>31</b>
6.1. SMBus Start Bit.....	31
6.2. SMBus Address and RD/WR Bit.....	31
6.3. SMBus ACK and NACK Bits.....	31
6.4. SMBus Stop Bit.....	31
6.5. SMBus Time-Out.....	31
6.6. SMBus and I <sup>2</sup> C Compliance.....	32
6.7. SMBus Protocols.....	32
6.8. THERM Pin Considerations.....	34
6.9. Register Summary.....	35
6.10. Data Read Interlock.....	38
<b>7. Packaging Information.....</b>	<b>90</b>
7.1. Package Marking Information.....	90
<b>8. Revision History.....</b>	<b>97</b>
The Microchip Web Site.....	98
Customer Change Notification Service.....	98
Customer Support.....	98
Product Identification System.....	99
Microchip Devices Code Protection Feature.....	100
Legal Notice.....	100
Trademarks.....	100
Quality Management System Certified by DNV.....	101
Worldwide Sales and Service.....	102

## 1. Electrical Characteristics

### 1.1 Absolute Maximum Ratings

<b>V<sub>DD</sub></b>	4.0V
<b>Voltage at all Input/Output Pins</b>	GND – 0.3V to 4.0V
<b>Storage Temperature</b>	–65°C to +150°C
<b>Ambient Temperature with Power Applied</b>	–40°C to +125°C
<b>Junction Temperature (T<sub>J</sub>)</b>	+150°C
<b>ESD Protection on All Pins (HBM:MM)</b>	(8 kV:400V)
<b>Latch-Up Current at Each Pin (+25°C)</b>	±200 mA

**Note:** Stresses above those listed under “Absolute Maximum Ratings” may cause permanent damage to the device. This is a stress rating only and functional operation of the device at those or any other conditions above those indicated in the operation listings of this specification is not implied. Exposure above maximum rating conditions for extended periods may affect device reliability.

**Table 1-1. DC Characteristics**

Electrical Specifications: Unless otherwise specified, all limits apply for typical values at ambient temperature

1.62V ≤ V<sub>DD</sub> ≤ +3.6V at –40°C ≤ T<sub>A</sub> ≤ +125°C

Parameters	Sym.	Min.	Typ.	Max.	Units	Conditions
Supply Voltage	V <sub>DD</sub>	1.62	—	3.6	V	
Supply Current	I <sub>DD</sub>	—	20	80	μA	0.03125 conversion/second, dynamic averaging disabled
		—	25	164	μA	1 conversion/second, dynamic averaging disabled
		—	205	432	μA	4 conversions/second, dynamic averaging disabled
		—	800	—	μA	> 16 conversions/second, dynamic averaging enabled
Standby Supply Current	I <sub>DD_OS</sub>	—	15	75	μA	Device in One-Shot state, no active I <sup>2</sup> C communications, $\overline{\text{ALERT}}$ and $\overline{\text{THERM}}$ pins not asserted
Power-on Reset Release Voltage	PORR	—	1.45	—	V	Rising V <sub>DD</sub>
Power-Up Timer	tPWRT	—	15	—	ms	
V <sub>DD</sub> Rise Rate	VDD_RISE	0.05	—	—	V/ms	0 to 2.75V in ~ 60 ms

# Multi-Channel Low-Voltage Remote Di...

## Electrical Characteristics

.....continued						
Parameters	Sym.	Min.	Typ.	Max.	Units	Conditions
<b>Internal Temperature Monitor</b>						
Temperature Accuracy	—	—	±0.25	±1	°C	
<b>External Temperature Monitor</b>						
Temperature Accuracy - 8 Lead	—	—	±0.25	±1	°C	-20°C < T <sub>A</sub> < 105°C, -40°C < T <sub>D</sub> < +125°C, 2N3904
		—	±0.25	±1.5	°C	-40°C < T <sub>A</sub> < +125°C, -40°C < T <sub>D</sub> < +125°C, 2N3904
Temperature Accuracy - 10 Lead	—	—	±0.25	±1	°C	-20°C < T <sub>A</sub> < 125°C, -40°C < T <sub>D</sub> < +125°C, 2N3904
		—	±0.25	±1.5	°C	-40°C < T <sub>A</sub> < +125°C, -40°C < T <sub>D</sub> < +125°C, 2N3904
Temperature Resolution	—	—	0.125		°C	
<b>Timing and Capacitive Filter</b>						
Time to First Communications	t <sub>INT_T</sub>	—	15	20	ms	Time after power-up before ready to begin communications and measurement
Conversion Time per Channel	t <sub>CONV</sub>	—	25	—	ms	Default settings
Time to First Conversion from One-shot		—	5	—	ms	
Time to First Conversion from Standby	t <sub>CONV1</sub>	—	220	—	ms	Default settings
Capacitive Filter	C <sub>FILTER</sub>	—	2.2	2.7	nF	Connected across external diode
<b>ALERT and THERM Pins</b>						
Output Low Voltage	V <sub>OL</sub>	0.4	—	—	V	I <sub>SINK</sub> = 8 mA
Leakage Current	I <sub>LEAK</sub>	—	—	±5	µA	ALERT and THERM pins Device powered pull-up voltage < 3.6V
<b>SCL and SDA</b>						
<b>Input</b>						
High-Level Voltage	V <sub>IH</sub>	0.7V <sub>DD</sub>	—	—	V	
Low-Level Voltage	V <sub>IL</sub>	—	—	0.3V <sub>DD</sub>	V	
Input Current	I <sub>IN</sub>	—	—	±5	µA	SDA and SCL only

# Multi-Channel Low-Voltage Remote Di...

## Electrical Characteristics

.....continued

Parameters	Sym.	Min.	Typ.	Max.	Units	Conditions
Output (SDA only)						
Low-Level Voltage	$V_{OL}$	—	—	0.4	V	$I_O = 20 \text{ mA}$ , $V_{DD} = 1.7\text{V to } 3.6\text{V}$
High-Level Current (leakage)	$I_{OH}$	—	—	1	$\mu\text{A}$	$V_{OH} = V_{DD}$
Low-Level Current	$I_{OL}$	—	—	20	mA	$V_{OL} = 0.4\text{V}$ , $V_{DD} = 1.65\text{V to } 3.6\text{V}$
Capacitance	$C_{IN}$	—	5	—	pF	
SDA and SCL Inputs						
Hysteresis	$V_{HYST}$	—	$0.05V_{DD}$	—	V	

**Table 1-2. Thermal Specifications**

Electrical Characteristics: Unless otherwise specified,  $1.62\text{V} \leq V_{DD} \leq 3.6\text{V}$  at  $-40^\circ\text{C} \leq T_A \leq +125^\circ\text{C}$

Parameters	Sym.	Min.	Typ.	Max.	Units	Test Conditions
Temperature Ranges						
Specified Temperature Range	$T_A$	-40	—	+125	$^\circ\text{C}$	
Operating Temperature Range	$T_A$	-40	—	+125	$^\circ\text{C}$	
Storage Temperature Range	$T_A$	-65	—	+125	$^\circ\text{C}$	
Thermal Package Resistances						
Thermal Resistance, 8L-WDFN, 2 x 2 mm	$\theta_{JA}$	—	141.3	—	$^\circ\text{C/W}$	JEDEC 2s2p, board size 76.2 x 114.3 x 1.6 mm, one thermal via, airflow = 0 m/s.
Thermal Resistance, 10L-VDFN, 2.5 x 2.0 mm	$\theta_{JA}$	—	78	—	$^\circ\text{C/W}$	

**Table 1-3. SMBUS Module Specifications**

Operating Conditions: unless otherwise indicated,  $1.62\text{V} \leq V_{DD} \leq 3.6\text{V}$  at  $-40^\circ\text{C} \leq T_A \leq +85^\circ\text{C}$

Characteristic	Sym.	Min.	Typ.	Max.	Units	Conditions
SMBus Timing						
Clock Frequency	$f_{SMB}$	10	—	400	kHz	
Spike Suppression	$t_{SP}$	—	—	50	ns	
Bus Free Time Stop to Start	$t_{BUF}$	1.3	—	—	$\mu\text{s}$	
Hold Time: Start	$t_{HD:STA}$	0.6	—	—	$\mu\text{s}$	
Setup Time: Start	$t_{SU:STA}$	0.6	—	—	$\mu\text{s}$	
Setup Time: Stop	$t_{SU:STO}$	0.6	—	—	$\mu\text{s}$	



# Multi-Channel Low-Voltage Remote Di...

## Electrical Characteristics

.....continued

Characteristic	Sym.	Min.	Typ.	Max.	Units	Conditions
Data Hold Time	$t_{HD:DAT}$	0	—	—	$\mu s$	When transmitting to the master
Data Hold Time	$t_{HD:DAT}$	0	—	—	$\mu s$	When receiving from the master
Data Setup Time	$t_{SU:DAT}$	100	—	—	ns	
Clock Low-Period	$t_{LOW}$	1.3	—	—	$\mu s$	
Clock High-Period	$t_{HIGH}$	0.6	—	—	$\mu s$	
Clock/Data Fall-Time	$t_{FALL}$	—	—	300	ns	Min = $20 + 0.1 C_{LOAD}$ ns
Clock/Data Rise-Time	$t_{RISE}$	—	—	300	ns	Min = $20 + 0.1 C_{LOAD}$ ns
Capacitive Load	$C_{LOAD}$	—	—	400	pF	Per bus line
Time-out	$t_{TIMEOUT}$	25	—	35	ms	Disabled by default

**Figure 1-1. SMBus Timing Diagram**



## 2. Typical Operating Curves

**Note:** The graphs and tables provided following this note are a statistical summary based on a limited number of samples and are provided for informational purposes only. The performance characteristics listed herein are not tested or guaranteed. In some graphs or tables, the data presented may be outside the specified operating range (for example, outside specified power supply range) and therefore outside the warranted range.

**Note:** Unless otherwise indicated  $1.65V \leq V_{DD} \leq 3.6V$  at  $-40^{\circ}C \leq T_A \leq +125^{\circ}C$ .

**Figure 2-1. Internal Temperature Error vs. Ambient Temperature ( $V_{DD} = 2.5V$ ,  $T_D = +25^{\circ}C$ , 2N3904)**

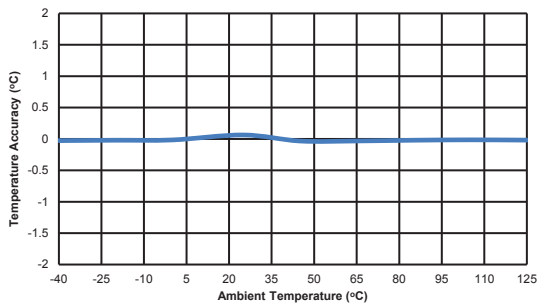

**Figure 2-2. Temperature Accuracy vs. Remote Diode Temperature,  $V_{DD} = 1.8V$**

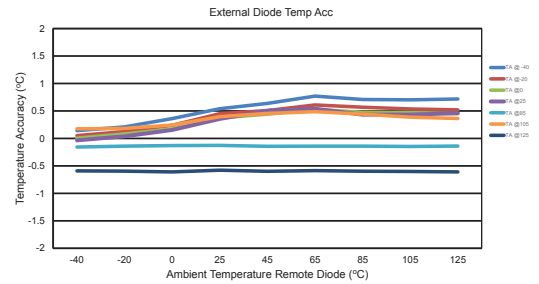

**Figure 2-3. Temperature Error vs. Filter Capacitor ( $V_{DD} = 2.5V$ ,  $T_A = T_D = +25^{\circ}C$ , 2N3904)**

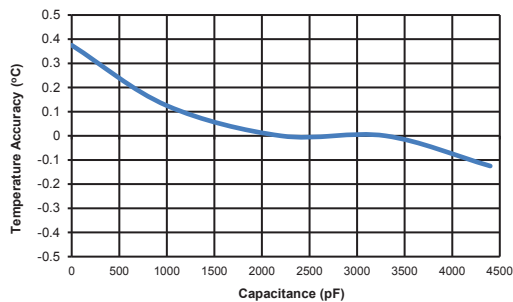

**Figure 2-4. Temperature Error vs. Series Resistance ( $T_A = +25^{\circ}C$ ,  $V_{DD} = 1.8V$ )**

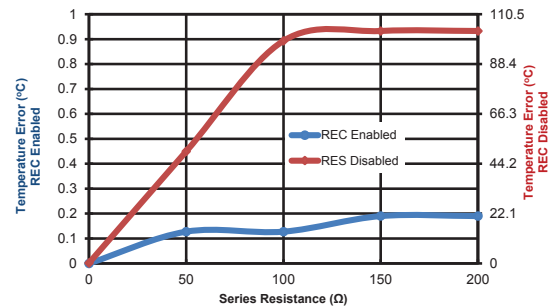

**Figure 2-5.  $I_{DD}$  vs.  $V_{DD}$  Across Temperature**

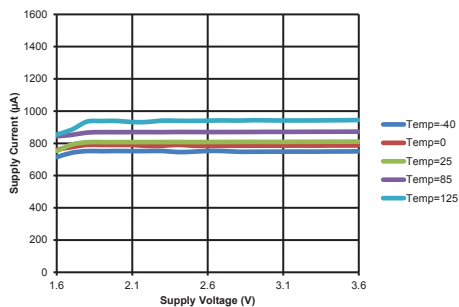

**Figure 2-6. Supply Current vs. Conversion Rate ( $T_A = +25^{\circ}C$ ,  $V_{DD} = 1.8V$ )**

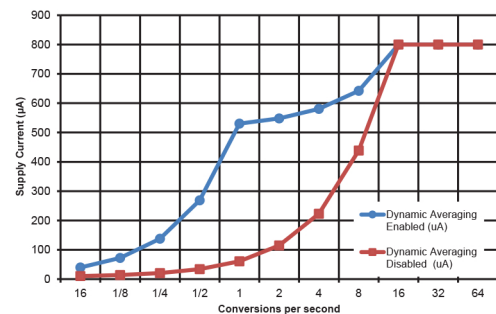

### 3. Pin Descriptions

The EMC1812/13/14/15/33 family has five variants that include features unique to each device. Refer to the table to determine applicability of the pin descriptions.

The description of the pins is listed in the following table:

**Table 3-1. Pin Function Table**

8-Lead WDFN		10-Lead VDFN			Symbol	Type	Description
EMC1812	EMC1833	EMC1813	EMC1814	EMC1815			
1	1	1	1	1	V <sub>DD</sub>	P	Power
2	—	2	2	—	DP, DP1	AIO	Diode 1 connection
3	—	3	3	—	DN, DN1	AIO	Diode 1 connection
—	—	4	—	—	DP2	AIO	Diode 2 connection
—	—	5	—	—	DN2	AIO	Diode 2 connection
5	5	6	6	6	GND	P	Ground
4	4	7	7	7	$\overline{\text{THERM}}/\text{ADDR}$	OD	Thermal alert
6	6	8	8	8	$\overline{\text{ALERT}}/\overline{\text{THERM2}}$	OD	I <sup>2</sup> C $\overline{\text{ALERT}}$ pin
7	7	9	9	9	SDA	OD	I <sup>2</sup> C data
8	8	10	10	10	SCL	OD	I <sup>2</sup> C clock
—	—	—	4	—	DP2/DN3	AIO	Diode 2/3 connection
—	—	—	5	—	DN2/DP3	AIO	Diode 2/3 connection
—	2	—	—	2	DP1/DN2	AIO	Diode 1/2 connection
—	—	—	—	4	DP3/DN4	AIO	Diode 3/4 connection
—	—	—	—	5	DN3/DP4	AIO	Diode 3/4 connection
—	3	—	—	3	DN1/DP2	AIO	Diode 1/2 connection
9	9	11	11	11	EP	P	Exposed Thermal Pad

The pin types are described in the following table:

**Table 3-2. Pin Types**

Pin Type	Description
AIO	Analog Input/Output. This pin is used as an I/O for analog signals.
OD	Open-Drain Digital Output. This pin is used as a digital output. It is open-drain and requires a pull-up resistor.
P	This pin is used to supply power or ground to the device.

### 3.1 Power Supply ( $V_{DD}$ )

This pin is used to supply power to the device.

### 3.2 Diode 1 Pair (DN1/DP1)

Remote Diode 1 anode (DP1) and cathode (DN1) pins.

### 3.3 THERM LIMIT ALERT ( $\overline{THERM/ADDR}$ )

This pin asserts low when the hardware-set THERM limit threshold is exceeded by one of the temperature sensors. The assertion of this signal cannot be controlled or masked by register setting. If enabled, the SMBus slave address is set by the pull-up resistor on this pin.

### 3.4 Ground (GND)

This pin is used to ground the device.

### 3.5 Maskable ALERT ( $\overline{ALERT/THERM2}$ )

This pin asserts when a diode temperature exceeds the ALERT threshold. This pin may be masked by register settings.

### 3.6 SMBus/I<sup>2</sup>C Data (SDA)

This is the open-drain, bidirectional data pin for SMBus communication.

### 3.7 DP/DP1

- DP/DP1: DP and DP1 anode

### 3.8 DN/DN1

- DN/DN1: DN and DN1 cathode

### 3.9 DP2

- DP2: DP2 anode

### 3.10 DN2

- DN2: DN2 cathode

### 3.11 Anti-Parallel Diode Pair (DP2/DN3 and DN2/DP3)

- DP2/DN3: DP2 anode and DN3 cathode

- DN2/DP3: DN2 cathode and DP3 anode

### 3.12 Anti-Parallel Diode Pair (DP1/DN2 and DN1/DP2)

- DP1/DN2: DP1 anode and DN2 cathode
- DN1/DP2: DN1 cathode and DP2 anode

### 3.13 Anti-Parallel Diode Pair (DP3/DN4 and DN3/DP4)

- DP3/DN4: DP3 anode and DN4 cathode
- DN3/DP4: DN3 cathode and DP4 anode

### 3.14 SMBus Clock (SCL)

This is the SMBus/I<sup>2</sup>C input clock pin for SMBus communication.

### 3.15 Exposed Thermal Pad (EP)

There is no internal connection between the Exposed Thermal Pad (EP) and the GND pin. They must be connected to the same electric potential on the Printed Circuit Board (PCB). Grounding is recommended for mechanical support.

### 4. Detailed Description

The EMC1812/13/14/15/33 devices monitor one internal diode and up to four externally-connected temperature diodes.

Thermal management is performed in cooperation with a host device. This consists of the host reading the temperature data of both the external and internal temperature diodes of the EMC1812/13/14/15/33 and using that data to manage thermal events or to control the speed of one or more fans.

This device family introduces rate of change temperature measurement with associated alerts. This provides a preemptive system alert and another protective measurement layer to catch and manage variable system temperatures. Resistance Error Correction automatically eliminates the temperature error caused by series resistance. This feature allows for routing long traces and off-board connections with wires, if desired. Automatic beta compensation eliminates the need for substrate diode and transistor configurations.

The EMC1812/13/14/15/33 family has two levels of monitoring. The first provides a maskable  $\overline{\text{ALERT}}$  signal to the host when the measured temperatures exceed user programmable limits. This allows the EMC1812/13/14/15/33 to be used as an independent thermal watchdog to warn the host of temperature hot spots without direct control by the host. The second level of monitoring provides a nonmaskable interrupt on the  $\overline{\text{THERM}}$  pin if the measured temperatures meet or exceed a second programmable limit.

The EMC1812 is a single-channel remote temperature sensor, while the EMC1813 is a dual-channel remote temperature sensor. The remote channels for this selection of devices can support substrate diodes, discrete diode connected transistors, or CPU/GPU thermal diodes.

The EMC1814 supports anti-parallel diode (APD) only on one channel. For the channel that does not support APD functionality, substrate diodes, discrete diode-connected transistors or CPU/GPU thermal diodes are supported. For the channel that supports APD, only discrete diode connected transistors may be implemented. However, if APD is disabled on the EMC1814, then the channel that supports APD will be functional with substrate diodes, discrete diode connected transistors and CPU/GPU thermal diodes.

The EMC1815 and EMC1833 support APD on all channels. When APD is enabled, the channels support only diode connected transistors. If APD is disabled, then the channels will support substrate transistors, discrete diode connected transistors and CPU/GPU thermal diodes.

**Note:** Disabling APD functionality to implement substrate diodes on devices that support APD eliminates the benefit of APD (two diodes on one channel).

## 5. System Block Diagram

The figure below shows a system-level block diagram of the EMC1812/13/14/15/33.

**Figure 5-1. EMC1812/13/14/15/33 System Diagram**



### 5.1 Temperature Measurement

The EMC1812/13/14/15/33 device family can monitor the temperature of up to four externally-connected diodes. Each external diode channel is configured with Resistance Error Correction and Beta Compensation based on user settings and system requirements.

The devices contain programmable high, low and therm limits for all measured temperature channels. If the measured temperature goes below the low limit or above the high limit, the  $\overline{\text{ALERT}}$  pin can be asserted (based on user settings). If the measured temperature meets or exceeds the therm limit, the  $\overline{\text{THERM}}$  pin is asserted unconditionally, providing two tiers of temperature detection.

### 5.2 Temperature Measurement Results and Data

The temperature measurement results are stored in the internal and external temperature registers. These are then compared with the values stored in the high- and low-limit registers. Both external and internal temperature measurements are stored in 11-bit format with the eight Most Significant bits (MSb) stored in a high-byte register and the three Least Significant bits (LSb) stored in the three MSB positions of the low-byte register. All other bits of the low-byte register are set to zero.

The EMC1812/13/14/15/33 family has two selectable temperature ranges. The default range is from 0°C to +127°C and the temperature is represented as a binary number able to report a temperature from 0°C to +127.875°C in 0.125°C steps.

The extended range is an extended temperature range from -64°C to +191°C. The data format is a binary number offset by 64°C. The extended range is used to measure temperature diodes with a large known offset (such as CPU/GPU processor diodes) where the diode temperature plus the offset would be equivalent to a temperature higher than +127°C.

The following table shows the default and extended range formats.

# Multi-Channel Low-Voltage Remote Di... System Block Diagram

**Table 5-1. Temperature Data Format**

Temperature (°C)	Default Range 0°C to 127°C	Extended Range -64°C to 191°C
Diode Fault	000 0000 0000	000 0000 0000
-64	000 0000 0000	000 0000 0000 (Note 1)
-1	000 0000 0000	001 1111 1000
0	000 0000 0000 (Note 2)	010 0000 0000
0.125	000 0000 0001	010 0000 0001
1	000 0000 1000	010 0000 1000
64	010 0000 0000	100 0000 0000
65	010 0000 1000	100 0000 1000
127	011 1111 1000	101 1111 1000
127.875	011 1111 1111	101 1111 1111
128	011 1111 1111 (Note 3)	110 0000 0000
190	011 1111 1111	111 1111 0000
191	011 1111 1111	111 1111 1000
≥ 191.875	011 1111 1111	111 1111 1111 (Note 4)

**Note:**

1. In the extended range, all temperatures below -64°C are reported as -64°C.
2. In Default mode, all temperatures below 0°C are reported as 0°C.
3. For the default range, all temperatures above +127.875°C are reported as +127.875°C.
4. For the extended range, all temperatures above +191.875°C are reported as +191.875°C.

## 5.3 Limit Registers

The device contains both high and low limits for all temperature channels. If the measured temperature exceeds the high limit, then the corresponding Status bit is set and the  $\overline{\text{ALERT}}$  pin is asserted. Likewise, if the measured temperature is less than or equal to the low limit, the corresponding Status bit is set and the  $\overline{\text{ALERT}}$  pin is asserted.

The data format for the limits must match the selected data format for the temperature so that, if the extended temperature range is used, the limits must be programmed in the extended data format.

The limit registers with multiple addresses are fully accessible at either address.

When the device is in the Standby state, updating the limit registers will have no effect until the next conversion cycle occurs. This can be initiated via a write to the ONE SHOT Register (Address 0Fh; [ONE SHOT](#)) or by clearing the RUN/STANDBY bit (see [CONFIG](#), Address 03h).



### 5.4 Limit Register Interaction

The various Limit registers in the device interact based on both external conditions present on the diode pins, as well as changes in register bits in the I<sup>2</sup>C interface.

#### 5.4.1 High Limit Register

The High Limit Status register contains the Status bits that are set when a temperature channel high limit is exceeded. If any of these bits are set, then the HIGH Status bit in the STATUS register is set. Reading from the High Limit Status register clears all bits. Reading from the register will also clear the HIGH Status bit in the STATUS register.

The  $\overline{\text{ALERT}}$  pin will be set if the programmed number of consecutive alert counts has been met and any of these Status bits are set.

The Status bits remain set until a read is performed, unless the  $\overline{\text{ALERT}}$  pin is configured as a comparator output (see [5.5.2 ALERT/THERM2 Pin in Therm Mode](#)).

#### 5.4.2 Low Limit Register

The Low Limit Status register contains the Status bits that are set when a temperature channel drops below the low limit. If any of these bits are set, then the LOW Status bit in the STATUS register is set. Reading from the Low Limit Status register clears all bits.

The  $\overline{\text{ALERT}}$  pin will be set if the programmed number of consecutive alert counts has been met and any of these Status bits are set.

The Status bits will remain set until a read is performed, unless the  $\overline{\text{ALERT}}$  pin is configured as a comparator output (see [5.5.2 ALERT/THERM2 Pin in Therm Mode](#)).

#### 5.4.3 THERM Limit Register

The Therm Limit registers are used to determine whether a critical thermal event has occurred. If the measured temperature exceeds the therm limit, the  $\overline{\text{THERM}}$  pin is asserted. The limit setting must match the chosen data format of the temperature reading registers.

Unlike the  $\overline{\text{ALERT}}$  pin, the  $\overline{\text{THERM}}$  pin cannot be masked. Additionally, the  $\overline{\text{THERM}}$  pin is released once the temperature drops below the corresponding threshold, minus the Therm Hysteresis.

### 5.5 $\overline{\text{ALERT/THERM2}}$ Output

The  $\overline{\text{ALERT/THERM2}}$  pin is an open-drain output and requires a pull-up resistor to  $V_{DD}$  and has two modes of operation: Interrupt mode and Comparator mode. The mode of the  $\overline{\text{ALERT/THERM2}}$  output is selected through the  $\overline{\text{ALERT/THERM2}}$  bit (see [CONFIG](#), Address 03h).

#### 5.5.1 $\overline{\text{ALERT/THERM2}}$ Pin Interrupt Mode

When configured to operate in Interrupt mode, the  $\overline{\text{ALERT/THERM2}}$  pin asserts low when an out-of-limit measurement (less than or equal to the low limit or greater than the high limit) is detected on any diode or when a Diode Fault is detected. The  $\overline{\text{ALERT/THERM2}}$  pin will remain asserted as long as an out-of-limit condition remains. Once the out-of-limit condition has been removed, the  $\overline{\text{ALERT/THERM2}}$  pin remains asserted until the appropriate Status bits are cleared.

The  $\overline{\text{ALERT/THERM2}}$  pin can be masked by setting the MASK\_ALL bit. Once the  $\overline{\text{ALERT/THERM2}}$  pin has been masked, it is deasserted and remains as such until the MASK\_ALL bit is cleared by the user. Any interrupt conditions that occur while the  $\overline{\text{ALERT/THERM2}}$  pin is masked causes the STATUS register to be updated normally. There are also individual channel masks (see [6.10.20 DIODE FAULT MASK](#).)

# Multi-Channel Low-Voltage Remote Di...

## System Block Diagram

The  $\overline{\text{ALERT/THERM2}}$  pin is used as an interrupt signal or as an I<sup>2</sup>C Alert signal that allows an SMBus/I<sup>2</sup>C slave to communicate an error condition to the master. One or more  $\overline{\text{ALERT/THERM2}}$  outputs can be hard-wired together.

### 5.5.2 $\overline{\text{ALERT/THERM2}}$ Pin in Therm Mode

When the  $\overline{\text{ALERT/THERM2}}$  pin is configured to operate in Therm mode, it becomes asserted if any of the measured temperatures exceed the respective high limit. The  $\overline{\text{ALERT/THERM2}}$  pin remains asserted until all temperatures drop below the corresponding high limit, minus the Therm Hysteresis value.

When the  $\overline{\text{ALERT/THERM2}}$  pin is asserted in Therm mode, the corresponding high limit Status bits are set. Reading these bits do not clear them until the  $\overline{\text{ALERT/THERM2}}$  pin is deasserted. Once the  $\overline{\text{ALERT/THERM2}}$  pin is deasserted, the Status bits are automatically cleared.

The MASK\_ALL bit does not block the  $\overline{\text{ALERT/THERM2}}$  pin in this mode; however, the individual channel masks prevent the respective channel from asserting the  $\overline{\text{ALERT/THERM2}}$  pin.

### 5.6 $\overline{\text{THERM}}$ Output

The  $\overline{\text{THERM}}$  output is asserted independently of the  $\overline{\text{ALERT}}$  output and cannot be masked. Whenever any of the measured temperatures exceed the user-programmed therm limit values for the programmed number of consecutive measurements, the  $\overline{\text{THERM}}$  output is asserted. Once it has been asserted, it remains asserted until all measured temperatures drop below the therm limit, minus the Therm Hysteresis (also programmable).

When the  $\overline{\text{THERM}}$  pin is asserted, the Therm Status bits are likewise set. Reading these bits does not clear them until the  $\overline{\text{THERM}}$  pin is deasserted. Once the  $\overline{\text{THERM}}$  pin is deasserted, the  $\overline{\text{THERM}}$  Status bits are automatically cleared.

### 5.7 $\overline{\text{THERM}}$ Pin Address Decoding

The address decode is performed by pulling known currents from the V<sub>DD</sub> pin through the external resistor, causing the pin voltage to drop based on the respective current/resistor relationship. This pin voltage is compared against a threshold that determines the value of the pull-up resistor.

The EMC1812/13/14/15/33-A SMBus slave address is determined by the pull-up resistor on the THERMADDR pin, as shown in the following table.

**Table 5-2. I<sup>2</sup>C/SMBus Address Decode**

Pull-Up Resistor on $\overline{\text{THERM}}$ pin ( $\pm 5\%$ )	SMBus Address
4.7 k $\Omega$	1111_100 (r/ $\overline{w}$ )b
6.8 k $\Omega$	1011_100 (r/ $\overline{w}$ )b
10 k $\Omega$	1001_100 (r/ $\overline{w}$ )b
15 k $\Omega$	1101_100 (r/ $\overline{w}$ )b
22 k $\Omega$	0011_100 (r/ $\overline{w}$ )b
33 k $\Omega$	0111_100 (r/ $\overline{w}$ )b

## 5.8 External Diode Connections

The EMC1812 can be configured to measure a CPU substrate transistor, a discrete 2N3904 thermal diode, or an CPU/GPU processor diode. The diodes can be connected as indicated in the figure below.

The EMC1813 can be configured to measure a CPU substrate transistor, a discrete 2N3904 thermal diode, or an CPU/GPU processor diode on the External Diode 1 or External Diode 2 channels. For the EMC1814, External Diode 2 and External Diode 3 channels are configured to measure a pair of discrete anti-parallel diodes (shared on pins DP2 and DN2). The supported configurations for the external diode channels are shown in the following figure.

**Figure 5-2. Diode Configurations**



## 5.9 Power States

The EMC1812/13/14/15/33 devices have two power states: Active and Standby.

- **Active (Run)** - In this state, the ADC is converting on all temperature channels at the programmed conversion rate. The temperature data is updated at the end of every conversion and the limits are checked. In the Active state, writing to the One-shot register has no effects.
- **Standby (One-shot)** - While the device is in Standby, the host can initiate a conversion cycle on demand. After the conversion cycle is complete, the device returns to the Standby state.

## 5.10 Conversion Rates

The EMC1812/13/14/15/33 devices may be configured for different conversion rates based on the system requirements. The default conversion rate is four conversions per second. Other available conversion rates are shown in the Conversion Rate table.

**Table 5-3. Conversion Rate**

CONV<3:0>					Conversions/ Second
HEX	3	2	1	0	
0h	0	0	0	0	1/16
1h	0	0	0	1	1/8
2h	0	0	1	0	1/4
3h	0	0	1	1	1/2
4h	0	1	0	0	1
5h	0	1	0	1	2
6h	0	1	1	0	4 (default)
7h	0	1	1	1	8
8h	1	0	0	0	16
9h	1	0	0	1	32
Ah	1	0	1	0	64
Bh - Fh	All others				1

## 5.11 Dynamic Averaging

Dynamic averaging causes the EMC1812/13/14/15/33 devices to measure the external diode channels for an extended time based on the selected conversion rate. This functionality can be disabled for increased power savings at the lower conversion rates. When dynamic averaging is enabled, the devices automatically adjust the sampling and measurement time for the external diode channels. This allows the devices to average 2x to 16x longer than the normal 11-bit operation (nominally 21 ms per channel) while still maintaining the selected conversion rate. The benefits of dynamic averaging are improved noise rejection due to the longer integration time as well as less random variation of the temperature measurement.

When enabled, the dynamic averaging applies when a one-shot command is issued. The devices perform the desired averaging during the one-shot operation according to the selected conversion rate.

When enabled, the dynamic averaging affects the average supply current based on the chosen conversion rate as shown in the following table.

**Table 5-4. Supply Current vs. Conversion Rate for EMC1815**

Conversion Rate	Average Supply Current		Averaging Factor (based on 11-bit operation)	
	Dynamic Averaging State			
	Enabled (default)	Disabled	Enabled (default)	Disabled
1/16s	144 $\mu$ A	80 $\mu$ A	16x	1x
1/8s	213 $\mu$ A	86 $\mu$ A	16x	1x
1/4s	351 $\mu$ A	97 $\mu$ A	16x	1x

# Multi-Channel Low-Voltage Remote Di...

## System Block Diagram

.....continued

Conversion Rate	Average Supply Current		Averaging Factor (based on 11-bit operation)	
	Dynamic Averaging State			
	Enabled (default)	Disabled	Enabled (default)	Disabled
1/2s	627 $\mu$ A	120 $\mu$ A	16x	1x
1/s	637 $\mu$ A	164 $\mu$ A	16x	1x
2/s	659 $\mu$ A	253 $\mu$ A	16x	1x
4/s (default)	703 $\mu$ A	432 $\mu$ A	8x	1x
8/s	790 $\mu$ A	790 $\mu$ A	4x	1x
16/s	830 $\mu$ A	830 $\mu$ A	2x	1x
32/s	830 $\mu$ A	830 $\mu$ A	1x	1x
64/s	1065 $\mu$ A	1065 $\mu$ A	0.5x	0.5x

### 5.12 Digital Filter

To reduce the effect of noise and temperature spikes on the reported temperature, the External Diode channel uses a programmable digital filter. This filter can be configured as Level 1, Level 2, or Disabled (default). The typical filter performance is shown in the figures below. The Filter Configuration register controls the digital filter on the External Diode 1 channel.

To reduce complexity, the digital filter only applies to the External Diode channel 1 and 2. Furthermore, this is only the case when APD is not enabled for a given channel. It applies after the digital block has taken the appropriate 11 bits based on the dynamic averaging.

**Table 5-5. Filter Settings**

FILTER<1:0>		Averaging
1	0	
0	0	Disabled (default)
0	1	Level 1 ( <a href="#">Note 1</a> )
1	0	Level 1 ( <a href="#">Note 1</a> )
1	1	Level 2 ( <a href="#">Note 2</a> )

**Note:**

- Filtering Level 1 corresponds to 4x attenuation of a temperature spike.
- Filtering Level 2 corresponds to 8x attenuation of a temperature spike.

**Figure 5-3. Temperature Filter Step Response**



**Figure 5-4. Temperature Filter Impulse Response**



The filter consists of a running average on the external diode channel. The Level 1 filter is a running average of 4x while the Level 2 filter is a running average of 8x. For the first measurement immediately after power-up, the filter will be filled with the results of the first measurement. After this, the filter is operated normally. Any temperature comparisons are done with the filtered results that are stored in the user register.

## 5.13 Beta Compensation

The EMC1812/13/14/15/33 devices are configured to monitor the temperature of basic diodes (for example 2N3904) or CPU thermal diodes. It automatically detects the type of external diode (CPU diode or diode connected transistor) and determines the optimal setting to reduce temperature errors introduced by beta variation. Compensating for this error is also known as implementing the transistor or BJT model for temperature measurement.

For discrete transistors configured with the collector and base shorted together, the beta is generally sufficiently high, such that the percent change in beta variation is very small. For example, a 10% variation in beta for two forced emitter currents with a transistor whose ideal beta is 50 would contribute approximately 0.25°C error at +100°C. However, for substrate transistors where the base-emitter junction is used for temperature measurement and the collector is tied to the substrate, the proportional beta variation will cause large errors. For example, a 10% variation in beta for two forced emitter currents, with a transistor whose ideal beta is 0.5, would contribute approximately +8.25°C error at +100°C.

For the EMC1814 and EMC1815 devices, the External Diode 2/3 (EMC1814) and External Diode channels 3/4 do not support beta compensation.

At the beginning of every conversion, the optimal beta compensation factor setting is determined and applied. The `BETA(N) <2:0>` bits are automatically updated to indicate the current setting. This is the

# Multi-Channel Low-Voltage Remote Di...

## System Block Diagram

default for EMC1813. This is the default for EMC1814 for External Diode 1 only and it is disabled and cannot be enabled for External Diode 2 or 3. If the auto-detection circuitry is disabled, these bits will determine the beta configuration setting that is used for their respective channels.

It is recommended to be cautious when setting the  $BETA(N) \langle 2:0 \rangle$  bits when the auto-detection circuitry is disabled. If the beta compensation factor is set at a beta value that is higher than the transistor beta, the circuit may generate measurement errors. When measuring a discrete thermal diode (such as 2N3904) or a CPU diode that functions like a discrete thermal diode (such as an CPU/GPU processor diode), the  $BETA(N) \langle 2:0 \rangle$  bits should be set to 111b.

**Table 5-6. CPU Beta Values**

DI_BETA<3:0>				Minimum Beta
3	2	1	0	
0	0	0	0	0.050
0	0	0	1	0.066
0	0	1	0	0.087
0	0	1	1	0.114
0	1	0	0	0.150
0	1	0	1	0.197
0	1	1	0	0.260
0	1	1	1	0.342
1	0	0	0	0.449
1	0	0	1	0.591
1	0	1	0	0.778
1	0	1	1	1.024
1	1	0	0	1.348
1	1	0	1	1.773
1	1	1	0	2.333
1	1	1	1	Diode Mode

### 5.14 Resistance Error Correction (REC)

Parasitic resistance, in series with the external diodes, limits the accuracy obtainable from temperature measurement devices. The voltage developed across this resistance by the switching diode currents causes the temperature measurement to read higher than the true temperature. Contributors to series resistance are PCB trace resistance, on die (i.e., on the processor) metal resistance, bulk resistance in the base and emitter of the temperature transistor. Typically, the error caused by series resistance is  $+0.7^{\circ}\text{C}/\Omega$ . The EMC1812/13/14/15/33 devices automatically correct up to 100  $\Omega$  of series resistance.

## 5.15 Programmable External Diode Ideality Factor

The EMC1812/13/14/15/33 device family is designed for external diodes with an ideality factor of 1.008. Not all external diodes, processor or discrete, will have this exact value. This variation of the ideality factor introduces errors in the temperature measurement which must be corrected for. This correction is typically done using programmable offset registers. Since an ideality factor mismatch introduces an error that is a function of temperature, this correction is only accurate within a small range of temperatures. To provide maximum flexibility to the user, the EMC1812/13/14/15/33 devices provides a 6-bit register for each external diode where the ideality factor of the diode used is programmed to eliminate errors across all temperatures.

When monitoring a substrate transistor or CPU diode and beta compensation is enabled, the ideality factor should not be adjusted. Beta compensation automatically corrects for most ideality errors.

When measuring a 65 nm Intel<sup>®</sup> CPU, the Ideality Setting should be the default 12h. When measuring a 45 nm Intel CPU, the Ideality Setting should be 15h.

These registers store the ideality factors that are applied to the external diodes. The following table defines each setting and the corresponding ideality factor. Since beta compensation and Resistance Error Correction automatically correct for most diode ideality errors, it is not recommended that these settings be updated without consulting Microchip.

**Table 5-7. Ideality Factor Look-Up Table (Diode Model)**

Setting	Factor	Setting	Factor	Setting	Factor
08h	0.9949	18h	1.0159	28h	1.0371
09h	0.9962	19h	1.0172	29h	1.0384
0Ah	0.9975	1Ah	1.0185	2Ah	1.0397
0Bh	0.9988	1Bh	1.0200	2Bh	1.0410
0Ch	1.0001	1Ch	1.0212	2Ch	1.0423
0Dh	1.0014	1Dh	1.0226	2Dh	1.0436
0Eh	1.0027	1Eh	1.0239	2Eh	1.0449
0Fh	1.0040	1Fh	1.0253	2Fh	1.0462
10h	1.0053	20h	1.0267	30h	1.0475
11h	1.0066	21h	1.0280	31h	1.0488
12h	1.0080	22h	1.0293	32h	1.0501
13h	1.0093	23h	1.0306	33h	1.0514
14h	1.0106	24h	1.0319	34h	1.0527
15h	1.0119	25h	1.0332	35h	1.0540
16h	1.0133	26h	1.0345	36h	1.0553
17h	1.0146	27h	1.0358	37h	1.0566



# Multi-Channel Low-Voltage Remote Di...

## System Block Diagram

For CPU substrate transistors that require the BJT transistor model, the ideality factor behaves slightly differently than for discrete diode-connected transistors. Refer to the following when using a CPU substrate transistor.

**Table 5-8. Substrate Diode Ideality Factor Look-Up Table (BJT Model)**

Setting	Factor	Setting	Factor	Setting	Factor
08h	0.9869	18h	1.0079	28h	1.0291
09h	0.9882	19h	1.0092	29h	1.0304
0Ah	0.9895	1Ah	1.0105	2Ah	1.0317
0Bh	0.9908	1Bh	1.0120	2Bh	1.0330
0Ch	0.9921	1Ch	1.0132	2Ch	1.0343
0Dh	0.9934	1Dh	1.0146	2Dh	1.0356
0Eh	0.9947	1Eh	1.0159	2Eh	1.0369
0Fh	0.9960	1Fh	1.0173	2Fh	1.0382
10h	0.9973	20h	1.0187	30h	1.0395
11h	0.9986	21h	1.0200	31h	1.0408
12h	1.0000	22h	1.0213	32h	1.0421
13h	1.0013	23h	1.0226	33h	1.0434
14h	1.0026	24h	1.0239	34h	1.0447
15h	1.0039	25h	1.0252	35h	1.0460
16h	1.0053	26h	1.0265	36h	1.0473
17h	1.0066	27h	1.0278	37h	1.0486

## 5.16 Diode Faults

The EMC1812/13/14/15/33 devices detect an open on the DP and DN pins, and a short across the DP and DN pins. For each temperature measurement made, the device checks for a Diode Fault on the external diode channel(s). When a Diode Fault is detected, the  $\overline{\text{ALERT}}$  pin asserts (unless masked) and the temperature data reads 00h in the MSB and LSB registers (note that the low limit is not be checked). A Diode Fault is defined as one of the following: an open between DP and DN, a short from  $V_{DD}$  to DP, or a short from  $V_{DD}$  to DN.

If a short occurs across DP and DN or a short occurs from DP to GND, the low limit Status bit is not set and the  $\overline{\text{ALERT}}$  pin does not assert. This condition is indistinguishable from a temperature measurement of 0.000°C (-64°C in extended range) resulting in temperature data of 00h in the MSB and LSB registers.

If a short from DN to GND occurs (with a diode connected), temperature measurements will continue as normal with no alerts.

## 5.17 Consecutive Alerts

The EMC1812/13/14/15/33 device family contains multiple consecutive alert counters. One set of counters applies to the  $\overline{\text{ALERT}}$  pin and the second set of counters applies to the  $\overline{\text{THERM}}$  pin. Each temperature measurement channel has a separate consecutive alert counter for each of the  $\overline{\text{ALERT}}$  and  $\overline{\text{THERM}}$  pins. All counters are user programmable and determine the number of consecutive measurements that a temperature channel(s) must be out-of-limit or reporting a Diode Fault before the corresponding pin is asserted.

The Consecutive Alert register determines how many times an out-of-limit error or Diode Fault must be detected in consecutive measurements before the  $\overline{\text{ALERT}}$  or  $\overline{\text{THERM}}$  pin is asserted.

An out-of-limit condition (for example, HIGH, LOW, or FAULT) occurring on the same temperature channel in consecutive measurements will increment the consecutive alert counter. The counters will also be reset if no out-of-limit condition or Diode Fault condition occurs in a consecutive reading.

When the  $\overline{\text{ALERT}}$  pin is configured as an interrupt and when the consecutive alert counter reaches its programmed value, the following occurs: the Status bit(s) for that channel and the last error condition(s) (for example, E1HIGH, or E2LOW and/or E2FAULT) are set to '1', the  $\overline{\text{ALERT}}$  pin is asserted, the consecutive alert counter is cleared and measurements continue to be performed.

When the  $\overline{\text{ALERT}}$  pin is configured as a comparator, the consecutive alert counter will ignore Diode Fault and low limit errors and only increment if the measured temperature exceeds the high limit. Additionally, once the consecutive alert counter reaches the programmed limit, the  $\overline{\text{ALERT}}$  pin is asserted, but the counter does not reset. It remains set until the temperature drops below the high limit minus the Therm Hysteresis value.

Channels that are not enabled are not included in the consecutive alert pin checking. The signal logic chain is: Limit → Counter → Status → Mask → Pin ( $\overline{\text{THERM}}$  and  $\overline{\text{ALERT}}$ ).

For example, if the  $\text{CALRT}<2:0>$  bits are set for four consecutive alerts on an EMC1812/13/14/15/33 device, the high limits are set at +70°C and none of the channels are masked, then the  $\overline{\text{ALERT}}$  pin is asserted after the following five measurements:

- Internal Diode reads +71°C and both the external diodes read +69°C. Consecutive alert counter for INT is incremented to 1.
- Both the Internal Diode and the External Diode 1 read +71°C and External Diode 2 reads +68°C. Consecutive alert counter for INT is incremented to 2 and for EXT1 is set to 1.
- The External Diode 1 reads +71°C and both Internal Diode and External Diode 2 read +69°C. Consecutive alert counters for INT and EXT2 are cleared and EXT1 is incremented to 2.
- The Internal Diode reads +71°C and both external diodes read +71°C. Consecutive alert counter for INT is set to 1, EXT2 is set to 1 and EXT1 is incremented to 3.
- The Internal Diode reads +71°C and both external diodes read +71°C. Consecutive alert counter for INT is incremented to 2, EXT2 is set to 2 and EXT1 is incremented to 4. The appropriate Status bits are set for EXT and the  $\overline{\text{ALERT}}$  pin is asserted. EXT1 counter is reset to 0 and all other counters hold the last value until the next temperature measurement.

All temperature channels use this value to set the respective counters. The consecutive Therm counter is incremented whenever any measurement exceeds the corresponding Therm limit.

If the temperature drops below the Therm limit, the counter is reset. If a number of consecutive measurements above the Therm limit occurs, the  $\overline{\text{THERM}}$  pin is asserted low.

Once the  $\overline{\text{THERM}}$  pin has been asserted, the consecutive Therm counter will not reset until the corresponding temperature drops below the Therm limit minus the Therm Hysteresis value.

The bits are decoded as shown in the table below. The default setting is four consecutive out-of-limit conversions.

All temperature channels use this value to set the respective counters. The bits are decoded as shown in the table below. The default setting is 1 consecutive out-of-limit conversion.

When the  $\overline{\text{ALERT}}$  pin is in Comparator mode, the low limit and Diode Fault will bypass the consecutive alert counter and set the appropriate Status bits, but will NOT assert the  $\overline{\text{ALERT}}$  pin.

When a value is written to [6.10.21 CONSEC ALERT](#) (Address 22h) that is not defined below, the command is ignored and the last valid value is maintained.

**Table 5-9. Consecutive  $\overline{\text{ALERT}}$ /  $\overline{\text{THERM}}$  Settings**

2	1	0	Number of consecutive Out-of-Limit measurements
0	0	0	1 (default for $\text{CALRT}<2:0>$ )
0	0	1	2
0	1	1	3
1	1	1	4 (default for $\text{CTHRM}<2:0>$ )

## 5.18 “Hottest Of” Comparison

At the end of every measurement cycle, the EMC1812/13/14/15/33 devices compare all of the user-selectable internal and external diode channels to determine which of these channels is reporting the hottest temperature. The hottest temperature is stored in the Hottest Temperature registers and the appropriate Status bit is set in the Hottest Status register. If multiple temperature channels measure the same temperature and are equal to the hottest temperature, the hottest status will be displayed for all selected temperature channels with the hottest temperature measurement.

As an optional feature, the EMC1812/13/14/15/33 devices can also flag an event if the hottest temperature channel changes by enabling the REMHOT (Remember Hottest) bit (see [6.10.43 HOTTEST CONFIG](#)). For example, suppose that external diode channels 1, 3 and 4 are programmed to be compared in the “Hottest Of” Comparison. If the External Diode 1 channel reports the hottest temperature of the three, its temperature is copied into the Hottest Temperature registers (in addition to the External Diode 1 Temperature registers) and it is flagged in the Hottest Status bit. If, on the next measurement, the External Diode 3 channel temperature has increased such that it is now the hottest temperature, the EMC1812/13/14/15/33 devices can flag this event as an interrupt condition and assert the  $\overline{\text{ALERT}}$  pin.

## 5.19 Rate of Change

The Rate of Change (ROC) function approximates the derivative of the temperature using a difference equation. The equation below is the basis for calculation.

The ROC can be enabled for the first two standard diode connections. If Diode 2 is an anti-parallel connected diode, the ROC feature is applied to diode 3. For the EMC1833 the ROC only applies to External Diode 1.

### Rate of Change

$$\frac{\Delta T}{\Delta t} = \frac{[T(t_{\max}) - T(t_0)] \times \text{gain}}{(\text{sample} - 1)}$$

Where:

$T(t_{\max})$	=	temperature at the end of the interval
$T(t_0)$	=	temperature at the beginning of the interval

The ROC period ( $T_0$  to  $T_{\max}$ ) can be approximated by the combination of conversion rate (see [Table 5-3](#)) and ROC samples (address 43h, 48h). The table below shows the samples defined by the bit settings.

For example, setting the conversion rate to 1 conversion per second and the number of ROC samples to 65 samples would give an approximate ROC period of 65 seconds or approximately 1 minute.

The gain applied to the result is stored in [6.10.27 ROC GAIN](#) (Address 3Dh). The effective gains are shown in the register definition.

Since this is sampled over time, there is a bit for each channel that indicates a change in slope has occurred. These bits (one for each channel) assert when the result of two consecutive sample differences exceeds the threshold limit as defined by the Hysteresis value defined in [6.10.28 ROC CONFIG](#) (Address 3Eh). The ROC calculations are not affected.

The Limit registers ([6.10.32 R LIMH](#) and [6.10.33 R LIML](#)) and Results registers ([6.10.30 R RESH](#) and [6.10.31 R2/3 RESL](#)) are signed, two's-complement numbers stored in two consecutive registers.

If the Rate of Change result stored in registers 40h and 44h exceeds the programmed limit, the appropriate STATUS register bits will be set in [6.10.29 ROC STATUS](#) (Address 3Fh). The  $\overline{\text{ALERT}}$  pin may be asserted or masked, as set by [6.10.28 ROC CONFIG](#) (Address 3Eh). The MASK bit does not prevent the Status bits from updating, but if set, it prevents the  $\overline{\text{ALERT}}$  pin from asserting.

In addition to the functions described above, two additional temperature values are stored in register for retrieval. The maximum temperature for a given sample period is stored in a register (4Ah) that updates every sample period and in a second register (4Dh, 4Fh) that stores a "global value" and cleared only when read. The purpose of this register is to determine a maximum or minimum temperature, independent of the sample period.

Below is an example of setting up the Rate of Change feature and interpreting the results.

1. Enable Standby mode: Write a value of 40h into register 03h.
2. Set ROC gain: Write a value of 09h in register 3Dh. This sets the gain value of two for both Ext1 and Ext2/3.
3. Set ROC samples Ext1, Ext2/3: Write a value of 02h/02h in registers 43h/48h. This sets the ROC samples to five for both EXT1 and Ext2/3.
4. Set ROC Alert Limit Ext1/Ext2: Write a value of 01h/01h in registers 41h/46h. This sets the ROC limit to two for both Ext1 and Ext2/3.
5. Enable ROC and Hysteresis: Write a value of 20h in register 3Eh. This enables the ROC and sets the hysteresis value to zero.

ROC example:

1. Stabilize ambient temperature of device to +25°C.
2. Initiate One-Shot conversion: Write a value of FFh in register 0Fh.

# Multi-Channel Low-Voltage Remote Di... System Block Diagram

3. Read ROC Status register: For the first conversion, the ROC Status register (3Fh) reads 00h. Note that the initial slope of the sample period is determined using the first and second samples of the sample period.
4. Stabilize ambient temperature of device to +35°C.
5. Initiate One-Shot conversion: Write a value of FFh in register 0Fh.
6. Read ROC Status register: For the second conversion the ROC Status register (3Fh) should read 00h. Again, the initial slope of the sample period is determined using the first and second samples of the sample period.
7. Stabilize ambient temperature of device to 30°C.
8. Initiate One-Shot conversion: Write a value of FFh in register 0Fh.
9. Read ROC Status register: For the third conversion, the ROC Status register (3Fh) reads F0h. The initial slope of the sample period is positive, going from +25°C to +35°C. A change in temperature from 35°C to 30°C causes a slope change, the number of slope changes is now 1 (odd). See ROC Status register (3Fh) bit descriptions for more clarification.
10. Stabilize ambient temperature of device to 45°C.
11. Initiate One-Shot conversion: Write a value of FFh in register 0Fh.
12. Read ROC Status register: For the fourth conversion the ROC Status register (3Fh) should read C0h. The previous slope was negative, going from +35°C to +30°C. A change in temperature from +30°C to +45°C causes a slope change, the number of slope changes is now two (even).
13. Stabilize ambient temperature of device to +35°C.
14. Initiate One-Shot conversion: Write a value of FFh in register 0Fh.
15. Read ROC Status register: For the fifth conversion the ROC Status register (3Fh) should read FCh. The previous slope was positive, going from +30°C to +45°C. A change in temperature from +45°C to +35°C causes a slope change, the number of slope changes is now three (odd). Once the final conversion of the sample period is completed, the ROC result is calculated using the equation below and compared to the ROC HB/LB Limit registers. In this scenario, the ROC limit was exceeded and the appropriate bits were set in the ROC Status register.
16. Read ROC Result HB/LB ROC Result register: Once the final conversion of the sample period is completed, the ROC result is calculated using the following equation. This value is loaded into the ROC HB/LB result register. Based on the equation, the result is 5:

$$\text{ROC Results} = \frac{(35 - 25) \times 2}{4} = 5:$$

The ROCx high byte and low byte are in 9-bit signed two's complement format. The MSB of the low byte is the LSB of the corresponding high byte. For this example the ROC HB and LB would be as follows:

**Table 5-10. ROC1,2/3 High-Byte (40h, 44h)**

Sign	7	6	5	4	3	2	1
0	0	0	0	0	0	1	0

**Table 5-11. ROC Low-Byte (45h)**

LSB	2	1	0	LSB	3	2	1
HB2	—	—	—	HB1	—	—	—
1	0	0	0	1	0 (Note)	0 (Note)	0 (Note)

# Multi-Channel Low-Voltage Remote Di...

## System Block Diagram

.....continued

LSB	2	1	0	LSB	3	2	1
-----	---	---	---	-----	---	---	---

**Note:** Fractional value.

17. Read Global Max register (4Dh): The Global Max value is 2Dh or 45°C. The Global Max register contains a history of the highest temperature value. This value is reset only at POR and it is updated at the end of each ROC sample period.
18. Read Sample Period Max Register (49h): The Sample Period Max value should be 2Dh or 45°C. This register contains the highest temperature value for a given sample period and is updated after each temperature conversion.

## 6. System Management Bus Protocol

The EMC1812/13/14/15/33 devices communicate with a host controller through the SMBus/I<sup>2</sup>C. The SMBus/I<sup>2</sup>C is a two-wire serial communication protocol between a computer host and its peripheral devices. A detailed timing diagram is shown in [Figure 1-1](#). Stretching of the SMCLK signal is supported; however, the EMC1812/13/14/15/33 devices do not stretch the clock signal.

### 6.1 SMBus Start Bit

The SMBus Start bit is defined as a transition of the SMBus/I<sup>2</sup>C data line from a logic '1' state to a logic '0' state while the SMBus/I<sup>2</sup>C clock line is in a logic '1' state.

### 6.2 SMBus Address and RD/ $\overline{\text{WR}}$ Bit

The SMBus address byte consists of the 7-bit client address followed by the RD/ $\overline{\text{WR}}$  indicator bit. If this RD/ $\overline{\text{WR}}$  bit is a logic '0', the SMBus host is writing data to the client device. If this RD/ $\overline{\text{WR}}$  bit is a logic '1', the SMBus Host is reading data from the client device.

The response to the slave address 1001\_100xb for -1 parts and 1001\_101xb for -2 parts.

### 6.3 SMBus ACK and NACK Bits

The SMBus client acknowledges all data bytes that it receives. This is done by the client device pulling the SMBus Data line low after the 8<sup>th</sup> bit of each byte that is transmitted. This applies to both the Write Byte and Block Write protocols.

The Host will NACK (not acknowledge) the last data byte to be received from the client by holding the SMBus data line high after the 8<sup>th</sup> data bit has been sent. For the Block Read protocol, the Host will ACK (acknowledge) each data byte that it receives, except the last data byte.

#### 6.3.1 SMBus Data Bytes

All SMBus data bytes are sent Most Significant bit first and are composed of 8 bits of information.

### 6.4 SMBus Stop Bit

The SMBus Stop bit is defined as a transition of the SMBus Data line from a logic '0' state to a logic '1' state while the SMBus clock line is in a logic '1' state. When a EMC1812/13/14/15/33 device detects an SMBus Stop bit and it has been communicating with the SMBus protocol, it will reset its client interface and prepare to receive further communications.

### 6.5 SMBus Time-Out

The EMC1812/13/14/15/33 device family includes an SMBus time-out feature. Following a 30 ms period of inactivity on the SMBus where the SMCLK pin is held low, the device will time-out and reset the SMBus interface.

The time-out function defaults to disabled. It can be enabled by setting the TIMEOUT bit in the Consecutive Alert register (see [Consecutive Alert Register \(address 22h\)](#)).

### 6.6 SMBus and I<sup>2</sup>C Compliance

The major differences between SMBus and I<sup>2</sup>C devices include the following:

- Minimum frequency for SMBus communications is 10 kHz
- The client protocol resets if the clock is held low for longer than 30 ms
- Except when operating in the Standby mode, the client protocol resets if both the clock and the data line are high for longer than 150  $\mu$ s (Idle condition)
- I<sup>2</sup>C devices do not support the Alert Response Address functionality (which is optional for SMBus)

For complete compliance information, refer to “**Application Note 14.0 - Microchip Dedicated Slave Devices in I<sup>2</sup>C™ Systems**” (DS00001853)

### 6.7 SMBus Protocols

The EMC1812/13/14/15/33 devices are SMBus 2.0 compatible and support send byte, read byte, block read, receive byte as valid protocols, as shown below. They also support the I<sup>2</sup>C Block Read and Block Write protocols. The device supports write byte, read byte and block read/block write.

All of the protocols below use the convention in the SMBus Protocol table.

**Table 6-1. SMBus Protocol**

Data Sent to Device	Data Sent to the Host
# of bits sent	# of bits sent

#### 6.7.1 SMBus Write Byte

The Write Byte is used to write one byte of data to a specific register, as shown in the following table.

**Table 6-2. SMBus Write Byte Protocol**

START	Slave Address	WR	ACK	Register Address	ACK	Register Data	ACK	STOP
1 → 0	YYYY_YYY	0	0	XXh	0	XXh	0	0 → 1

#### 6.7.2 Block Write

The Block Write is used to write multiple data bytes to a group of contiguous registers, as shown below. It is an extension of the Write Byte protocol.

**Table 6-3. Block Write Protocol**

START	Slave Address	WR	ACK	Register Address	ACK	Repeat N Times		STOP
						Register Data	ACK	
1 → 0	YYYY_YYY	0	0	XXh	0	XXh	0	0 → 1

**Note:** When using the Block Write protocol, the internal Address Pointer will be automatically incremented after every data byte is received. It will wrap from FFh to 00h.

**Note:** The Block Write and Block Read protocols require that the Address Pointer be automatically incremented. For a write command, the Address Pointer will be automatically incremented when the ACK is sent to the host. There is no over or under bound limit checking and the Address Pointer will wrap around from FFh to 00h if necessary.



# Multi-Channel Low-Voltage Remote Di...

## System Management Bus Protocol

### 6.7.3 SMBus Read Byte

The Read Byte protocol is used to read one byte of data from the registers, as shown below.

**Table 6-4. Read Byte Protocol**

START	Slave Address	WRITE	ACK	Register Data	ACK
1 → 0	YYYY_YYY	0	0	XXh	0

START	Slave Address	READ	ACK	Register Data	NACK	STOP
1 → 0	0101_000	1	0	XXh	1	0 → 1

### 6.7.4 Block Read

The Block Read is used to read multiple data bytes from a group of contiguous registers, as shown below. It is an extension of the Read Byte protocol.

**Note:** When using the Block Read protocol, the internal Address Pointer will be automatically incremented after every data byte is received. It will wrap from FFh to 00h.

**Table 6-5. Block Read Protocol**

START	Slave Address	Write	ACK	Register Address	ACK
1->0	YYYY_YYY	0	0	XXh	0

START	Slave Address	Read	ACK	Register Data	ACK	Register Data	NACK	STOP
1 → 0	YYYY_YYY	1	0	XXh	0	XXh	1	0 → 1

**Note:** The Block Write and Block Read protocols require that the Address Pointer be automatically incremented. For a read command, the Address Pointer will be automatically incremented when the ACK is sent by the host. There is no over or under bound limit checking and the Address Pointer will wrap around from FFh to 00h if necessary.

### 6.7.5 SMBus Send Byte

The Send Byte protocol is used to set the internal Address Register Pointer to the correct address location. No data is transferred during the Send Byte protocol, as shown below.

**Table 6-6. Send Byte Protocol**

START	Slave Address	WR	ACK	Register Data	ACK	STOP
1 → 0	YYYY_YYY	0	0	XXh	0	0 → 1

### 6.7.6 SMBus Receive Byte

The Receive Byte protocol is used to read data from a register when the internal register Address Pointer is known to be at the right location (e.g., set via Send Byte). This is used for consecutive reads of the same register as shown in [Table 6-7](#).

**Table 6-7. Receive Byte Protocol**

START	Slave Address	RD	ACK	Register Data	NACK	STOP
1 → 0	YYYY_YYY	1	0	XXh	1	0 → 1

### 6.8 THERM Pin Considerations

Because of the decode method used to determine the I<sup>2</sup>C address, it is important that the pull-up resistance on the THERM pin be within the tolerances shown in [Table 5-2](#).

For  $t_{INT\_T}$  after power-up, the THERM pin must not be pulled low or the I<sup>2</sup>C address will not be decoded properly. If the system requirements do not permit these conditions, the THERM pin must be isolated from its hard-wired OR'd bus during this time.

One method of isolating this pin is shown in the following figure.

**Figure 6-1. THERM Pin Isolation**



# Multi-Channel Low-Voltage Remote Di...

## System Management Bus Protocol

### 6.9 Register Summary

Reserved bitfields are marked gray. Reserved bitfield will read as '0'.

Offset	Name	Bit Pos.									
0x00	INT HIGH BYTE	7:0	IHB[7:0]								
0x01	EXT1 HIGH BYTE	7:0	EXT(N)HB[7:0]								
0x02	STATUS	7:0	ROCF	HOTCHG	BUSY	HIGH	LOW	FAULT	ETHRM	ITHRM	
0x03	CONFIG	7:0	MSKAL	R/S	AT/THM	RECD1/2	RECD3/4	RANGE	DA_ENA	APDD	
0x04	CONVERT	7:0	CONV[3:0]								
0x05	INT DIODE HIGH LIMIT	7:0	IDHL[7:0]								
0x06	INT DIODE LOW LIMIT	7:0	IDLL[7:0]								
0x07	EXT1 HIGH LIMIT HIGH BYTE	7:0	EXT(N)HLHB[7:0]								
0x08	EXT1 LOW LIMIT HIGH BYTE	7:0	EXT(N)LLHB[7:0]								
0x09	CONFIG	7:0	MSKAL	R/S	AT/THM	RECD1/2	RECD3/4	RANGE	DA_ENA	APDD	
0x0A	CONVERT	7:0	CONV[3:0]								
0x0B	INT DIODE HIGH LIMIT	7:0	IDHL[7:0]								
0x0C	INT DIODE LOW LIMIT	7:0	IDLL[7:0]								
0x0D	EXT1 HIGH LIMIT HIGH BYTE	7:0	EXT(N)HLHB[7:0]								
0x0E	EXT1 LOW LIMIT HIGH BYTE	7:0	EXT(N)LLHB[7:0]								
0x0F	ONE SHOT	7:0	ONSH[7:0]								
0x10	EXT1 LOW BYTE	7:0	EXT(N)LB[2:0]								
0x11	SCRTCHPD1	7:0	SPD(N)[7:0]								
0x12	SCRTCHPD2	7:0	SPD(N)[7:0]								
0x13	EXT1 HIGH LIMIT LOW BYTE	7:0	EXT(N)HLLB[2:0]								
0x14	EXT1 LOW LIMIT LOW BYTE	7:0	EXT(N)LLLB[2:0]								
0x15	EXT2 HIGH LIMIT HIGH BYTE	7:0	EXT(N)HLHB[7:0]								
0x16	EXT2 LOW LIMIT HIGH BYTE	7:0	EXT(N)LLHB[7:0]								
0x17	EXT2 HIGH LIMIT LOW BYTE	7:0	EXT(N)HLLB[2:0]								
0x18	EXT2 LOW LIMIT LOW BYTE	7:0	EXT(N)LLLB[2:0]								
0x19	EXT1 THERM LIMIT	7:0	EXT(N)THL[7:0]								
0x1A	EXT2 THERM LIMIT	7:0	EXT(N)THL[7:0]								
0x1B	EXTERNAL DIODE FAULT STATUS	7:0				E4FLT	E3FLT	E2FLT	E1FLT		

# Multi-Channel Low-Voltage Remote Di...

## System Management Bus Protocol

.....continued

Offset	Name	Bit Pos.									
0x1C ... 0x1E	Reserved										
0x1F	DIODE FAULT MASK	7:0				E4MASK	E3MASK	E2MASK	E1MASK	INTMASK	
0x20	INT DIODE THERM LIMIT	7:0	IDTHL[7:0]								
0x21	THRM HYS	7:0	THRMH[7:0]								
0x22	CONSEC ALERT	7:0	TMOUT	CTHRM[2:0]				CALRT[2:0]			
0x23	EXT2 HIGH BYTE	7:0	EXT(N)HB[7:0]								
0x24	EXT2 LOW BYTE	7:0	EXT(N)LB[2:0]								
0x25	EXT1 BETA CONFIG	7:0				ENBL(N)	BETA(N)[3:0]				
0x26	EXT2 BETA CONFIG	7:0				ENBL(N)	BETA(N)[3:0]				
0x27	EXT1 IDEALITY FACTOR	7:0			IDEAL(N)[5:0]						
0x28	EXT2 IDEALITY FACTOR	7:0			IDEAL(N)[5:0]						
0x29	INT LOW BYTE	7:0	ILB[2:0]								
0x2A	EXT3 HIGH BYTE	7:0	EXT(N)HB[7:0]								
0x2B	EXT3 LOW BYTE	7:0	EXT(N)LB[2:0]								
0x2C	EXT3 HIGH LIMIT HIGH BYTE	7:0	EXT(N)HLHB[7:0]								
0x2D	EXT3 LOW LIMIT HIGH BYTE	7:0	EXT(N)LLHB[7:0]								
0x2E	EXT3 HIGH LIMIT LOW BYTE	7:0	EXT(N)HLLB[2:0]								
0x2F	EXT3 LOW LIMIT LOW BYTE	7:0	EXT(N)LLL[2:0]								
0x30	EXT3 THERM LIMIT	7:0	EXT(N)THL[7:0]								
0x31	EXT3 IDEALITY FACTOR	7:0			IDEAL(N)[5:0]						
0x32	EXT4 HIGH BYTE	7:0	EXT(N)HB[7:0]								
0x33	EXT4 LOW BYTE	7:0	EXT(N)LB[2:0]								
0x34	EXT4 HIGH LIMIT HIGH BYTE	7:0	EXT(N)HLHB[7:0]								
0x35	EXT4 LOW LIMIT HIGH BYTE	7:0	EXT(N)LLHB[7:0]								
0x36	EXT4 HIGH LIMIT LOW BYTE	7:0	EXT(N)HLLB[2:0]								
0x37	EXT4 LOW LIMIT LOW BYTE	7:0	EXT(N)LLL[2:0]								
0x38	EXT4 THERM LIMIT	7:0	EXT(N)THL[7:0]								
0x39	EXT4 IDEALITY FACTOR	7:0			IDEAL(N)[5:0]						

# Multi-Channel Low-Voltage Remote Di... System Management Bus Protocol

.....continued

Offset	Name	Bit Pos.									
0x3A	HIGH LIMIT STATUS	7:0				E4HIGH	E3HIGH	E2HIGH	E1HIGH	IHIGH	
0x3B	LOW LIMIT STATUS	7:0				E4LOW	E3LOW	E2LOW	E1LOW	ILOW	
0x3C	THERM LIMIT STATUS	7:0				E4THERM	E3THERM	E2THERM	E1THERM	ITHERM	
0x3D	ROC GAIN	7:0	RC1G[7:0]								
0x3E	ROC CONFIG	7:0			EN_ROC	MASK2/3	MASK1	RCHY[2:0]			
0x3F	ROC STATUS	7:0	SLCG2/3	SLCG1	R2/3ODD	R1ODD	RC2/3HI	RC1HI	RC2/3LO	RC1LO	
0x40	R1 RESH	7:0	R(N)RH[7:0]								
0x41	R1 LIMH	7:0	R(N)LIMH[7:0]								
0x42	R1 LIML	7:0	R(N)LIML[3:0]								
0x43	R1 SMPL	7:0					R(N)SH[3:0]				
0x44	R2 RESH	7:0	R(N)RH[7:0]								
0x45	R2/3 RESL	7:0	R2/3_RL[3:0]				R1_RL[3:0]				
0x46	R2 LIMH	7:0	R(N)LIMH[7:0]								
0x47	R2 LIML	7:0	R(N)LIML[3:0]								
0x48	R2 SMPL	7:0					R(N)SH[3:0]				
0x49	PER MAXTH	7:0	GM(N)HB[7:0]								
0x4A	PER MAXT1L	7:0	PM(N)L[2:0]								
0x4B	PER MAXTH	7:0	GM(N)HB[7:0]								
0x4C	PER MAXT2/3L	7:0	PM(N)L[2:0]								
0x4D	GBL MAXT1H	7:0	GM(N)HB[7:0]								
0x4E	GBL MAXT1L	7:0	GM(N)LB[2:0]								
0x4F	GBL MAXT2H	7:0	GM(N)HB[7:0]								
0x50	GBL MAXT2L	7:0	GM(N)LB[2:0]								
0x51	FILTER SEL	7:0							FILTER[1:0]		
0x52	Reserved										
...											
0x5F											
0x60	INT HIGH BYTE	7:0	IHB[7:0]								
0x61	INT LOW BYTE	7:0	ILB[2:0]								
0x62	EXT1 HIGH BYTE	7:0	EXT(N)HB[7:0]								
0x63	EXT1 LOW BYTE	7:0	EXT(N)LB[2:0]								
0x64	EXT2 HIGH BYTE	7:0	EXT(N)HB[7:0]								
0x65	EXT2 LOW BYTE	7:0	EXT(N)LB[2:0]								
0x66	EXT3 HIGH BYTE	7:0	EXT(N)HB[7:0]								
0x67	EXT3 LOW BYTE	7:0	EXT(N)LB[2:0]								
0x68	EXT4 HIGH BYTE	7:0	EXT(N)HB[7:0]								
0x69	EXT4 LOW BYTE	7:0	EXT(N)LB[2:0]								
0x6A	HOTTEST DIODE HIGH BYTE	7:0	HDHB[7:0]								
0x6B	HOTTEST DIODE LOW BYTE	7:0	HDLB[2:0]								
0x6C	HOTTEST STATUS	7:0				E4HOT	E3HOT	E2HOT	E1HOT	IHOT	
0x6D	HOTTEST CONFIG	7:0			REMHOT	E4ENB	E3ENB	E2ENB	E1ENB	IENB	

# Multi-Channel Low-Voltage Remote Di...

## System Management Bus Protocol

.....continued

Offset	Name	Bit Pos.								
0x6E ... 0xFC	Reserved									
0xFD	PRODUCT ID	7:0	PRODUCT_ID[7:0]							
0xFE	MANUFACTURER ID	7:0	MCHP_ID[7:0]							
0xFF	REVISION	7:0	REV[7:0]							

### 6.10 Data Read Interlock

When any temperature channel high byte register is read, the corresponding low byte is copied into an internal 'shadow' register. The user is free to read the low byte at any time and be ensured that it corresponds to the previously read high byte. Regardless if the low byte is read or not, reading from the same high byte register again automatically refreshes this stored low byte data.

# Multi-Channel Low-Voltage Remote Di...

## System Management Bus Protocol

### 6.10.1 Internal Diode High Byte Data Register (Addresses 00h, 60h)

**Name:** INT HIGH BYTE  
**Offset:** 0x00, 0x60

Bit	7	6	5	4	3	2	1	0
	IHB[7:0]							
Access	RO	RO	RO	RO	RO	RO	RO	RO
Reset	0	0	0	0	0	0	0	0

**Bits 7:0 – IHB[7:0]** Unsigned or unsigned offset depending on the RANGE bit.

# Multi-Channel Low-Voltage Remote Di...

## System Management Bus Protocol

### 6.10.2 Internal Diode Low Byte Data Register (Addresses 29h, 61h)

**Name:** INT LOW BYTE  
**Offset:** 0x29, 0x61

Bit	7	6	5	4	3	2	1	0
	ILB[2:0]							
Access	RW	RW	RW					
Reset	0	0	0					

**Bits 7:5 – ILB[2:0]** Fractional portion of the Internal Diode Temperature to be added to the value at register 00h.

Value	Description
111	0.875 °C
110	0.750 °C
101	0.625 °C
100	0.500 °C
011	0.375 °C
010	0.250 °C
001	0.125 °C
000	0.000 °C



# Multi-Channel Low-Voltage Remote Di... System Management Bus Protocol

## 6.10.3 External Diode High Byte Data Register (Addresses 01h, 23h, 2Ah, 32h, 62h, 64h, 66h and 68h)

**Name:** EXT<sub>n</sub> HIGH BYTE

**Offset:** 0x01, 0x23, 0x2A, 0x32, 0x62, 0x64, 0x66, 0x68

Bit	7	6	5	4	3	2	1	0
	EXT(N)HB[7:0]							
Access	RO	RO	RO	RO	RO	RO	RO	RO
Reset	0	0	0	0	0	0	0	0

**Bits 7:0 – EXT(N)HB[7:0]** Unsigned or unsigned offset depending on the RANGE bit.

# Multi-Channel Low-Voltage Remote Di...

## System Management Bus Protocol

### 6.10.4 External Diode Low Byte Data Register (Addresses 10h, 24h, 2Bh, 33h, 63h, 65h, 67h and 69h)

**Name:** EXT<sub>n</sub> LOW BYTE  
**Offset:** 0x10, 0x24, 0x2B, 0x33, 0x63, 0x65, 0x67, 0x69

Bit	7	6	5	4	3	2	1	0
	EXT(N)LB[2:0]							
Access	RO	RO	RO					
Reset	0	0	0					

**Bits 7:5 – EXT(N)LB[2:0]** Fractional portion of the internal diode temperature to be added to the value at register 00h

Value	Description
111	0.875 °C
110	0.750 °C
101	0.625 °C
100	0.500 °C
011	0.375 °C
010	0.250 °C
001	0.125 °C
000	0.000 °C

# Multi-Channel Low-Voltage Remote Di... System Management Bus Protocol

## 6.10.5 Diode Status Register (Address 02h)

**Name:** STATUS  
**Offset:** 0x02

The STATUS register reports the operating status of the internal diode and external diode channels.

Bit	7	6	5	4	3	2	1	0
	ROCF	HOTCHG	BUSY	HIGH	LOW	FAULT	ETHRM	ITHRM
Access	RO	RO	RO	RO	RO	RO	RO	RO
Reset	0	0	0	0	0	0	0	0

**Bit 7 – ROCF** This bit indicates if external diode 1 or 2 has exceeded the programmed Rate of Change limit.

Value	Description
1	ROC above limit
0	ROC not above limit

**Bit 6 – HOTCHG** This bit indicates if the hottest channel has changed from the previous temperature measurement.

Value	Description
1	The hottest channel has changed from the previous temperature measurement
0	The hottest channel has not changed from the previous temperature measurement

**Bit 5 – BUSY** This bit indicates if the ADC is currently converted measured data.

Value	Description
1	The ADC is currently converting measured data
0	The ADC is not currently converting measured data

**Bit 4 – HIGH** This bit indicates if a temperature channel exceeds its programmed high limit. When set, this bit will assert the  $\overline{\text{ALERT}}$  pin.

Value	Description
1	Reported temperature above the high limit
0	Reported temperature is not above the high limit

**Bit 3 – LOW** This bit indicates if a temperature channel drops below its programmed low limit. When set, this bit will assert the  $\overline{\text{ALERT}}$  pin.

Value	Description
1	Reported temperature below, or equal to, the low limit
0	Reported temperature is not below the low limit

**Bit 2 – FAULT** This bit indicates when a Diode Fault is detected. When set, this bit will assert the  $\overline{\text{ALERT}}$  pin.

Value	Description
1	A diode fault has been detected

# Multi-Channel Low-Voltage Remote Di...

## System Management Bus Protocol

---

---

Value	Description
0	No Fault reported

**Bit 1 – ETHRM** This bit indicates the external diode channel exceeds the programmed Therm limit. When set, this bit will assert the  $\overline{\text{THERM}}$  pin. This bit will remain set until the  $\overline{\text{THERM}}$  pin is released, at which point it will be automatically cleared.

Value	Description
1	Reported temperature above the high limit
0	Reported temperature is not above the high limit

**Bit 0 – ITHRM** This bit is set when the internal diode channel exceeds the programmed Therm limit. When set, this bit will assert the  $\overline{\text{THERM}}$  pin. This bit will remain set until the  $\overline{\text{THERM}}$  pin is released, at which point it will be automatically cleared.

Value	Description
1	Reported temperature above the high limit
0	Reported temperature is not above the high limit

# Multi-Channel Low-Voltage Remote Di...

## System Management Bus Protocol

### 6.10.6 Configuration Register (Addresses 03h and 09h)

**Name:** CONFIG  
**Offset:** 0x03, 0x09

Bit	7	6	5	4	3	2	1	0
	MSKAL	R/S	AT/THM	RECD1/2	RECD3/4	RANGE	DA_ENA	APDD
Access	RW	RW	RW	RW	RW	RW	RW	RW
Reset	0	0	0	0	0	0	0	0

**Bit 7 – MSKAL** Masks the ALERT pin from asserting when the ALERT pin is in Interrupt mode. This bit has no effect when the ALERT pin is in Comparator mode.

Value	Description
1	The ALERT pin is masked and will not be asserted for any interrupt condition when the ALERT pin is in Interrupt mode. The Status Registers will be updated normally.
0	The ALERT pin is not masked. If any of the appropriate Status bits are set, the ALERT pin will be asserted.

**Bit 6 – R/S** Controls Run/Stop states.

Value	Description
1	The device is in Stop (standby) state and not converting (unless a one-shot has been commanded)
0	The device is in Run (active) state and converting on all channels

**Bit 5 – AT/THM** Controls the operation of the ALERT pin. When the ALERT pin is in Comparator mode, each channel has a consecutive counter OR'ed to assert the ALERT pin. The ALERT pin is deasserted after one measurement is below the high limit minus the Therm Hysteresis.

Value	Description
1	The ALERT pin acts in Comparator mode as described in <a href="#">5.5.2 ALERT/THERM2 Pin in Therm Mode</a> . In this mode the MASK_ALL bit is ignored.
0	The ALERT pin acts in Interrupt mode as described in <a href="#">5.5.1 ALERT/THERM2 Pin Interrupt Mode</a>

**Bit 4 – RECD1/2** Disables the Resistance Error Correction (REC) for the DP1/DN1 pins.

Value	Description
1	REC is disabled for the DP1/DN1 and DP2/DN2 pins
0	REC is enabled for the DP1/DN1 and DP2/DN2 pins

**Bit 3 – RECD3/4** Disables the Resistance Error Correction (REC) for the DP2/DN2 pins.

Value	Description
1	REC is disabled for the DP2/DN2 and DP4/DN4 pins
0	REC is enabled for the DP2/DN2 and DP4/DN4 pins

**Bit 2 – RANGE** Configures the measurement range and data format of the temperature channels.

# Multi-Channel Low-Voltage Remote Di...

## System Management Bus Protocol

Value	Description
1	The temperature measurement range is -64°C to +191.875°C and the data format is offset binary (see <a href="#">Table 5-1</a> )
0	The temperature measurement range is 0°C to +127.875°C and the data format is binary

**Bit 1 – DA\_ENA** Enables the dynamic averaging feature on all temperature channels.

Value	Description
1	The dynamic averaging feature is enabled. All temperature channels will be converted with an averaging factor that is based on the conversion rate, as shown in <a href="#">Table 5-3</a> .
0	The dynamic averaging feature is disabled. All temperature channels will be converted with a maximum averaging factor of 1x (equivalent to 11-bit conversion). For higher conversion rates, this averaging factor will be reduced, as shown in <a href="#">Table 5-4</a>

**Bit 0 – APDD** Disables the anti-parallel diode operation only allowing each APD pin set to bias and measure one diode.

Value	Description
1	Anti-Parallel Diode mode is disabled. Only one external diode will be measured on the DP1/DN1 and DP2/DN2 pins
0	Anti-Parallel Diode mode is enabled. Two external diodes will be measured on the DP1/DN1 and DP2/DN2 pins

# Multi-Channel Low-Voltage Remote Di...

## System Management Bus Protocol

### 6.10.7 Temperature Conversion Rate Register (Addresses 04h and 0Ah)

**Name:** CONVERT  
**Offset:** 0x04, 0x0A

Bit	7	6	5	4	3	2	1	0
					CONV[3:0]			
Access					RW	RW	RW	RW
Reset					0	0	0	0

**Bits 3:0 – CONV[3:0]** The Conversion Rate register controls how often the temperature measurement channels are updated and compared against the limits.

This register is fully accessible at either address. It determines the conversion rate as shown in [Table 5-3](#).

# Multi-Channel Low-Voltage Remote Di...

## System Management Bus Protocol

### 6.10.8 Internal Diode High Limit Register (Addresses 05h and 0Bh)

**Name:** INT DIODE HIGH LIMIT  
**Offset:** 0x05, 0x0B

Bit	7	6	5	4	3	2	1	0
	IDHL[7:0]							
Access	RW	RW	RW	RW	RW	RW	RW	RW
Reset	0	0	0	0	0	0	0	0

**Bits 7:0 – IDHL[7:0]** Unsigned or unsigned offset depending on the RANGE bit.



# Multi-Channel Low-Voltage Remote Di... System Management Bus Protocol

## 6.10.9 Internal Diode Low Limit Register (Addresses 06H and 0CH)

**Name:** INT DIODE LOW LIMIT  
**Offset:** 0x06, 0x0C

Bit	7	6	5	4	3	2	1	0
	IDLL[7:0]							
Access	RW	RW	RW	RW	RW	RW	RW	RW
Reset	0	0	0	0	0	0	0	0

**Bits 7:0 – IDLL[7:0]** Integer value of the Internal Diode temperature reading.

# Multi-Channel Low-Voltage Remote Di... System Management Bus Protocol

## 6.10.10 Ext High Limit High Byte Register (Addresses 07h, 0Dh, 15h, 2Ch and 34h)

**Name:** EXT HIGH LIMIT HIGH BYTE  
**Offset:** 0x07, 0x0D, 0x15, 0x2C, 0x34

Bit	7	6	5	4	3	2	1	0
	EXT(N)HLHB[7:0]							
Access	RW	RW	RW	RW	RW	RW	RW	RW
Reset	0	0	0	0	0	0	0	0

**Bits 7:0 – EXT(N)HLHB[7:0]** Integer value of the External Diode n temperature reading, where n = 1 to 4, depending on device.

# Multi-Channel Low-Voltage Remote Di...

## System Management Bus Protocol

### 6.10.11 Ext High Limit Low Byte Register (Addresses 13h, 17h, 2Eh and 36h)

**Name:** EXT HIGH LIMIT LOW BYTE  
**Offset:** 0x13, 0x17, 0x2E, 0x36

Bit	7	6	5	4	3	2	1	0
	EXT(N)HLLB[2:0]							
Access	RW	RW	RW					
Reset	0	0	0					

**Bits 7:5 – EXT(N)HLLB[2:0]** Fractional portion of the High Limit Temperature to be added to the value at the respective high byte registers.

Value	Description
111	0.875 °C
110	0.750 °C
101	0.625 °C
100	0.500 °C
011	0.375 °C
010	0.250 °C
001	0.125 °C
000	0.000 °C

# Multi-Channel Low-Voltage Remote Di...

## System Management Bus Protocol

### 6.10.12 Ext(n) Low Limit High Byte Register (Addresses 08h, 0Eh, 16h, 2Dh and 35h)

**Name:** EXT LOW LIMIT HIGH BYTE  
**Offset:** 0x08, 0x0E, 0x16, 0x2D, 0x35

Bit	7	6	5	4	3	2	1	0
	EXT(N)LLHB[7:0]							
Access	RW	RW	RW	RW	RW	RW	RW	RW
Reset	0	0	0	0	0	0	0	0

**Bits 7:0 – EXT(N)LLHB[7:0]** Integer portion of External Diode n Low Temperature Limit, where n = 1 to 4, depending on device.

# Multi-Channel Low-Voltage Remote Di...

## System Management Bus Protocol

### 6.10.13 Ext(n) Low Limit Low Byte Register (Addresses 14h, 18h, 2fh and 37h)

**Name:** EXT LOW LIMIT LOW BYTE  
**Offset:** 0x14, 0x18, 0x2f, 0x37

	7	6	5	4	3	2	1	0
	EXT(N)LLL[2:0]							
Access	RW	RW	RW					
Reset	0	0	0					

**Bits 7:5 – EXT(N)LLL[2:0]** Fractional portion of the Low Limit Temperature to be added to the value at the respective high byte registers, where n = 1 to 4.

Value	Description
111	0.875 °C
110	0.750 °C
101	0.625 °C
100	0.500 °C
011	0.375 °C
010	0.250 °C
001	0.125 °C
000	0.000 °C

# Multi-Channel Low-Voltage Remote Di...

## System Management Bus Protocol

### 6.10.14 Scratchpad Register (Addresses 11H and 12H)

**Name:** SCRTCHPD  
**Offset:** 0x11 + n\*0x01 [n=0..1]

Bit	7	6	5	4	3	2	1	0
	SPD(N)[7:0]							
Access	RW	RW	RW	RW	RW	RW	RW	RW
Reset	0	0	0	0	0	0	0	0

**Bits 7:0 – SPD(N)[7:0]** User temporary storage registers, where n = 1 to 2.

# Multi-Channel Low-Voltage Remote Di...

## System Management Bus Protocol

### 6.10.15 One-Shot Register (Address 0FH)

**Name:** ONE SHOT  
**Offset:** 0x0F

Bit	7	6	5	4	3	2	1	0
	ONSH[7:0]							
Access	RW	RW	RW	RW	RW	RW	RW	RW
Reset	0	0	0	0	0	0	0	0

**Bits 7:0 – ONSH[7:0]** When the device is in the Standby state, writing to the One-Shot register will initiate a conversion cycle and update the temperature measurements.

Writing to the One-Shot register while the device is in the Active state or when the BUSY bit is set in the STATUS register (Address 02h) will have no effect.

# Multi-Channel Low-Voltage Remote Di...

## System Management Bus Protocol

### 6.10.16 Ext(n) Therm Limit Register (Addresses 19h, 1ah, 30h and 38h)

**Name:** EXT<sub>n</sub> THERM LIMIT  
**Offset:** 0x19, 0x1a, 0x30, 0x38

Bit	7	6	5	4	3	2	1	0
	EXT(N)THL[7:0]							
Access	RW	RW	RW	RW	RW	RW	RW	RW
Reset	0	0	0	0	0	0	0	0

**Bits 7:0 – EXT(N)THL[7:0]** External Diode n  $\overline{\text{THERM}}$  Limits, where n = 1 to 4.



# Multi-Channel Low-Voltage Remote Di... System Management Bus Protocol

## 6.10.17 Internal Diode Therm Limit Register (Address 20h)

**Name:** INT DIODE THERM LIMIT  
**Offset:** 0x20

Bit	7	6	5	4	3	2	1	0
	IDTHL[7:0]							
Access	RW	RW	RW	RW	RW	RW	RW	RW
Reset	0	0	0	0	0	0	0	0

**Bits 7:0 – IDTHL[7:0]** Internal Diode  $\overline{\text{THERM}}$  Limits.

# Multi-Channel Low-Voltage Remote Di...

## System Management Bus Protocol

### 6.10.18 Therm Limit Hysteresis Register (Address 21h)

**Name:** THRM HYS  
**Offset:** 0x21

Bit	7	6	5	4	3	2	1	0
	THRMH[7:0]							
Access	RW	RW	RW	RW	RW	RW	RW	RW
Reset	0	0	0	0	1	0	1	0

**Bits 7:0 – THRMH[7:0]** I THERM Limit hysteresis.

# Multi-Channel Low-Voltage Remote Di...

## System Management Bus Protocol

### 6.10.19 External Diode Fault Status Register (Address 1bh)

**Name:** EXTERNAL DIODE FAULT STATUS  
**Offset:** 0x1B

**Note:** The External Diode Fault register indicates which of the external diodes caused the FAULT bit in the STATUS register to be set. This register is cleared when it is read.

Bit	7	6	5	4	3	2	1	0
				E4FLT	E3FLT	E2FLT	E1FLT	
Access				RC	RC	RC	RC	
Reset				0	0	0	0	

**Bit 4 – E4FLT** This bit is set if the External Diode 4 channel reported a Diode Fault.

Value	Description
1	Diode Fault condition present
0	No Diode Fault present

**Bit 3 – E3FLT** This bit is set if the External Diode 3 channel reported a Diode Fault.

Value	Description
1	Diode Fault condition present
0	No Diode Fault present

**Bit 2 – E2FLT** This bit is set if the External Diode 2 channel reported a Diode Fault.

Value	Description
1	Diode Fault condition present
0	No Diode Fault present

**Bit 1 – E1FLT** This bit is set if the External Diode 1 channel reported a Diode Fault.

Value	Description
1	Diode Fault condition present
0	No Diode Fault present

# Multi-Channel Low-Voltage Remote Di... System Management Bus Protocol

## 6.10.20 Diode Fault Mask Register (Address 1Fh)

**Name:** DIODE FAULT MASK  
**Offset:** 0x1F

**Note:** The Channel Mask register controls individual channel masking. When a channel is masked, the  $\overline{\text{ALERT}}$  pin will not be asserted when the masked channel reads a Diode Fault or out-of-limit error. The channel mask does not mask the  $\overline{\text{THERM}}$  pin.

Bit	7	6	5	4	3	2	1	0
				E4MASK	E3MASK	E2MASK	E1MASK	INTMASK
Access				RW	RW	RW	RW	RW
Reset				0	0	0	0	0

**Bit 4 – E4MASK** Masks the  $\overline{\text{ALERT}}$  pin from asserting when the External Diode 4 channel is out-of-limit or reports a Diode Fault.

Value	Description
1	The External Diode 4 channel will not cause the $\overline{\text{ALERT}}$ pin to be asserted if it is out-of-limit or reports a Diode Fault
0	The External Diode 4 channel will cause the $\overline{\text{ALERT}}$ pin to be asserted if it is out-of-limit or reports a Diode Fault

**Bit 3 – E3MASK** Masks the  $\overline{\text{ALERT}}$  pin from asserting when the External Diode 3 channel is out-of-limit or reports a Diode Fault.

Value	Description
1	The External Diode 3 channel will not cause the $\overline{\text{ALERT}}$ pin to be asserted if it is out-of-limit or reports a Diode Fault
0	The External Diode 3 channel will cause the $\overline{\text{ALERT}}$ pin to be asserted if it is out-of-limit or reports a Diode Fault

**Bit 2 – E2MASK** Masks the  $\overline{\text{ALERT}}$  pin from asserting when the External Diode 2 channel is out-of-limit or reports a Diode Fault.

Value	Description
1	The External Diode 2 channel will not cause the $\overline{\text{ALERT}}$ pin to be asserted if it is out-of-limit or reports a Diode Fault
0	The External Diode 2 channel will cause the $\overline{\text{ALERT}}$ pin to be asserted if it is out-of-limit or reports a Diode Fault

**Bit 1 – E1MASK** Masks the  $\overline{\text{ALERT}}$  pin from asserting when the External Diode 1 channel is out-of-limit or reports a Diode Fault.

Value	Description
1	The External Diode 1 channel will not cause the $\overline{\text{ALERT}}$ pin to be asserted if it is out-of-limit or reports a Diode Fault
0	The External Diode 1 channel will cause the $\overline{\text{ALERT}}$ pin to be asserted if it is out-of-limit or reports a Diode Fault

# Multi-Channel Low-Voltage Remote Di...

## System Management Bus Protocol

---

---

**Bit 0 – INTMASK** Masks the ALERT pin from asserting when the Internal Diode temperature is out-of-limit.

Value	Description
1	The Internal Diode channel will not cause the $\overline{\text{ALERT}}$ pin to be asserted if it is out-of-limit
0	The Internal Diode channel will cause the $\overline{\text{ALERT}}$ pin to be asserted if it is out-of-limit

# Multi-Channel Low-Voltage Remote Di...

## System Management Bus Protocol

### 6.10.21 Consecutive Alert Register (Address 22h)

**Name:** CONSEC ALERT  
**Offset:** 0x22

Bit	7	6	5	4	3	2	1	0
	TMOUT	CTHRM[2:0]			CALRT[2:0]			
Access	RW	RW	RW	RW	RW	RW	RW	
Reset	0	1	1	1	0	0	0	

**Bit 7 – TMOUT** Enables the time-out and idle functionality of the I<sup>2</sup>C protocol.

Value	Description
1	The I <sup>2</sup> C time-out and idle functionality are enabled. The I <sup>2</sup> C interface will time-out if the clock line is held low for longer than 30 ms. Likewise, it will reset if both the data and clock lines are held high for longer than 200 μs.
0	The I <sup>2</sup> C time-out and idle functionality are disabled. The I <sup>2</sup> C interface will not time-out if the clock line is held low for longer than 30 ms. Likewise, it will not reset if both the data and clock lines are held high for longer than 200 μs. This is used for I <sup>2</sup> C compliance.

**Bits 6:4 – CTHRM[2:0]** Determines the number of consecutive measurements that must exceed the corresponding Therm Limit before the  $\overline{\text{THERM}}$  pin is asserted.

Value	Description
000	1
001	2
011	3
111	4

**Bits 3:1 – CALRT[2:0]** Determines the number of consecutive measurements that must exceed the corresponding Therm Limit before the  $\overline{\text{ALERT}}$  pin is asserted.

Value	Description
000	1
001	2
011	3
111	4

# Multi-Channel Low-Voltage Remote Di...

## System Management Bus Protocol

### 6.10.22 Ext(n) Beta Compensation Configuration Register (Address 25h and 26h)

**Name:** EXTn BETA CONFIG  
**Offset:** 0x25, 0x26

	Bit	7	6	5	4	3	2	1	0
					ENBL(N)	BETA(N)[3:0]			
Access					RW	RO	RO	RO	RO
Reset					0	0	0	0	0

**Bit 4 – ENBL(N)** Enables the Beta Compensation factor auto-detection function. X = 1 or 2, depending on the device.

Value	Description
1	Auto-Beta detection for External Diode x is enabled
0	Auto-Beta detection for External Diode x is disabled

**Bits 3:0 – BETA(N)[3:0]** These bits always reflect the current beta configuration settings. If auto-detection circuitry is enabled, these bits will be updated automatically and writing to these bits will have no effect. See [Table 5-6](#) for details.

# Multi-Channel Low-Voltage Remote Di...

## System Management Bus Protocol

### 6.10.23 Ext (n) Programmable Ideality Factor Register (Address 27h, 28h, 31h and 39h)

**Name:** EXT<sub>n</sub> IDEALITY FACTOR  
**Offset:** 0x27, 0x28, 0x31, 0x39

Bit	7	6	5	4	3	2	1	0
			IDEAL(N)[5:0]					
Access			RW	RW	RW	RW	RW	RW
Reset			0	1	0	0	1	0

**Bits 5:0 – IDEAL(N)[5:0]** External Diode n Ideality factor, where n = 1 to 4 depending on device.  
 See [Table 5-7](#) or [Table 5-8](#) for details.



# Multi-Channel Low-Voltage Remote Di...

## System Management Bus Protocol

### 6.10.24 High Limit Status Register (Address 3Ah)

**Name:** HIGH LIMIT STATUS  
**Offset:** 0x3A

	Bit	7	6	5	4	3	2	1	0
					E4HIGH	E3HIGH	E2HIGH	E1HIGH	IHIGH
Access					RC	RC	RC	RC	RC
Reset					0	0	0	0	0

#### Bit 4 – E4HIGH

This bit is set when the External Diode 4 exceeds its programmed high limit. Reading this register will also clear the HIGH bit.

Value	Description
1	High limit exceeded
0	High limit not exceeded

#### Bit 3 – E3HIGH

This bit is set when the External Diode 3 exceeds its programmed high limit. Reading this register will also clear the HIGH bit.

Value	Description
1	High limit exceeded
0	High limit not exceeded

**Bit 2 – E2HIGH** This bit is set when the External Diode 2 exceeds its programmed high limit. Reading this register will also clear the HIGH bit.

Value	Description
1	High limit exceeded
0	High limit not exceeded

**Bit 1 – E1HIGH** This bit is set when the External Diode 1 exceeds its programmed high limit. Reading this register will also clear the HIGH bit.

Value	Description
1	High limit exceeded
0	High limit not exceeded

**Bit 0 – IHIGH** This bit is set when the Internal Diode exceeds its programmed high limit. Reading this register will also clear the HIGH bit.

Value	Description
1	High limit exceeded
0	High limit not exceeded

# Multi-Channel Low-Voltage Remote Di...

## System Management Bus Protocol

### 6.10.25 Low Limit Status Register (Address 3Bh)

**Name:** LOW LIMIT STATUS  
**Offset:** 0x3B

	7	6	5	4	3	2	1	0
				E4LOW	E3LOW	E2LOW	E1LOW	ILOW
Access				RC	RC	RC	RC	RC
Reset				0	0	0	0	0

**Bit 4 – E4LOW** This bit is set when the External Diode 4 channel drops below its programmed low limit. Reading from the register will also clear the LOW Status bit in the STATUS register.

Value	Description
1	Low limit exceeded
0	Low limit not exceeded

**Bit 3 – E3LOW** This bit is set when the External Diode 3 channel drops below its programmed low limit. Reading from the register will also clear the LOW Status bit in the STATUS register.

Value	Description
1	Low limit exceeded
0	Low limit not exceeded

**Bit 2 – E2LOW** This bit is set when the External Diode 2 drops below its programmed low limit. Reading this register will also clear the LOW bit.

Value	Description
1	Low limit exceeded
0	Low limit not exceeded

**Bit 1 – E1LOW** This bit is set when the External Diode 1 drops below its programmed low limit. Reading this register will also clear the LOW bit.

Value	Description
1	Low limit exceeded
0	Low limit not exceeded

**Bit 0 – ILOW** This bit is set when the Internal Diode drops below its programmed low limit. Reading this register will also clear the LOW bit.

Value	Description
1	Low limit exceeded
0	Low limit not exceeded

### 6.10.26 Therm High Limit Status Register (Address 3Ch)

**Name:** THERM LIMIT STATUS  
**Offset:** 0x3C

**Note:** The Therm Limit Status register contains the Status bits that are set when a temperature channel Therm Limit is exceeded. If any of these bits are set, the  $\overline{\text{THERM}}$  Status bit in the STATUS register is set. Reading from the Therm Limit Status register will not clear the Status bits. Once the temperature drops below the Therm Limit minus the Therm Hysteresis, the corresponding Status bits will be automatically cleared. The  $\overline{\text{THERM}}$  bit in the STATUS register will be cleared when all individual channel THERM bits are cleared.

Bit	7	6	5	4	3	2	1	0
				E4THERM	E3THERM	E2THERM	E1THERM	ITHERM
Access				RO	RO	RO	RO	RO
Reset				0	0	0	0	0

#### Bit 4 – E4THERM

This bit is set when the External Diode 4 channel exceeds its programmed Therm Limit. When set, this bit will assert the  $\overline{\text{THERM}}$  pin.

Value	Description
1	$\overline{\text{THERM}}$ pin asserted
0	$\overline{\text{THERM}}$ pin not asserted

#### Bit 3 – E3THERM

This bit is set when the External Diode 3 channel exceeds its programmed Therm Limit. When set, this bit will assert the  $\overline{\text{THERM}}$  pin.

Value	Description
1	$\overline{\text{THERM}}$ pin asserted
0	$\overline{\text{THERM}}$ pin not asserted

#### Bit 2 – E2THERM

This bit is set when the External Diode 2 channel exceeds its programmed Therm Limit. When set, this bit will assert the  $\overline{\text{THERM}}$  pin.

Value	Description
1	$\overline{\text{THERM}}$ pin asserted
0	$\overline{\text{THERM}}$ pin not asserted

#### Bit 1 – E1THERM

This bit is set when the External Diode 1 channel exceeds its programmed Therm Limit. When set, this bit will assert the  $\overline{\text{THERM}}$  pin.

Value	Description
1	$\overline{\text{THERM}}$ pin asserted
0	$\overline{\text{THERM}}$ pin not asserted

# Multi-Channel Low-Voltage Remote Di...

## System Management Bus Protocol

---

---

### Bit 0 – I THERM

This bit is set when the Internal Diode channel exceeds its programmed Therm Limit. When set, this bit will assert the  $\overline{\text{THERM}}$  pin.

Value	Description
1	$\overline{\text{THERM}}$ pin asserted
0	$\overline{\text{THERM}}$ pin not asserted

# Multi-Channel Low-Voltage Remote Di...

## System Management Bus Protocol

### 6.10.27 Rate Of Change Gain Register (Address 3Dh)

**Name:** ROC GAIN  
**Offset:** 0x3D

Bit	7	6	5	4	3	2	1	0
	RC1G[7:0]							
Access	RW	RW	RW	RW	RW	RW	RW	RW
Reset	0	0	0	0	0	0	0	0

**Bits 5:3 – RC2/3G[2:0]** This represents the binary gain applied to the difference equation.

Value	Description
0	1
1	2
2	4
3	8
4	16
5	32
6	64
7	128

**Bits 7:0 – RC1G[7:0]** This represents the binary gain applied to the difference equation.

Value	Description
0	1
1	2
2	4
3	8
4	16
5	32
6	64
7	128

# Multi-Channel Low-Voltage Remote Di...

## System Management Bus Protocol

### 6.10.28 Rate Of Change Configuration Register (Address 3Eh)

**Name:** ROC CONFIG  
**Offset:** 0x3E

	7	6	5	4	3	2	1	0
			EN_ROC	MASK2/3	MASK1	RCHY[2:0]		
Access			RW	RW	RW	RW	RW	RW
Reset			0	0	0	0	0	0

**Bit 5 – EN\_ROC** Enables the Rate of Change calculations.

Value	Description
1	Rate of Change enabled
0	Rate of Change disabled

**Bit 4 – MASK2/3**

Masks an event from setting the  $\overline{\text{ALERT}}$  pin from Channel 2.

Value	Description
1	Event is masked
0	Event will assert the $\overline{\text{ALERT}}$ pin

**Bit 3 – MASK1**

Masks an event from setting the  $\overline{\text{ALERT}}$  pin Channel 1.

Value	Description
1	Event is masked
0	Event will assert the $\overline{\text{ALERT}}$ pin

**Bits 2:0 – RCHY[2:0]** Hysteresis setting for Rate of Change Slope reversal. Deviations greater than this setting will result in the bit being set.

Value	Description
111	4.000 °C
110	3.000 °C
101	2.000 °C
100	1.000 °C
011	0.500 °C
010	0.250 °C
001	0.125 °C
000	0.000 °C

# Multi-Channel Low-Voltage Remote Di...

## System Management Bus Protocol

### 6.10.29 Rate Of Change Status Register (Address 3Fh)

**Name:** ROC STATUS  
**Offset:** 0x3F

Bit	7	6	5	4	3	2	1	0
	SLCG2/3	SLCG1	R2/3ODD	R1ODD	RC2/3HI	RC1HI	RC2/3LO	RC1LO
Access	RO	RO	RO	RO	RC	RC	RC	RC
Reset	0	0	0	0	0	0	0	0

**Bit 7 – SLCG2/3** Reports a change in slope during the Rate of Change calculation for External Channel 2.

Value	Description
1	Slope changed direction
0	Monotonic slope

**Bit 6 – SLCG1** Reports a change in slope during the Rate of Change calculation for External Channel 1.

Value	Description
1	Slope changed direction
0	Monotonic slope

**Bit 5 – R2/3ODD** Indicates whether the number of slope reversals was even or odd.

Value	Description
1	Odd number of slope reversals during the sampling period
0	Even number of reversals during the sampling period

**Bit 4 – R1ODD** Indicates whether the number of slope reversals was even or odd.

Value	Description
1	Odd number of slope reversals during the sampling period
0	Even number of reversals during the sampling period

**Bit 3 – RC2/3HI** This bit is set when the Rate of Change Results for External Diode 2 exceeds its programmed limit.

Value	Description
1	High limit exceeded
0	High limit not exceeded

**Bit 2 – RC1HI** This bit is set when the Rate of Change Results for External Diode 1 exceeds its programmed limit.

Value	Description
1	High limit exceeded
0	High limit not exceeded

# Multi-Channel Low-Voltage Remote Di...

## System Management Bus Protocol

**Bit 1 – RC2/3LO** This bit is set when the Rate of Change Results for External Diode 2 exceeds its programmed limit (applies when slope limit is negative).

Value	Description
1	Low limit exceeded
0	Low limit not exceeded

**Bit 0 – RC1LO** This bit is set when the Rate of Change Results for External Diode 1 exceeds its programmed limit (applies when slope limit is negative).

Value	Description
1	Low limit exceeded
0	Low limit not exceeded



# Multi-Channel Low-Voltage Remote Di...

## System Management Bus Protocol

### 6.10.30 Rate Of Change Results High Byte Register (n) (Addresses 40h and 44h)

**Name:** R RESH  
**Offset:** 0x40 + n\*0x04 [n=0..1]

Bit	7	6	5	4	3	2	1	0
	R(N)RH[7:0]							
Access	RO	RO	RO	RO	RO	RO	RO	RO
Reset	0	0	0	0	0	0	0	0

**Bits 7:0 – R(N)RH[7:0]** This is the high byte of the result of the most recent Rate of Change calculations where N = 1 or 2 corresponding to the remote diode channel.

# Multi-Channel Low-Voltage Remote Di... System Management Bus Protocol

## 6.10.31 Rate Of Change Results Low Byte Register (Address 45h)

**Name:** R2/3 RESL  
**Offset:** 0x45

Bit	7	6	5	4	3	2	1	0
	R2/3_RL[3:0]				R1_RL[3:0]			
Access	RO	RO	RO	RO	RO	RO	RO	RO
Reset	0	0	0	0	0	0	0	0

**Bits 7:4 – R2/3\_RL[3:0]** This is the low byte of the result of the most recent Rate of Change calculations for remote diode channel 2.

**Bits 3:0 – R1\_RL[3:0]** This is the low byte of the result of the most recent Rate of Change calculations for remote diode channel 1.

# Multi-Channel Low-Voltage Remote Di... System Management Bus Protocol

## 6.10.32 Rate Of Change Alert Limit High Byte Register (n) (Address 41h and 46h)

**Name:** R LIMH  
**Offset:** 0x41 + n\*0x05 [n=0..1]

Bit	7	6	5	4	3	2	1	0
	R(N)LIMH[7:0]							
Access	RW	RW	RW	RW	RW	RW	RW	RW
Reset	0	0	0	0	0	0	0	0

### Bits 7:0 – R(N)LIMH[7:0]

This is the high byte ROC ALERT limit. If the ROC results exceed this value and the MASK bit is not set, the ALERT pin will assert, where N = 1 or 2 corresponding to the remote diode channel.

# Multi-Channel Low-Voltage Remote Di... System Management Bus Protocol

## 6.10.33 Rate Of Change Alert Limit Low Byte Register (n) (Address 42h and 47h)

**Name:** R LIML  
**Offset:** 0x42 + n\*0x05 [n=0..1]

Bit	7	6	5	4	3	2	1	0
	R(N)LIML[3:0]							
Access	RW	RW	RW	RW				
Reset	0	0	0	0				

**Bits 7:4 – R(N)LIML[3:0]** This is the low byte ROC ALERT limit, where N = 1 or 2 corresponding to the remote diode channel.

# Multi-Channel Low-Voltage Remote Di...

## System Management Bus Protocol

### 6.10.34 Rate Of Change Samples Register (Address 43h and 48h)

**Name:** R SMPL  
**Offset:** 0x43 + n\*0x05 [n=0..1]

	7	6	5	4	3	2	1	0
					R(N)SH[3:0]			
Access					RW	RW	RW	RW
Reset					0	0	0	0

**Bits 3:0 – R(N)SH[3:0]** This represents the high byte of the number of samples taken for the Rate of Change calculation, where N = 1 or 2 corresponding to the remote diode channel.

Value	Description
0x0	2 Samples
0x1	3 Samples
0x2	5 Samples
0x3	9 Samples
0x4	17 Samples
0x5	33 Samples
0x6	65 Samples
0x7	129 Samples
0x8–0xF	257 Samples

# Multi-Channel Low-Voltage Remote Di... System Management Bus Protocol

## 6.10.35 Sample Period Max Temperature High Byte Data Register (Address 49h and 4Bh)

**Name:** PER MAXTH  
**Offset:** 0x49 + n\*0x02 [n=0..1]

Bit	7	6	5	4	3	2	1	0
	GM(N)HB[7:0]							
Access	RO	RO	RO	RO	RO	RO	RO	RO
Reset	0	0	0	0	0	0	0	0

**Bits 7:0 – GM(N)HB[7:0]** Integer value of the internal diode maximum temperature reading within the sample period.

# Multi-Channel Low-Voltage Remote Di...

## System Management Bus Protocol

### 6.10.36 Sample Period Max Temperature Low Byte Data Register (Address 4Ah and 4Ch)

**Name:** PER MAXTL  
**Offset:** 0x4A + n\*0x02 [n=0..1]

Bit	7	6	5	4	3	2	1	0
	PM(N)L[2:0]							
Access	RO	RO	RO					
Reset	0	0	0					

**Bits 7:5 – PM(N)L[2:0]** Fractional portion of the Internal Diode Temperature to be added to the value at register 00h.

Value	Description
111	0.875°C
110	0.750°C
101	0.625°C
100	0.500°C
011	0.375°C
010	0.250°C
001	0.125°C
000	0.000°C

# Multi-Channel Low-Voltage Remote Di... System Management Bus Protocol

## 6.10.37 Global Max Temperature High Byte Register (Address 4Dh and 4Fh)

**Name:** GBL MAXTH  
**Offset:** 0x4D + n\*0x02 [n=0..1]

Bit	7	6	5	4	3	2	1	0
	GM(N)HB[7:0]							
Access	RO	RO	RO	RO	RO	RO	RO	RO
Reset	0	0	0	0	0	0	0	0

**Bits 7:0 – GM(N)HB[7:0]** Integer value of the external diode N, maximum temperature reading within the sample period, where N = 1 or 2 corresponding to external diode 1 or 2.



# Multi-Channel Low-Voltage Remote Di...

## System Management Bus Protocol

### 6.10.38 Sample Period Max Temperature Low Byte Data Register (Address 4Eh and 50h)

**Name:** GBL MAXTL  
**Offset:** 0x4E + n\*0x02 [n=0..1]

Bit	7	6	5	4	3	2	1	0
	GM(N)LB[2:0]							
Access	RO	RO	RO					
Reset	0	0	0					

**Bits 7:5 – GM(N)LB[2:0]** Fractional portion of the External diode N, maximum temperature reading within the sample period, where N = 1 or 2 corresponding to external diode 1 or 2.

Value	Description
111	0.875 °C
110	0.750 °C
101	0.625 °C
100	0.500 °C
011	0.375 °C
010	0.250 °C
001	0.125 °C
000	0.000 °C

# Multi-Channel Low-Voltage Remote Di... System Management Bus Protocol

## 6.10.39 Filter Selection Register (Address 51h)

**Name:** FILTER SEL  
**Offset:** 0x51

Bit	7	6	5	4	3	2	1	0
							FILTER[1:0]	
Access							RW	RW
Reset							0	0

**Bits 1:0 – FILTER[1:0]** Control the level of digital filtering that is applied to the External Diode temperature measurement as shown in [Table 5-5](#).

# Multi-Channel Low-Voltage Remote Di... System Management Bus Protocol

## 6.10.40 Hottest Diode Temperature High Byte Register (Address 6Ah)

**Name:** HOTTEST DIODE HIGH BYTE  
**Offset:** 0x6A



**Bits 7:0 – HDHB[7:0]** Integer value of the hottest diode from the most recent samples.

# Multi-Channel Low-Voltage Remote Di...

## System Management Bus Protocol

### 6.10.41 Hottest Diode Temperature Low Byte Register (Address 6Bh)

**Name:** HOTTEST DIODE LOW BYTE  
**Offset:** 0x6B

Bit	7	6	5	4	3	2	1	0
	HDLB[2:0]							
Access	RO	RO	RO					
Reset	0	0	0					

**Bits 7:5 – HDLB[2:0]** Fractional portion of the hottest diode for the most recent sample period.

Value	Description
111	0.875 °C
110	0.750 °C
101	0.625 °C
100	0.500 °C
011	0.375 °C
010	0.250 °C
001	0.125 °C
000	0.000 °C

# Multi-Channel Low-Voltage Remote Di...

## System Management Bus Protocol

### 6.10.42 Hottest Diode Status Register (Address 6Ch)

**Name:** HOTTEST STATUS  
**Offset:** 0x6C

	Bit	7	6	5	4	3	2	1	0
					E4HOT	E3HOT	E2HOT	E1HOT	IHOT
Access					RO	RO	RO	RO	RO
Reset					0	0	0	0	0

**Bit 4 – E4HOT** Indicates External Diode 4 is the hottest.

Value	Description
1	External Diode 4 is hottest
0	External Diode 4 is not hottest

**Bit 3 – E3HOT** Indicates External Diode 3 is the hottest.

Value	Description
1	External Diode 3 is hottest
0	External Diode 3 is not hottest

**Bit 2 – E2HOT** Indicates External Diode 2 is the hottest.

Value	Description
1	External Diode 2 is hottest
0	External Diode 2 is not hottest

**Bit 1 – E1HOT** Indicates External Diode 1 is the hottest.

Value	Description
1	External Diode 1 is hottest
0	External Diode 1 is not hottest

**Bit 0 – IHOT** Indicates Internal Diode is the hottest.

Value	Description
1	Internal Diode is hottest
0	Internal Diode is not hottest

# Multi-Channel Low-Voltage Remote Di...

## System Management Bus Protocol

### 6.10.43 Hottest Diode Configuration Register (Address 6Dh)

**Name:** HOTTEST CONFIG  
**Offset:** 0x6D

	7	6	5	4	3	2	1	0
			REMHOT	E4ENB	E3ENB	E2ENB	E1ENB	IENB
Access			RW	RW	RW	RW	RW	RW
Reset			0	0	0	0	0	0

**Bit 5 – REMHOT** Enables the Remember Hottest function, so if the hottest diode changes, the ALERT pin is set.

Value	Description
1	Remember hottest function enabled
0	Remember hottest function disabled

**Bit 4 – E4ENB** Enables External Diode 4 for “Hottest of” comparisons.

Value	Description
1	External Diode 4 is enabled
0	External Diode 4 is not enabled

**Bit 3 – E3ENB** Enables External Diode 3 for “Hottest of” comparisons.

Value	Description
1	External Diode 3 is enabled
0	External Diode 3 is not enabled

**Bit 2 – E2ENB** Enables External Diode 2 for “Hottest of” comparisons.

Value	Description
1	External Diode 2 is enabled
0	External Diode 2 is not enabled

**Bit 1 – E1ENB** Enables External Diode 1 for “Hottest of” comparisons.

Value	Description
1	External Diode 1 is enabled
0	External Diode 1 is not enabled

**Bit 0 – IENB** Enables Internal Diode for “Hottest of” comparisons.

Value	Description
1	Internal Diode is enabled
0	Internal Diode is not enabled

# Multi-Channel Low-Voltage Remote Di...

## System Management Bus Protocol

### 6.10.44 Product ID Register (Address FDh)

**Name:** PRODUCT ID  
**Offset:** 0xFD

Bit	7	6	5	4	3	2	1	0
	PRODUCT_ID[7:0]							
Access	RO	RO	RO	RO	RO	RO	RO	RO
Reset								

**Bits 7:0 – PRODUCT\_ID[7:0]** Unique Product ID.

Value	Description
EMC1812-1/2/A	0x81
EMC1813-1/2/A	0x87
EMC1814-1/2/A	0x84
EMC1815-1/2/A	0x85
EMC1833-1/2/A	0x83

# Multi-Channel Low-Voltage Remote Di...

## System Management Bus Protocol

### 6.10.45 Manufacturer ID Register (Address FEh)

**Name:** MANUFACTURER ID  
**Offset:** 0xFE

Bit	7	6	5	4	3	2	1	0
	MCHP_ID[7:0]							
Access	RO	RO	RO	RO	RO	RO	RO	RO
Reset	0	1	0	1	0	1	0	0

**Bits 7:0 – MCHP\_ID[7:0]** Unique manufacturer ID for Microchip.



# Multi-Channel Low-Voltage Remote Di...

## System Management Bus Protocol

### 6.10.46 Revision - Revision Register (Address FFh)

**Name:** REVISION  
**Offset:** 0xFF

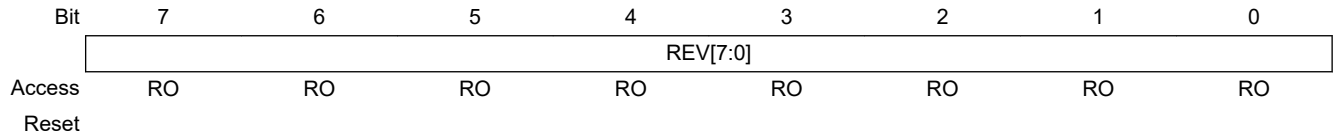

**Bits 7:0 – REV[7:0]** DIE revision number.

## 7. Packaging Information

### 7.1 Package Marking Information

8-Lead WDFN (2 x 2 mm)



Product Number	Code
EMC1812T-1E/RW	ABS
EMC1812T-2E/RW	ABT
EMC1812T-AE/RW	ABU
EMC1833T-1E/RW	ABY
EMC1833T-2E/RW	ABZ
EMC1833T-AE/RW	ACA



10-Lead VDFN (2.5 x 2.0 mm)



Product Number	Code
EMC1813T-1E/9R	8131
EMC1813T-2E/9R	8132
EMC1813T-AE/9R	813A
EMC1814T-1E/9R	8141
EMC1814T-2E/9R	8142
EMC1814T-AE/9R	814A
EMC1815T-1E/9R	8151
EMC1815T-2E/9R	8152
EMC1815T-AE/9R	815A



Legend:

- XX...X** Customer-specific information
- Y** Year code (last digit of calendar year)
- YY** Year code (last 2 digits of calendar year)
- WW** Week code (week of January 1 is week '01')
- NNN** Alphanumeric traceability code
- e3** JEDEC® designator for Matte Tin (Sn)

\* This package is RoHS compliant. The JEDEC designator ( **e3** ) can be found on the outer packaging for this package.

**Note:** In the event the full Microchip part number cannot be marked on one line, it will be carried over to the next line, thus limiting the number of available characters for customer-specific information.

# Multi-Channel Low-Voltage Remote Di...

## Packaging Information

### 8-Lead Very, Very Thin Plastic Dual Flat, No Lead Package (RW) - 2x2 mm Body [WDFN]

**Note:** For the most current package drawings, please see the Microchip Packaging Specification located at <http://www.microchip.com/packaging>



Microchip Technology Drawing C04-261A Sheet 1 of 2

# Multi-Channel Low-Voltage Remote Di...

## Packaging Information

### 8-Lead Very, Very Thin Plastic Dual Flat, No Lead Package (RW) - 2x2 mm Body [WDFN]

**Note:** For the most current package drawings, please see the Microchip Packaging Specification located at <http://www.microchip.com/packaging>

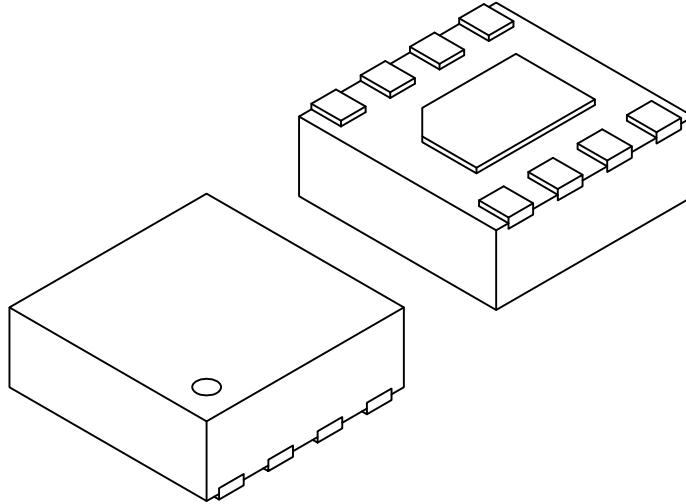

Dimension Limits	Units	MILLIMETERS		
		MIN	NOM	MAX
Number of Terminals	N	8		
Pitch	e	0.50 BSC		
Overall Height	A	0.70	0.75	0.80
Standoff	A1	0.00	0.02	0.05
Terminal Thickness	(A3)	0.10 REF		
Overall Width	E	2.00 BSC		
Exposed Pad Width	E2	0.70	0.80	0.90
Overall Length	D	2.00 BSC		
Exposed Pad Length	D2	1.10	1.20	1.30
Exposed Pad Chamfer	CH	-	0.25	-
Terminal Width	b	0.20	0.25	0.30
Terminal Length	L	0.25	0.30	0.35
Terminal-to-Exposed-Pad	(K)	0.30	-	-

**Notes:**

1. Pin 1 visual index feature may vary, but must be located within the hatched area.
2. Package is saw singulated
3. Dimensioning and tolerancing per ASME Y14.5M
  - BSC: Basic Dimension. Theoretically exact value shown without tolerances.
  - REF: Reference Dimension, usually without tolerance, for information purposes only.

Microchip Technology Drawing C04-261A Sheet 2 of 2

# Multi-Channel Low-Voltage Remote Di...

## Packaging Information

### 8-Lead Very, Very Thin Plastic Dual Flat, No Lead Package (RW) - 2x2 mm Body [WDFN]

**Note:** For the most current package drawings, please see the Microchip Packaging Specification located at <http://www.microchip.com/packaging>



#### RECOMMENDED LAND PATTERN

Units		MILLIMETERS		
Dimension Limits		MIN	NOM	MAX
Contact Pitch	E	0.50 BSC		
Optional Center Pad Width	Y2			0.90
Optional Center Pad Length	X2			1.30
Contact Pad Spacing	C		2.10	
Center Pad Chamfer	CH		0.28	
Contact Pad Width (X8)	X1			0.30
Contact Pad Length (X8)	Y1			0.70
Contact Pad to Contact Pad (X6)	G1	0.20		
Contact Pad to Center Pad (X8)	G1		0.25 REF	
Thermal Via Diameter	V		0.30	

**Notes:**

1. Dimensioning and tolerancing per ASME Y14.5M
  - BSC: Basic Dimension. Theoretically exact value shown without tolerances.
  - REF: Reference Dimension, usually without tolerances, for reference only.

Microchip Technology Drawing C04-2261A

# Multi-Channel Low-Voltage Remote Di...

## Packaging Information

### 10-Lead Very Thin Plastic Dual Flat, No Lead Package (9R) - 2.5x2.0 mm Body [VDFN]

**Note:** For the most current package drawings, please see the Microchip Packaging Specification located at <http://www.microchip.com/packaging>



Microchip Technology Drawing C04-332B Sheet 1 of 2

# Multi-Channel Low-Voltage Remote Di...

## Packaging Information

### 10-Lead Very Thin Plastic Dual Flat, No Lead Package (9R) - 2.5x2.0 mm Body [VDFN]

**Note:** For the most current package drawings, please see the Microchip Packaging Specification located at <http://www.microchip.com/packaging>



Units		MILLIMETERS		
Dimension Limits		MIN	NOM	MAX
Number of Pins	N	10		
Pitch	e	0.50 BSC		
Overall Height	A	0.80	0.85	0.90
Standoff	A1	0.00	0.02	0.05
Terminal Thickness	(A3)	0.10 REF		
Overall Length	D	2.50 BSC		
Overall Width	E	2.00 BSC		
Terminal Width	b	0.20	0.25	0.30
Terminal Length	L	0.30	0.40	0.50

Notes:

1. Pin 1 visual index feature may vary, but must be located within the hatched area.
2. Package is saw singulated
3. Dimensioning and tolerancing per ASME Y14.5M
  - BSC: Basic Dimension. Theoretically exact value shown without tolerances.
  - REF: Reference Dimension, usually without tolerance, for information purposes only.

Microchip Technology Drawing C04-332B Sheet 2 of 2

# Multi-Channel Low-Voltage Remote Di...

## Packaging Information

### 10-Lead Very Thin Plastic Dual Flat, No Lead Package (9R) - 2.5x2.0 mm Body [VDFN]

**Note:** For the most current package drawings, please see the Microchip Packaging Specification located at <http://www.microchip.com/packaging>



Dimension Limits	Units	MILLIMETERS		
		MIN	NOM	MAX
Contact Pitch	E	0.50 BSC		
Contact Pad Spacing	C		1.90	
Contact Pad Width (X10)	X1			0.30
Contact Pad Length (X10)	Y1			0.85
Contact Pad to Center Pad (X10)	G1	0.20		

**Notes:**

1. Dimensioning and tolerancing per ASME Y14.5M

BSC: Basic Dimension. Theoretically exact value shown without tolerances.

Microchip Technology Drawing C04-2332A



**8. Revision History**

**Revision A (October 2018)**

Original release of the document.

# Multi-Channel Low-Voltage Remote Diode Sensor Family

---

---

## The Microchip Web Site

---

Microchip provides online support via our web site at <http://www.microchip.com/>. This web site is used as a means to make files and information easily available to customers. Accessible by using your favorite Internet browser, the web site contains the following information:

- **Product Support** – Data sheets and errata, application notes and sample programs, design resources, user's guides and hardware support documents, latest software releases and archived software
- **General Technical Support** – Frequently Asked Questions (FAQ), technical support requests, online discussion groups, Microchip consultant program member listing
- **Business of Microchip** – Product selector and ordering guides, latest Microchip press releases, listing of seminars and events, listings of Microchip sales offices, distributors and factory representatives

## Customer Change Notification Service

---

Microchip's customer notification service helps keep customers current on Microchip products. Subscribers will receive e-mail notification whenever there are changes, updates, revisions or errata related to a specified product family or development tool of interest.

To register, access the Microchip web site at <http://www.microchip.com/>. Under "Support", click on "Customer Change Notification" and follow the registration instructions.

## Customer Support

---

Users of Microchip products can receive assistance through several channels:

- Distributor or Representative
- Local Sales Office
- Field Application Engineer (FAE)
- Technical Support

Customers should contact their distributor, representative or Field Application Engineer (FAE) for support. Local sales offices are also available to help customers. A listing of sales offices and locations is included in the back of this document.

Technical support is available through the web site at: <http://www.microchip.com/support>

# Multi-Channel Low-Voltage Remote Diode Sensor Family

## Product Identification System

To order or obtain information, e.g., on pricing or delivery, refer to the factory or the listed sales office.

**PART NO.**    **[X]<sup>(1)</sup>**    **X**    **-X**    **/XX**  
 Device    Tape    SMBUS    Temp.    Package  
                  and Reel    Address    Range

Device:	EMC1812: High-Accuracy, Low-Cost, 2-wire Temperature Sensor EMC1813: High-Accuracy, Low-Cost, 2-wire Temperature Sensor EMC1814: High-Accuracy, Low-Cost, 2-wire Temperature Sensor EMC1815: High-Accuracy, Low-Cost, 2-wire Temperature Sensor EMC1833: High-Accuracy, Low-Cost, 2-wire Temperature Sensor	
Tape and Reel Option:	Blank	= Standard packaging (tube or tray)
	T	= Tape and Reel
SMBus Address:	1	= 1001_100(r/w)
	2	= 1000_101(r/w)
	A	= Adjustable
Temperature Range:	I	= -40°C to +85°C (Industrial)
	E	= -40°C to +125°C (Extended)
Package:	RW	= 8-Lead Very, Very Thin Plastic Dual Flat, No Lead – 2 x 2 mm Body (WDFN)= UQFN
	9R	= 10-Lead Very Thin Plastic Dual Flat, No Lead – 2.5 x 2.0 mm Body (VDFN)

### Examples:

- EMC1812T-AE/RW:Tape and reel, Adjustable, Extended temperature, 8L-WDFN package
- EMC1812T-1E/RW:Tape and reel, 1001\_100(r/w), Extended temperature, 8L-WDFN package
- EMC1833T-2E/RW:Tape and reel 1000\_101(r/w), Extended temperature, 8L-WDFN package
- EMC1813T-2E/9R:Tape and reel 1000\_101(r/w), Extended temperature, 10L-VDFN package
- EMC1814T-AE/9R:Tape and reel, Adjustable Extended temperature, 10L-VDFN package
- EMC1815T-1E/9R:Tape and reel, 1001\_100(r/w), Extended temperature, 10L-VDFN package
- EMC1815T-2E/9R:Tape and reel, 1000\_101(r/w), Extended temperature, 10L-VDFN package

### Note:

1. Tape and Reel identifier only appears in the catalog part number description. This identifier is used for ordering purposes and is not printed on the device package. Check with your Microchip Sales Office for package availability with the Tape and Reel option.
2. Small form-factor packaging options may be available. Please check <http://www.microchip.com/packaging> for small-form factor package availability, or contact your local Sales Office.

# Multi-Channel Low-Voltage Remote Diode Sensor Family

---

## Microchip Devices Code Protection Feature

---

Note the following details of the code protection feature on Microchip devices:

- Microchip products meet the specification contained in their particular Microchip Data Sheet.
- Microchip believes that its family of products is one of the most secure families of its kind on the market today, when used in the intended manner and under normal conditions.
- There are dishonest and possibly illegal methods used to breach the code protection feature. All of these methods, to our knowledge, require using the Microchip products in a manner outside the operating specifications contained in Microchip's Data Sheets. Most likely, the person doing so is engaged in theft of intellectual property.
- Microchip is willing to work with the customer who is concerned about the integrity of their code.
- Neither Microchip nor any other semiconductor manufacturer can guarantee the security of their code. Code protection does not mean that we are guaranteeing the product as "unbreakable."

Code protection is constantly evolving. We at Microchip are committed to continuously improving the code protection features of our products. Attempts to break Microchip's code protection feature may be a violation of the Digital Millennium Copyright Act. If such acts allow unauthorized access to your software or other copyrighted work, you may have a right to sue for relief under that Act.

## Legal Notice

---

Information contained in this publication regarding device applications and the like is provided only for your convenience and may be superseded by updates. It is your responsibility to ensure that your application meets with your specifications. MICROCHIP MAKES NO REPRESENTATIONS OR WARRANTIES OF ANY KIND WHETHER EXPRESS OR IMPLIED, WRITTEN OR ORAL, STATUTORY OR OTHERWISE, RELATED TO THE INFORMATION, INCLUDING BUT NOT LIMITED TO ITS CONDITION, QUALITY, PERFORMANCE, MERCHANTABILITY OR FITNESS FOR PURPOSE. Microchip disclaims all liability arising from this information and its use. Use of Microchip devices in life support and/or safety applications is entirely at the buyer's risk, and the buyer agrees to defend, indemnify and hold harmless Microchip from any and all damages, claims, suits, or expenses resulting from such use. No licenses are conveyed, implicitly or otherwise, under any Microchip intellectual property rights unless otherwise stated.

## Trademarks

---

The Microchip name and logo, the Microchip logo, AnyRate, AVR, AVR logo, AVR Freaks, BitCloud, chipKIT, chipKIT logo, CryptoMemory, CryptoRF, dsPIC, FlashFlex, flexPWR, Helder, JukeBlox, KeeLoq, Klear, LANCheck, LINK MD, maXStylus, maXTouch, MediaLB, megaAVR, MOST, MOST logo, MPLAB, OptoLyzer, PIC, picoPower, PICSTART, PIC32 logo, Prochip Designer, QTouch, SAM-BA, SpyNIC, SST, SST Logo, SuperFlash, tinyAVR, UNI/O, and XMEGA are registered trademarks of Microchip Technology Incorporated in the U.S.A. and other countries.

ClockWorks, The Embedded Control Solutions Company, EtherSynch, Hyper Speed Control, HyperLight Load, IntelliMOS, mTouch, Precision Edge, and Quiet-Wire are registered trademarks of Microchip Technology Incorporated in the U.S.A.

Adjacent Key Suppression, AKS, Analog-for-the-Digital Age, Any Capacitor, AnyIn, AnyOut, BodyCom, CodeGuard, CryptoAuthentication, CryptoAutomotive, CryptoCompanion, CryptoController, dsPICDEM, dsPICDEM.net, Dynamic Average Matching, DAM, ECAN, EtherGREEN, In-Circuit Serial Programming, ICSP, INICnet, Inter-Chip Connectivity, JitterBlocker, KlearNet, KlearNet logo, memBrain, Mindi, MiWi,

# Multi-Channel Low-Voltage Remote Diode Sensor Family

---

motorBench, MPASM, MPF, MPLAB Certified logo, MPLIB, MPLINK, MultiTRAK, NetDetach, Omniscient Code Generation, PICDEM, PICDEM.net, PICKit, PICtail, PowerSmart, PureSilicon, QMatrix, REAL ICE, Ripple Blocker, SAM-ICE, Serial Quad I/O, SMART-I.S., SQI, SuperSwitcher, SuperSwitcher II, Total Endurance, TSHARC, USBCheck, VariSense, ViewSpan, WiperLock, Wireless DNA, and ZENA are trademarks of Microchip Technology Incorporated in the U.S.A. and other countries.

SQTP is a service mark of Microchip Technology Incorporated in the U.S.A.

Silicon Storage Technology is a registered trademark of Microchip Technology Inc. in other countries.

GestIC is a registered trademark of Microchip Technology Germany II GmbH & Co. KG, a subsidiary of Microchip Technology Inc., in other countries.

All other trademarks mentioned herein are property of their respective companies.

© 2018, Microchip Technology Incorporated, Printed in the U.S.A., All Rights Reserved.

ISBN: 978-1-5224-3630-0

## Quality Management System Certified by DNV

---

### ISO/TS 16949

Microchip received ISO/TS-16949:2009 certification for its worldwide headquarters, design and wafer fabrication facilities in Chandler and Tempe, Arizona; Gresham, Oregon and design centers in California and India. The Company's quality system processes and procedures are for its PIC<sup>®</sup> MCUs and dsPIC<sup>®</sup> DSCs, KEELOQ<sup>®</sup> code hopping devices, Serial EEPROMs, microperipherals, nonvolatile memory and analog products. In addition, Microchip's quality system for the design and manufacture of development systems is ISO 9001:2000 certified.

## Worldwide Sales and Service

AMERICAS	ASIA/PACIFIC	ASIA/PACIFIC	EUROPE
<p><b>Corporate Office</b> 2355 West Chandler Blvd. Chandler, AZ 85224-6199 Tel: 480-792-7200 Fax: 480-792-7277 Technical Support: <a href="http://www.microchip.com/support">http://www.microchip.com/support</a> Web Address: <a href="http://www.microchip.com">www.microchip.com</a></p> <p><b>Atlanta</b> Duluth, GA Tel: 678-957-9614 Fax: 678-957-1455</p> <p><b>Austin, TX</b> Tel: 512-257-3370</p> <p><b>Boston</b> Westborough, MA Tel: 774-760-0087 Fax: 774-760-0088</p> <p><b>Chicago</b> Itasca, IL Tel: 630-285-0071 Fax: 630-285-0075</p> <p><b>Dallas</b> Addison, TX Tel: 972-818-7423 Fax: 972-818-2924</p> <p><b>Detroit</b> Novi, MI Tel: 248-848-4000</p> <p><b>Houston, TX</b> Tel: 281-894-5983</p> <p><b>Indianapolis</b> Noblesville, IN Tel: 317-773-8323 Fax: 317-773-5453 Tel: 317-536-2380</p> <p><b>Los Angeles</b> Mission Viejo, CA Tel: 949-462-9523 Fax: 949-462-9608 Tel: 951-273-7800</p> <p><b>Raleigh, NC</b> Tel: 919-844-7510</p> <p><b>New York, NY</b> Tel: 631-435-6000</p> <p><b>San Jose, CA</b> Tel: 408-735-9110 Tel: 408-436-4270</p> <p><b>Canada - Toronto</b> Tel: 905-695-1980 Fax: 905-695-2078</p>	<p><b>Australia - Sydney</b> Tel: 61-2-9868-6733</p> <p><b>China - Beijing</b> Tel: 86-10-8569-7000</p> <p><b>China - Chengdu</b> Tel: 86-28-8665-5511</p> <p><b>China - Chongqing</b> Tel: 86-23-8980-9588</p> <p><b>China - Dongguan</b> Tel: 86-769-8702-9880</p> <p><b>China - Guangzhou</b> Tel: 86-20-8755-8029</p> <p><b>China - Hangzhou</b> Tel: 86-571-8792-8115</p> <p><b>China - Hong Kong SAR</b> Tel: 852-2943-5100</p> <p><b>China - Nanjing</b> Tel: 86-25-8473-2460</p> <p><b>China - Qingdao</b> Tel: 86-532-8502-7355</p> <p><b>China - Shanghai</b> Tel: 86-21-3326-8000</p> <p><b>China - Shenyang</b> Tel: 86-24-2334-2829</p> <p><b>China - Shenzhen</b> Tel: 86-755-8864-2200</p> <p><b>China - Suzhou</b> Tel: 86-186-6233-1526</p> <p><b>China - Wuhan</b> Tel: 86-27-5980-5300</p> <p><b>China - Xian</b> Tel: 86-29-8833-7252</p> <p><b>China - Xiamen</b> Tel: 86-592-2388138</p> <p><b>China - Zhuhai</b> Tel: 86-756-3210040</p>	<p><b>India - Bangalore</b> Tel: 91-80-3090-4444</p> <p><b>India - New Delhi</b> Tel: 91-11-4160-8631</p> <p><b>India - Pune</b> Tel: 91-20-4121-0141</p> <p><b>Japan - Osaka</b> Tel: 81-6-6152-7160</p> <p><b>Japan - Tokyo</b> Tel: 81-3-6880-3770</p> <p><b>Korea - Daegu</b> Tel: 82-53-744-4301</p> <p><b>Korea - Seoul</b> Tel: 82-2-554-7200</p> <p><b>Malaysia - Kuala Lumpur</b> Tel: 60-3-7651-7906</p> <p><b>Malaysia - Penang</b> Tel: 60-4-227-8870</p> <p><b>Philippines - Manila</b> Tel: 63-2-634-9065</p> <p><b>Singapore</b> Tel: 65-6334-8870</p> <p><b>Taiwan - Hsin Chu</b> Tel: 886-3-577-8366</p> <p><b>Taiwan - Kaohsiung</b> Tel: 886-7-213-7830</p> <p><b>Taiwan - Taipei</b> Tel: 886-2-2508-8600</p> <p><b>Thailand - Bangkok</b> Tel: 66-2-694-1351</p> <p><b>Vietnam - Ho Chi Minh</b> Tel: 84-28-5448-2100</p>	<p><b>Austria - Wels</b> Tel: 43-7242-2244-39 Fax: 43-7242-2244-393</p> <p><b>Denmark - Copenhagen</b> Tel: 45-4450-2828 Fax: 45-4485-2829</p> <p><b>Finland - Espoo</b> Tel: 358-9-4520-820</p> <p><b>France - Paris</b> Tel: 33-1-69-53-63-20 Fax: 33-1-69-30-90-79</p> <p><b>Germany - Garching</b> Tel: 49-8931-9700</p> <p><b>Germany - Haan</b> Tel: 49-2129-3766400</p> <p><b>Germany - Heilbronn</b> Tel: 49-7131-67-3636</p> <p><b>Germany - Karlsruhe</b> Tel: 49-721-625370</p> <p><b>Germany - Munich</b> Tel: 49-89-627-144-0 Fax: 49-89-627-144-44</p> <p><b>Germany - Rosenheim</b> Tel: 49-8031-354-560</p> <p><b>Israel - Ra'anana</b> Tel: 972-9-744-7705</p> <p><b>Italy - Milan</b> Tel: 39-0331-742611 Fax: 39-0331-466781</p> <p><b>Italy - Padova</b> Tel: 39-049-7625286</p> <p><b>Netherlands - Drunen</b> Tel: 31-416-690399 Fax: 31-416-690340</p> <p><b>Norway - Trondheim</b> Tel: 47-7289-7561</p> <p><b>Poland - Warsaw</b> Tel: 48-22-3325737</p> <p><b>Romania - Bucharest</b> Tel: 40-21-407-87-50</p> <p><b>Spain - Madrid</b> Tel: 34-91-708-08-90 Fax: 34-91-708-08-91</p> <p><b>Sweden - Gothenberg</b> Tel: 46-31-704-60-40</p> <p><b>Sweden - Stockholm</b> Tel: 46-8-5090-4654</p> <p><b>UK - Wokingham</b> Tel: 44-118-921-5800 Fax: 44-118-921-5820</p>

# Mouser Electronics

Authorized Distributor

Click to View Pricing, Inventory, Delivery & Lifecycle Information:

## Microchip:

[EMC1812T-1E/RW](#) [EMC1813T-2E/9R](#) [EMC1814T-2E/9R](#) [EMC1814T-AE/9R](#) [EMC1815T-AE/9R](#) [EMC1813T-AE/9R](#)  
[EMC1812T-2E/RW](#) [EMC1833T-AE/RW](#) [EMC1812T-AE/RW](#) [EMC1813T-1E/9R](#) [EMC1815T-1E/9R](#) [EMC1814T-1E/9R](#) [EMC1815T-2E/9R](#)

Компания «Life Electronics» занимается поставками электронных компонентов импортного и отечественного производства от производителей и со складов крупных дистрибьюторов Европы, Америки и Азии.

С конца 2013 года компания активно расширяет линейку поставок компонентов по направлению коаксиальный кабель, кварцевые генераторы и конденсаторы (керамические, пленочные, электролитические), за счёт заключения дистрибьюторских договоров

Мы предлагаем:

- Конкурентоспособные цены и скидки постоянным клиентам.
- Специальные условия для постоянных клиентов.
- Подбор аналогов.
- Поставку компонентов в любых объемах, удовлетворяющих вашим потребностям.
- Приемлемые сроки поставки, возможна ускоренная поставка.
- Доставку товара в любую точку России и стран СНГ.
- Комплексную поставку.
- Работу по проектам и поставку образцов.
- Формирование склада под заказчика.
- Сертификаты соответствия на поставляемую продукцию (по желанию клиента).
- Тестирование поставляемой продукции.
- Поставку компонентов, требующих военную и космическую приемку.
- Входной контроль качества.
- Наличие сертификата ISO.

В составе нашей компании организован Конструкторский отдел, призванный помогать разработчикам, и инженерам.

Конструкторский отдел помогает осуществить:

- Регистрацию проекта у производителя компонентов.
- Техническую поддержку проекта.
- Защиту от снятия компонента с производства.
- Оценку стоимости проекта по компонентам.
- Изготовление тестовой платы монтаж и пусконаладочные работы.



Тел: +7 (812) 336 43 04 (многоканальный)

Email: [org@lifeelectronics.ru](mailto:org@lifeelectronics.ru)