



# CeraDiodes

High-speed series

**Series/Type:**

Date: August 2012

## CeraDiodes

### High-speed series

#### SMD

#### Features

- Very low capacitance values 0.6 up to 10 pF
- ESD protection to IEC 61000-4-2, level 4
- Bidirectional ESD protection in one component
- No change in ESD protection performance at temperatures up to 85 °C (temperature derating)
- Low parasitic inductance
- Low leakage current
- Fast response time <0.5 ns
- Lead-free nickel barrier terminations suitable for lead-free soldering
- RoHS-compatible

#### Applications

- Interfaces, data lines (USB, IEEE 1394, Ethernet, parallel port, SATA, DisplayPort, etc.), audio lines (digital) and video lines (analog), DVI, HDMI, ICs and I/O ports
- Consumer electronic products (TV, DVD player/recorder, set-top box, game consoles, MP3 player, digital still/video camera, etc.)
- EDP products (desktop and notebook computer, monitor, PDA, printer, memory card, control unit, head set, speaker, HDD, optical drive, etc.)
- Industrial applications
- Mobile phone applications

#### Design

- Multilayer technology
- Nickel barrier termination (Ag/Ni/Sn) for lead-free soldering

#### Marking

- Due to the symmetrical configuration no marking information is needed.

Single chip



4-fold array



2/4 data + 1 supply



#### General technical data

|                                  |                       |                   |            |         |
|----------------------------------|-----------------------|-------------------|------------|---------|
| Maximum DC operating voltage     |                       | $V_{DC,max}$      | 5.6 ... 30 | V       |
| Typical capacitance              |                       | $C_{typ}$         | 0.6 ... 10 | pF      |
| Air discharge ESD capability     | to IEC 61000-4-2      | $V_{ESD,air}$     | 15         | kV      |
| Contact discharge ESD capability | to IEC 61000-4-2      | $V_{ESD,contact}$ | 8          | kV      |
| Leakage current                  | ( $V_{leak} = 5.6$ V) | $I_{leak}$        | 1          | $\mu$ A |
| Operating temperature            |                       | $T_{op}$          | -40/+85    | °C      |
| Storage temperature              |                       | LCT/UCT           | -40/+125   | °C      |

**CeraDiodes**
**High-speed series**
**SMD**
**Electrical specifications and ordering codes**
**Maximum ratings ( $T_{op,max} = 85\text{ °C}$ ) and characteristics ( $T_A = 25\text{ °C}$ )**

| Type   | Ordering code   | $V_{DC,max}$<br>V | $V_{BR,min}$<br>(1 mA)<br>V | $V_{clamp,max}$<br>(1 A)<br>V | $C_{typ}$<br>(1 MHz, 1 V)<br>pF | $C_{max}$<br>(1 MHz, 1 V)<br>pF |
|--|-----------------|-------------------|-----------------------------|-------------------------------|---------------------------------|---------------------------------|
| Array, 2/4 data + 1 supply, 0506, SOT-666              |                 |                   |                             |                               |                                 |                                 |
| CDA3C05GTH   | B72755D0050H062 | 5.6               | 106                         | 395                           | 2.2                             | 3.5                             |
| Array, 2/4 data + 1 supply, 1012, SOT-23 6L            |                 |                   |                             |                               |                                 |                                 |
| CDA6C05GTH   | B72735D0050H062 | 5.6               | 52                          | 195                           | 7                               | 10                              |
| Array, 4-fold, 0508, no semiconductor diode equivalent |                 |                   |                             |                               |                                 |                                 |
| CDA4C16GTH   | B72714D0160H060 | 16                | 22                          | 66                            | 10                              | 15                              |
| Array, 4-fold, 0612, no semiconductor diode equivalent |                 |                   |                             |                               |                                 |                                 |
| CDA5C16GTH   | B72724D0160H062 | 16                | 80                          | 350                           | 3                               | 5                               |
| Single, 0201, no semiconductor diode equivalent        |                 |                   |                             |                               |                                 |                                 |
| CDS1C05GTH1  | B72440C0050H160 | 5.5               | 17                          | 33                            | 7                               | -                               |
| CDS1C05GTH2  | B72440C0050H260 | 5.5               | 20                          | 66                            | 3                               | -                               |
| CDS1C05GTH   | B72440D0050H060 | 5.6               | 21                          | 70                            | 6                               | 10                              |
| Single, 0402, SOD-723                                  |                 |                   |                             |                               |                                 |                                 |
| CDS2C05HDMI1   | B72590D0050H160 | 5.6               | 150                         | -                             | 0.6                             | 0.9                             |
| CDS2C05HDMI2   | B72590D0050H260 | 5.6               | 90                          | -                             | 0.6                             | 0.9                             |
| CDS2C12GTH   | B72590D0120H060 | 12                | 20                          | 66                            | 4.5                             | -                               |
| CDS2C15GTH   | B72590D0150H060 | 15                | 23                          | 66                            | 10                              | 15                              |
| CDS2C16GTH   | B72590D0160H060 | 16                | 65                          | 290                           | 2                               | 3                               |
| CDS2C20GTH   | B72590D0200H060 | 20                | 30                          | 80                            | 10                              | 13                              |
| Single, 0603, SOD-523                                  |                 |                   |                             |                               |                                 |                                 |
| CDS3C05HDMI1   | B72500D0050H160 | 5.6               | 150                         | -                             | 0.6                             | 0.9                             |
| CDS3C16GTH   | B72500D0160H060 | 16                | 65                          | 290                           | 3                               | 5                               |
| CDS3C30GTH   | B72500D0300H060 | 30                | 50                          | 120                           | 10                              | 15                              |
| Single, 1003, SOD-323                                  |                 |                   |                             |                               |                                 |                                 |
| CDS4C16GTH   | B72570D0160H060 | 16                | 38                          | 146                           | 3                               | 5                               |

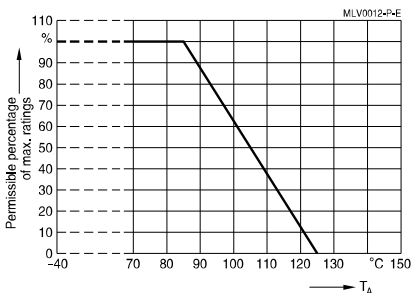
**Typical characteristics**

## CeraDiodes

### High-speed series

### SMD

#### Dimensional drawings

##### Single device

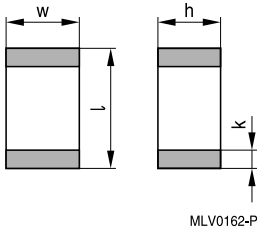

##### Dimensions in mm

| Case (inch)<br>size (mm) | 0201<br>0603 |      | 0402<br>1005 |      | 0603<br>1608 |      | 1003<br>2508 |      |
|--------------------------|--------------|------|--------------|------|--------------|------|--------------|------|
|                          | Min.         | Max. | Min.         | Max. | Min.         | Max. | Min.         | Max. |
| l                        | 0.57         | 0.63 | 0.85         | 1.15 | 1.45         | 1.75 | 2.34         | 2.74 |
| w                        | 0.27         | 0.33 | 0.4          | 0.6  | 0.7          | 0.9  | 0.7          | 0.9  |
| h                        | 0.27         | 0.33 | 0.4          | 0.6  | 0.7          | 0.9  | 0.7          | 0.9  |
| k                        | 0.1          | 0.2  | 0.1          | 0.3  | 0.1          | 0.4  | 0.13         | 0.75 |

##### Array devices

##### 4-fold array

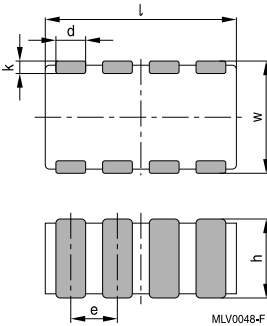

##### 2/4 data + 1 supply

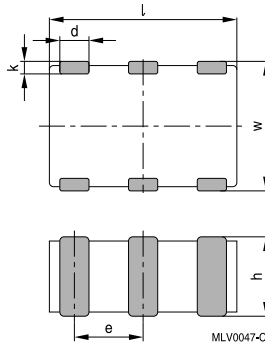

##### Dimension in mm

| Case size (inch)<br>(mm) | 0506<br>1216 |      | 0508<br>1220 |      | 0612<br>1632 |      | 1012<br>2532 |      |
|--------------------------|--------------|------|--------------|------|--------------|------|--------------|------|
|                          | Min.         | Max. | Min.         | Max. | Min.         | Max. | Min.         | Max. |
| l                        | 1.50         | 1.70 | 1.8          | 2.2  | 3.0          | 3.4  | 2.90         | 3.50 |
| w                        | 1.20         | 1.40 | 1.05         | 1.45 | 1.45         | 1.75 | 2.25         | 2.75 |
| h                        | -            | 0.6  | -            | 0.9  | -            | 0.9  | -            | 1.2  |
| d                        | 0.2          | 0.4  | 0.2          | 0.4  | 0.25         | 0.55 | 0.35         | 0.65 |
| e                        | 0.4          | 0.6  | 0.4          | 0.6  | 0.61         | 0.91 | 0.8          | 1.1  |
| k                        | -            | 0.35 | -            | 0.35 | -            | 0.35 | -            | 0.45 |

**SMD**

**Recommended solder pads**

Single device

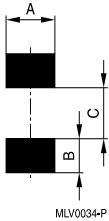

Dimensions in mm

| Case size (inch)<br>(mm) | 0201<br>0603 | 0402<br>1005 | 0603<br>1608 | 1003<br>2508 |
|--------------------------|--------------|--------------|--------------|--------------|
| A                        | 0.3          | 0.6          | 1.0          | 0.8          |
| B                        | 0.25         | 0.6          | 1.0          | 0.8          |
| C                        | 0.3          | 0.5          | 1.0          | 1.45         |

Array devices

4-fold array

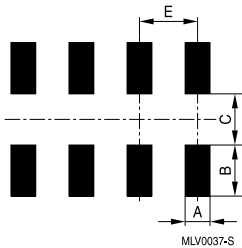

2/4 data + 1 supply

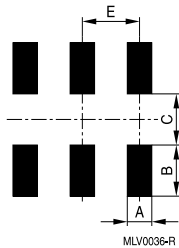

Dimensions in mm

| Case size (inch)<br>(mm) | 0506<br>1216 | 0508<br>1220 | 0612<br>1632 | 1012<br>2532 |
|--------------------------|--------------|--------------|--------------|--------------|
| A                        | 0.36         | 0.35         | 0.5          | 0.7          |
| B                        | 0.84         | 0.9          | 0.7          | 1.0          |
| C                        | 0.62         | 0.4          | 1.2          | 1.4          |
| E                        | 0.50         | 0.5          | 0.76         | 0.95         |

**CeraDiodes**

**High-speed series**

**SMD**

**Pin configurations**

Single device

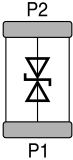

MLV0152-X

| Pin | Description |
|-----|-------------|
| P1  | GND         |
| P2  | I/O line    |

Array devices

4-fold array

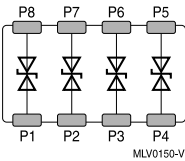

MLV0150-V

| Pin | Description |
|-----|-------------|
| P1  | GND         |
| P2  | GND         |
| P3  | GND         |
| P4  | GND         |
| P5  | I/O line 1  |
| P6  | I/O line 2  |
| P7  | I/O line 3  |
| P8  | I/O line 4  |

2/4 data + 1 supply

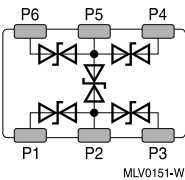

MLV0151-W

| Pin | Description |
|-----|-------------|
| P1  | I/O line 1  |
| P2  | GND         |
| P3  | I/O line 2  |
| P4  | I/O line 3  |
| P5  | $V_{DC}$    |
| P6  | I/O line 4  |

**CeraDiodes**

**High-speed series**

**SMD**

**Termination**

Single device

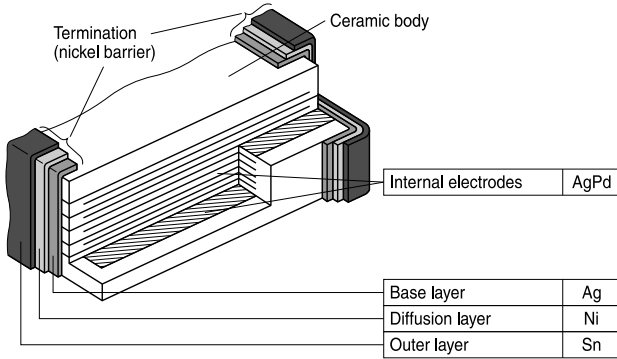

KKE0484-W-E

Array device

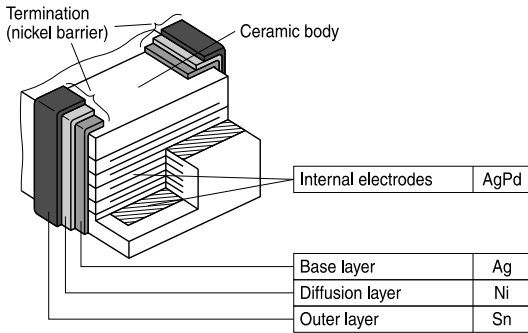

KKE0366-S-E

**CeraDiodes**
**High-speed series**
**SMD**
**Delivery mode**

| EIA case size | Taping    | Reel size<br>mm | Packing unit<br>pcs. | Type         | Ordering code   |
|---------------|-----------|-----------------|----------------------|--------------|-----------------|
| 0201          | Cardboard | 180             | 15000                | CDS1C05GTH   | B72440D0050H060 |
| 0201          | Cardboard | 180             | 15000                | CDS1C05GTH1  | B72440C0050H160 |
| 0201          | Cardboard | 180             | 15000                | CDS1C05GTH2  | B72440C0050H260 |
| 0402          | Cardboard | 180             | 10000                | CDS2C05HDMI1 | B72590D0050H160 |
| 0402          | Cardboard | 180             | 10000                | CDS2C05HDMI2 | B72590D0050H260 |
| 0402          | Cardboard | 180             | 10000                | CDS2C12GTH   | B72590D0120H060 |
| 0402          | Cardboard | 180             | 10000                | CDS2C15GTH   | B72590D0150H060 |
| 0402          | Cardboard | 180             | 10000                | CDS2C16GTH   | B72590D0160H060 |
| 0402          | Cardboard | 180             | 10000                | CDS2C20GTH   | B72590D0200H060 |
| 0506          | Blister   | 180             | 3000                 | CDA3C05GTH   | B72755D0050H062 |
| 0508          | Cardboard | 180             | 4000                 | CDA4C16GTH   | B72714D0160H060 |
| 0603          | Cardboard | 180             | 4000                 | CDS3C05HDMI1 | B72500D0050H160 |
| 0603          | Cardboard | 180             | 4000                 | CDS3C16GTH   | B72500D0160H060 |
| 0603          | Cardboard | 180             | 4000                 | CDS3C30GTH   | B72500D0300H060 |
| 0612          | Blister   | 180             | 3000                 | CDA5C16GTH   | B72724D0160H062 |
| 1003          | Cardboard | 180             | 4000                 | CDS4C16GTH   | B72570D0160H060 |
| 1012          | Blister   | 180             | 2000                 | CDA6C05GTH   | B72735D0050H062 |



**SMD**

**1 Taping and packing for chip and array CeraDiodes**

**1.1 Cardboard tape (taping to IEC 60286-3)**

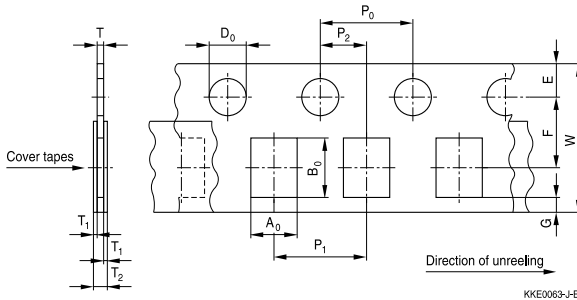

Dimensions in mm

| Case size (inch)<br>(mm)                   |                | 0201<br>0603           | 0402<br>1005 | 0603<br>1608 | 1003<br>2508 | 0508<br>1220 | Tolerance          |
|--|----------------|------------------------|--------------|--------------|--------------|--------------|--------------------|
| Compartment width                          | A <sub>0</sub> | 0.38 ±0.05             | 0.6          | 0.95         | 1.0          | 1.6          | ±0.2               |
| Compartment length                         | B <sub>0</sub> | 0.68 ±0.05             | 1.15         | 1.8          | 2.85         | 2.4          | ±0.2               |
| Sprocket hole diameter                     | D <sub>0</sub> | 1.5 ±0.1               | 1.5          | 1.5          | 1.5          | 1.5          | +0.1/ -0           |
| Sprocket hole pitch                        | P <sub>0</sub> | 4.0 ±0.1 <sup>1)</sup> | 4.0          | 4.0          | 4.0          | 4.0          | ±0.1 <sup>1)</sup> |
| Distance center hole to center compartment | P <sub>2</sub> | 2.0 ±0.05              | 2.0          | 2.0          | 2.0          | 2.0          | ±0.05              |
| Pitch of component compartments            | P <sub>1</sub> | 2.0 ±0.05              | 2.0          | 4.0          | 4.0          | 4.0          | ±0.1               |
| Tape width                                 | W              | 8.0 ±0.3               | 8.0          | 8.0          | 8.0          | 8.0          | ±0.3               |
| Distance edge to center of hole            | E              | 1.75 ±0.1              | 1.75         | 1.75         | 1.75         | 1.75         | ±0.1               |
| Distance center hole to center compartment | F              | 3.5 ±0.05              | 3.5          | 3.5          | 3.5          | 3.5          | ±0.05              |
| Distance compartment to edge               | G              | 1.35 min.              | 0.75         | 0.75         | 0.75         | 0.75         | min.               |
| Thickness tape                             | T              | 0.35 ±0.02             | 0.6          | 0.9          | 1.0          | 0.95         | max.               |
| Overall thickness                          | T <sub>2</sub> | 0.4 min.               | 0.7          | 1.1          | 1.1          | 1.12         | max.               |

<sup>1)</sup> ≤ ±0.2 mm over 10 sprocket holes

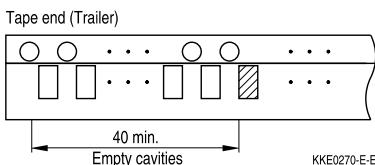

KKE0270-E-E

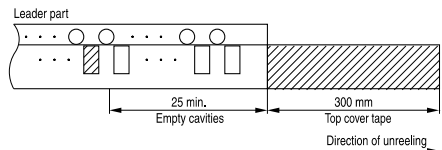

KKE0286-O-E

**SMD**

**1.2 Blister tape (taping to IEC 60286-3)**

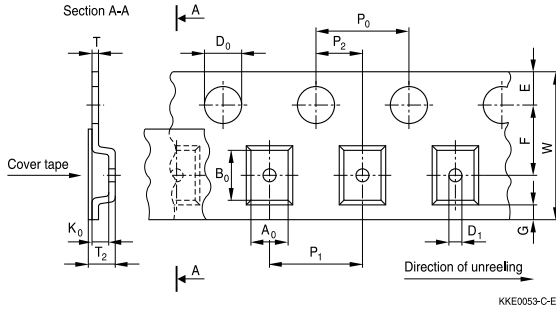

KKE0053-C-E

Dimensions in mm

| Case size (inch)<br>(mm)                   |                | 0506<br>1216 | 0612<br>1632 | 1012<br>2532 | Tolerance          |
|--|----------------|--------------|--------------|--------------|--------------------|
| Compartment width                          | A <sub>0</sub> | 1.5          | 1.9          | 2.8          | ±0.2               |
| Compartment length                         | B <sub>0</sub> | 1.8          | 3.5          | 3.5          | ±0.2               |
| Compartment height                         | K <sub>0</sub> | 0.8          | 1.8          | 1.8          | max.               |
| Sprocket hole diameter                     | D <sub>0</sub> | 1.5          | 1.5          | 1.5          | +0.1/ -0           |
| Compartment hole diameter                  | D <sub>1</sub> | 1.0          | 1.0          | 1.0          | min.               |
| Sprocket hole pitch                        | P <sub>0</sub> | 4.0          | 4.0          | 4.0          | ±0.1 <sup>1)</sup> |
| Distance center hole to center compartment | P <sub>2</sub> | 2.0          | 2.0          | 2.0          | ±0.05              |
| Pitch of component compartments            | P <sub>1</sub> | 4.0          | 4.0          | 4.0          | ±0.1               |
| Tape width                                 | W              | 8.0          | 8.0          | 8.0          | ±0.3               |
| Distance edge to center of hole            | E              | 1.75         | 1.75         | 1.75         | ±0.1               |
| Distance center hole to center compartment | F              | 3.5          | 3.5          | 3.5          | ±0.05              |
| Distance compartment to edge               | G              | 0.75         | 0.75         | 0.75         | min.               |
| Thickness tape                             | T              | 0.3          | 0.3          | 0.3          | max.               |
| Overall thickness                          | T <sub>2</sub> | 1.3          | 2.5          | 2.5          | max.               |

<sup>1)</sup> ≤ ±0.2 mm over 10 sprocket holes

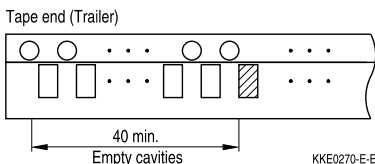

KKE0270-E-E

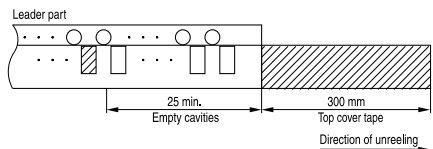

KKE0284-G-E

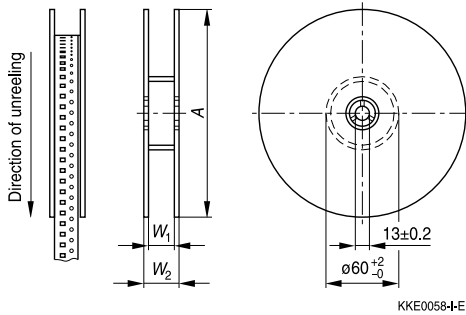
**1.3 Reel packing**

Dimensions in mm

|                      |                | <b>Dimensions</b> | <b>Tolerance</b> | <b>Dimensions</b> | <b>Tolerance</b> |
|----------------------|----------------|-------------------|------------------|-------------------|------------------|
| Reel diameter        | A              | 180               | +0/ -3           | 330               | ±2               |
| Reel width (inside)  | W <sub>1</sub> | 8.4               | +1.5/ -0         | 8.4               | +1.5/ -0         |
| Reel width (outside) | W <sub>2</sub> | 14.4              | max.             | 14.4              | max.             |

Package: 8-mm tape

Reel material: Plastic

**1.4 Packing units**

| <b>Case size<br/>(inch) / (mm)</b> | <b>∅ 180-mm reel<br/>pieces</b> | <b>∅ 330-mm reel<br/>pieces</b> | <b>Tape</b> |
|------------------------------------|---------------------------------|---------------------------------|-------------|
| 0201 / 0603                        | 15000                           | -                               | cardboard   |
| 0402 / 1005                        | 10000                           | 50000                           | cardboard   |
| 0603 / 1608                        | 4000                            | 16000                           | cardboard   |
| 1003 / 2508                        | 4000                            | 16000                           | cardboard   |
| 0506 / 1216                        | 3000                            | 12000                           | blister     |
| 0508 / 1220                        | 4000                            | 16000                           | cardboard   |
| 0612 / 1632                        | 3000                            | 12000                           | blister     |
| 1012 / 2532                        | 2000                            | 8000                            | blister     |

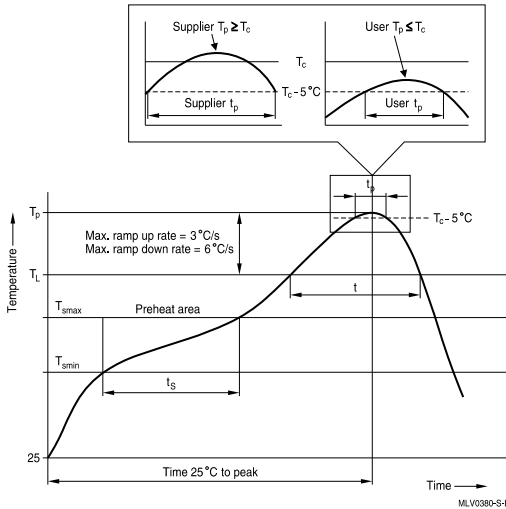
**Soldering directions**
**1 Reflow soldering temperature profile**
**Recommended temperature characteristic for reflow soldering following JEDEC J-STD-020D**

| Profile feature  |                          | Sn-Pb eutectic assembly         | Pb-free assembly                |
|--|--------------------------|---------------------------------|---------------------------------|
| Preheat and soak   |                          |                                 |                                 |
| - Temperature min  | $T_{smin}$               | 100 °C                          | 150 °C                          |
| - Temperature max  | $T_{smax}$               | 150 °C                          | 200 °C                          |
| - Time   | $t_{smin}$ to $t_{smax}$ | 60 ... 120 s                    | 60 ... 180 s                    |
| Average ramp-up rate   | $T_{smax}$ to $T_p$      | 3 °C/ s max.                    | 3 °C/ s max.                    |
| Liquidous temperature  | $T_L$                    | 183 °C                          | 217 °C                          |
| Time at liquidous  | $t_L$                    | 60 ... 150 s                    | 60 ... 150 s                    |
| Peak package body temperature  | $T_p^{1)}$               | 220 °C ... 235 °C <sup>2)</sup> | 245 °C ... 260 °C <sup>2)</sup> |
| Time ( $t_p$ ) <sup>3)</sup> within 5 °C of specified classification temperature ( $T_c$ ) |                          | 20 s <sup>3)</sup>              | 30 s <sup>3)</sup>              |
| Average ramp-down rate   | $T_p$ to $T_{smax}$      | 6 °C/ s max.                    | 6 °C/ s max.                    |
| Time 25 °C to peak temperature   |                          | maximum 6 min                   | maximum 8 min                   |

1) Tolerance for peak profile temperature ( $T_p$ ) is defined as a supplier minimum and a user maximum.

2) Depending on package thickness. For details please refer to JEDEC J-STD-020D.

3) Tolerance for time at peak profile temperature ( $t_p$ ) is defined as a supplier minimum and a user maximum.

**Note:** All temperatures refer to topside of the package, measured on the package body surface.  
Number of reflow cycles: 3

SMD

## 2 Soldering guidelines

The use of mild, non-activated fluxes for soldering is recommended, as well as proper cleaning of the PCB.

The components are suitable for reflow soldering to JEDEC J-STD-020D.

## 3 Solder joint profiles / solder quantity

### 3.1 Cement quantity

The component is fixed onto the circuit board with cement prior to soldering. It must still be able to move slightly. When the board is placed into the reflow oven, excessively rigid fixing can lead to high forces acting on the component and thus to a break. In addition, too much cement can lead to unsymmetrical stressing and thus to mechanical fracture of the component. The cement must also be so soft during mounting that no mechanical stressing occurs.

### 3.2 Mounting the components on the board

It is best to mount the components on the board before soldering so that one termination does not enter the oven first and the second termination is soldered subsequently. The ideal case is simultaneous wetting of both terminations.

### 3.3 Solder joint profiles

If the meniscus height is too low, that means the solder quantity is too low, the solder joint may break, i.e. the component becomes detached from the joint. This problem is sometimes interpreted as leaching of the external terminations.

If the solder meniscus is too high, i.e. the solder quantity is too large, the vise effect may occur. As the solder cools down, the solder contracts in the direction of the component. If there is too much solder on the component, it has no leeway to evade the stress and may break, as in a vise.

SMD

3.3.1 Solder joint profiles for nickel barrier termination

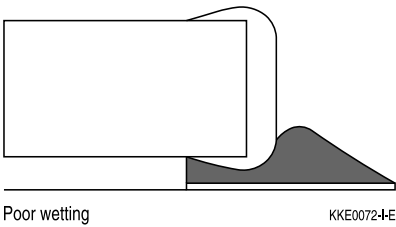
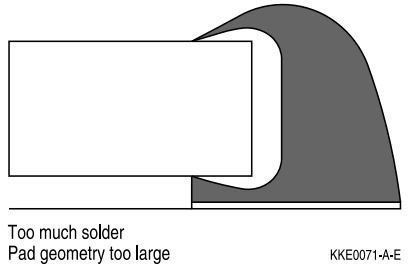
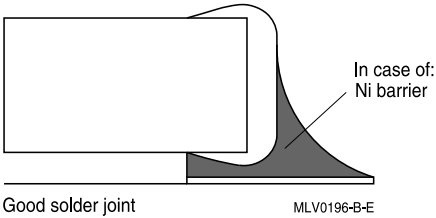

Good and poor solder joints caused by amount of solder in infrared reflow soldering

**SMD**
**4 Solderability tests**

| Test   | Standard       | Test conditions / Sn-Pb soldering  | Test conditions / Pb-free soldering   | Criteria / test results  |
|--|----------------|--|---|--|
| Wettability                                    | IEC 60068-2-58 | Immersion in 60/40 SnPb solder using non-activated flux at $215 \pm 3$ °C for $3 \pm 0.3$ s                      | Immersion in Sn96.5Ag3.0Cu0.5 solder using non- or low activated flux at $245 \pm 5$ °C for $3 \pm 0.3$ s                   | Covering of 95% of end termination, checked by visual inspection |
| Leaching resistance                            | IEC 60068-2-58 | Immersion in 60/40 SnPb solder using mildly activated flux without preheating at $255 \pm 5$ °C for $10 \pm 1$ s | Immersion in Sn96.5Ag3.0Cu0.5 solder using non- or low activated flux without preheating at $255 \pm 5$ °C for $10 \pm 1$ s | No leaching of contacts  |
| Tests of resistance to soldering heat for SMDs | IEC 60068-2-58 | Immersion in 60/40 SnPb for 10 s at 260 °C   | Immersion in Sn96.5Ag3.0Cu0.5 for 10 s at 260 °C  | Capacitance change: $-15\% \leq \Delta C \leq 15\%$              |

**Note:**
**Leaching of the termination**

Effective area at the termination might be lost if the soldering temperature and/or immersion time are not kept within the recommended conditions. Leaching of the outer electrode should not exceed 25% of the chip end area (full length of the edge A-B-C-D) and 25% of the length A-B, shown below as mounted on the substrate.

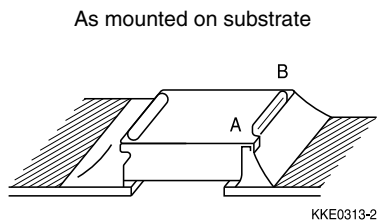
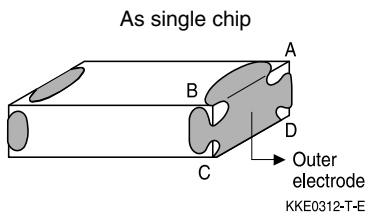

SMD

**5 Notes for proper soldering**

**5.1 Preheating and cooling**

- The average ramp-up rate must not exceed 3 °C/s.
- The cooling rate must not exceed 8 °C/s.

**5.2 Repair / rework**

Manual soldering with a soldering iron must be avoided, hot-air methods are recommended for making repairs.

**5.3 Cleaning**

All environmentally compatible agents are suitable for cleaning. Select the appropriate cleaning solution according to the type of flux used. The temperature difference between the components and cleaning liquid must not be greater than 100 °C. Ultrasonic cleaning should be carried out with the utmost caution. Too high ultrasonic power can impair the adhesive strength of the metalized surfaces. Insufficient or excessive cleaning can be detrimental to CeraDiode performance.

**5.4 Solder paste printing (reflow soldering)**

An excessive application of solder paste results in too high a solder fillet, thus making the chip more susceptible to mechanical and thermal stress. This will lead to the formation of cracks. Too little solder paste reduces the adhesive strength on the outer electrodes and thus weakens the bonding to the PCB. The solder should be applied smoothly to the end surface to a height of min. 0.2 mm.

**5.5 Selection of flux**

Used flux should have less than or equal to 0.1 wt % of halogenated content, since flux residue after soldering could lead to corrosion of the termination and/or increased leakage current on the surface of the CeraDiode. Strong acidic flux must not be used. The amount of flux applied should be carefully controlled, since an excess may generate flux gas, which in turn is detrimental to solderability.

**5.6 Storage**

Solderability is guaranteed for one year from date of delivery, provided that components are stored in their original packages.

Storage temperature:        –25 °C to +45 °C

Relative humidity:         ≤75% annual average, ≤95% on 30 days a year

The solderability of the external electrodes may deteriorate if SMDs are stored where they are exposed to high humidity, dust or harmful gas (hydrogen chloride, sulfurous acid gas or hydrogen sulfide).

Do not store SMDs where they are exposed to heat or direct sunlight. Otherwise the packing material may be deformed or SMDs may stick together, causing problems during mounting.

After opening the factory seals, such as polyvinyl-sealed packages, it is recommended to use the SMDs as soon as possible.



SMD

### 5.7 Placement of components on circuit board

It is of advantage to place the components on the board before soldering so that their two terminals do not enter the solder oven at different times. Ideally, both terminals should be wetted simultaneously.

### 5.8 Soldering caution

- Sudden heating or cooling of the component results in thermal destruction by cracks.
- An excessively long soldering time or high soldering temperature results in leaching of the outer electrodes, causing poor adhesion due to loss of contact between electrodes and termination.
- Avoid manual soldering with a soldering iron.
- Wave soldering must not be applied for CeraDiodes designated for reflow soldering only.
- Keep to the recommended down-cooling rate.

### 5.9 Standards

CECC 00802

IEC 60068-2-58

IEC 60068-2-20

JEDEC J-STD-020D

**CeraDiodes**
**High-speed series**
**SMD**
**Symbols and terms**

| <b>CeraDiode</b>  | <b>Semiconductor diode</b>        |   |
|-------------------|-----------------------------------|---|
| $C_{max}$         |                                   | Maximum capacitance   |
| $C_{typ}$         |                                   | Typical capacitance   |
| $I_{BR}$          | $I_R, I_T$                        | (Reverse) current @ breakdown voltage   |
| $I_{leak}$        | $I_{RM}$                          | (Reverse) leakage current   |
| $I_{PP}$          | $I_{PP}$                          | Current @ clamping voltage  |
| $I_{PP}$          | $I_P, I_{PP}$                     | Peak pulse current  |
| $P_{PP}$          | $P_{PP}$                          | Peak pulse power  |
| $T_{op}$          |                                   | Operating temperature   |
| $T_{stg}$         |                                   | Storage temperature   |
| $V_{BR}$          | $V_{BR}$                          | (Reverse) breakdown voltage   |
| $V_{BR,min}$      |                                   | Minimum breakdown voltage   |
| $V_{clamp}$       | $V_{cl}, V_C$                     | Clamping voltage  |
| $V_{clamp,max}$   |                                   | Maximum clamping voltage  |
| $V_{DC}$          | $V_{RM}, V_{RWM}, V_{WM}, V_{DC}$ | (Reverse) stand-off voltage, working voltage, operating voltage                           |
| $V_{DC,max}$      |                                   | Maximum DC operating voltage  |
| $V_{ESD,air}$     |                                   | Air discharge ESD capability  |
| $V_{ESD,contact}$ |                                   | Contact discharge ESD capability  |
| $V_{leak}$        | $V_{RM}, V_{RWM}, V_{WM}, V_{DC}$ | (Reverse) voltage @ leakage current   |
| - *)              | $I_F$                             | Current @ forward voltage   |
| - *)              | $I_{RM}, I_{RM,max}@V_{RM}$       | (Reverse) current @ maximum reverse stand-off voltage, working voltage, operating voltage |
| - *)              | $V_F$                             | Forward voltage   |

\*) Not applicable due to bidirectional characteristics of CeraDiodes

## Cautions and warnings

### General

Some parts of this publication contain statements about the suitability of our CeraDiodes for certain areas of application, including recommendations about incorporation/design-in of these products into customer applications. The statements are based on our knowledge of typical requirements often made of our CeraDiodes in the particular areas. We nevertheless expressly point out that such statements cannot be regarded as binding statements about the suitability of our CeraDiodes for a particular customer application. As a rule, EPCOS is either unfamiliar with individual customer applications or less familiar with them than the customers themselves. For these reasons, it is always incumbent on the customer to check and decide whether the CeraDiodes with the properties described in the product specification are suitable for use in a particular customer application.

- Do not use EPCOS CeraDiodes for purposes not identified in our specifications, application notes and data books.
- Ensure the suitability of a CeraDiode in particular by testing it for reliability during design-in. Always evaluate a CeraDiode under worst-case conditions.
- Pay special attention to the reliability of CeraDiodes intended for use in safety-critical applications (e.g. medical equipment, automotive, spacecraft, nuclear power plant).

### Design notes

- Always connect a CeraDiode in parallel with the electronic circuit to be protected.
- Consider maximum rated power dissipation if a CeraDiode has insufficient time to cool down between a number of pulses occurring within a specified isolated time period. Ensure that electrical characteristics do not degrade.
- Consider derating at higher operating temperatures. Choose the highest voltage class compatible with derating at higher temperatures.
- Surge currents beyond specified values will puncture a CeraDiode. In extreme cases a CeraDiode will burst.
- If steep surge current edges are to be expected, make sure your design is as low-inductance as possible.
- In some cases the malfunctioning of passive electronic components or failure before the end of their service life cannot be completely ruled out in the current state of the art, even if they are operated as specified. Do not use CeraDiodes in applications requiring a very high level of operational safety and especially when the malfunction or failure of a passive electronic component could endanger human life or health (e.g. in accident prevention, life-saving systems, or automotive battery line applications such as clamp 30), ensure by suitable design of the application or other measures (e.g. installation of protective circuitry or redundancy) that no injury or damage is sustained by third parties in the event of such a malfunction or failure.
- Specified values only apply to CeraDiodes that have not been subject to prior electrical, mechanical or thermal damage. The use of CeraDiodes in line-to-ground applications is therefore not advisable, and it is only allowed together with safety countermeasures like thermal fuses.

SMD

### Storage

- Only store CeraDiodes in their original packaging. Do not open the package before storage.
- Storage conditions in original packaging: temperature -25 to +45°C, relative humidity ≤75% annual average, maximum 95%, dew precipitation is inadmissible.
- Do not store CeraDiodes where they are exposed to heat or direct sunlight. Otherwise the packaging material may be deformed or CeraDiodes may stick together, causing problems during mounting.
- Avoid contamination of the CeraDiode surface during storage, handling and processing.
- Avoid storing CeraDiodes in harmful environments where they are exposed to corrosive gases for example (SO<sub>x</sub>, Cl).
- Use CeraDiodes as soon as possible after opening factory seals such as polyvinyl-sealed packages.
- Solder CeraDiodes after shipment from EPCOS within the time specified: 12 months.

### Handling

- Do not drop CeraDiodes and allow them to be chipped.
- Do not touch CeraDiodes with your bare hands - gloves are recommended.
- Avoid contamination of the CeraDiode surface during handling.
- Washing processes may damage the product due to the possible static or cyclic mechanical loads (e.g. ultrasonic cleaning). They may cause cracks to develop on the product and its parts, which might lead to reduced reliability or lifetime.

### Mounting

- When CeraDiodes are encapsulated with sealing material or overmolded with plastic material, be aware that potting, sealing or adhesive compounds can produce chemical reactions in the CeraDiode ceramic that will degrade its electrical characteristics and reduce its lifetime.
- Make sure an electrode is not scratched before, during or after the mounting process.
- Make sure contacts and housings used for assembly with CeraDiodes are clean before mounting.
- The surface temperature of an operating CeraDiode can be higher. Ensure that adjacent components are placed at a sufficient distance from a CeraDiode to allow proper cooling.
- Avoid contamination of the CeraDiode surface during processing.
- Only CeraDiodes with an Ni barrier termination are approved for lead-free soldering.

### Soldering

- Complete removal of flux is recommended to avoid surface contamination that can result in an instable and/or high leakage current.
- Use resin-type or non-activated flux.
- Bear in mind that insufficient preheating may cause ceramic cracks.
- Rapid cooling by dipping in solvent is not recommended, otherwise a component may crack.

SMD

**Operation**

- Use CeraDiodes only within the specified operating temperature range.
- Use CeraDiodes only within specified voltage and current ranges.
- Environmental conditions must not harm a CeraDiode. Only use them in normal atmospheric conditions. Reducing the atmosphere (e.g. hydrogen or nitrogen atmosphere) is prohibited.
- Prevent a CeraDiode from contacting liquids and solvents. Make sure that no water enters a CeraDiode (e.g. through plug terminals).
- Avoid dewing and condensation.
- EPCOS CeraDiodes are designed for encased applications. Under all circumstances avoid exposure to:
  - direct sunlight
  - rain or condensation
  - steam, saline spray
  - corrosive gases
  - atmosphere with reduced oxygen content
- EPCOS CeraDiodes are not suitable for switching applications or voltage stabilization where static power dissipation is required.
- CeraDiodes are designed for ESD protection only.

This listing does not claim to be complete, it merely reflects the experience of EPCOS AG.

## Important notes

The following applies to all products named in this publication:

1. Some parts of this publication contain **statements about the suitability of our products for certain areas of application**. These statements are based on our knowledge of typical requirements that are often placed on our products in the areas of application concerned. We nevertheless expressly point out **that such statements cannot be regarded as binding statements about the suitability of our products for a particular customer application**. As a rule, EPCOS is either unfamiliar with individual customer applications or less familiar with them than the customers themselves. For these reasons, it is always ultimately incumbent on the customer to check and decide whether an EPCOS product with the properties described in the product specification is suitable for use in a particular customer application.
2. We also point out that **in individual cases, a malfunction of electronic components or failure before the end of their usual service life cannot be completely ruled out in the current state of the art, even if they are operated as specified**. In customer applications requiring a very high level of operational safety and especially in customer applications in which the malfunction or failure of an electronic component could endanger human life or health (e.g. in accident prevention or lifesaving systems), it must therefore be ensured by means of suitable design of the customer application or other action taken by the customer (e.g. installation of protective circuitry or redundancy) that no injury or damage is sustained by third parties in the event of malfunction or failure of an electronic component.
3. **The warnings, cautions and product-specific notes must be observed.**
4. In order to satisfy certain technical requirements, **some of the products described in this publication may contain substances subject to restrictions in certain jurisdictions (e.g. because they are classed as hazardous)**. Useful information on this will be found in our Material Data Sheets on the Internet ([www.epcos.com/material](http://www.epcos.com/material)). Should you have any more detailed questions, please contact our sales offices.
5. We constantly strive to improve our products. Consequently, **the products described in this publication may change from time to time**. The same is true of the corresponding product specifications. Please check therefore to what extent product descriptions and specifications contained in this publication are still applicable before or when you place an order. We also **reserve the right to discontinue production and delivery of products**. Consequently, we cannot guarantee that all products named in this publication will always be available. The aforementioned does not apply in the case of individual agreements deviating from the foregoing for customer-specific products.
6. Unless otherwise agreed in individual contracts, **all orders are subject to the current version of the "General Terms of Delivery for Products and Services in the Electrical Industry" published by the German Electrical and Electronics Industry Association (ZVEI)**.
7. The trade names EPCOS, BAOKE, Alu-X, CeraDiode, CeraLink, CSMP, CSSP, CTVS, DeltaCap, DigiSiMic, DSSP, FilterCap, FormFit, MiniBlue, MiniCell, MKD, MKK, MLSC, MotorCap, PCC, PhaseCap, PhaseCube, PhaseMod, PhiCap, SIFERRIT, SIFI, SIKOREL, SilverCap, SIMDAD, SiMic, SIMID, SineFormer, SIOV, SIP5D, SIP5K, ThermoFuse, WindCap are **trademarks registered or pending** in Europe and in other countries. Further information will be found on the Internet at [www.epcos.com/trademarks](http://www.epcos.com/trademarks).

# Mouser Electronics

Authorized Distributor

Click to View Pricing, Inventory, Delivery & Lifecycle Information:

## EPCOS:

[B72590D150H60](#) [B72590D50H160](#) [B72500D160H60](#) [B72500D300H60](#) [B72570D120A60](#) [B72570D160H60](#)  
[B72590D160H60](#) [B72714D160H60](#) [B72724D160H62](#) [B72735D50H62](#) [B72500D0050H160](#) [B72735D0050H062](#)  
[B72440C50H260](#) [B72590D200H60](#) [B72590D50H260](#) [B72440C50H160](#) [B72590D120H60](#) [B72440D50H60](#)  
[B72500D50H160](#) [B72755D50H62](#)

Компания «Life Electronics» занимается поставками электронных компонентов импортного и отечественного производства от производителей и со складов крупных дистрибьюторов Европы, Америки и Азии.

С конца 2013 года компания активно расширяет линейку поставок компонентов по направлению коаксиальный кабель, кварцевые генераторы и конденсаторы (керамические, пленочные, электролитические), за счёт заключения дистрибьюторских договоров

Мы предлагаем:

- Конкурентоспособные цены и скидки постоянным клиентам.
- Специальные условия для постоянных клиентов.
- Подбор аналогов.
- Поставку компонентов в любых объемах, удовлетворяющих вашим потребностям.
- Приемлемые сроки поставки, возможна ускоренная поставка.
- Доставку товара в любую точку России и стран СНГ.
- Комплексную поставку.
- Работу по проектам и поставку образцов.
- Формирование склада под заказчика.
- Сертификаты соответствия на поставляемую продукцию (по желанию клиента).
- Тестирование поставляемой продукции.
- Поставку компонентов, требующих военную и космическую приемку.
- Входной контроль качества.
- Наличие сертификата ISO.

В составе нашей компании организован Конструкторский отдел, призванный помогать разработчикам, и инженерам.

Конструкторский отдел помогает осуществить:

- Регистрацию проекта у производителя компонентов.
- Техническую поддержку проекта.
- Защиту от снятия компонента с производства.
- Оценку стоимости проекта по компонентам.
- Изготовление тестовой платы монтаж и пусконаладочные работы.



Тел: +7 (812) 336 43 04 (многоканальный)

Email: [org@lifeelectronics.ru](mailto:org@lifeelectronics.ru)