

74FST3257

Quad 2:1 Multiplexer/ Demultiplexer Bus Switch

The ON Semiconductor 74FST3257 is a quad 2:1, high performance multiplexer/demultiplexer bus switch. The device is CMOS TTL compatible when operating between 4 and 5.5 Volts. The device exhibits extremely low R_{ON} and adds nearly zero propagation delay. The device adds no noise or ground bounce to the system.

Features

- $R_{ON} < 4 \Omega$ Typical
- Less Than 0.25 ns–Max Delay Through Switch
- Nearly Zero Standby Current
- No Circuit Bounce
- Control Inputs are TTL/CMOS Compatible
- Pin-For-Pin Compatible With QS3257, FST3257, CBT3257
- All Popular Packages: SOIC-16, TSSOP-16, QFN16
- These Devices are Pb-Free and are RoHS Compliant

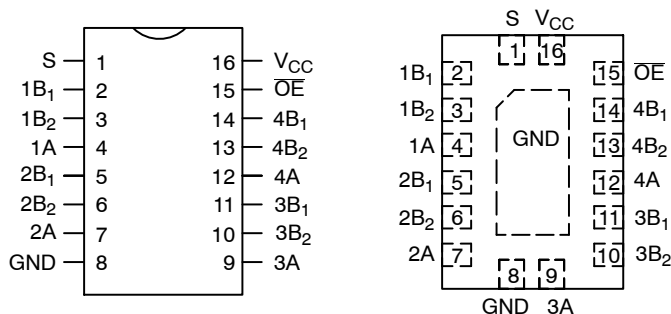

Figure 1. 16-Lead Pinout Diagrams

| S | OE | Function |
|---|----|--------------------|
| X | H | Disconnect |
| L | L | A = B ₁ |
| H | L | A = B ₂ |

Figure 2. Truth Table



ON Semiconductor®

<http://onsemi.com>

MARKING DIAGRAMS

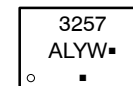
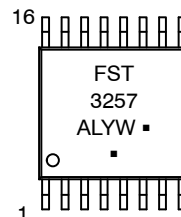
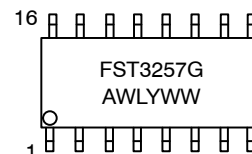

A = Assembly Location
WL, L = Wafer Lot
Y = Year
WW, W = Work Week
G or ■ = Pb-Free Package

(Note: Microdot may be in either location)

PIN NAMES

| Pin | Description |
|---|--------------------|
| OE ₁ , OE ₂ | Bus Switch Enables |
| S ₀ , S ₁ | Select Inputs |
| A | Bus A |
| B ₁ , B ₂ , B ₃ , B ₄ | Bus B |

ORDERING INFORMATION

See detailed ordering and shipping information in the package dimensions section on page 2 of this data sheet.

74FST3257

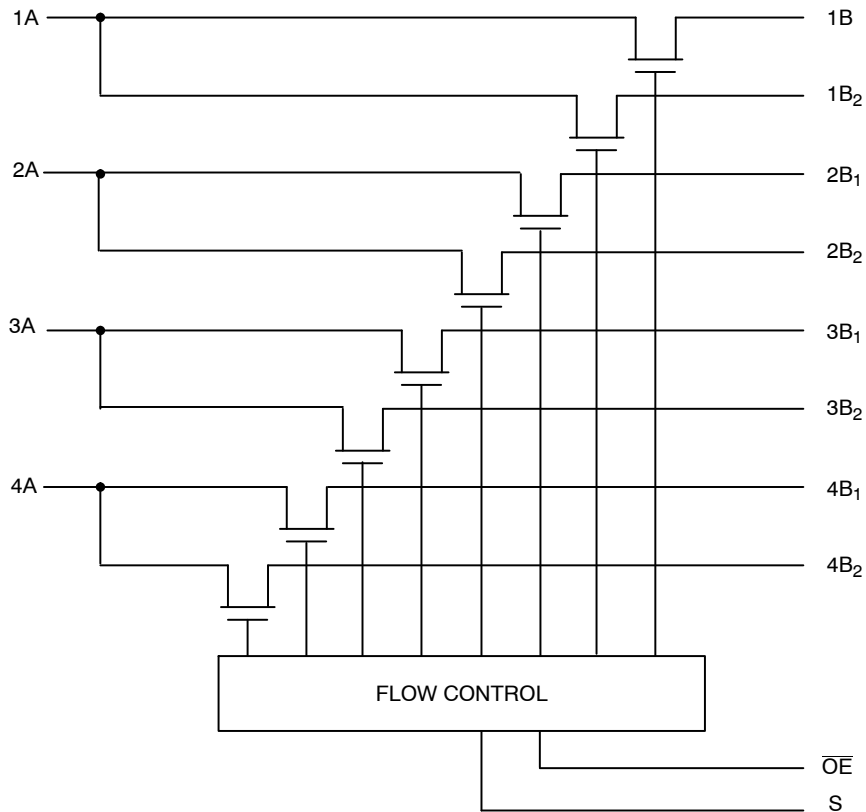

Figure 3. Logic Diagram

ORDERING INFORMATION

| Device Order Number | Package | Shipping [†] |
|---------------------|------------------------|--------------------------|
| 74FST3257DR2G | SOIC-16 (Pb-Free) | 2500 Units / Tape & Reel |
| 74FST3257DTR2G | TSSOP-16* (Pb-Free) | 2500 Units / Tape & Reel |
| 74FST3257MNTWG | QFN16 (Pb-Free) | 3000 Units / Tape & Reel |

[†]For information on tape and reel specifications, including part orientation and tape sizes, please refer to our Tape and Reel Packaging Specifications Brochure, BRD8011/D.

*This package is inherently Pb-Free.

MAXIMUM RATINGS

| Symbol | Parameter | Value | Units |
|---------------|---|------------------------|---------------|
| V_{CC} | DC Supply Voltage | -0.5 to +7.0 | V |
| V_I | DC Input Voltage | -0.5 to +7.0 | V |
| V_O | DC Output Voltage | -0.5 to +7.0 | V |
| I_{IK} | DC Input Diode Current $V_I < GND$ | -50 | mA |
| I_{OK} | DC Output Diode Current $V_O < GND$ | -50 | mA |
| I_O | DC Output Sink Current | 128 | mA |
| I_{CC} | DC Supply Current per Supply Pin | ± 100 | mA |
| I_{GND} | DC Ground Current per Ground Pin | ± 100 | mA |
| T_{STG} | Storage Temperature Range | -65 to +150 | $^{\circ}C$ |
| T_L | Lead Temperature, 1 mm from Case for 10 Seconds | 260 | $^{\circ}C$ |
| T_J | Junction Temperature Under Bias | +150 | $^{\circ}C$ |
| θ_{JA} | Thermal Resistance SOIC TSSOP QFN | 125 170 N/A | $^{\circ}C/W$ |
| MSL | Moisture Sensitivity | Level 1 | |
| F_R | Flammability Rating Oxygen Index: 28 to 34 | UL 94 V-0 @ 0.125 in | |
| V_{ESD} | ESD Withstand Voltage Human Body Model (Note 1) Machine Model (Note 2) Charged Device Model (Note 3) | > 2000 > 200 N/A | V |
| $I_{Latchup}$ | Latchup Performance Above V_{CC} and Below GND at 85 $^{\circ}C$ (Note 4) | ± 500 | mA |

Stresses exceeding Maximum Ratings may damage the device. Maximum Ratings are stress ratings only. Functional operation above the Recommended Operating Conditions is not implied. Extended exposure to stresses above the Recommended Operating Conditions may affect device reliability.

1. Tested to EIA/JESD22-A114-A.
2. Tested to EIA/JESD22-A115-A.
3. Tested to JESD22-C101-A.
4. Tested to EIA/JESD78.

RECOMMENDED OPERATING CONDITIONS

| Symbol | Parameter | Min | Max | Units |
|---------------------|--|-----|---------|-------------|
| V_{CC} | Supply Voltage Operating, Data Retention Only | 4.0 | 5.5 | V |
| V_I | Input Voltage (Note 5) | 0 | 5.5 | V |
| V_O | Output Voltage (HIGH or LOW State) | 0 | 5.5 | V |
| T_A | Operating Free-Air Temperature | -40 | +85 | $^{\circ}C$ |
| $\Delta t/\Delta V$ | Input Transition Rise or Fall Rate Switch I/O | 0 | DC 5 | ns/V |
| | Switch Control Input $V_{CC} = 5.0 V \pm 0.5 V$ | | | |

5. Unused control inputs may not be left open. All control inputs must be tied to a high or low logic input voltage level.

74FST3257

DC ELECTRICAL CHARACTERISTICS

| Symbol | Parameter | Conditions | V _{CC} (V) | T _A = -40°C to +85°C | | | Units |
|------------------|---------------------------------------|--|------------------------|---------------------------------|------|------|-------|
| | | | | Min | Typ* | Max | |
| V _{IK} | Clamp Diode Voltage | I _{IN} = -18 mA | 4.5 | | | -1.2 | V |
| V _{IH} | High-Level Input Voltage | | 4.0 to 5.5 | 2.0 | | | V |
| V _{IL} | Low-Level Input Voltage | | 4.0 to 5.5 | | | 0.8 | V |
| I _I | Input Leakage Current | 0 ≤ V _{IN} ≤ 5.5 V | 5.5 | | | ±1.0 | μA |
| I _{OZ} | Off-State Leakage Current | 0 ≤ A, B ≤ V _{CC} | 5.5 | | | ±1.0 | μA |
| R _{ON} | Switch On Resistance (Note 6) | V _{IN} = 0 V, I _{IN} = 64 mA | 4.5 | | 4 | 7 | Ω |
| | | V _{IN} = 0 V, I _{IN} = 30 mA | 4.5 | | 4 | 7 | |
| | | V _{IN} = 2.4 V, I _{IN} = 15 mA | 4.5 | | 8 | 15 | |
| | | V _{IN} = 2.4 V, I _{IN} = 15 mA | 4.0 | | 11 | 20 | |
| I _{CC} | Quiescent Supply Current | V _{IN} = V _{CC} or GND, I _{OUT} = 0 | 5.5 | | | 3 | μA |
| ΔI _{CC} | Increase In I _{CC} per Input | One input at 3.4 V, Other inputs at V _{CC} or GND | 5.5 | | | 2.5 | mA |

*Typical values are at V_{CC} = 5.0 V and T_A = 25°C.

6. Measured by the voltage drop between A and B pins at the indicated current through the switch. On resistance is determined by the lower of the voltages on the two (A or B) pins.

AC ELECTRICAL CHARACTERISTICS

| Symbol | Parameter | Conditions | T _A = -40°C to +85°C C _L = 50 pF, R _U = R _D = 500 Ω | | | | Units |
|--|--|--|--|------|-------------------------|------|-------|
| | | | V _{CC} = 4.5-5.5 V | | V _{CC} = 4.0 V | | |
| | | | Min | Max | Min | Max | |
| t _{PHL} , t _{PLH} | Prop Delay Bus to Bus (Note 7) | V _I = OPEN | | 0.25 | | 0.25 | ns |
| | Prop Delay, Select to Bus A | | 1.0 | 4.7 | | 5.2 | |
| t _{PZH} , t _{PZL} | Output Enable Time, Select to Bus B | V _I = 7 V for t _{PZL} | 1.0 | 5.2 | | 5.7 | ns |
| | Output Enable Time, I _{OE} to Bus A, B | V _I = OPEN for t _{PZH} | 1.0 | 5.1 | | 5.6 | |
| t _{PHZ} , t _{PLZ} | Output Disable Time, Select to Bus B | V _I = 7 V for t _{PLZ} | 1.0 | 5.2 | | 5.5 | ns |
| | Output Disable Time, I _{OE} to Bus A, B | V _I = OPEN for t _{PHZ} | 1.0 | 5.5 | | 5.5 | |

7. This parameter is guaranteed by design but is not tested. The bus switch contributes no propagation delay other than the RC delay of the typical On resistance of the switch and the 50 pF load capacitance, when driven by an ideal voltage source (zero output impedance).

CAPACITANCE (Note 8)

| Symbol | Parameter | Conditions | Typ | Max | Units |
|------------------|---------------------------------|---|-----|-----|-------|
| C _{IN} | Control Pin Input Capacitance | V _{CC} = 5.0 V | 3 | | pF |
| C _{I/O} | A Port Input/Output Capacitance | V _{CC} , \overline{OE} = 5.0 V | 7 | | pF |
| C _{I/O} | B Port Input/Output Capacitance | V _{CC} , \overline{OE} = 5.0 V | 5 | | pF |

8. T_A = +25°C, f = 1 MHz, Capacitance is characterized but not tested.

74FST3257

AC Loading and Waveforms

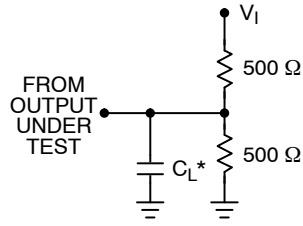

NOTES:

1. Input driven by 50 Ω source terminated in 50 Ω.
 2. CL includes load and stray capacitance.
- *C_L = 50 pF

Figure 4. AC Test Circuit

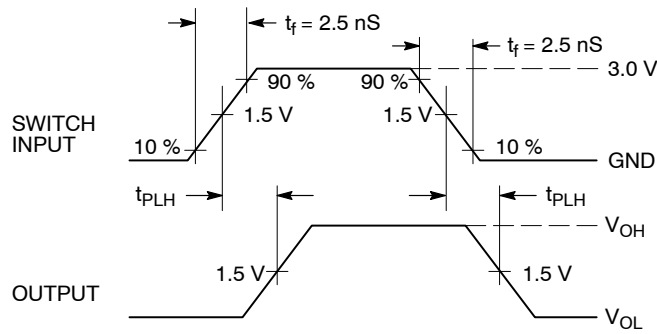

Figure 5. Propagation Delays

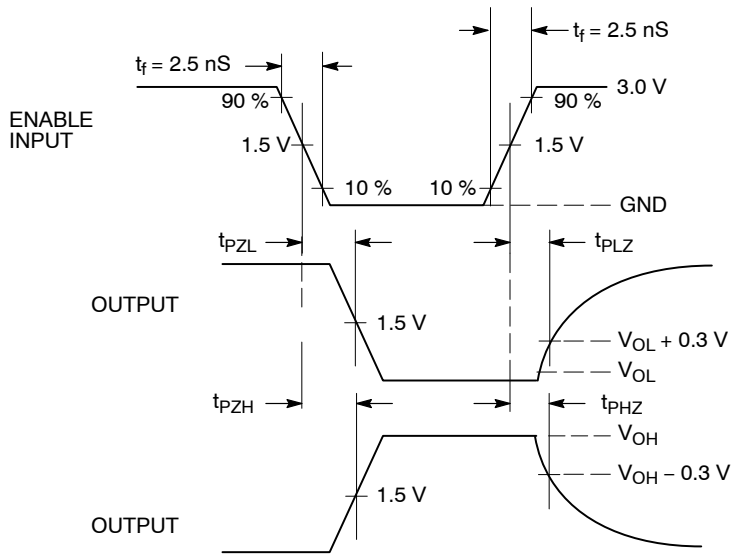
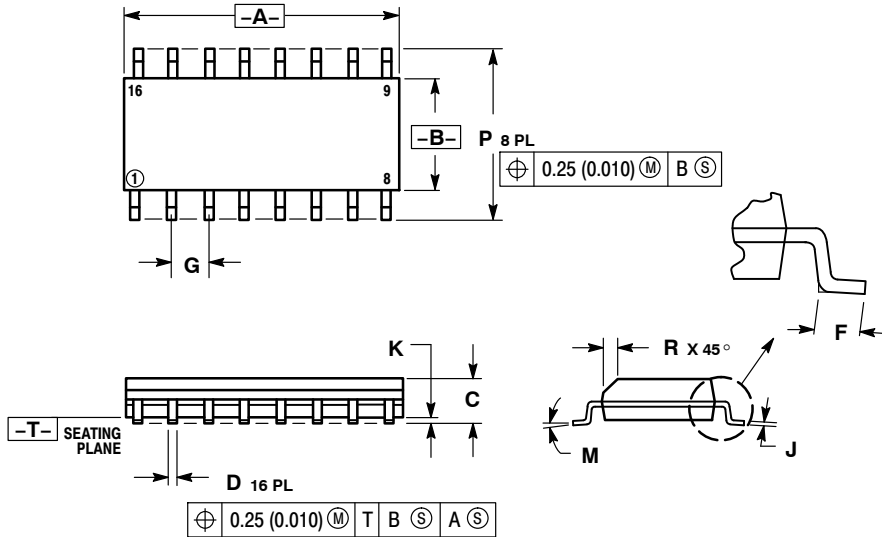

Figure 6. Enable/Disable Delays

74FST3257

PACKAGE DIMENSIONS

SOIC-16
D SUFFIX
CASE 751B-05
ISSUE K



NOTES:

1. DIMENSIONING AND TOLERANCING PER ANSI Y14.5M, 1982.
2. CONTROLLING DIMENSION: MILLIMETER.
3. DIMENSIONS A AND B DO NOT INCLUDE MOLD PROTRUSION.
4. MAXIMUM MOLD PROTRUSION 0.15 (0.006) PER SIDE.
5. DIMENSION D DOES NOT INCLUDE DAMBAR PROTRUSION. ALLOWABLE DAMBAR PROTRUSION SHALL BE 0.127 (0.005) TOTAL IN EXCESS OF THE D DIMENSION AT MAXIMUM MATERIAL CONDITION.

| MILLIMETERS | | INCHES | | |
|-------------|----------|--------|-----------|-------|
| DIM | MIN | MAX | MIN | MAX |
| A | 9.80 | 10.00 | 0.386 | 0.393 |
| B | 3.80 | 4.00 | 0.150 | 0.157 |
| C | 1.35 | 1.75 | 0.054 | 0.068 |
| D | 0.35 | 0.49 | 0.014 | 0.019 |
| F | 0.40 | 1.25 | 0.016 | 0.049 |
| G | 1.27 BSC | | 0.050 BSC | |
| J | 0.19 | 0.25 | 0.008 | 0.009 |
| K | 0.10 | 0.25 | 0.004 | 0.009 |
| M | 0° | 7° | 0° | 7° |
| P | 5.80 | 6.20 | 0.229 | 0.244 |
| R | 0.25 | 0.50 | 0.010 | 0.019 |

SOLDERING FOOTPRINT

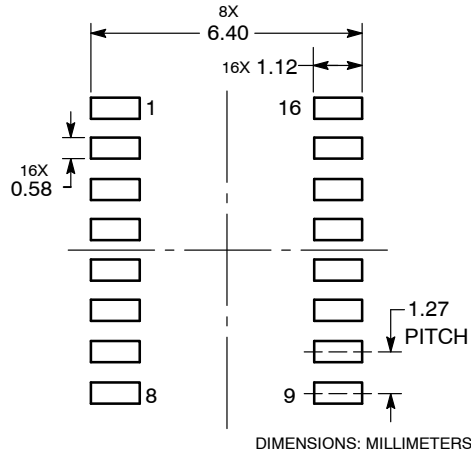

74FST3257

PACKAGE DIMENSIONS

TSSOP-16
DT SUFFIX
CASE 948F-01
ISSUE B

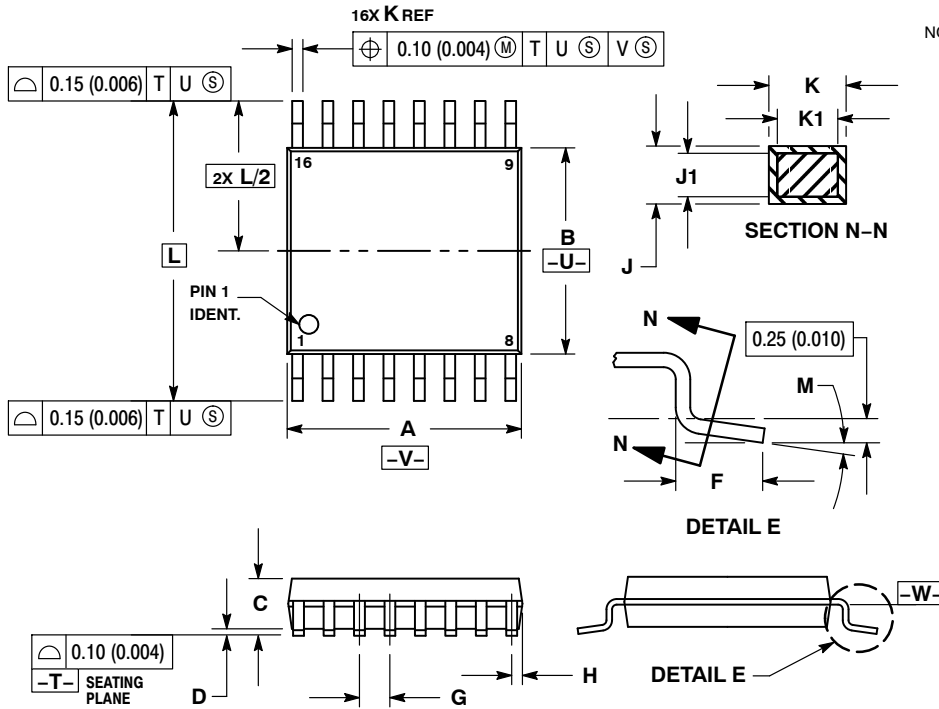

NOTES:

1. DIMENSIONING AND TOLERANCING PER ANSI Y14.5M, 1982.
2. CONTROLLING DIMENSION: MILLIMETER.
3. DIMENSION A DOES NOT INCLUDE MOLD FLASH, PROTRUSIONS OR GATE BURRS. MOLD FLASH OR GATE BURRS SHALL NOT EXCEED 0.15 (0.006) PER SIDE.
4. DIMENSION B DOES NOT INCLUDE INTERLEAD FLASH OR PROTRUSION. INTERLEAD FLASH OR PROTRUSION SHALL NOT EXCEED 0.25 (0.010) PER SIDE.
5. DIMENSION K DOES NOT INCLUDE DAMBAR PROTRUSION. ALLOWABLE DAMBAR PROTRUSION SHALL BE 0.08 (0.003) TOTAL IN EXCESS OF THE K DIMENSION AT MAXIMUM MATERIAL CONDITION.
6. TERMINAL NUMBERS ARE SHOWN FOR REFERENCE ONLY.
7. DIMENSION A AND B ARE TO BE DETERMINED AT DATUM PLANE -W-.

| DIM | MILLIMETERS | | INCHES | |
|-----|-------------|------|-----------|-------|
| | MIN | MAX | MIN | MAX |
| A | 4.90 | 5.10 | 0.193 | 0.200 |
| B | 4.30 | 4.50 | 0.169 | 0.177 |
| C | --- | 1.20 | --- | 0.047 |
| D | 0.05 | 0.15 | 0.002 | 0.006 |
| F | 0.50 | 0.75 | 0.020 | 0.030 |
| G | 0.65 BSC | | 0.026 BSC | |
| H | 0.18 | 0.28 | 0.007 | 0.011 |
| J | 0.09 | 0.20 | 0.004 | 0.008 |
| J1 | 0.09 | 0.16 | 0.004 | 0.006 |
| K | 0.19 | 0.30 | 0.007 | 0.012 |
| K1 | 0.19 | 0.25 | 0.007 | 0.010 |
| L | 6.40 BSC | | 0.252 BSC | |
| M | 0° | 8° | 0° | 8° |

SOLDERING FOOTPRINT

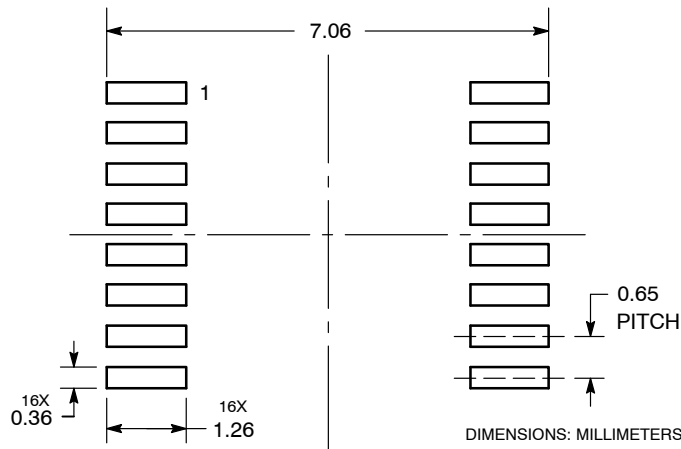

74FST3257

PACKAGE DIMENSIONS

QFN16
MN SUFFIX
 CASE 485AW-01
 ISSUE O

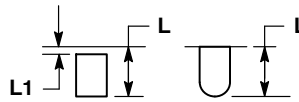
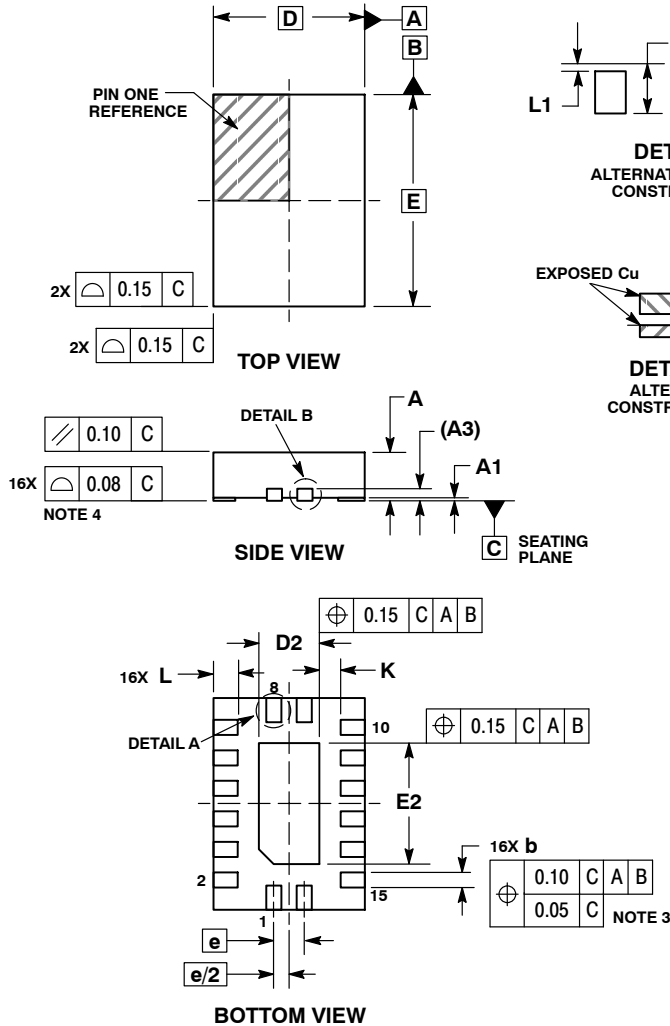

DETAIL A
 ALTERNATE TERMINAL
 CONSTRUCTIONS

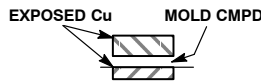

DETAIL B
 ALTERNATE
 CONSTRUCTIONS

NOTES:

1. DIMENSIONING AND TOLERANCING PER ASME Y14.5M, 1994.
2. CONTROLLING DIMENSION: MILLIMETERS.
3. DIMENSIONS b APPLIES TO PLATED TERMINAL AND IS MEASURED BETWEEN 0.15 AND 0.30 MM FROM TERMINAL.
4. COPLANARITY APPLIES TO THE EXPOSED PAD AS WELL AS THE TERMINALS.

| DIM | MILLIMETERS | |
|-----|-------------|------|
| | MIN | MAX |
| A | 0.80 | 1.00 |
| A1 | 0.00 | 0.05 |
| A3 | 0.20 REF | |
| b | 0.20 | 0.30 |
| D | 2.50 BSC | |
| D2 | 0.85 | 1.15 |
| E | 3.50 BSC | |
| E2 | 1.85 | 2.15 |
| e | 0.50 BSC | |
| K | 0.20 | --- |
| L | 0.35 | 0.45 |
| L1 | --- | 0.15 |

SOLDERING FOOTPRINT*

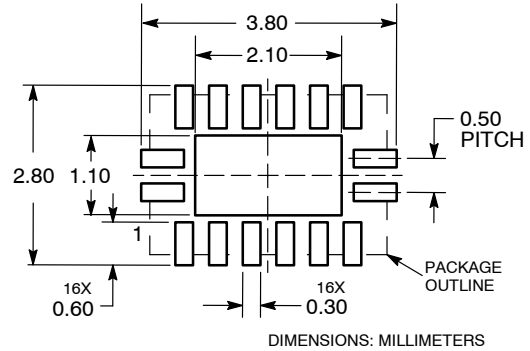

*For additional information on our Pb-Free strategy and soldering details, please download the ON Semiconductor Soldering and Mounting Techniques Reference Manual, SOLDERRM/D.

ON Semiconductor and are registered trademarks of Semiconductor Components Industries, LLC (SCILLC). SCILLC reserves the right to make changes without further notice to any products herein. SCILLC makes no warranty, representation or guarantee regarding the suitability of its products for any particular purpose, nor does SCILLC assume any liability arising out of the application or use of any product or circuit, and specifically disclaims any and all liability, including without limitation special, consequential or incidental damages. "Typical" parameters which may be provided in SCILLC data sheets and/or specifications can and do vary in different applications and actual performance may vary over time. All operating parameters, including "Typicals" must be validated for each customer application by customer's technical experts. SCILLC does not convey any license under its patent rights nor the rights of others. SCILLC products are not designed, intended, or authorized for use as components in systems intended for surgical implant into the body, or other applications intended to support or sustain life, or for any other application in which the failure of the SCILLC product could create a situation where personal injury or death may occur. Should Buyer purchase or use SCILLC products for any such unintended or unauthorized application, Buyer shall indemnify and hold SCILLC and its officers, employees, subsidiaries, affiliates, and distributors harmless against all claims, costs, damages, and expenses, and reasonable attorney fees arising out of, directly or indirectly, any claim of personal injury or death associated with such unintended or unauthorized use, even if such claim alleges that SCILLC was negligent regarding the design or manufacture of the part. SCILLC is an Equal Opportunity/Affirmative Action Employer. This literature is subject to all applicable copyright laws and is not for resale in any manner.

PUBLICATION ORDERING INFORMATION

LITERATURE FULFILLMENT:
 Literature Distribution Center for ON Semiconductor
 P.O. Box 5163, Denver, Colorado 80217 USA
Phone: 303-675-2175 or 800-344-3860 Toll Free USA/Canada
Fax: 303-675-2176 or 800-344-3867 Toll Free USA/Canada
Email: orderlit@onsemi.com

N. American Technical Support: 800-282-9855 Toll Free
 USA/Canada
Europe, Middle East and Africa Technical Support:
 Phone: 421 33 790 2910
Japan Customer Focus Center
 Phone: 81-3-5773-3850

ON Semiconductor Website: www.onsemi.com
Order Literature: <http://www.onsemi.com/orderlit>
 For additional information, please contact your local Sales Representative

Компания «Life Electronics» занимается поставками электронных компонентов импортного и отечественного производства от производителей и со складов крупных дистрибьюторов Европы, Америки и Азии.

С конца 2013 года компания активно расширяет линейку поставок компонентов по направлению коаксиальный кабель, кварцевые генераторы и конденсаторы (керамические, пленочные, электролитические), за счёт заключения дистрибьюторских договоров

Мы предлагаем:

- Конкурентоспособные цены и скидки постоянным клиентам.
- Специальные условия для постоянных клиентов.
- Подбор аналогов.
- Поставку компонентов в любых объемах, удовлетворяющих вашим потребностям.
- Приемлемые сроки поставки, возможна ускоренная поставка.
- Доставку товара в любую точку России и стран СНГ.
- Комплексную поставку.
- Работу по проектам и поставку образцов.
- Формирование склада под заказчика.
- Сертификаты соответствия на поставляемую продукцию (по желанию клиента).
- Тестирование поставляемой продукции.
- Поставку компонентов, требующих военную и космическую приемку.
- Входной контроль качества.
- Наличие сертификата ISO.

В составе нашей компании организован Конструкторский отдел, призванный помогать разработчикам, и инженерам.

Конструкторский отдел помогает осуществить:

- Регистрацию проекта у производителя компонентов.
- Техническую поддержку проекта.
- Защиту от снятия компонента с производства.
- Оценку стоимости проекта по компонентам.
- Изготовление тестовой платы монтаж и пусконаладочные работы.



Тел: +7 (812) 336 43 04 (многоканальный)
Email: org@lifeelectronics.ru