

Solid State Relay G3MC

Compact, Thin-profile, Low-cost SSR with Reinforced Insulation

- Small bottom surface area (approx. 80% of the conventional G3MB's), ideal for close PCB mounting.
- DC input and AC output for an applicable load of 1A at 40°C.
- Compact, thin-profile SSR of monoblock construction with an all-in-one frame incorporates a PCB, terminals, and a heatsink.
- Approved by UL and CSA. VDE certified models available.
- Models with reinforced insulation are available.

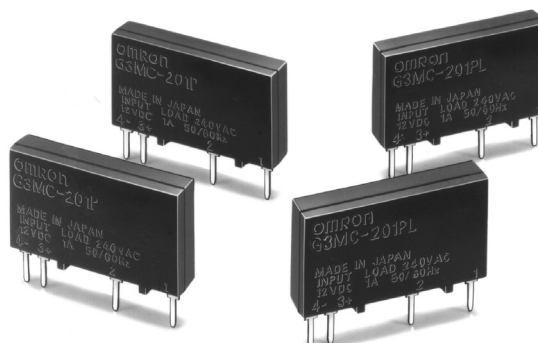

Ordering Information

To Order: Select the part number and add the desired coil voltage rating, (e.g., G3MC-101P-DC12).

Isolation	Zero-cross function	Built-in snubber circuit	Rated output load	Rated input voltage	Part number
Phototriac	Yes	Yes	1 A at 100 to 120 VAC (75 to 132 VAC)	5 VDC	G3MC-101P
				12 VDC	
				24 VDC	
	No			5 VDC	G3MC-101PL
				12 VDC	
				24 VDC	
	Yes		2 A at 100 to 240 VAC (75 to 264 VAC)	5 VDC	G3MC-202P
				12 VDC	
24 VDC					
No		5 VDC		G3MC-202PL	
	12 VDC				
	24 VDC				

Note: 1. All models meet UL and CSA standards. In order to obtain VDE approved versions with UL, CSA and VDE Logos, add “-VD” to the part number. Example: G3MC-101P-VD-DC12

2. 2A models are available with reinforced insulation. Add “-1” to the part number to obtain 2A models with reinforced insulation. Examples: G3MC-202PL-1-DC5 G3MC-202P-VD-1-DC24

Specifications

■ Ratings (Ambient temperature 25°C)

Input

Rated voltage	Operating voltage	Impedance	Voltage levels	
			Must operate voltage	Must dropout voltage
5 VDC	4 to 6 VDC	300Ω ±20%	4 VDC max.	1 VDC min.
12 VDC	9.6 to 14.4 VDC	800Ω ±20%	9.6 VDC max.	
24 VDC	19.2 to 28.8 VDC	1.6kΩ ±20%	19.2 VDC max.	

Note: Each model has 5-VDC, 12-VDC, and 24-VDC input versions.

Output

Part number	Applicable load			
	Rated load voltage	Load voltage range	Load current	Surge current
G3MC-101P(L)(-VD)	100 to 120 VAC, 50/60 Hz	75 to 132 VAC, 50/60 Hz	0.1 to 1 A	8 A (60 Hz, 1 cycle)
G3MC-202P(L)(-VD)(-1)	100 to 240 VAC, 50/60 Hz	75 to 264 VAC, 50/60 Hz	0.1 to 2 A	30 A (60 Hz, 1 cycle)

■ Characteristics

Item	G3MC-101P(-VD)	G3MC-101PL(-VD)	G3MC-202P(-VD)(-1)	G3MC-202PL(-VD)(-1)
Operate time	1/2 of load power source cycle + 1 ms	1 ms max.	1/2 of load power source cycle + 1 ms	1 ms max.
Release time	1/2 of load power source cycle + 1 ms)			
Output ON voltage drop	1.6 V (RMS) max.			
Leakage current	1 mA max. (at 100 VAC)		1.5 mA max. (at 200 VAC)	
Insulation resistance	1,000 MΩ min. (at 500 VDC)			
Dielectric strength	2,500 VAC, 50/60 Hz for 1 min (3,000 VAC, 50/60 Hz for 1 min. for G3MC-□□□-VD-1)			
Vibration resistance	Malfunction: 10 to 55 Hz, 0.75-mm double amplitude			
Shock resistance	Malfunction: 1,000 m/s ² (approx. 100G)			
Ambient temperature	Operating: -30°C to 80°C (with no icing or condensation) Storage: -30°C to 100°C (with no icing or condensation)			
Approved standards	UL File No. E64562, CSA File No. LR35535 EN60950 File No. 5925UG ("VD(-1)" type)			
Ambient humidity	Operating: 45% to 85%			
Weight	Approx. 2.5g (Approx. 5g for G3MC-202P(L)-VD-1)			

Engineering Data

■ G3MC-101P(L)(-VD)

Load Current vs. Ambient Temperature Characteristics

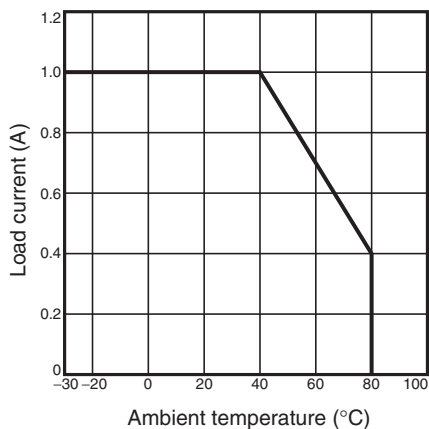

Inrush Current Resistivity

One cycle, non-repetitive (Keep the inrush current to half the rated value if it occurs repeatedly.)

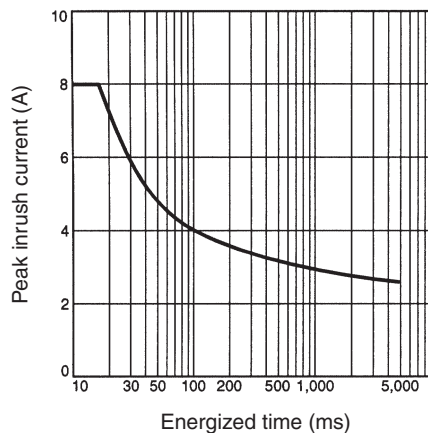

■ G3MC-202P(L)(-VD)(-1)

Load Current vs. Ambient Temperature Characteristics

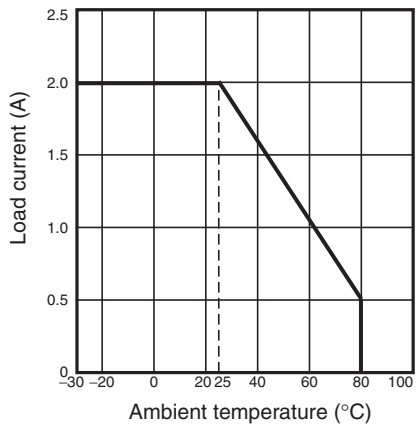

Inrush Current Resistivity

One cycle, non-repetitive (Keep the inrush current to half the rated value if it occurs repeatedly.)

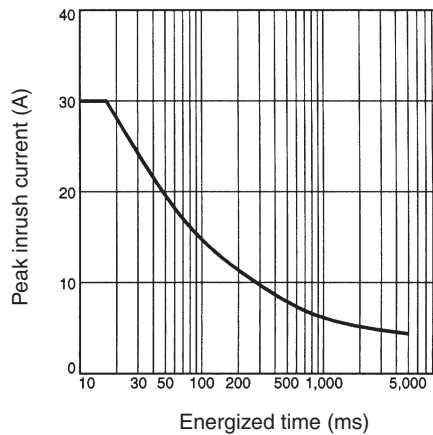

Dimensions

Units: mm (inch)

G3MC-101P(L)(-VD)

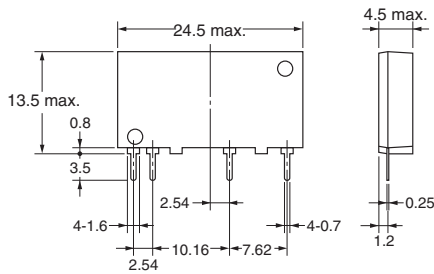
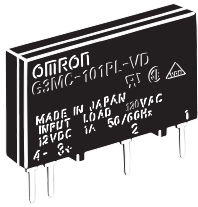

PCB Dimensions (Bottom View)

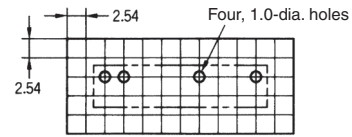

Terminal Arrangement (Bottom View)

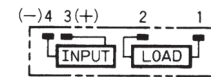

G3MC-202P(L)(-VD)(-1)

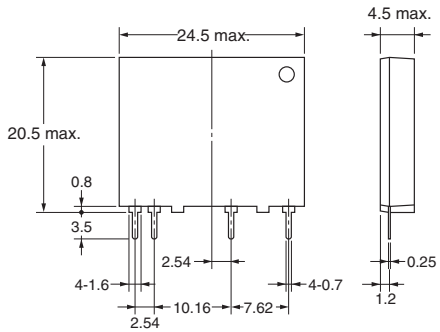
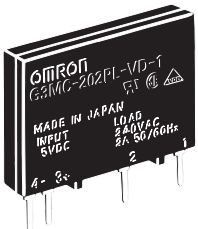

PCB Dimensions (Bottom View)

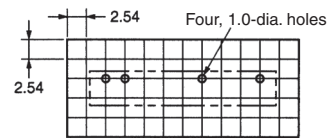

Terminal Arrangement (Bottom View)

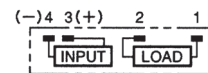

Precautions

General Precautions

Do not touch the terminals of the SSR while power is being supplied to the SSR. The terminals are charged with the power, and an electric shock may be received by touching the terminals.

The built-in capacitor may have a residual voltage after the SSR is turned off. Be sure to discharge the residual voltage before touching the terminals of the SSR, otherwise an electric shock may be received.

Mounting

1. Make sure that no excessive voltage or current is imposed on or flows to the input or output circuit of the SSR, otherwise the SSR may malfunction or burn.
2. Solder the terminals of the SSR properly under the required soldering conditions. The SSR may be abnormally heated and burn if power is supplied to the terminals soldered incorrectly.
3. Do not short-circuit the load of the SSR while power is supplied to the SSR. Do not short-circuit the power supply through the SSR. The SSR may be damaged, malfunction, or burn if the load or power supply is short-circuited.

Correct use

The terminals of the SSR are highly heat-conductive. Each terminal must be soldered within 10 s at 260°C or within 5 s at 350°C.

The SSR is of a thin-profile construction. To maintain the vibration resistance of the SSR, make sure that the space between the SSR and PCB is 0.1 mm maximum. Lifting of the PCB can be prevented by setting the hole diameter of the PCBs on both sides slightly smaller than the actual terminal dimension.

Select the model without the zero-cross function when using the Unit for phase control output.

The casing works as a heat sink. When mounting two or more Units closely, make sure that the Units are properly ventilated by taking ambient temperature rises into consideration. If Units are closely mounted and used in places with no ventilation, the load current of each Unit must be 1/2 of the rated load current.

Protective element

No overvoltage absorption element is built in. Therefore, if the G3MC is connected to an inductive load, be sure to connect the overvoltage absorption element.

G3MC-□□□PL (without Zero cross function)

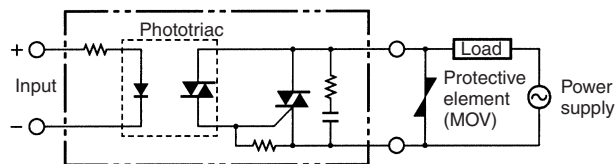

G3MC-□□□P (with Zero cross function)

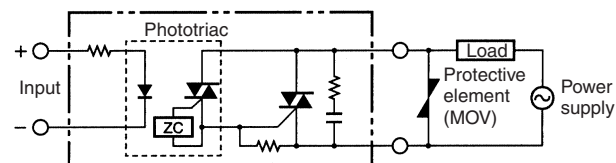

ALL DIMENSIONS SHOWN ARE IN MILLIMETERS.

To convert millimeters into inches, multiply by 0.03937. To convert grams into ounces, multiply by 0.03527.

MEMO

A large grid of dashed lines for taking notes, consisting of 20 columns and 30 rows of small squares.

Read and Understand This Catalog

Please read and understand this catalog before purchasing the products. Please consult your OMRON representative if you have any questions or comments.

Warranty and Limitations of Liability

WARRANTY

OMRON's exclusive warranty is that the products are free from defects in materials and workmanship for a period of one year (or other period if specified) from date of sale by OMRON.

OMRON MAKES NO WARRANTY OR REPRESENTATION, EXPRESS OR IMPLIED, REGARDING NON-INFRINGEMENT, MERCHANTABILITY, OR FITNESS FOR PARTICULAR PURPOSE OF THE PRODUCTS. ANY BUYER OR USER ACKNOWLEDGES THAT THE BUYER OR USER ALONE HAS DETERMINED THAT THE PRODUCTS WILL SUITABLY MEET THE REQUIREMENTS OF THEIR INTENDED USE. OMRON DISCLAIMS ALL OTHER WARRANTIES, EXPRESS OR IMPLIED.

LIMITATIONS OF LIABILITY

OMRON SHALL NOT BE RESPONSIBLE FOR SPECIAL, INDIRECT, OR CONSEQUENTIAL DAMAGES, LOSS OF PROFITS OR COMMERCIAL LOSS IN ANY WAY CONNECTED WITH THE PRODUCTS, WHETHER SUCH CLAIM IS BASED ON CONTRACT, WARRANTY, NEGLIGENCE, OR STRICT LIABILITY.

In no event shall the responsibility of OMRON for any act exceed the individual price of the product on which liability is asserted.

IN NO EVENT SHALL OMRON BE RESPONSIBLE FOR WARRANTY, REPAIR, OR OTHER CLAIMS REGARDING THE PRODUCTS UNLESS OMRON'S ANALYSIS CONFIRMS THAT THE PRODUCTS WERE PROPERLY HANDLED, STORED, INSTALLED, AND MAINTAINED AND NOT SUBJECT TO CONTAMINATION, ABUSE, MISUSE, OR INAPPROPRIATE MODIFICATION OR REPAIR.

Application Considerations

SUITABILITY FOR USE

OMRON shall not be responsible for conformity with any standards, codes, or regulations that apply to the combination of products in the customer's application or use of the products.

At the customer's request, OMRON will provide applicable third party certification documents identifying ratings and limitations of use that apply to the products. This information by itself is not sufficient for a complete determination of the suitability of the products in combination with the end product, machine, system, or other application or use.

The following are some examples of applications for which particular attention must be given. This is not intended to be an exhaustive list of all possible uses of the products, nor is it intended to imply that the uses listed may be suitable for the products:

- Outdoor use, uses involving potential chemical contamination or electrical interference, or conditions or uses not described in this catalog.
- Nuclear energy control systems, combustion systems, railroad systems, aviation systems, medical equipment, amusement machines, vehicles, safety equipment, and installations subject to separate industry or government regulations.
- Systems, machines, and equipment that could present a risk to life or property.

Please know and observe all prohibitions of use applicable to the products.

NEVER USE THE PRODUCTS FOR AN APPLICATION INVOLVING SERIOUS RISK TO LIFE OR PROPERTY WITHOUT ENSURING THAT THE SYSTEM AS A WHOLE HAS BEEN DESIGNED TO ADDRESS THE RISKS, AND THAT THE OMRON PRODUCTS ARE PROPERLY RATED AND INSTALLED FOR THE INTENDED USE WITHIN THE OVERALL EQUIPMENT OR SYSTEM.

PROGRAMMABLE PRODUCTS

OMRON shall not be responsible for the user's programming of a programmable product, or any consequence thereof.

Disclaimers

CHANGE IN SPECIFICATIONS

Product specifications and accessories may be changed at any time based on improvements and other reasons.

It is our practice to change model numbers when published ratings or features are changed, or when significant construction changes are made. However, some specifications of the products may be changed without any notice. When in doubt, special model numbers may be assigned to fix or establish key specifications for your application on your request. Please consult with your OMRON representative at any time to confirm actual specifications of purchased products.

DIMENSIONS AND WEIGHTS

Dimensions and weights are nominal and are not to be used for manufacturing purposes, even when tolerances are shown.

PERFORMANCE DATA

Performance data given in this catalog is provided as a guide for the user in determining suitability and does not constitute a warranty. It may represent the result of OMRON's test conditions, and the users must correlate it to actual application requirements. Actual performance is subject to the OMRON Warranty and Limitations of Liability.

ERRORS AND OMISSIONS

The information in this document has been carefully checked and is believed to be accurate; however, no responsibility is assumed for clerical, typographical, or proofreading errors, or omissions.



OMRON ELECTRONICS LLC • THE AMERICAS HEADQUARTERS • Schaumburg, IL USA • 847.843.7900 • 800.556.6766 • www.omron247.com

OMRON CANADA, INC. • HEAD OFFICE

Toronto, ON, Canada • 416.286.6465 • 866.986.6766
www.omron247.com

OMRON ELETRÔNICA DO BRASIL LTDA • HEAD OFFICE

São Paulo, SP, Brasil • 55.11.2101.6300 • www.omron.com.br

OMRON ELECTRONICS MEXICO SA DE CV • HEAD OFFICE

Apodaca, N.L. • 52.811.156.99.10 • 001.800.556.6766 • mela@omron.com

OMRON ARGENTINA • SALES OFFICE

Cono Sur • 54.11.4783.5300

OMRON CHILE • SALES OFFICE

Santiago • 56.9.9917.3920

OTHER OMRON LATIN AMERICA SALES

54.11.4783.5300

OMRON EUROPE B.V. Wegalaan 67-69, NL-2132 JD, Hoofddorp, The Netherlands. Tel: +31 (0) 23 568 13 00 Fax: +31 (0) 23 568 13 88 www.industrial.omron.eu

Компания «Life Electronics» занимается поставками электронных компонентов импортного и отечественного производства от производителей и со складов крупных дистрибьюторов Европы, Америки и Азии.

С конца 2013 года компания активно расширяет линейку поставок компонентов по направлению коаксиальный кабель, кварцевые генераторы и конденсаторы (керамические, пленочные, электролитические), за счёт заключения дистрибьюторских договоров

Мы предлагаем:

- Конкурентоспособные цены и скидки постоянным клиентам.
- Специальные условия для постоянных клиентов.
- Подбор аналогов.
- Поставку компонентов в любых объемах, удовлетворяющих вашим потребностям.
- Приемлемые сроки поставки, возможна ускоренная поставка.
- Доставку товара в любую точку России и стран СНГ.
- Комплексную поставку.
- Работу по проектам и поставку образцов.
- Формирование склада под заказчика.
- Сертификаты соответствия на поставляемую продукцию (по желанию клиента).
- Тестирование поставляемой продукции.
- Поставку компонентов, требующих военную и космическую приемку.
- Входной контроль качества.
- Наличие сертификата ISO.

В составе нашей компании организован Конструкторский отдел, призванный помогать разработчикам, и инженерам.

Конструкторский отдел помогает осуществить:

- Регистрацию проекта у производителя компонентов.
- Техническую поддержку проекта.
- Защиту от снятия компонента с производства.
- Оценку стоимости проекта по компонентам.
- Изготовление тестовой платы монтаж и пусконаладочные работы.



Тел: +7 (812) 336 43 04 (многоканальный)

Email: org@lifeelectronics.ru