

EL5104, EL5105, EL5204, EL5205, EL5304

700MHz Slew-Enhanced VFAs

FN7332
Rev 8.00
May 25, 2016

The EL5104, EL5105, EL5204, EL5205, and EL5304 represent high speed voltage feedback amplifiers based on the current feedback amplifier architecture. This gives the typical high slew rate benefits of a CFA family along with the stability and ease of use associated with the VFA type architecture. This family is available in single, dual, and triple versions, with 200MHz, 400MHz, and 700MHz versions. This family operates on single 5V or $\pm 5V$ supplies from minimum supply current. The EL5104 and EL5204 also feature an output enable function, which can be used to put the output in to a high-impedance mode. This enables the outputs of multiple amplifiers to be tied together for use in multiplexing applications.

Features

- Specified for 5V or $\pm 5V$ applications
- Power-down to $17\mu A$
- -3dB bandwidth = 700MHz
- ± 0.1 dB bandwidth = 45MHz
- Low supply current = 9.5mA
- Slew rate = $7000V/\mu s$
- Low offset voltage = 10mV max
- Output current = 160mA
- $A_{VOL} = 1400$
- Diff gain/phase = 0.01%/0.02°
- Pb-free plus anneal available (RoHS compliant)

Applications

- Video amplifiers
- PCMCIA applications
- A/D drivers
- Line drivers
- Portable computers
- High speed communications
- RGB applications
- Broadcast equipment
- Active filtering

Pinouts

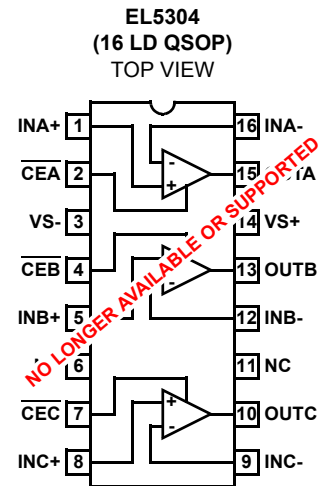
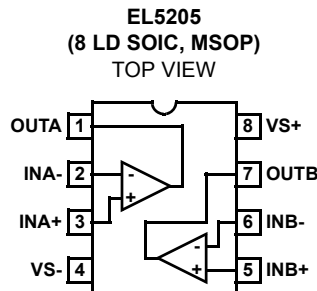
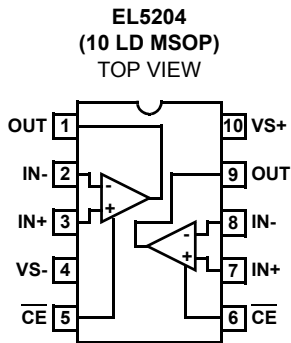
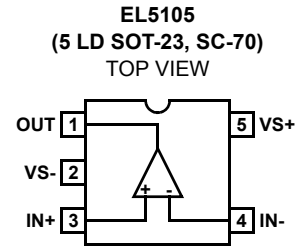
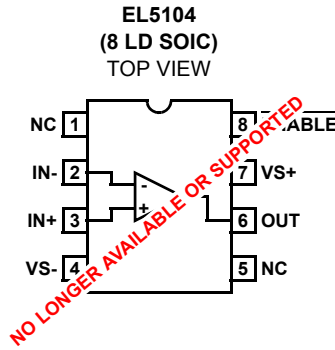
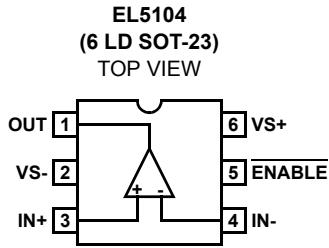

Ordering Information

PART NUMBER	PART MARKING	TAPE & REEL	PACKAGE	PKG. DWG. #
EL5104ISZ (Note) (No longer available, recommended replacement: EL5104IWZ-T7)	5104ISZ	-	8 Ld SOIC (150 mil) (Pb-Free)	MDP0027
EL5104ISZ-T7 (Note) (No longer available, recommended replacement: EL5104IWZ-T7)	5104ISZ	7"	8 Ld SOIC (150 mil) (Pb-Free)	MDP0027
EL5104ISZ-T13 (Note) (No longer available, recommended replacement: EL5104IWZ-T7)	5104ISZ	13"	8 Ld SOIC (150 mil) (Pb-Free)	MDP0027
EL5104IWZ-T7 (Note)	BAEA	7" (3k pcs)	6 Ld SOT-23 (Pb-Free)	P5.064A
EL5104IWZ-T7A (Note)	BAEA	7" (250 pcs)	6 Ld SOT-23 (Pb-Free)	P5.064A
EL5105IC (No longer available or supported)	C	-	5 Ld SC-70 (1.25mm)	P5.049
EL5105IWZ-T7 (Note)	BBMA	7" (3k pcs)	5 Ld SOT-23 (Pb-Free)	P5.064A
EL5105IWZ-T7A (Note)	BBMA	7" (250 pcs)	5 Ld SOT-23 (Pb-Free)	P5.064A
EL5204IYZ (Note)	BAAAF	-	10 Ld MSOP (3.0mm) (Pb-Free)	MDP0043
EL5204IYZ-T7 (Note)	BAAAF	7"	10 Ld MSOP (3.0mm) (Pb-Free)	MDP0043
EL5204IYZ-T13 (Note)	BAAAF	13"	10 Ld MSOP (3.0mm) (Pb-Free)	MDP0043

Ordering Information (Continued)

PART NUMBER	PART MARKING	TAPE & REEL	PACKAGE	PKG. DWG. #
EL5205ISZ (Note)	5205ISZ	-	8 Ld SOIC (150 mil) (Pb-Free)	MDP0027
EL5205ISZ-T7 (Note)	5205ISZ	7"	8 Ld SOIC (150 mil) (Pb-Free)	MDP0027
EL5205ISZ-T13 (Note)	5205ISZ	13"	8 Ld SOIC (150 mil) (Pb-Free)	MDP0027
EL5304IU (No longer available or supported)	5304IU	-	16 Ld QSOP (150 mil)	MDP0040
EL5304IU-T7 (No longer available or supported)	5304IU	7"	16 Ld QSOP (150 mil)	MDP0040
EL5304IU-T13 (No longer available or supported)	5304IU	13"	16 Ld QSOP (150 mil)	MDP0040
EL5304IUZ (Note) (No longer available or supported)	5304IUZ	-	16 Ld QSOP (150 mil) (Pb-Free)	MDP0040
EL5304IUZ-T7 (Note) (No longer available or supported)	5304IUZ	7"	16 Ld QSOP (150 mil) (Pb-Free)	MDP0040
EL5304IUZ-T13 (Note) (No longer available or supported)	5304IUZ	13"	16 Ld QSOP (150 mil) (Pb-Free)	MDP0040

NOTE: Intersil Pb-free plus anneal products employ special Pb-free material sets; molding compounds/die attach materials and 100% matte tin plate termination finish, which are RoHS compliant and compatible with both SnPb and Pb-free soldering operations. Intersil Pb-free products are MSL classified at Pb-free peak reflow temperatures that meet or exceed the Pb-free requirements of IPC/JEDEC J STD-020.

Absolute Maximum Ratings ($T_A = +25^\circ\text{C}$)

Supply Voltage between V_{S+} and GND. 13.2V
 Input Voltage $\pm V_S$
 Differential Input Voltage $\pm 4\text{V}$
 Maximum Output Current. 80mA
 V_{S+} to V_{S-} Maximum Slew Rate 1V/ μs

Thermal Information

Storage Temperature Range -65°C to $+150^\circ\text{C}$
 Ambient Operating Temperature Range -40°C to $+85^\circ\text{C}$
 Operating Junction Temperature $+150^\circ\text{C}$
 Pb-free reflow profile see link below
<http://www.intersil.com/pbfree/Pb-FreeReflow.asp>

CAUTION: Stresses above those listed in "Absolute Maximum Ratings" may cause permanent damage to the device. This is a stress only rating and operation of the device at these or any other conditions above those indicated in the operational sections of this specification is not implied.

IMPORTANT NOTE: All parameters having Min/Max specifications are guaranteed. Typical values are for information purposes only. Unless otherwise noted, all tests are at the specified temperature and are pulsed tests, therefore: $T_J = T_C = T_A$

DC Electrical Specifications $V_S = \pm 5\text{V}$, $\text{GND} = 0\text{V}$, $T_A = +25^\circ\text{C}$, $V_{CM} = 0\text{V}$, $V_{OUT} = 0\text{V}$, $V_{ENABLE} = \text{GND}$ or OPEN , Unless Otherwise Specified.

PARAMETER	DESCRIPTION	CONDITIONS	MIN	TYP	MAX	UNIT
V _{OS}	Offset Voltage	EL5104, EL5105, EL5204, EL5205	-10	3	10	mV
		EL5304	-18	5	18	mV
TCV _{OS}	Offset Voltage Temperature Coefficient	Measured from T _{MIN} to T _{MAX}		10		$\mu\text{V}/^\circ\text{C}$
I _B	Input Bias Current	$V_{IN} = 0\text{V}$		8	30	μA
I _{OS}	Input Offset Current	$V_{IN} = 0\text{V}$		4	15	μA
TCI _{OS}	Input Bias Current Temperature Coefficient	Measured from T _{MIN} to T _{MAX}		50		$\text{nA}/^\circ\text{C}$
PSRR	Power Supply Rejection Ratio		60	70		dB
CMRR	Common Mode Rejection Ratio	V_{CM} from -3V to $+3\text{V}$	56	62		dB
CMIR	Common Mode Input Range	Guaranteed by CMRR test	-3		+3	V
R _{IN}	Input Resistance	Common mode	50	120		k Ω
C _{IN}	Input Capacitance	SO package		1		pF
I _{S,ON}	Supply Current - Enabled	Per amplifier	8.5	9.5	11	mA
I _{S,OFF}	Supply Current - Shut Down	V_{S+} , per amplifier	+1	0	+25	μA
		V_{S-} , per amplifier	-25	17	-1	μA
PSOR	Power Supply Operating Range		4		13.2	V
AVOL	Open Loop Gain	$R_L = 1\text{k}\Omega$ to GND	55	65		dB
		$R_L = 150\Omega$ to GND		60		dB
V _{OP}	Positive Output Voltage Swing	$R_L = 150\Omega$ to 0V	3.6	3.8		V
V _{ON}	Negative Output Voltage Swing	$R_L = 150\Omega$ to 0V		-3.8	-3.6	V
I _{OUT}	Output Current	$R_L = 10\Omega$ to 0V	± 90	± 160		mA
V _{IH-EN}	ENABLE Pin Voltage for Power Up		(V_{S+}) -5		(V_{S+}) -3	V
V _{IL-EN}	ENABLE Pin Voltage for Shut Down		(V_{S+}) -1		V_{S+}	V

Closed Loop AC Electrical Specifications $V_S = +5V$, $GND = 0V$, $T_A = +25^\circ C$, $V_{CM} = +1.5V$, $V_{OUT} = +1.5V$, $V_{CLAMP} = +5V$,
 $V_{ENABLE} = 0V$, $A_V = +1$, $R_F = 0\Omega$, $R_L = 150\Omega$ to GND pin, unless otherwise specified.

PARAMETER	DESCRIPTION	CONDITIONS	MIN	TYP	MAX	UNIT
BW	-3dB Bandwidth ($V_{OUT} = 200mV_{P-P}$)	$V_S = \pm 5V$, $A_V = 1$, $R_F = 0\Omega$		700		MHz
SR	Slew Rate	$R_L = 100\Omega$, $V_{OUT} = -3V$ to $+3V$	2000	3000	7000	V/ μs
t_R , t_F	Rise Time, Fall Time	$\pm 0.1V$ step		0.4		ns
OS	Overshoot	$\pm 0.1V$ step		10		%
t_{PD}	Propagation Delay	$\pm 0.1V$ step		0.4		ns
t_S	0.1% Settling Time	$V_S = \pm 5V$, $R_L = 500\Omega$, $A_V = 1$, $V_{OUT} = \pm 2.5V$		7		ns
dG	Differential Gain	$A_V = 2$, $R_L = 150\Omega$, $V_{INDC} = -1$ to $+1V$		0.01		%
dP	Differential Phase	$A_V = 2$, $R_L = 150\Omega$, $V_{INDC} = -1$ to $+1V$		0.02		$^\circ$
e_N	Input Noise Voltage	$f = 10kHz$		10		nV/ \sqrt{Hz}
i_N	Input Noise Current	$f = 10kHz$		54		pA/ \sqrt{Hz}
t_{DIS}	Disable Time			180		ns
t_{EN}	Enable Time			650		ns
I_{EN}	Enable Pin Current	Enabled, $V_{EN} = 0V$	-1		1	μA
		Disabled, $V_{EN} = 5V$	1		25	μA

Typical Performance Curves

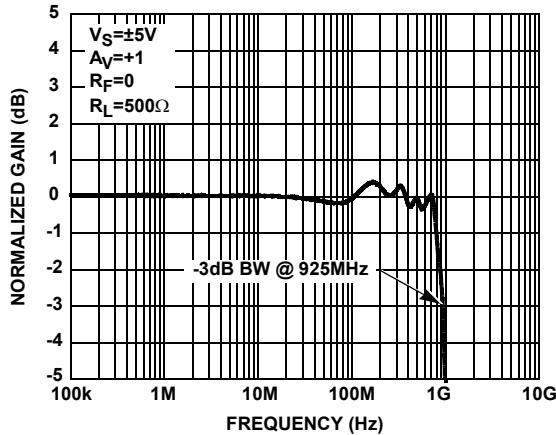

FIGURE 1. GAIN vs FREQUENCY (-3dB BANDWIDTH)

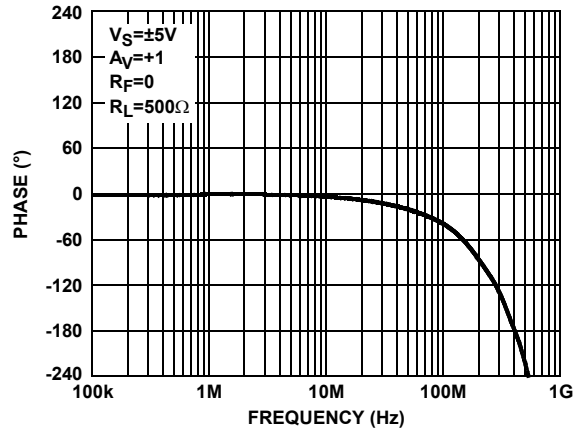

FIGURE 2. PHASE vs FREQUENCY

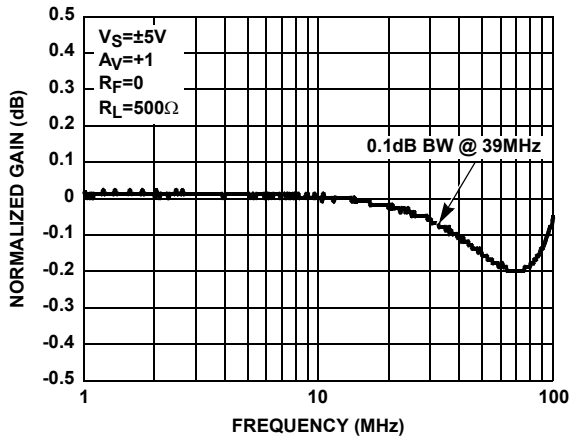

FIGURE 3. 0.1dB BANDWIDTH

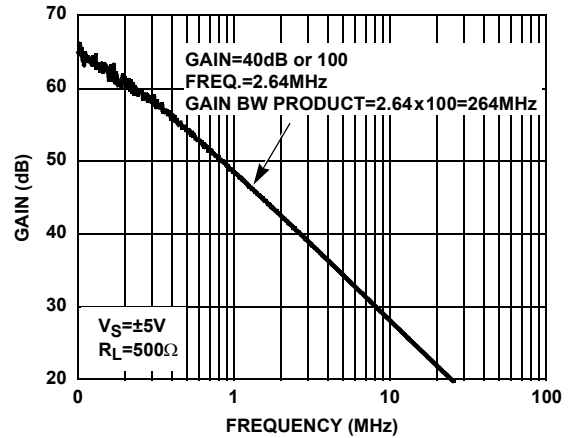

FIGURE 4. GAIN BANDWIDTH PRODUCT

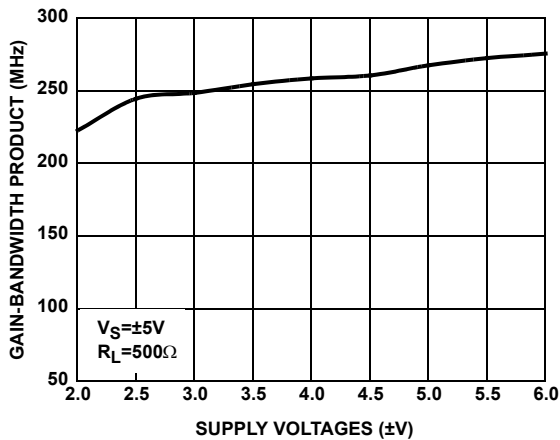

FIGURE 5. GAIN BANDWIDTH PRODUCT vs SUPPLY VOLTAGES

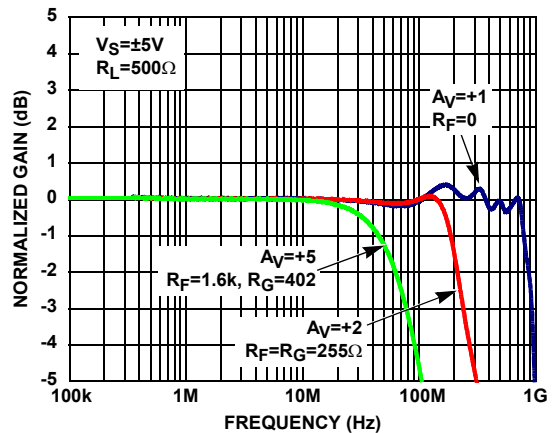

FIGURE 6. GAIN vs FREQUENCY FOR VARIOUS +AV

Typical Performance Curves (Continued)

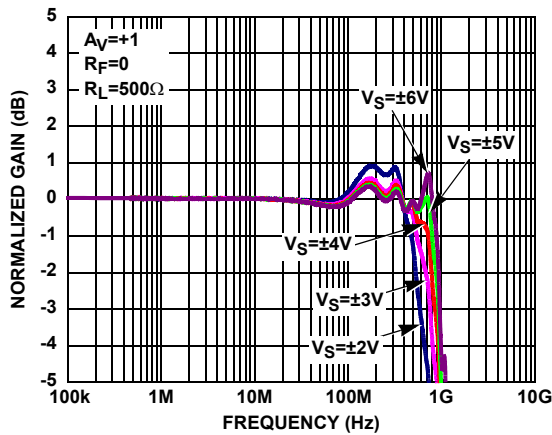

FIGURE 7. GAIN vs FREQUENCY FOR VARIOUS $\pm V_S$

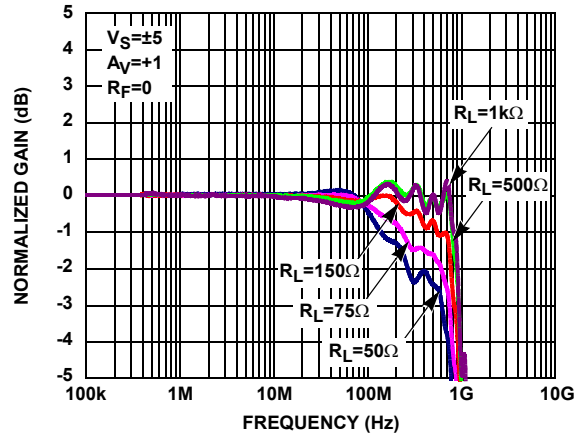

FIGURE 8. GAIN vs FREQUENCY FOR VARIOUS R_L ($A_V=+1$)

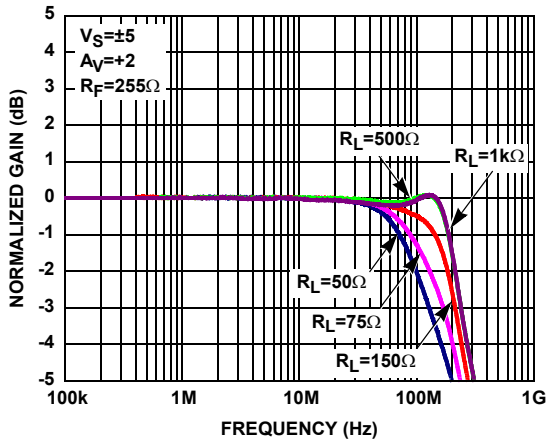

FIGURE 9. GAIN vs FREQUENCY FOR VARIOUS R_L ($A_V=+2$)

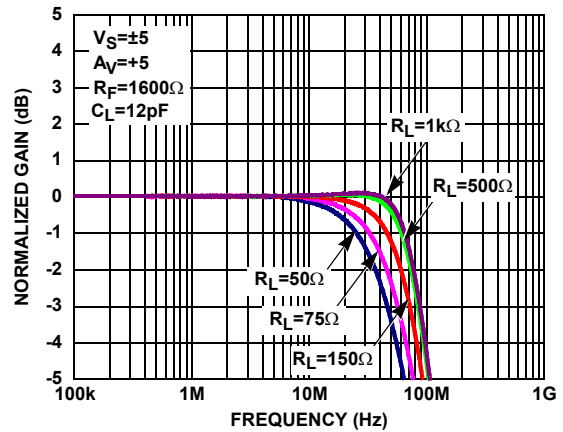

FIGURE 10. GAIN vs FREQUENCY FOR VARIOUS R_L ($A_V=+5$)

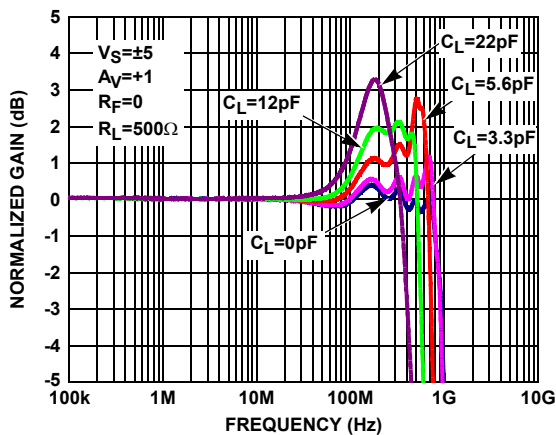

FIGURE 11. GAIN vs FREQUENCY FOR VARIOUS C_L ($A_V=+1$)

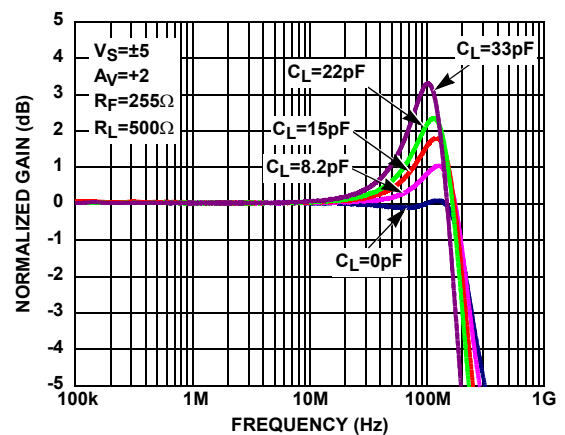

FIGURE 12. GAIN vs FREQUENCY FOR VARIOUS C_L ($A_V=+2$)

Typical Performance Curves (Continued)

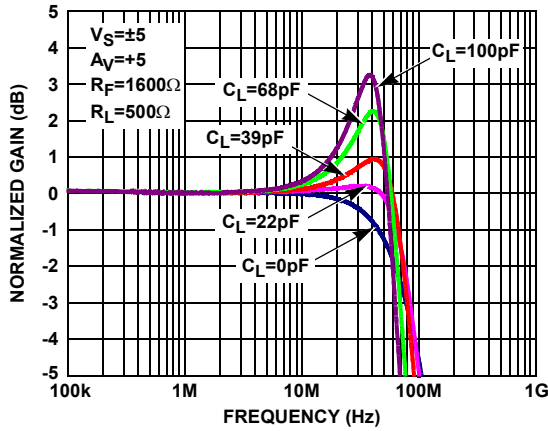

FIGURE 13. GAIN vs FREQUENCY FOR VARIOUS C_L ($A_V = +5$)

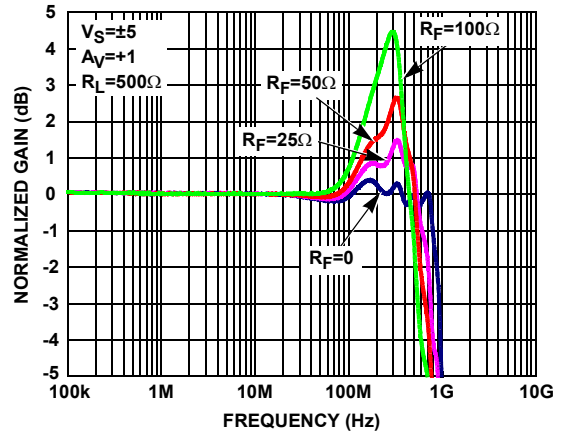

FIGURE 14. GAIN vs FREQUENCY FOR VARIOUS R_F ($A_V = +1$)

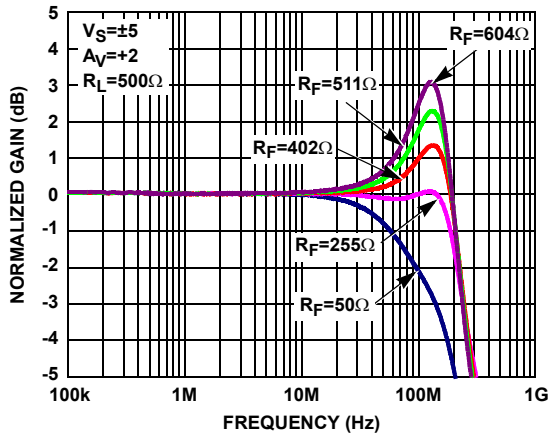

FIGURE 15. GAIN vs FREQUENCY FOR VARIOUS R_F ($A_V = +2$)

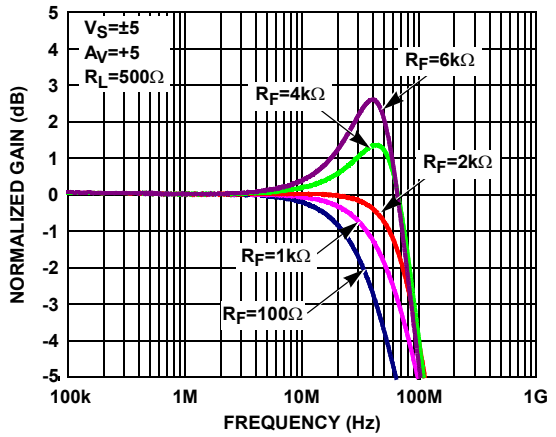

FIGURE 16. GAIN vs FREQUENCY FOR VARIOUS R_F ($A_V = +5$)

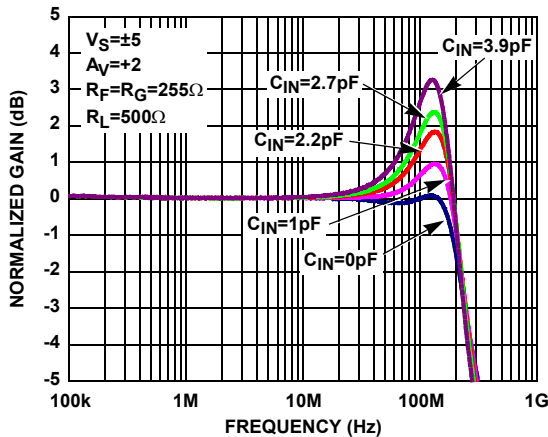

FIGURE 17. GAIN vs FREQUENCY FOR VARIOUS $C_{IN(-)}$ ($A_V = +2$)

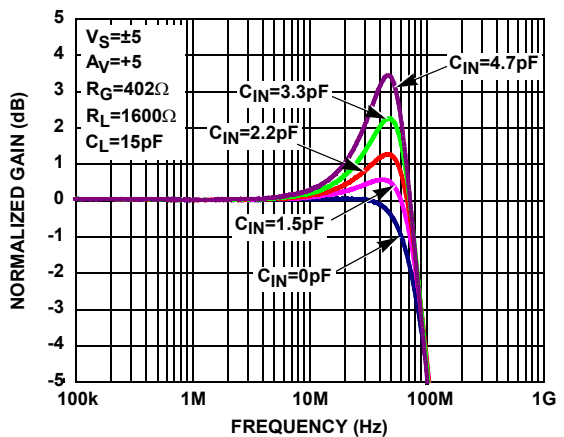

FIGURE 18. GAIN vs FREQUENCY FOR VARIOUS $C_{IN(-)}$ ($A_V = +5$)

Typical Performance Curves (Continued)

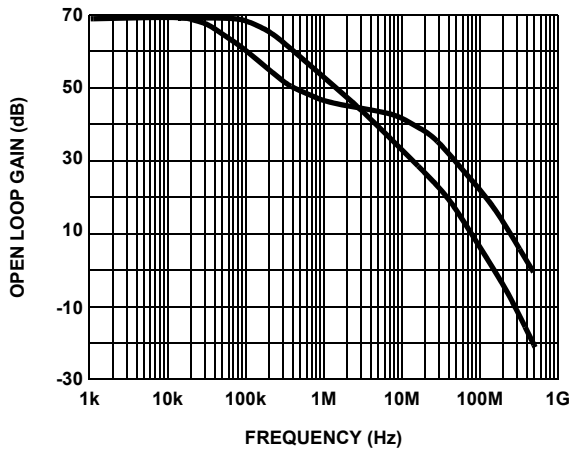

FIGURE 19. OPEN LOOP GAIN AND PHASE vs FREQUENCY

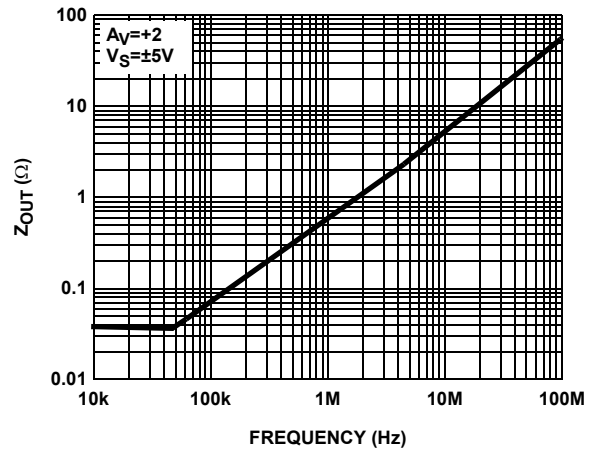

FIGURE 20. Z_{OUT} vs FREQUENCY

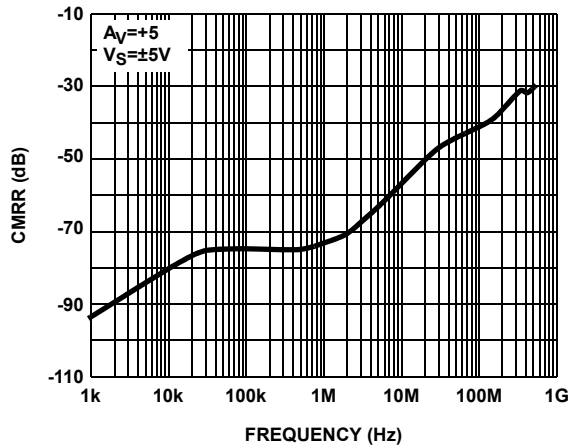

FIGURE 21. CMRR vs FREQUENCY

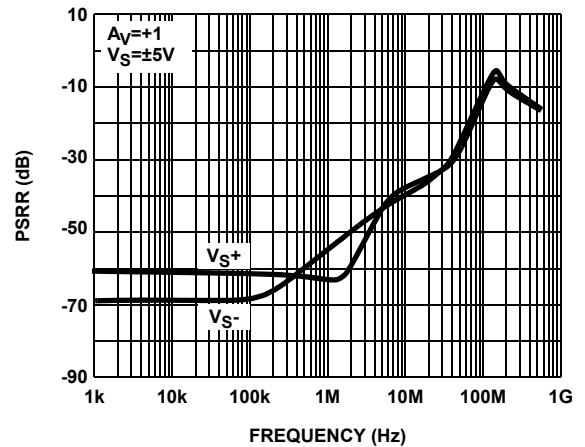

FIGURE 22. PSRR vs FREQUENCY

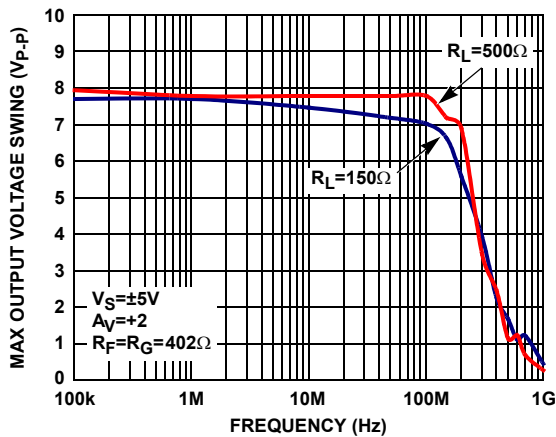

FIGURE 23. MAX OUTPUT VOLTAGE SWING vs FREQUENCY

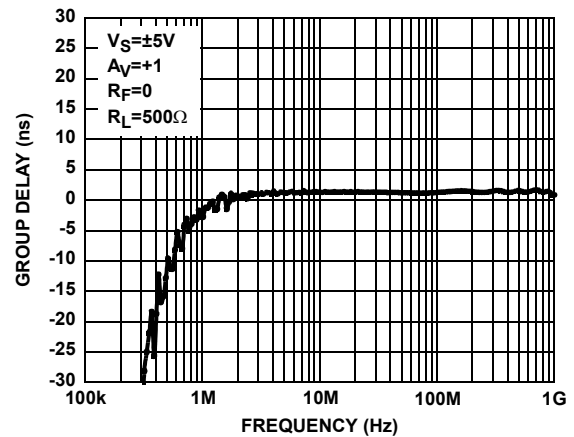

FIGURE 24. GROUP DELAY vs FREQUENCY

Typical Performance Curves (Continued)

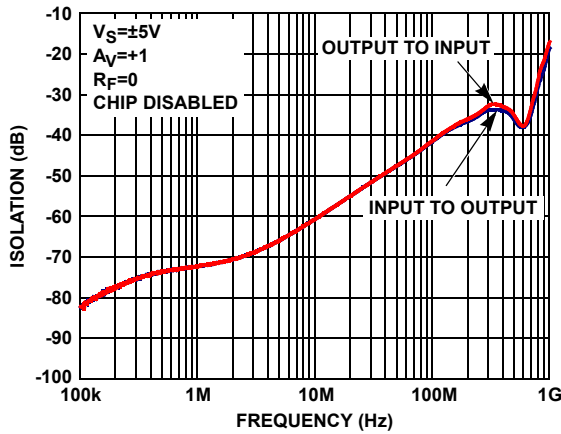

FIGURE 25. INPUT AND OUTPUT ISOLATION

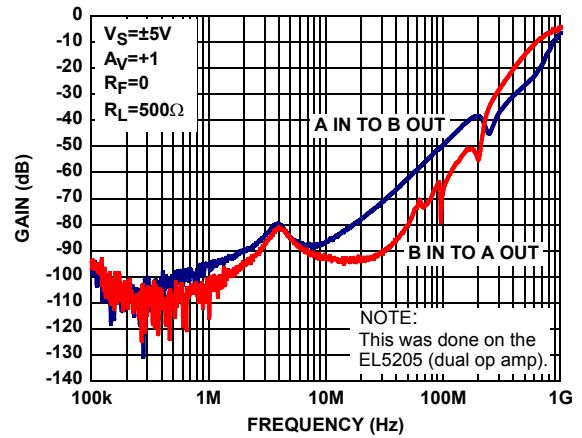

FIGURE 26. CHANNEL TO CHANNEL ISOLATION

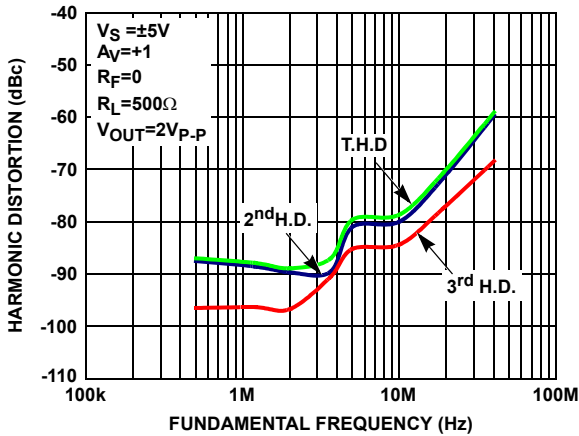

FIGURE 27. HARMONIC DISTORTION vs FREQUENCY

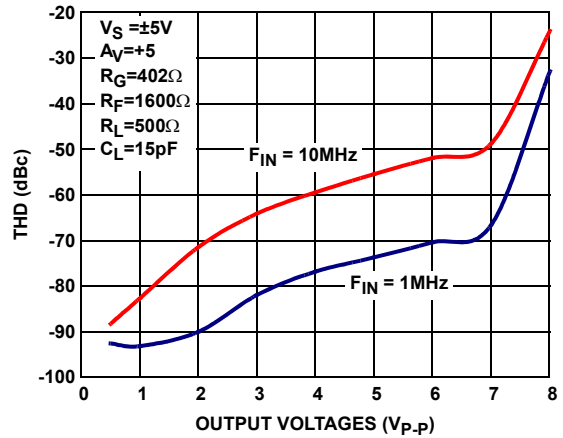

FIGURE 28. TOTAL HARMONIC DISTORTION vs OUTPUT VOLTAGES

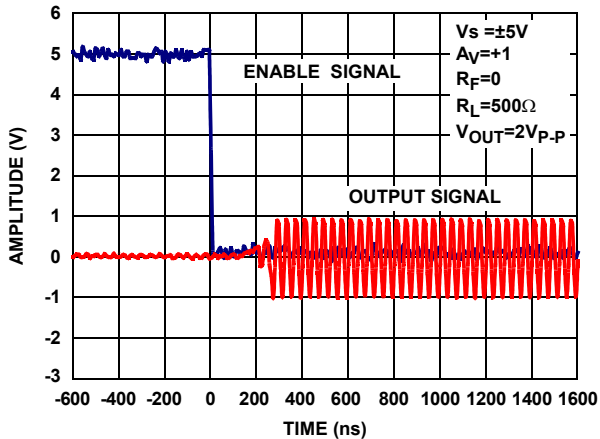

FIGURE 29. TURN-ON TIME

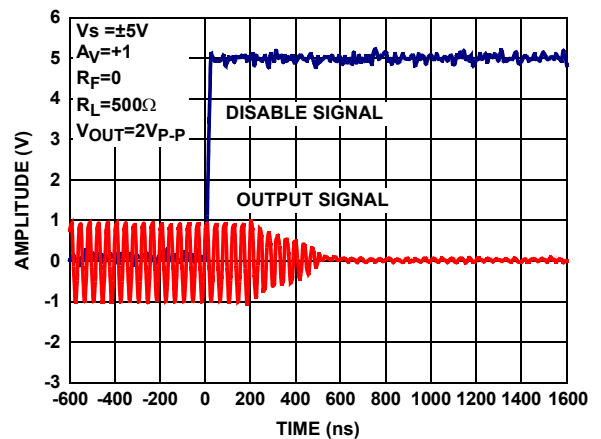

FIGURE 30. TURN-OFF TIME

Typical Performance Curves (Continued)

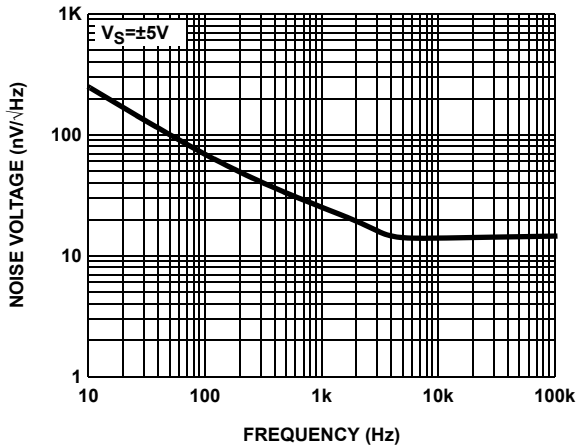

FIGURE 31. EQUIVALENT NOISE VOLTAGE vs FREQUENCY

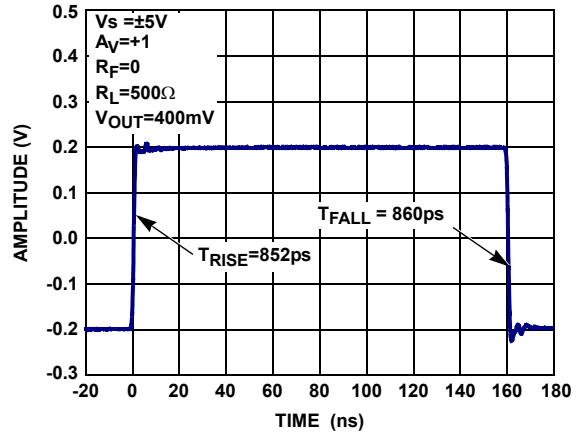

FIGURE 32. SMALL SIGNAL STEP RESPONSE_RISE & FALL TIME

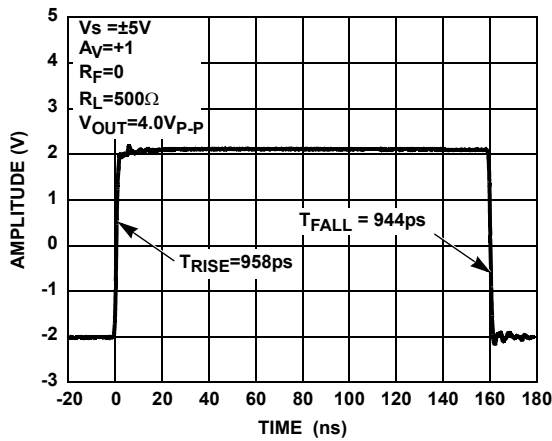

FIGURE 33. LARGE SIGNAL STEP RESPONSE_RISE & FALL TIME

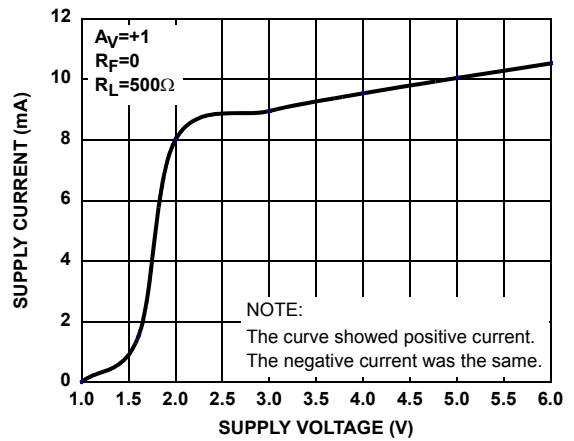

FIGURE 34. SUPPLY CURRENT vs SUPPLY VOLTAGE

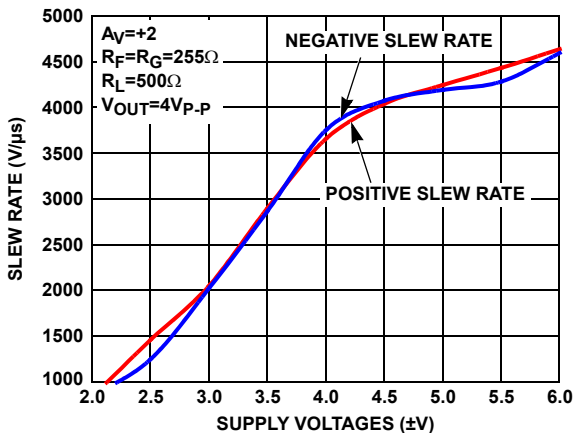

FIGURE 35. SLEW RATE vs SUPPLY VOLTAGES

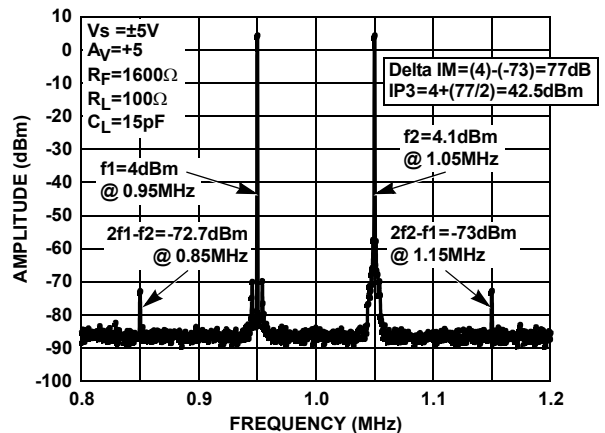

FIGURE 36. THIRD ORDER IMD INTERCEPT (IP3)

Typical Performance Curves (Continued)

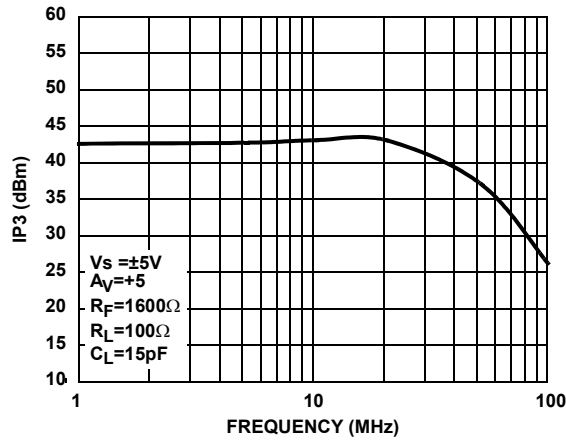

FIGURE 37. THIRD ORDER IMD INTERCEPT vs FREQUENCY

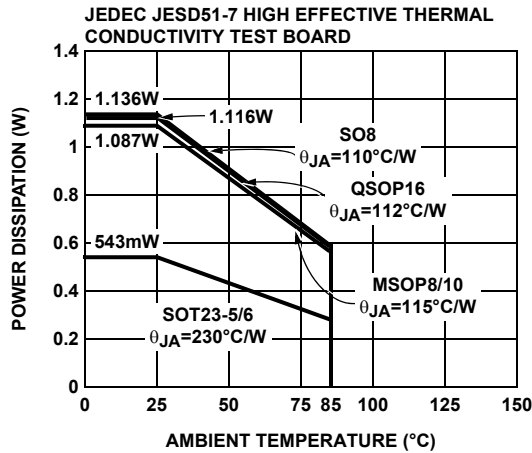

FIGURE 38. PACKAGE POWER DISSIPATION vs AMBIENT TEMPERATURE

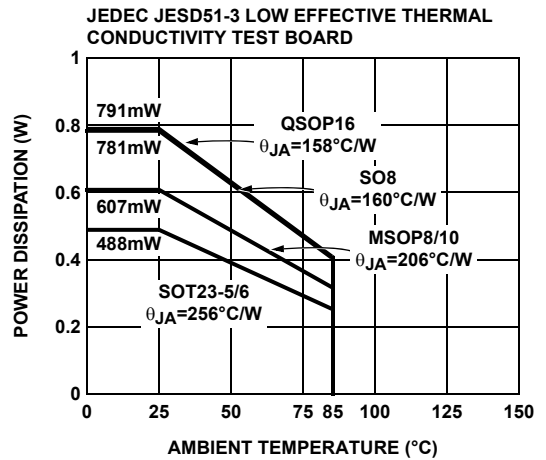

FIGURE 39. PACKAGE POWER DISSIPATION vs AMBIENT TEMPERATURE

Revision History

The revision history provided is for informational purposes only and is believed to be accurate, but not warranted. Please go to the web to make sure that you have the latest revision.

DATE	REVISION	CHANGE
May 25, 2016	FN7332.8	- Updated Ordering Information Table on page 2.
October 20, 2015	FN7332.7	- Updated Ordering Information Table on page 2. - Added Revision History. - Added About Intersil Verbiage. - POD MDP0038 obsoleted and replaced by P5.064A latest revision.

About Intersil

Intersil Corporation is a leading provider of innovative power management and precision analog solutions. The company's products address some of the largest markets within the industrial and infrastructure, mobile computing and high-end consumer markets.

For the most updated datasheet, application notes, related documentation and related parts, please see the respective product information page found at www.intersil.com.

You may report errors or suggestions for improving this datasheet by visiting www.intersil.com/ask.

Reliability reports are also available from our website at www.intersil.com/support.

© Copyright Intersil Americas LLC 2004-2016. All Rights Reserved.
All trademarks and registered trademarks are the property of their respective owners.

For additional products, see www.intersil.com/en/products.html

Intersil products are manufactured, assembled and tested utilizing ISO9001 quality systems as noted in the quality certifications found at www.intersil.com/en/support/qualandreliability.html

Intersil products are sold by description only. Intersil may modify the circuit design and/or specifications of products at any time without notice, provided that such modification does not, in Intersil's sole judgment, affect the form, fit or function of the product. Accordingly, the reader is cautioned to verify that datasheets are current before placing orders. Information furnished by Intersil is believed to be accurate and reliable. However, no responsibility is assumed by Intersil or its subsidiaries for its use; nor for any infringements of patents or other rights of third parties which may result from its use. No license is granted by implication or otherwise under any patent or patent rights of Intersil or its subsidiaries.

For information regarding Intersil Corporation and its products, see www.intersil.com

Mini SO Package Family (MSOP)

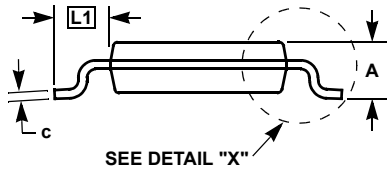

MDP0043 MINI SO PACKAGE FAMILY

SYMBOL	MILLIMETERS		TOLERANCE	NOTES
	MSOP8	MSOP10		
A	1.10	1.10	Max.	-
A1	0.10	0.10	±0.05	-
A2	0.86	0.86	±0.09	-
b	0.33	0.23	+0.07/-0.08	-
c	0.18	0.18	±0.05	-
D	3.00	3.00	±0.10	1, 3
E	4.90	4.90	±0.15	-
E1	3.00	3.00	±0.10	2, 3
e	0.65	0.50	Basic	-
L	0.55	0.55	±0.15	-
L1	0.95	0.95	Basic	-
N	8	10	Reference	-

Rev. D 2/07

NOTES:

1. Plastic or metal protrusions of 0.15mm maximum per side are not included.
2. Plastic interlead protrusions of 0.25mm maximum per side are not included.
3. Dimensions "D" and "E1" are measured at Datum Plane "H".
4. Dimensioning and tolerancing per ASME Y14.5M-1994.

Small Outline Package Family (SO)

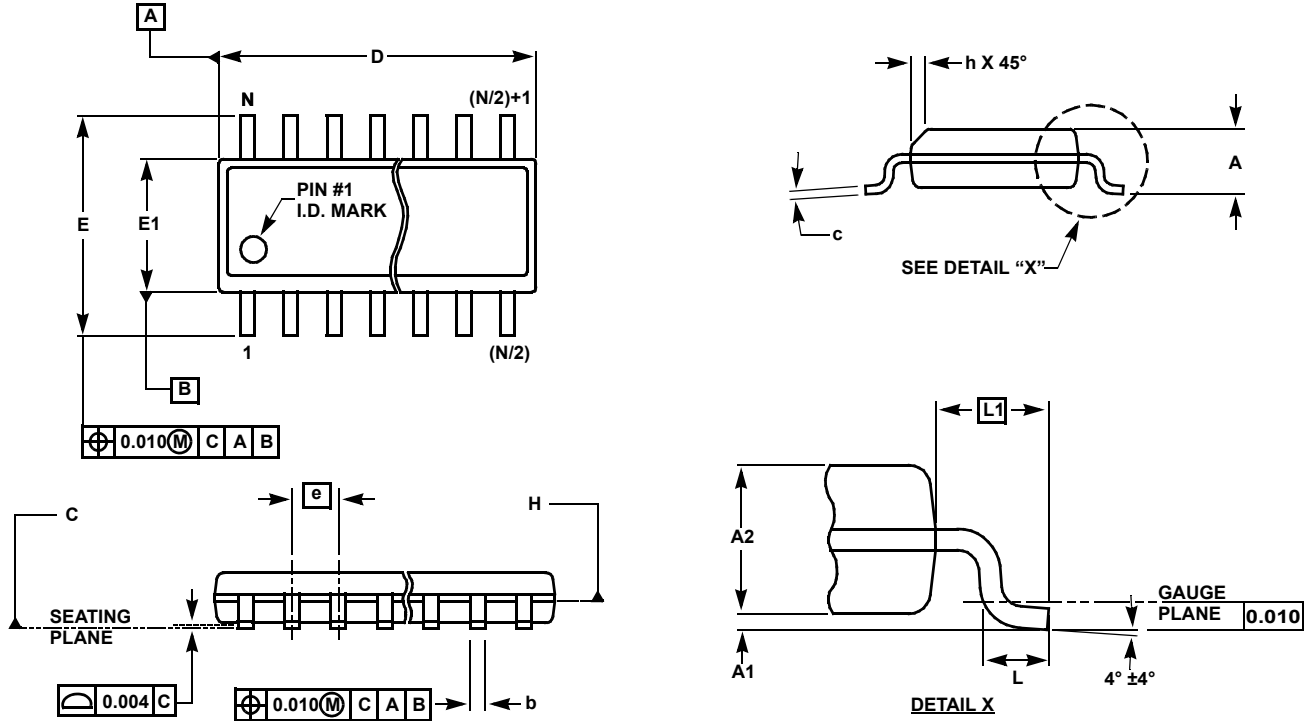

MDP0027

SMALL OUTLINE PACKAGE FAMILY (SO)

SYMBOL	INCHES							TOLERANCE	NOTES
	SO-8	SO-14	SO16 (0.150")	SO16 (0.300") (SOL-16)	SO20 (SOL-20)	SO24 (SOL-24)	SO28 (SOL-28)		
A	0.068	0.068	0.068	0.104	0.104	0.104	0.104	MAX	-
A1	0.006	0.006	0.006	0.007	0.007	0.007	0.007	±0.003	-
A2	0.057	0.057	0.057	0.092	0.092	0.092	0.092	±0.002	-
b	0.017	0.017	0.017	0.017	0.017	0.017	0.017	±0.003	-
c	0.009	0.009	0.009	0.011	0.011	0.011	0.011	±0.001	-
D	0.193	0.341	0.390	0.406	0.504	0.606	0.704	±0.004	1, 3
E	0.236	0.236	0.236	0.406	0.406	0.406	0.406	±0.008	-
E1	0.154	0.154	0.154	0.295	0.295	0.295	0.295	±0.004	2, 3
e	0.050	0.050	0.050	0.050	0.050	0.050	0.050	Basic	-
L	0.025	0.025	0.025	0.030	0.030	0.030	0.030	±0.009	-
L1	0.041	0.041	0.041	0.056	0.056	0.056	0.056	Basic	-
h	0.013	0.013	0.013	0.020	0.020	0.020	0.020	Reference	-
N	8	14	16	16	20	24	28	Reference	-

Rev. M 2/07

NOTES:

1. Plastic or metal protrusions of 0.006" maximum per side are not included.
2. Plastic interlead protrusions of 0.010" maximum per side are not included.
3. Dimensions "D" and "E1" are measured at Datum Plane "H".
4. Dimensioning and tolerancing per ASME Y14.5M-1994

Package Outline Drawing

P5.064A

5 LEAD SMALL OUTLINE TRANSISTOR PLASTIC PACKAGE

Rev 0, 2/10

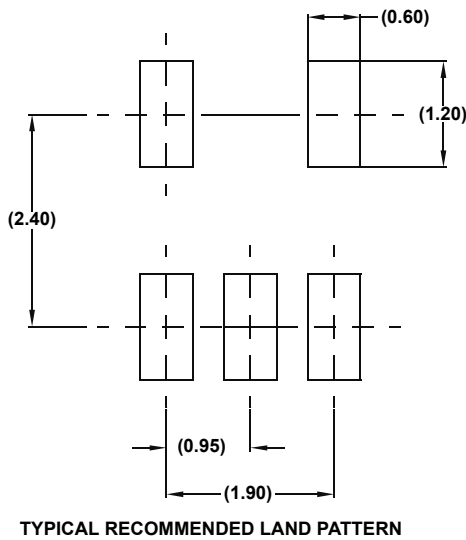
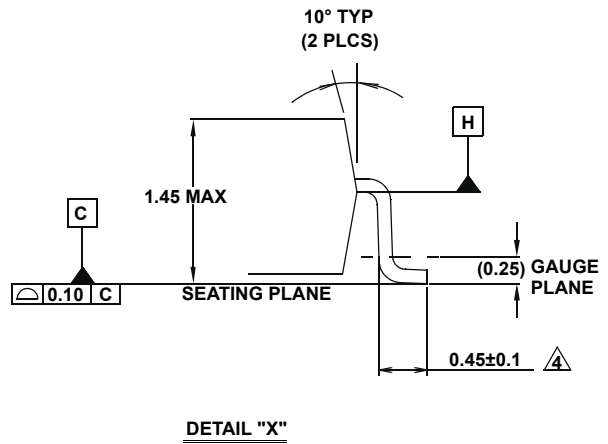
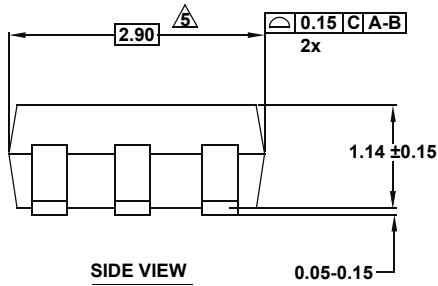
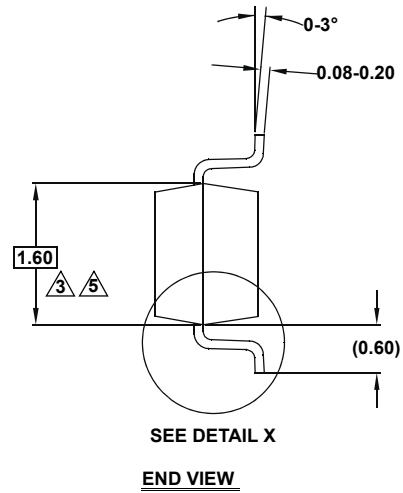
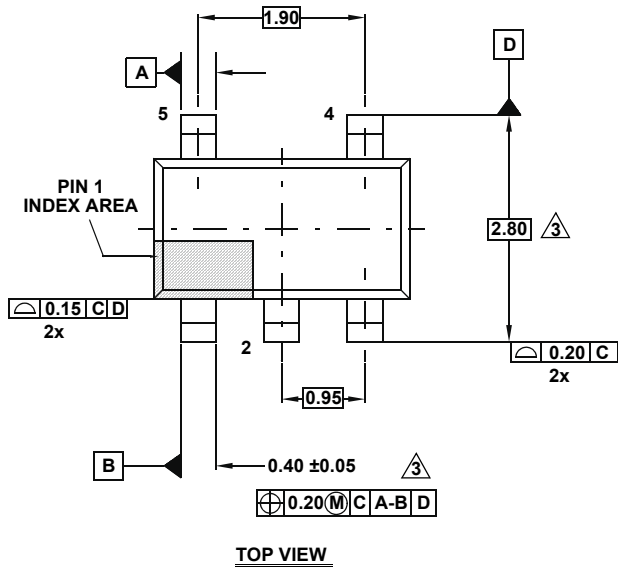

NOTES:

1. Dimensions are in millimeters.
Dimensions in () for Reference Only.
2. Dimensioning and tolerancing conform to ASME Y14.5M-1994.
3. Dimension is exclusive of mold flash, protrusions or gate burrs.
4. Foot length is measured at reference to gauge plane.
5. This dimension is measured at Datum "H".
6. Package conforms to JEDEC MO-178AA.

Quarter Size Outline Plastic Packages Family (QSOP)

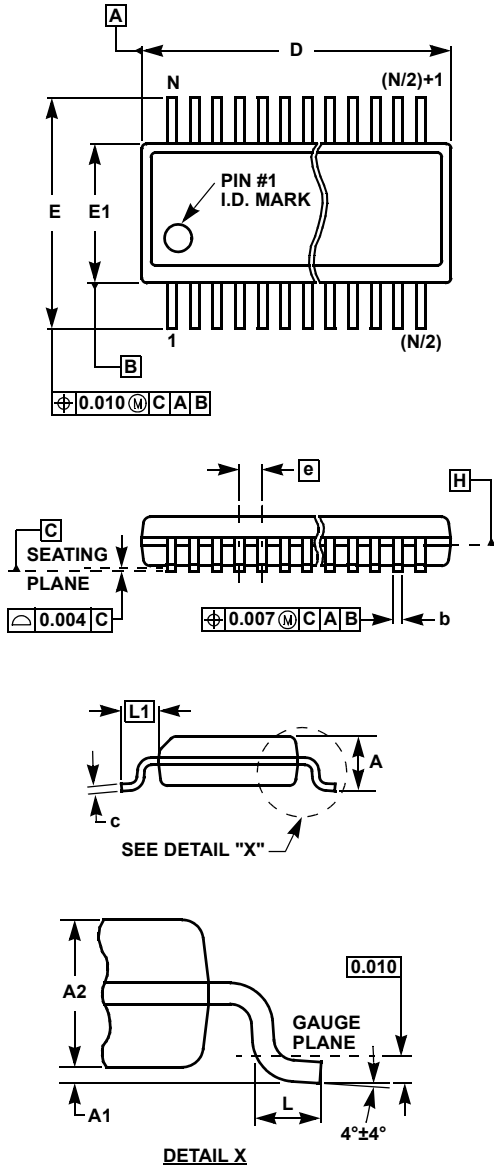

MDP0040

QUARTER SIZE OUTLINE PLASTIC PACKAGES FAMILY

SYMBOL	INCHES			TOLERANCE	NOTES
	QSOP16	QSOP24	QSOP28		
A	0.068	0.068	0.068	Max.	-
A1	0.006	0.006	0.006	± 0.002	-
A2	0.056	0.056	0.056	± 0.004	-
b	0.010	0.010	0.010	± 0.002	-
c	0.008	0.008	0.008	± 0.001	-
D	0.193	0.341	0.390	± 0.004	1, 3
E	0.236	0.236	0.236	± 0.008	-
E1	0.154	0.154	0.154	± 0.004	2, 3
e	0.025	0.025	0.025	Basic	-
L	0.025	0.025	0.025	± 0.009	-
L1	0.041	0.041	0.041	Basic	-
N	16	24	28	Reference	-

Rev. F 2/07

NOTES:

1. Plastic or metal protrusions of 0.006" maximum per side are not included.
2. Plastic interlead protrusions of 0.010" maximum per side are not included.
3. Dimensions "D" and "E1" are measured at Datum Plane "H".
4. Dimensioning and tolerancing per ASME Y14.5M-1994.

Small Outline Transistor Plastic Packages (SC70-5)

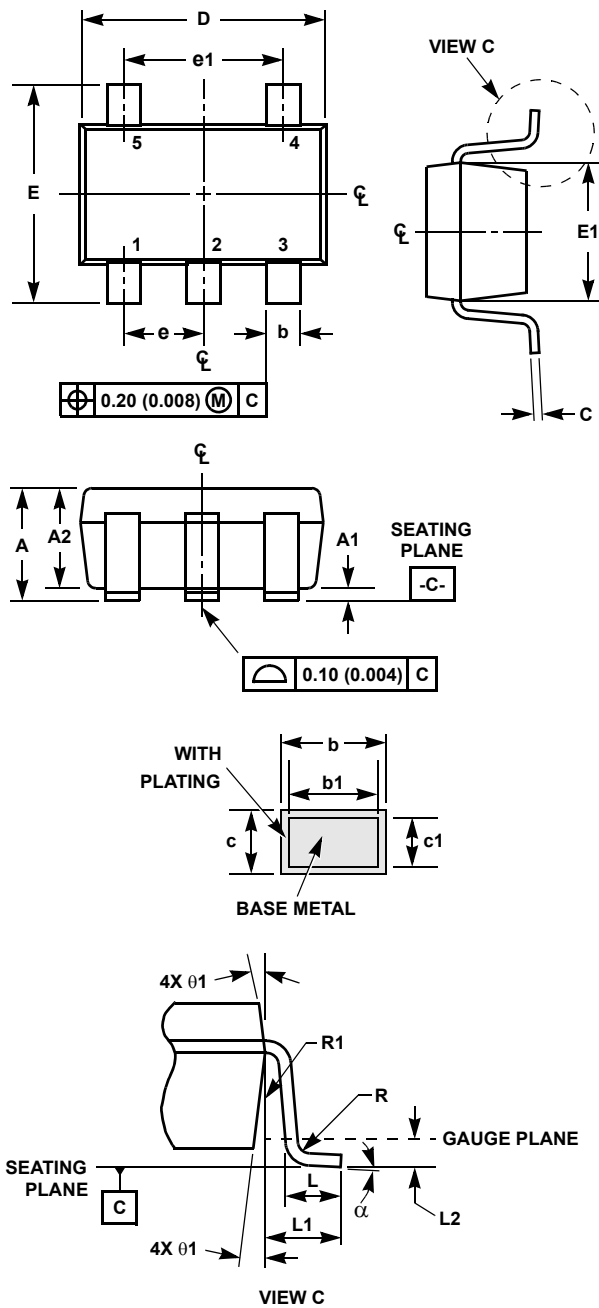

P5.049

5 LEAD SMALL OUTLINE TRANSISTOR PLASTIC PACKAGE

SYMBOL	INCHES		MILLIMETERS		NOTES
	MIN	MAX	MIN	MAX	
A	0.031	0.043	0.80	1.10	-
A1	0.000	0.004	0.00	0.10	-
A2	0.031	0.039	0.80	1.00	-
b	0.006	0.012	0.15	0.30	-
b1	0.006	0.010	0.15	0.25	-
c	0.003	0.009	0.08	0.22	6
c1	0.003	0.009	0.08	0.20	6
D	0.073	0.085	1.85	2.15	3
E	0.071	0.094	1.80	2.40	-
E1	0.045	0.053	1.15	1.35	3
e	0.0256 Ref		0.65 Ref		-
e1	0.0512 Ref		1.30 Ref		-
L	0.010	0.018	0.26	0.46	4
L1	0.017 Ref.		0.420 Ref.		-
L2	0.006 BSC		0.15 BSC		-
α	0°	8°	0°	8°	-
N	5		5		5
R	0.004	-	0.10	-	-
R1	0.004	0.010	0.15	0.25	-

Rev. 2 9/03

NOTES:

1. Dimensioning and tolerances per ASME Y14.5M-1994.
2. Package conforms to EIAJ SC70 and JEDEC MO-203AA.
3. Dimensions D and E1 are exclusive of mold flash, protrusions, or gate burrs.
4. Footlength L measured at reference to gauge plane.
5. "N" is the number of terminal positions.
6. These Dimensions apply to the flat section of the lead between 0.08mm and 0.15mm from the lead tip.
7. Controlling dimension: MILLIMETER. Converted inch dimensions are for reference only.

Компания «Life Electronics» занимается поставками электронных компонентов импортного и отечественного производства от производителей и со складов крупных дистрибьюторов Европы, Америки и Азии.

С конца 2013 года компания активно расширяет линейку поставок компонентов по направлению коаксиальный кабель, кварцевые генераторы и конденсаторы (керамические, пленочные, электролитические), за счёт заключения дистрибьюторских договоров

Мы предлагаем:

- Конкурентоспособные цены и скидки постоянным клиентам.
- Специальные условия для постоянных клиентов.
- Подбор аналогов.
- Поставку компонентов в любых объемах, удовлетворяющих вашим потребностям.
- Приемлемые сроки поставки, возможна ускоренная поставка.
- Доставку товара в любую точку России и стран СНГ.
- Комплексную поставку.
- Работу по проектам и поставку образцов.
- Формирование склада под заказчика.
- Сертификаты соответствия на поставляемую продукцию (по желанию клиента).
- Тестирование поставляемой продукции.
- Поставку компонентов, требующих военную и космическую приемку.
- Входной контроль качества.
- Наличие сертификата ISO.

В составе нашей компании организован Конструкторский отдел, призванный помогать разработчикам, и инженерам.

Конструкторский отдел помогает осуществить:

- Регистрацию проекта у производителя компонентов.
- Техническую поддержку проекта.
- Защиту от снятия компонента с производства.
- Оценку стоимости проекта по компонентам.
- Изготовление тестовой платы монтаж и пусконаладочные работы.



Тел: +7 (812) 336 43 04 (многоканальный)
Email: org@lifeelectronics.ru