

MTP PressFit Power Module Three Phase Bridge, 45 A to 100 A



MTP PressFit

FEATURES

- Low V_F
- Low profile package
- Direct mounting to heatsink
- PressFit pins technology
- Low junction to case thermal resistance
- 3500 V_{RMS} insulation voltage
- UL approved file E78996
- Designed and qualified for industrial level
- Material categorization: For definitions of compliance please see www.vishay.com/doc?99912

**RoHS
COMPLIANT**

APPLICATIONS

- Power conversion machines
- Welding
- UPS
- SMPS
- Motor drives
- General purpose and heavy duty application

DESCRIPTION

The new MTP module is easy to use thanks to solder less method for contacting PressFit pins to the PCB. The low profile package has been specifically conceived to maximize space saving and optimize the electrical layout of the application specific power supplies.

PRODUCT SUMMARY

I_o	45 A to 100 A
V_{RRM}	1600 V
Package	MTP PressFit
Circuit	Three phase bridge

MAJOR RATINGS AND CHARACTERISTICS

SYMBOL	CHARACTERISTICS	VALUES 40MT	VALUES 70MT	VALUES 100MT	UNITS
I_o		45	75	100	A
	T_C	100	80	80	°C
I_{FSM}	50 Hz	270	380	450	A
	60 Hz	280	398	470	
I^2t	50 Hz	365	724	1013	A ² s
	60 Hz	325	660	920	
$I^2\sqrt{t}$		3650	7240	10 130	A ² √s
V_{RRM}		1600			V
T_{Stg}	Range	-40 to +125			°C
T_J		-40 to +150			

ELECTRICAL SPECIFICATIONS

VOLTAGE RATINGS

TYPE NUMBER	VOLTAGE CODE REVERSE VOLTAGE V	V_{RRM} , MAXIMUM REPETITIVE PEAK REVERSE VOLTAGE V	V_{RSM} , MAXIMUM NON-REPETITIVE PEAK V	I_{RRM} MAXIMUM AT $T_J = 150\text{ °C}$ mA
VS-40MT160P-P, VS-70MT160P-P, VS-100MT160P-P	160	1600	1700	5



FORWARD CONDUCTION								
PARAMETER	SYMBOL	TEST CONDITIONS		VALUE 40MT	VALUES 70MT	VALUES 100MT	UNITS	
Maximum DC output current at case temperature	I _o	120° rect. to conduction angle		45	75	100	A	
				100	80	80	°C	
Maximum peak, one cycle forward, non-repetitive on state surge current	I _{FSM}	t = 10 ms	No voltage reapplied	Initial T _J = T _J maximum	270	380	450	A
		t = 8.3 ms			280	398	470	
		t = 10 ms	100 % V _{RRM} reapplied		225	320	380	
		t = 8.3 ms			240	335	400	
Maximum I ² t for fusing	I ² t	t = 10 ms	No voltage reapplied	Initial T _J = T _J maximum	365	724	1013	A ² s
		t = 8.3 ms			325	660	920	
		t = 10 ms	100 % V _{RRM} reapplied		253	512	600	
		t = 8.3 ms			240	467	665	
Maximum I ² √t for fusing	I ² √t	t = 0.1 ms to 10 ms, no voltage reapplied		3650	7240	10 130	A ² √s	
Value of threshold voltage	V _{F(TO)}	T _J maximum		0.78	0.82	0.75	V	
Slope resistance	r _t			14.8	9.5	8.1	mΩ	
Maximum forward voltage drop	V _{FM}	T _J = 25 °C; t _p = 400 μs single junction (40MT, I _{pk} = 40 A) (70MT, I _{pk} = 70 A) (100MT, I _{pk} = 100 A)		1.45	1.45	1.51	V	

INSULATION TABLE						
PARAMETER	SYMBOL	TEST CONDITIONS	40MT	70MT	100MT	UNITS
RMS insulation voltage	V _{INS}	T _J = 25 °C, all terminal shorted, f = 50 Hz, t = 1 s	3500			V

THERMAL AND MECHANICAL SPECIFICATIONS						
PARAMETER	SYMBOL	TEST CONDITIONS	40MT	70MT	100MT	UNITS
Maximum junction operating temperature range	T _J		- 40 to 150			°C
Maximum storage temperature range	T _{Stg}		- 40 to 125			
Maximum thermal resistance, junction to case	R _{thJC}	DC operation per module	0.27	0.23	0.19	K/W
		DC operation per junction	1.6	1.38	1.14	
		120° rect. conduction angle per module	0.38	0.29	0.22	
		120° rect. conduction angle per junction	2.25	1.76	1.29	
Maximum thermal resistance, case to heatsink per module	R _{thCS}	Mounting surface smooth, flat and greased Heatsink compound thermal conductivity = 0.42 W/mK	0.1			
Mounting torque to heatsink ± 10 %		A mounting compound is recommended and the torque should be rechecked after a period of 3 hours to allow for the spread of the compound. Lubricated threads	4			Nm
Approximate weight			65			g

CLEARANCE AND CREEPAGE DISTANCES			
PARAMETER	TEST CONDITIONS	MTP PressFit	UNITS
Clearance	External shortest distances in air between terminals which are not internally short circuited together	10.2	mm
Creepage distance	Shortest distance along external surface of the insulating material between terminals which are not internally short circuited together	13	

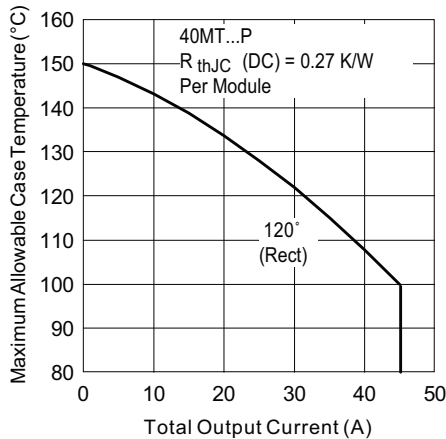

Fig. 1 - Current Rating Characteristics

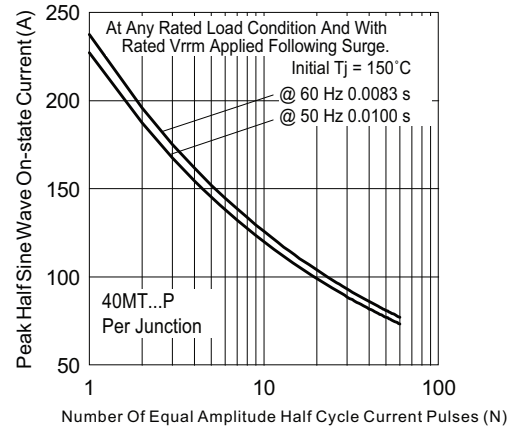

Fig. 3 - Maximum Non-Repetitive Surge Current

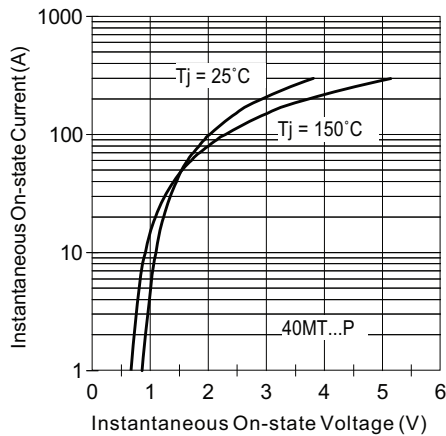

Fig. 2 - On-State Voltage Drop Characteristics

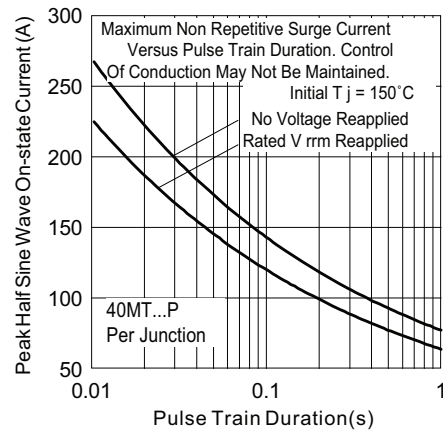

Fig. 4 - Maximum Non-Repetitive Surge Current

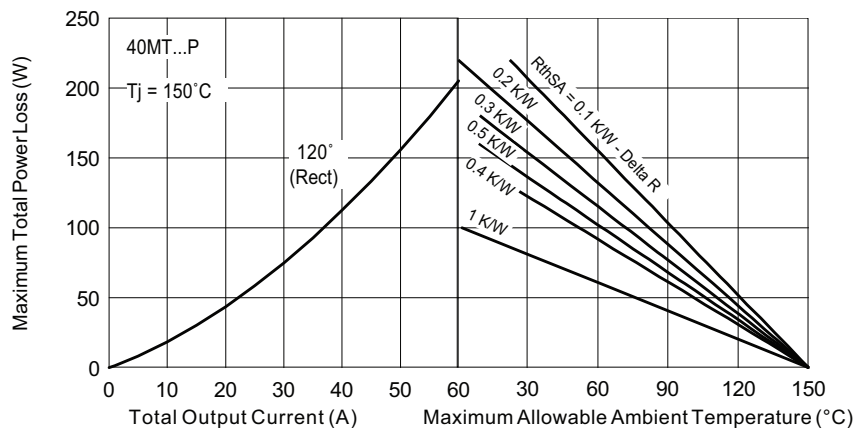

Fig. 5 - Current Rating Nomogram (1 Module Per Heatsink)

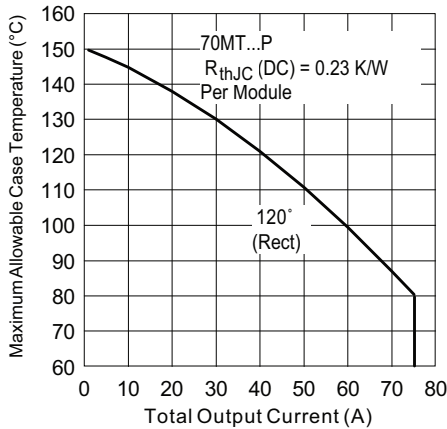

Fig. 6 - Current Rating Characteristics

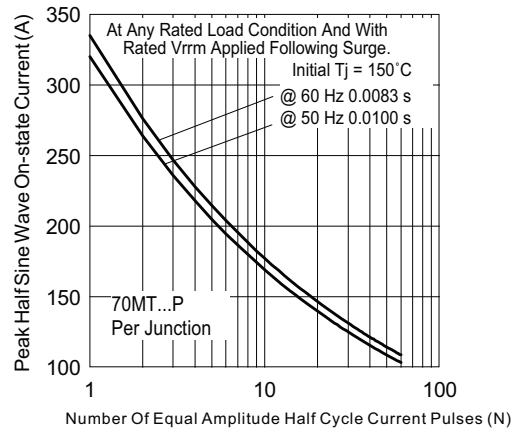

Fig. 8 - Maximum Non-Repetitive Surge Current

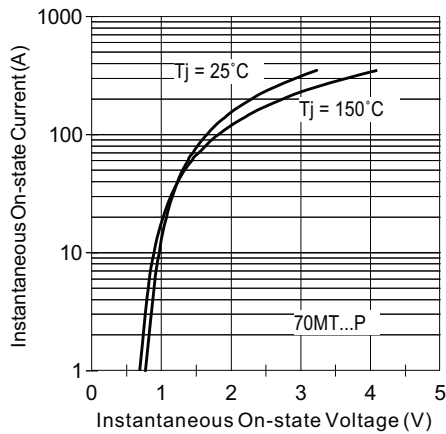

Fig. 7 - On-State Voltage Drop Characteristics

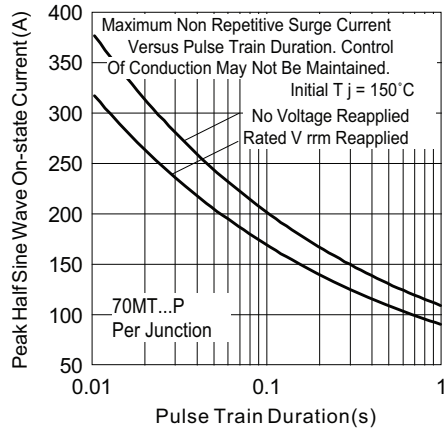

Fig. 9 - Maximum Non-Repetitive Surge Current

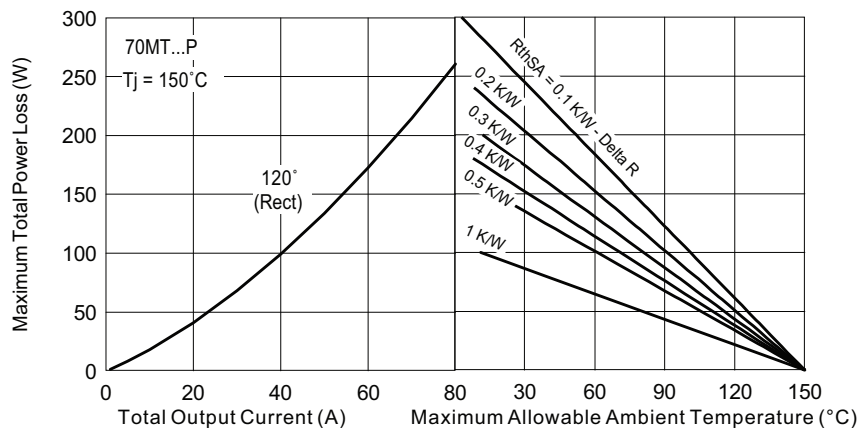

Fig. 10 - Current Rating Nomogram (1 Module Per Heatsink)

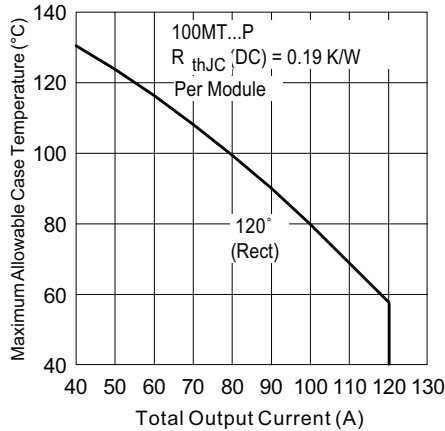

Fig. 11 - Current Rating Characteristics

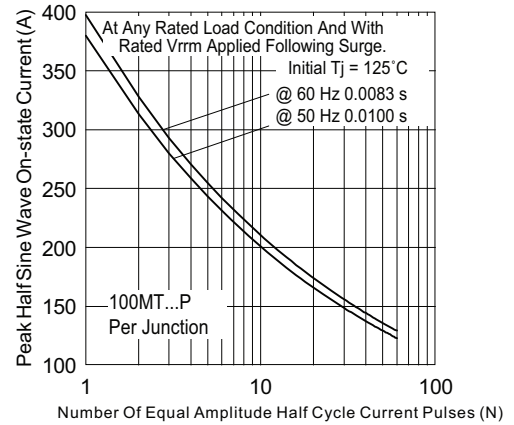

Fig. 13 - Maximum Non-Repetitive Surge Current

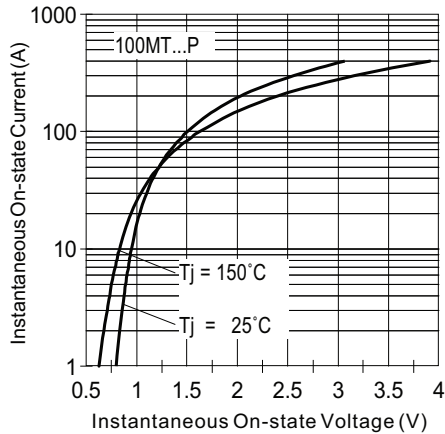

Fig. 12 - On-State Voltage Drop Characteristics

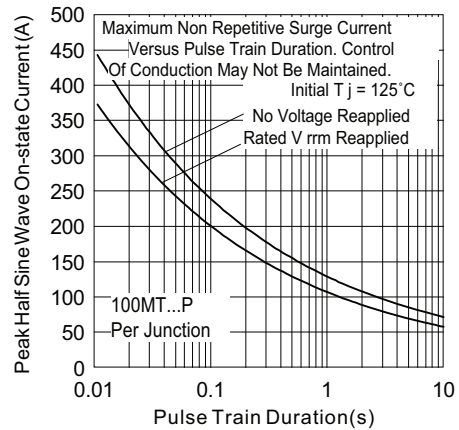

Fig. 14 - Maximum Non-Repetitive Surge Current

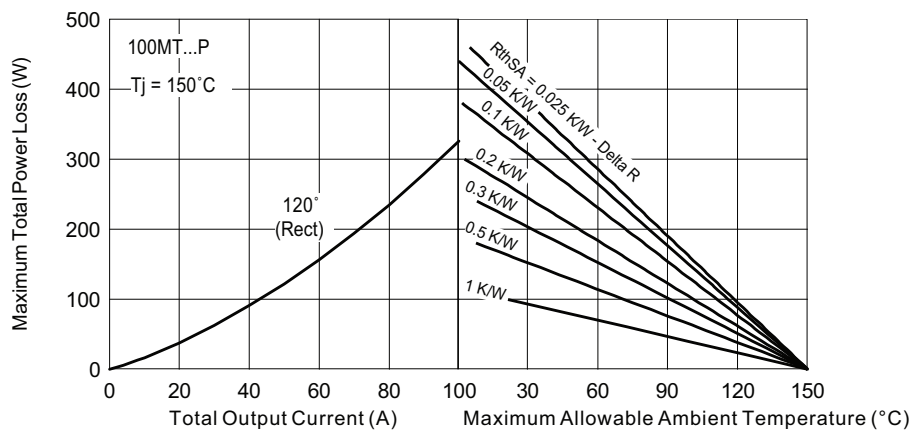
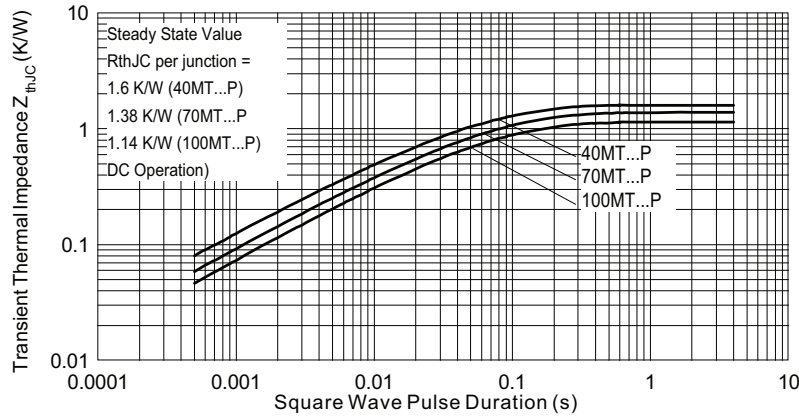

Fig. 15 - Current Rating Nomogram (1 Module Per Heatsink)

 Fig. 16 - Thermal Impedance Z_{thJC} Characteristics

ORDERING INFORMATION TABLE

Device code	VS-	10	0	MT	160	P	-P
	①	②	③	④	⑤	⑥	
	1	2	3	4	5	6	
				4 = 45 A 7 = 75 A 10 = 100 A			
			3 = 0 = Three Phase Bridge				
			4 = Package indicator				
			5 = Voltage code x 10 = V_{RRM} (see Voltage Ratings table)				
			6 = Pinout code (PressFit pins)				

CIRCUIT CONFIGURATION

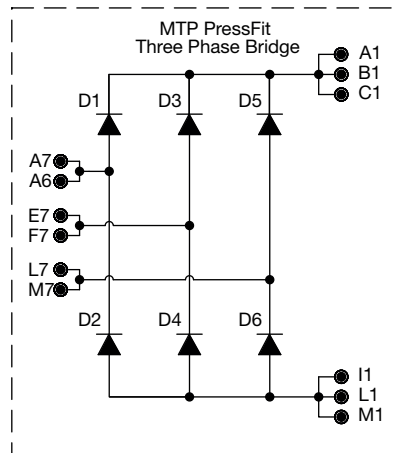

LINKS TO RELATED DOCUMENTS

Dimensions

www.vishay.com/doc?95595

MTP PressFit

DIMENSIONS in millimeters

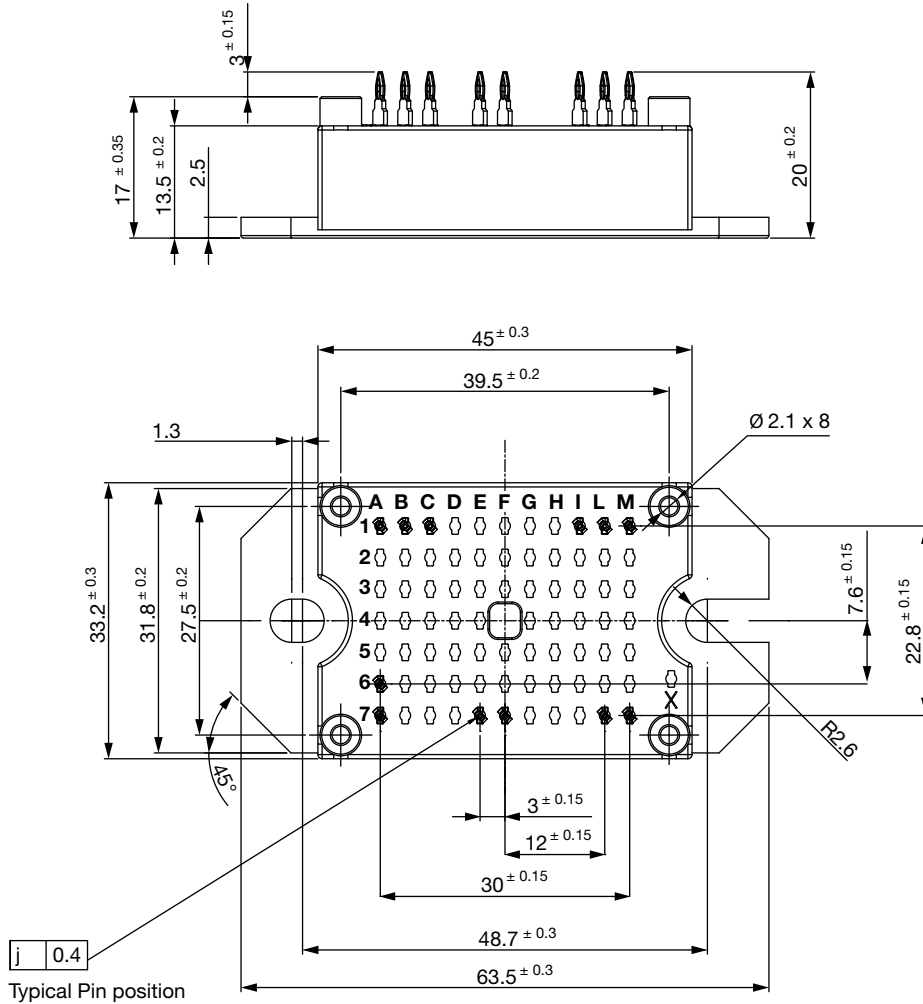



MTP Three Phase PressFit

DIMENSIONS in millimeters

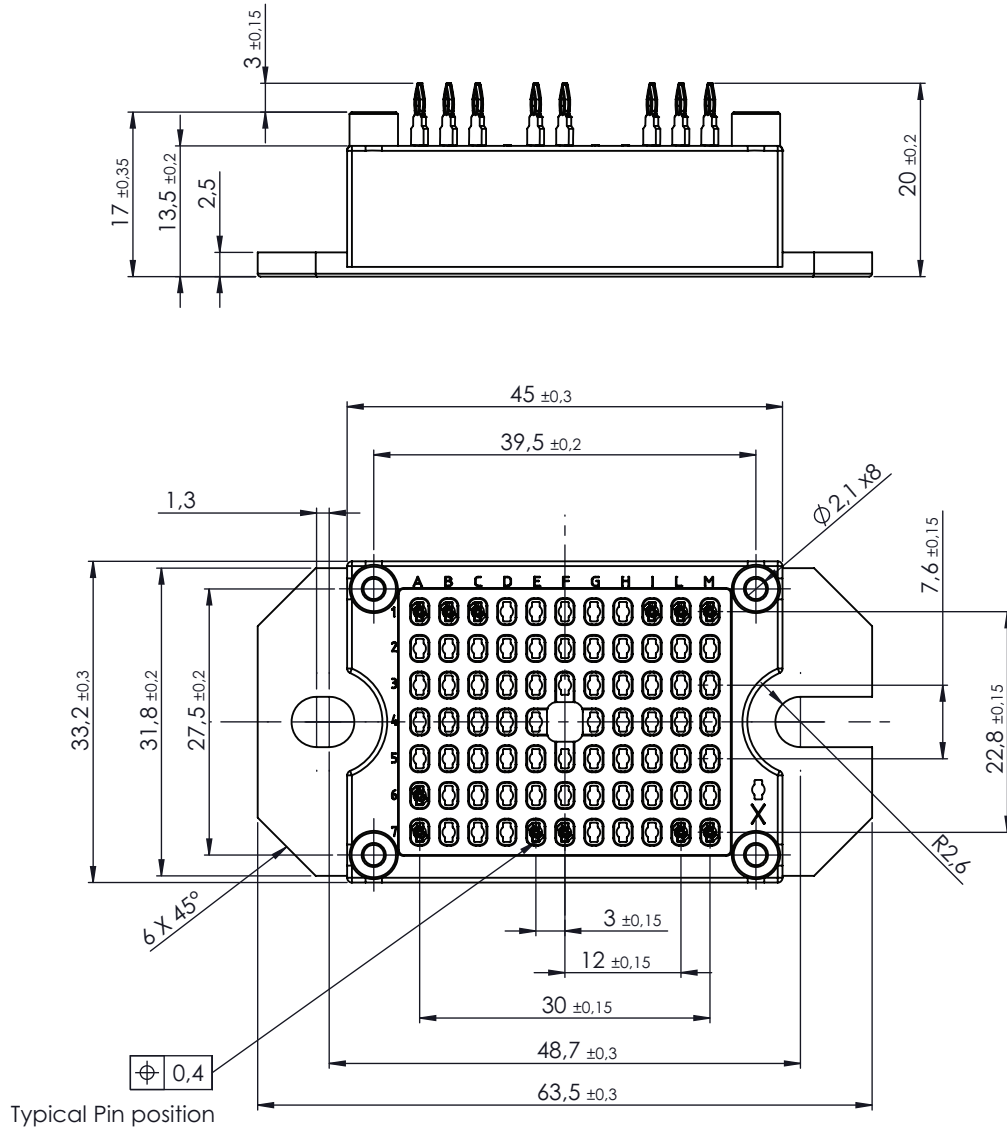



Disclaimer

ALL PRODUCT, PRODUCT SPECIFICATIONS AND DATA ARE SUBJECT TO CHANGE WITHOUT NOTICE TO IMPROVE RELIABILITY, FUNCTION OR DESIGN OR OTHERWISE.

Vishay Intertechnology, Inc., its affiliates, agents, and employees, and all persons acting on its or their behalf (collectively, "Vishay"), disclaim any and all liability for any errors, inaccuracies or incompleteness contained in any datasheet or in any other disclosure relating to any product.

Vishay makes no warranty, representation or guarantee regarding the suitability of the products for any particular purpose or the continuing production of any product. To the maximum extent permitted by applicable law, Vishay disclaims (i) any and all liability arising out of the application or use of any product, (ii) any and all liability, including without limitation special, consequential or incidental damages, and (iii) any and all implied warranties, including warranties of fitness for particular purpose, non-infringement and merchantability.

Statements regarding the suitability of products for certain types of applications are based on Vishay's knowledge of typical requirements that are often placed on Vishay products in generic applications. Such statements are not binding statements about the suitability of products for a particular application. It is the customer's responsibility to validate that a particular product with the properties described in the product specification is suitable for use in a particular application. Parameters provided in datasheets and/or specifications may vary in different applications and performance may vary over time. All operating parameters, including typical parameters, must be validated for each customer application by the customer's technical experts. Product specifications do not expand or otherwise modify Vishay's terms and conditions of purchase, including but not limited to the warranty expressed therein.

Except as expressly indicated in writing, Vishay products are not designed for use in medical, life-saving, or life-sustaining applications or for any other application in which the failure of the Vishay product could result in personal injury or death. Customers using or selling Vishay products not expressly indicated for use in such applications do so at their own risk. Please contact authorized Vishay personnel to obtain written terms and conditions regarding products designed for such applications.

No license, express or implied, by estoppel or otherwise, to any intellectual property rights is granted by this document or by any conduct of Vishay. Product names and markings noted herein may be trademarks of their respective owners.

Material Category Policy

Vishay Intertechnology, Inc. hereby certifies that all its products that are identified as RoHS-Compliant fulfill the definitions and restrictions defined under Directive 2011/65/EU of The European Parliament and of the Council of June 8, 2011 on the restriction of the use of certain hazardous substances in electrical and electronic equipment (EEE) - recast, unless otherwise specified as non-compliant.

Please note that some Vishay documentation may still make reference to RoHS Directive 2002/95/EC. We confirm that all the products identified as being compliant to Directive 2002/95/EC conform to Directive 2011/65/EU.

Vishay Intertechnology, Inc. hereby certifies that all its products that are identified as Halogen-Free follow Halogen-Free requirements as per JEDEC JS709A standards. Please note that some Vishay documentation may still make reference to the IEC 61249-2-21 definition. We confirm that all the products identified as being compliant to IEC 61249-2-21 conform to JEDEC JS709A standards.

Компания «Life Electronics» занимается поставками электронных компонентов импортного и отечественного производства от производителей и со складов крупных дистрибьюторов Европы, Америки и Азии.

С конца 2013 года компания активно расширяет линейку поставок компонентов по направлению коаксиальный кабель, кварцевые генераторы и конденсаторы (керамические, пленочные, электролитические), за счёт заключения дистрибьюторских договоров

Мы предлагаем:

- Конкурентоспособные цены и скидки постоянным клиентам.
- Специальные условия для постоянных клиентов.
- Подбор аналогов.
- Поставку компонентов в любых объемах, удовлетворяющих вашим потребностям.
- Приемлемые сроки поставки, возможна ускоренная поставка.
- Доставку товара в любую точку России и стран СНГ.
- Комплексную поставку.
- Работу по проектам и поставку образцов.
- Формирование склада под заказчика.
- Сертификаты соответствия на поставляемую продукцию (по желанию клиента).
- Тестирование поставляемой продукции.
- Поставку компонентов, требующих военную и космическую приемку.
- Входной контроль качества.
- Наличие сертификата ISO.

В составе нашей компании организован Конструкторский отдел, призванный помогать разработчикам, и инженерам.

Конструкторский отдел помогает осуществить:

- Регистрацию проекта у производителя компонентов.
- Техническую поддержку проекта.
- Защиту от снятия компонента с производства.
- Оценку стоимости проекта по компонентам.
- Изготовление тестовой платы монтаж и пусконаладочные работы.



Тел: +7 (812) 336 43 04 (многоканальный)

Email: org@lifeelectronics.ru