

## ANGELETTE-S-B-PLAIN

~10° spot beam. Clean appearance with no additional attachment interface and compatible with BJB connectors.

### TECHNICAL SPECIFICATIONS:

Dimensions	Ø 110.0 mm
Height	57.3 mm
Fastening	socket
ROHS compliant	yes ⓘ

### MATERIAL SPECIFICATIONS:

Component	Type	Material	Colour	Finish	Coating
ANGELETTE-S-B-PLAIN	Reflector	PC	metal		HMDS

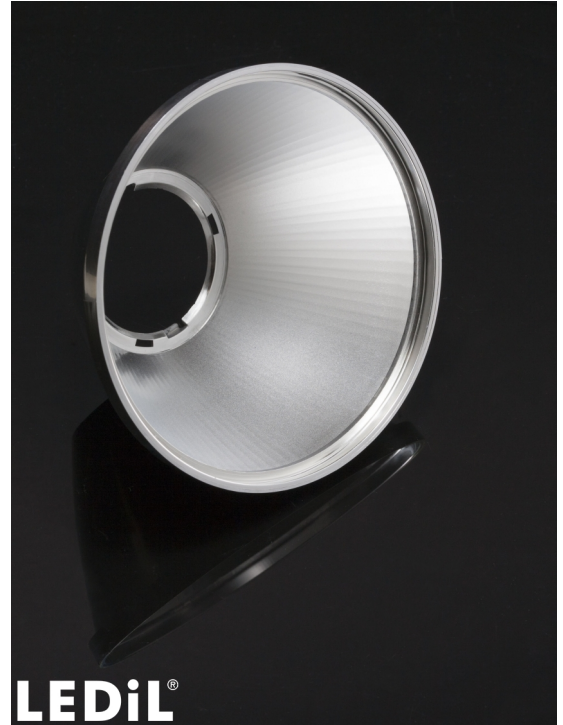



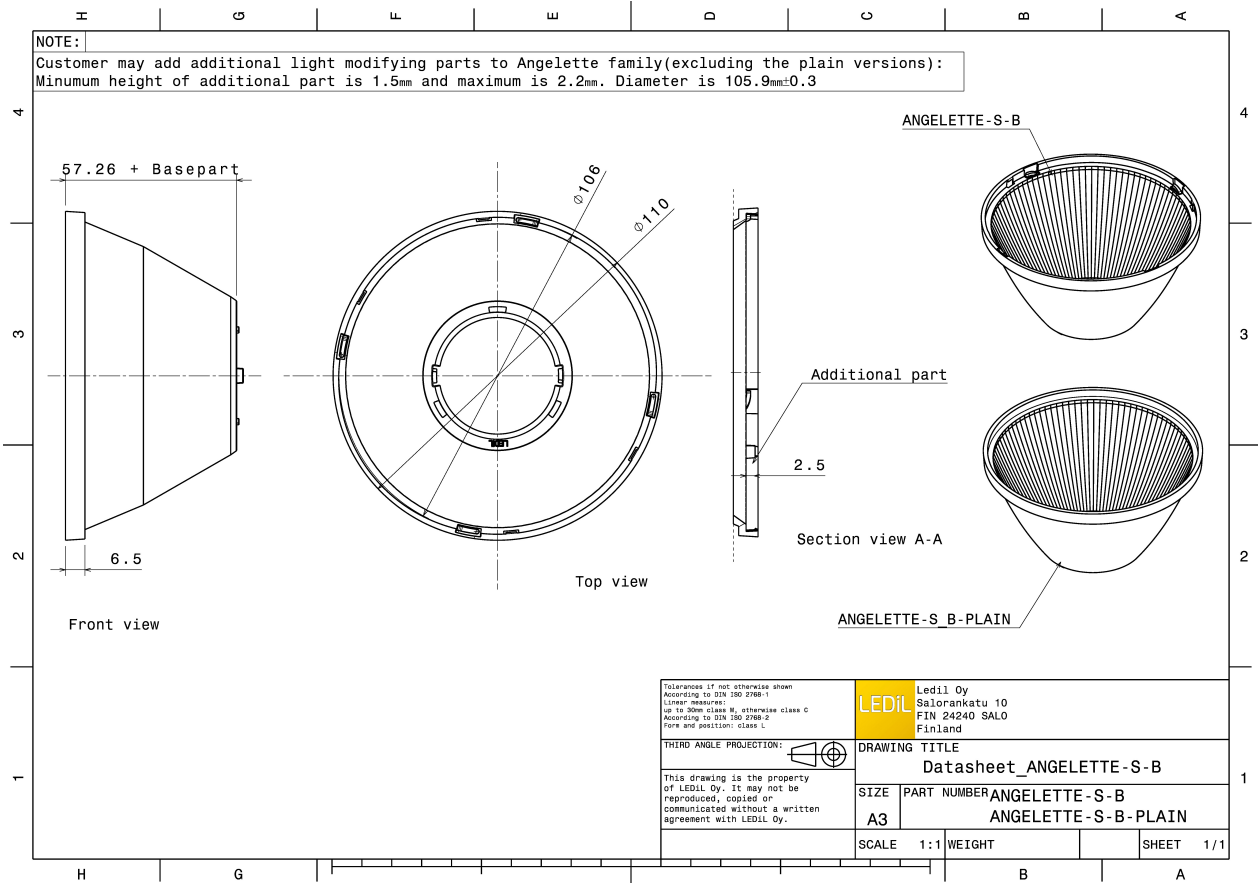

### ORDERING INFORMATION:

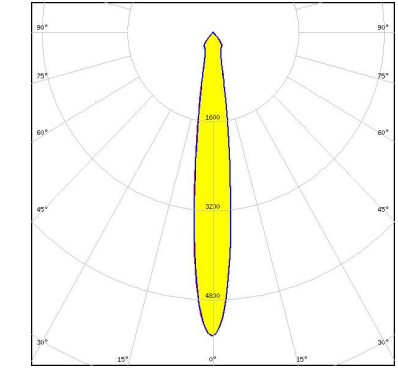

Component	Qty in box	MOQ	MPQ	Box weight (kg)
F14624_ANGELETTE-S-B-PLAIN » Box size: 398 x 298 x 265 mm	180	90	45	7.6

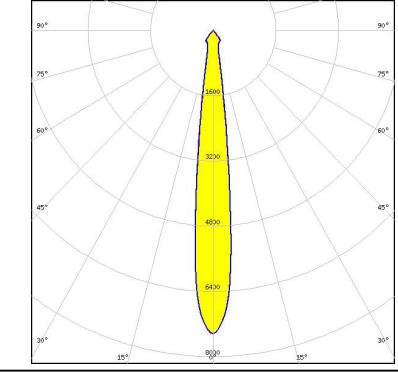
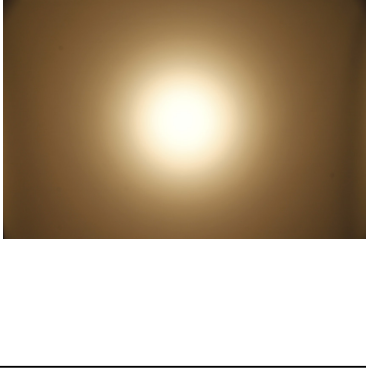
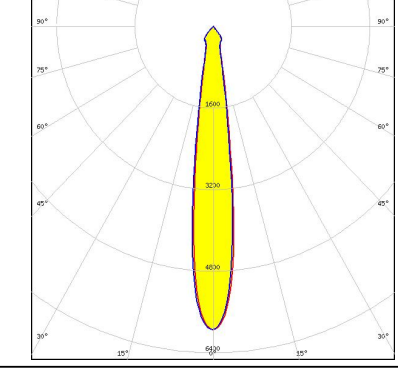

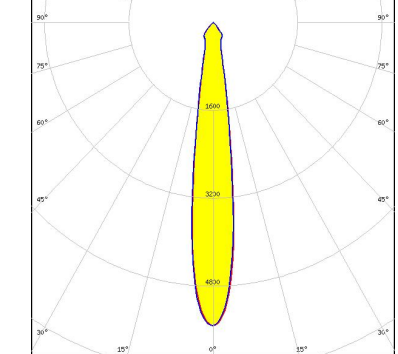
#### PHOTOMETRIC DATA (MEASURED):

<p>bridgelux.</p> <p>LED V15 Gen6            FWHM 14.0°            Efficiency 87 %            Peak intensity 5.4 cd/lm            LEDs/each optic 1            Light colour White            Required components:            F13671_ANGE-RZ-LENS            BJB: 47.319.2224</p>		
<p>bridgelux.</p> <p>LED V15 Gen6            FWHM 13.0°            Efficiency 91 %            Peak intensity 7.4 cd/lm            LEDs/each optic 1            Light colour White            Required components:            BJB: 47.319.2224</p>		
<p>bridgelux.</p> <p>LED V18 Gen6            FWHM 15.0°            Efficiency 91 %            Peak intensity 6 cd/lm            LEDs/each optic 1            Light colour White            Required components:            BJB: 47.319.2274</p>		
<p>bridgelux.</p> <p>LED V18 Gen7            FWHM 15.0°            Efficiency 91 %            Peak intensity 5.5 cd/lm            LEDs/each optic 1            Light colour White            Required components:            BJB: 47.319.2350</p>		

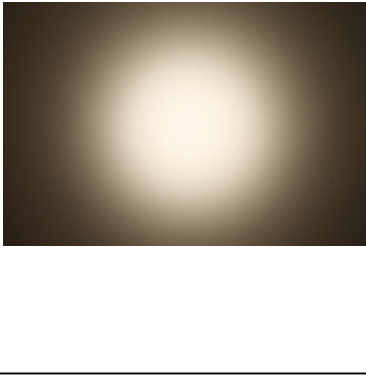
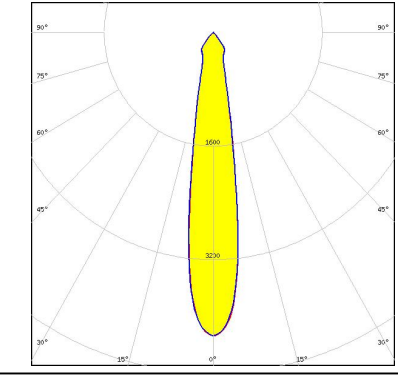
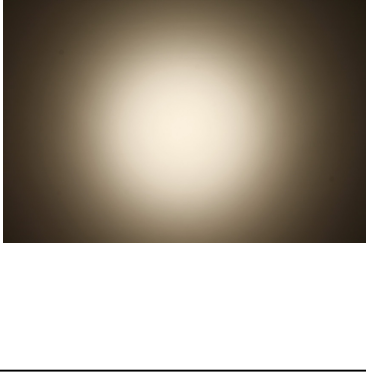
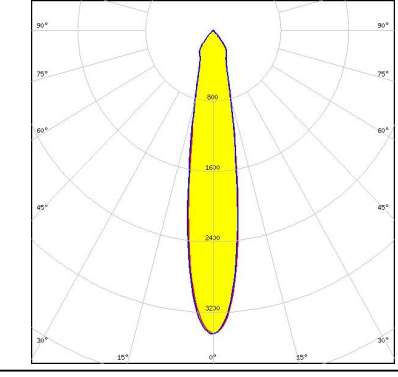
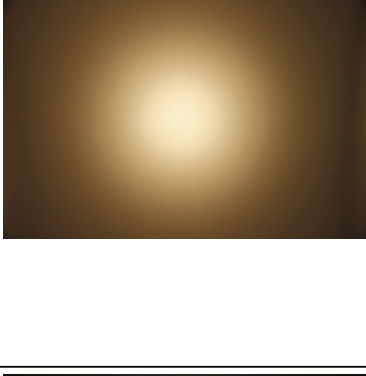
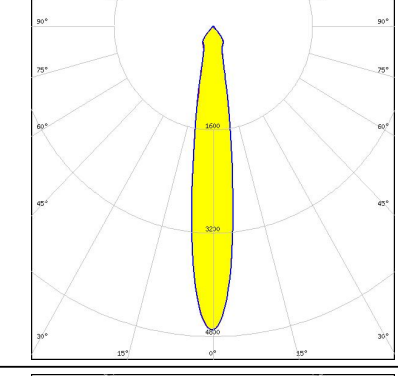
#### PHOTOMETRIC DATA (MEASURED):

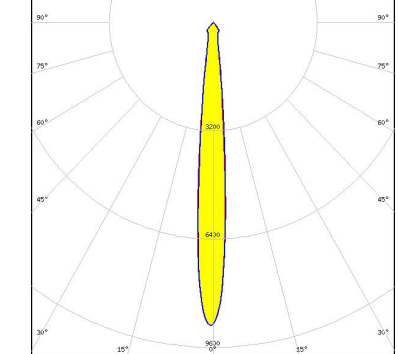
<p>bridgelux.</p> <p>LED V22 Gen6            FWHM 18.0°            Efficiency 89 %            Peak intensity 4.3 cd/lm            LEDs/each optic 1            Light colour White            Required components:            A.A.G. STUCCHI: 8102/G2</p>		
<p>bridgelux.</p> <p>LED V22 Gen6            FWHM 19.0°            Efficiency 85 %            Peak intensity 3.4 cd/lm            LEDs/each optic 1            Light colour White            Required components:            F13671_ANGE-RZ-LENS            A.A.G. STUCCHI: 8102/G2</p>		
<p>bridgelux.</p> <p>LED V22 Gen6            FWHM 16.0°            Efficiency 88 %            Peak intensity 4.7 cd/lm            LEDs/each optic 1            Light colour White            Required components:            F13671_ANGE-RZ-LENS            BJB: 47.319.2274</p>		
<p><b>CREE</b> </p> <p>LED CXA/B 1816 &amp; CXA/B 1820 &amp; CXA 1850            FWHM 10.0°            Efficiency 90 %            Peak intensity 9 cd/lm            LEDs/each optic 1            Light colour White            Required components:</p>		

#### PHOTOMETRIC DATA (MEASURED):

#### LUMILEDS

LED LUXEON CoB 1208  
 FWHM 14.0°  
 Efficiency 87 %  
 Peak intensity 5.6 cd/lm  
 LEDs/each optic 1  
 Light colour White  
 Required components:  
 F13671\_ANGE-RZ-LENS  
 A.A.G. STUCCHI: 8301/G2

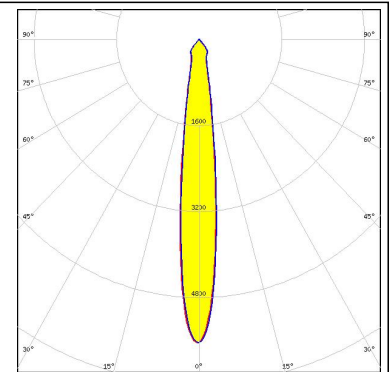

#### LUMILEDS

LED LUXEON CoB 1208  
 FWHM 12.0°  
 Efficiency 91 %  
 Peak intensity 7.8 cd/lm  
 LEDs/each optic 1  
 Light colour White  
 Required components:  
 A.A.G. STUCCHI: 8301/G2

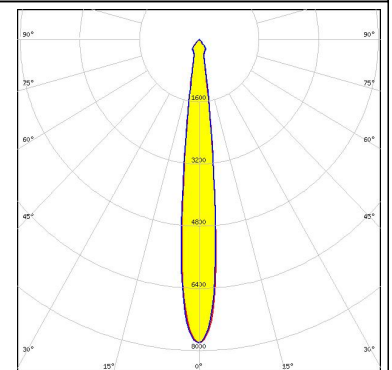

#### SAMSUNG

LED LC016D / LC019D / LC026D / LC033D  
 FWHM 12.0°  
 Efficiency 91 %  
 Peak intensity 7.7 cd/lm  
 LEDs/each optic 1  
 Light colour White  
 Required components:  
 A.A.G. STUCCHI: 8101/G2

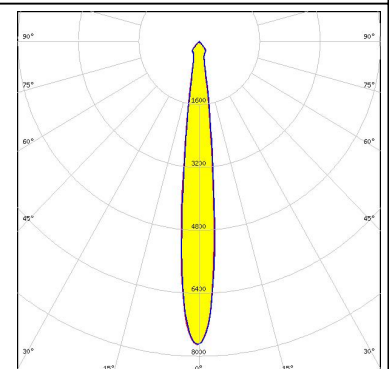
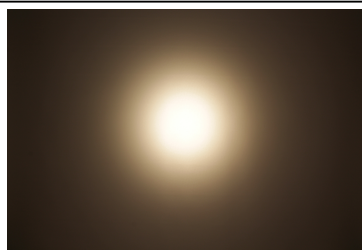

#### SAMSUNG

LED LC016D / LC019D / LC026D / LC033D  
 FWHM 14.0°  
 Efficiency 88 %  
 Peak intensity 5.7 cd/lm  
 LEDs/each optic 1  
 Light colour White  
 Required components:  
 F13671\_ANGE-RZ-LENS  
 BJB: 47.319.2021

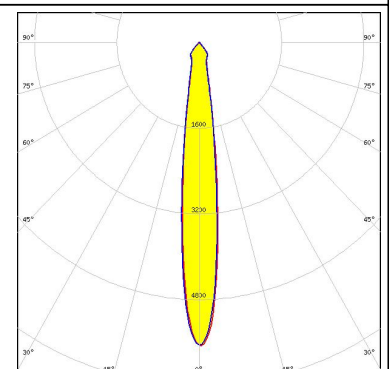
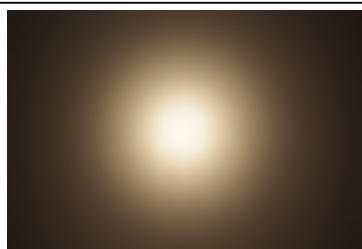

#### PHOTOMETRIC DATA (MEASURED):

#### SAMSUNG

LED LC016D / LC019D / LC026D / LC033D  
 FWHM 14.0°  
 Efficiency 88 %  
 Peak intensity 5.7 cd/lm  
 LEDs/each optic 1  
 Light colour White  
 Required components:  
 F13671\_ANGE-RZ-LENS  
 A.A.G. STUCCHI: 8101/G2

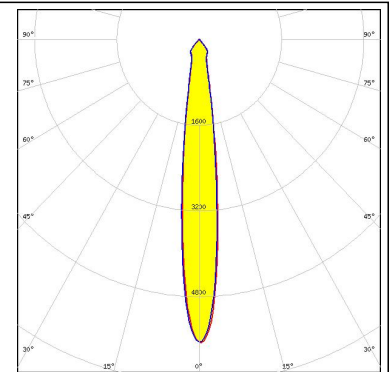

#### SAMSUNG

LED LC016D / LC019D / LC026D / LC033D  
 FWHM 12.0°  
 Efficiency 91 %  
 Peak intensity 7.7 cd/lm  
 LEDs/each optic 1  
 Light colour White  
 Required components:  
 BJB: 47.319.2021

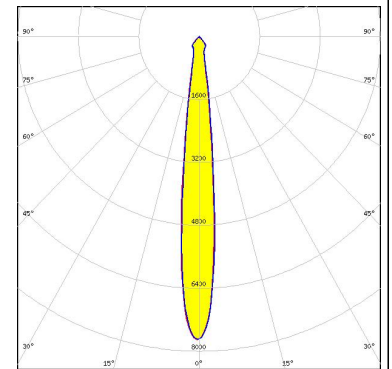

SEOUL SEMICONDUCTOR

LED AC Zhaga COB  
 FWHM 12.0°  
 Efficiency 90 %  
 Peak intensity 7.7 cd/lm  
 LEDs/each optic 1  
 Light colour White  
 Required components:

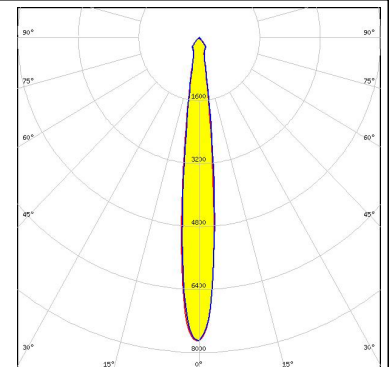
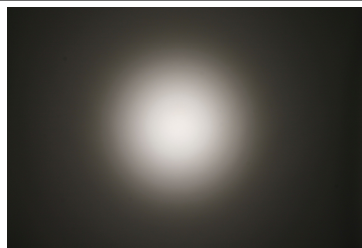

#### XICATO

LED XTM - 19mm LES  
 FWHM 14.0°  
 Efficiency 92 %  
 Peak intensity 6.6 cd/lm  
 LEDs/each optic 1  
 Light colour White  
 Required components:  
 C15743\_XTM-ADAPTER-50-B

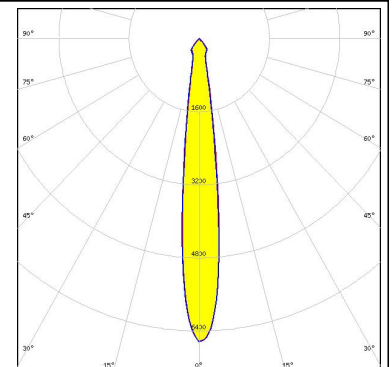
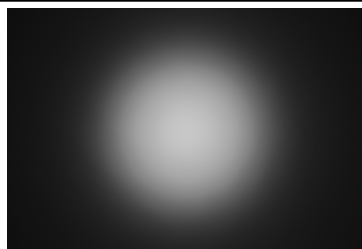

#### PHOTOMETRIC DATA (SIMULATED):

#### CITIZEN

LED CLL03x/CLU03x  
FWHM 12.0°  
Efficiency 94 %  
Peak intensity 11.2 cd/lm  
LEDs/each optic 1  
Light colour White  
Required components:  
BJB: 47.319.2021

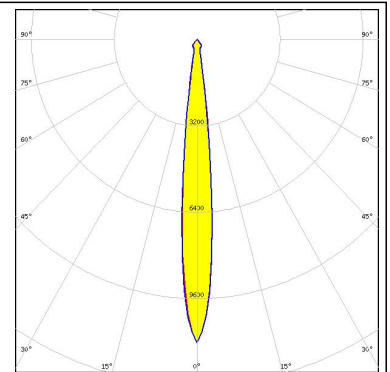

#### SAMSUNG

LED LC040D / LC060D / LC080D  
FWHM 18.0°  
Efficiency 88 %  
Peak intensity 4.5 cd/lm  
LEDs/each optic 1  
Light colour White  
Required components:  
BJB: 47.319.2030

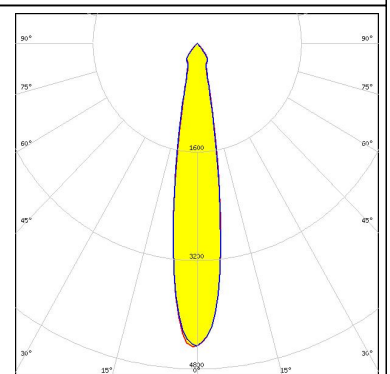

#### GENERAL INFORMATION:

NOTE: The typical beam angle will be changed by different color, chip size and chip position tolerance. The typical total beam angle is the full angle measured where the luminous intensity is half of the peak value.

Due to use of high power COB's with this product, special attention to proper thermal design is highly recommended. LEDiL has no liability for direct, indirect or consecutive damages arising from the LEDiL products being used outside of the recommended temperature range.

#### MATERIALS:

As part of our continuous research and improvement processes, and to ensure the best possible quality and availability of our products, LEDiL reserves the right to change material grades without notice.

#### PRODUCT DATA USER AGREEMENT AND DISCLAIMER:

The measured data in the provided downloadable LEDiL Product Datasheets and Mechanical 2D-Drawings is rounded and provided as reference for planning. LEDiL Oy's optical specifications have been verified by conducting performance testing of the products in accordance with the company's quality system. The reported data are averaged results of multiple measurements with typical variation. LEDiL Oy reserves the right to without prior notification make changes and improvements to its products.

LEDiL Oy assumes neither warranty, nor guarantee nor any other liability of any kind for the contents and correctness of the provided data. The provided data has been generated with highest diligence but the provided data may in reality not represent the complete possible variation range of all intrinsic parameters. Therefore, in certain cases a deviation from the provided data could occur.

LEDiL Oy reserves the right to undertake technical changes of its products without further notification which could lead to changes in the provided data. LEDiL Oy assumes no liability of any kind for the possible deviation from any provided data or any other damage resulting from the usage of the provided data.

The user agrees to this disclaimer and user agreement with the download or usage of the provided files.

#### LEDiL Oy

Joensuunkatu 13  
FI-24240 SALO  
Finland

#### LEDiL Inc.

228 West Page Street  
Suite D  
Sycamore IL 60178  
USA

#### Local sales and technical support

[www.ledil.com/where\\_to\\_buy](http://www.ledil.com/where_to_buy)

#### Shipping locations

Salo, Finland  
Hong Kong, China

#### Distribution Partners

[www.ledil.com/where\\_to\\_buy](http://www.ledil.com/where_to_buy)



Компания «Life Electronics» занимается поставками электронных компонентов импортного и отечественного производства от производителей и со складов крупных дистрибьюторов Европы, Америки и Азии.

С конца 2013 года компания активно расширяет линейку поставок компонентов по направлению коаксиальный кабель, кварцевые генераторы и конденсаторы (керамические, пленочные, электролитические), за счёт заключения дистрибьюторских договоров

Мы предлагаем:

- Конкурентоспособные цены и скидки постоянным клиентам.
- Специальные условия для постоянных клиентов.
- Подбор аналогов.
- Поставку компонентов в любых объемах, удовлетворяющих вашим потребностям.
- Приемлемые сроки поставки, возможна ускоренная поставка.
- Доставку товара в любую точку России и стран СНГ.
- Комплексную поставку.
- Работу по проектам и поставку образцов.
- Формирование склада под заказчика.
- Сертификаты соответствия на поставляемую продукцию (по желанию клиента).
- Тестирование поставляемой продукции.
- Поставку компонентов, требующих военную и космическую приемку.
- Входной контроль качества.
- Наличие сертификата ISO.

В составе нашей компании организован Конструкторский отдел, призванный помогать разработчикам, и инженерам.

Конструкторский отдел помогает осуществить:

- Регистрацию проекта у производителя компонентов.
- Техническую поддержку проекта.
- Защиту от снятия компонента с производства.
- Оценку стоимости проекта по компонентам.
- Изготовление тестовой платы монтаж и пусконаладочные работы.



Тел: +7 (812) 336 43 04 (многоканальный)

Email: [org@lifeelectronics.ru](mailto:org@lifeelectronics.ru)