

Touch Switch Module Specification

Model : TKU016CT-A100

Specification No.: DS-1980-0001-04

Date of Issue: September 29, 2016 (00)

Revision: October 4, 2016 (01)
 October 31, 2016 (02)
 February 3, 2017 (03)
 February 6, 2017 (04)

Published by
NORITAKE ITRON CORP. / Japan
<http://www.noritake-itron.jp>

This specification is subject to change without prior notice.

This product complies with RoHS Directive
Please contact our sales consultant for details and to confirm the current status

Contents







1	Touch Switch Module Handling and Usage Precautions	4
2	General Description.....	6
2.1	Scope	6
2.2	Construction	6
2.3	Outline	6
2.4	Weight	6
2.5	Block Diagram	7
3	Electrical specifications	8
3.1	Absolute Maximum Ratings.....	8
3.2	Electrical ratings.....	8
3.3	Electrical Characteristics	8
3.4	General-purpose Port.....	9
4	Optical Specifications (Backlight LED)	10
5	Environmental Specifications	10
6	Touch Switch Specification	10
6.1	General Description.....	10
6.2	Basic Operation.....	10
6.3	Cautions	11
6.4	Touch-Switch control	12
6.4.1	Basic function.....	12
6.4.2	Auto-calibration.....	12
6.4.3	Touch-Switch control commands	13
7	Interface.....	14
7.1	Type of interface.....	14
7.2	Basic function	14
7.2.1	Asynchronous serial interface	14
7.2.2	SPI	15
7.2.3	I ² C interface	17
7.3	Key Scan interface	19
7.4	Reset timing	20
8	Function.....	21
8.1	Commands.....	21
8.1.1	All Touch-Switch Status Read [Only valid in Manual transmit mode]	21
8.1.2	Individual Touch-Switch Status Read [Only valid in Manual transmit mode]	21
8.1.3	Touch-Level Order Switch Reading.....	21
8.1.4	All Touch-Switch Count-Level Read.....	22
8.1.5	All Touch-Switch Touch-Level Read	22
8.1.6	Touch-Switch Status read Mode Setting	22
8.1.7	All LED Control	23
8.1.8	Individual LED Control	25
8.1.9	Fixed Buzzer Sound Output Control	25
8.1.10	Buzzer Sound Pitch Control	26
8.1.11	Transmit data control	26
8.1.12	User Setup Mode Start.....	26
8.1.13	User Setup Mode End.....	27
8.1.14	Status Send 1.....	27
8.1.15	Memory SW setting 1.....	27
8.1.16	Memory SW data send 1.....	27
8.1.17	Status Send 2.....	28
8.1.18	Memory Switch Setting 2	28
8.1.19	Memory Switch Data Send 2.....	28
8.1.20	General-purpose Port Input.....	29
8.1.21	General-purpose Port Output.....	29
8.1.22	RAM Program Macro Define / Delete.....	29
8.1.23	Program Macro Execution.....	30
8.1.24	FROM Program Macro Define / Delete	30
8.1.25	Touch Parameter Setting	31
8.1.26	Touch Parameters Send	32
8.1.27	Touch Parameters Save.....	32
8.1.28	Restart Touch Operation	32
8.2	Initial State.....	32
9	Jumper.....	33
9.1	Serial Interface Select	33
9.2	I ² C Slave Address Select.....	33
9.3	Baud Rate Select	33
9.4	Operation Mode Select.....	33
10	Connector.....	34

10.1	Serial Interface (CN2).....	34
10.1.1	Asynchronous Serial Interface mode	34
10.1.2	SPI mode	34
10.1.3	I2C mode	34
10.2	I/O Port Interface.....	34
10.3	Memory Switch (MSW).....	35
11	Physical Dimensions	36
Revision	37



1 Touch Switch Module Handling and Usage Precautions

Please follow the appropriate product application notes and operation standards for proper usage, safe handling, and ideal performance.

【The Glass Touch Switch Panel】

 In the case of the Touch Switch panel's edges are not smooth, it requires careful handling to avoid injury.	 Be careful to avoid breaking the Touch Switch panel as the resulting sharp glass particles may cause injury.
 Do not intentionally destroy the Touch Switch panel.	 Do not use with a sharp object as it will scratch and damage the panel surface.
 To clean the surface of the Touch Switch panel, use a soft cloth and glass cleaner and do not use organic solvents, acids, or alkalis.	 Touch switch panel surface is made only of glass. For washing, an acidic or slightly alkaline detergent for glass can also be used.



【Cable Connection】

 Do not unplug the power and/or data cables from the Touch Switch module during operation, this may result in permanent damage to the module.	 Sending input signals to the Touch Switch module when it is not powered can cause I/O port damage.
 It is recommended to use a 30cm or shorter signal cable to prevent functional failures.	



【Electrostatic Charge】

 Touch Switch modules need electrostatic-free packaging and protection from electrostatic charges during handling and usage.



【Structure】

 It is recommended to use UL-grade materials or components in conjunction with Touch Switch modules.	 Bending and twisting causes stress and may break the Touch Switch panel and module. Please minimize chassis movement to accommodate for the 0.3mm attachment point gap. Failure to do so may result in panel damage.
 Do not apply force to any FPC or cable running from the control board to the Touch Switch panel.	



【Power】

 Apply regulated power to the Touch Switch module within the specified voltages to protect from failures.	 Touch Switch modules may draw in-rush current exceeding twice the typical current at power-on, so a power supply with sufficient capacity and a quick-starting power regulator is recommended.
 The Touch Switch module needs a specific voltage to operate properly. Please use a reliable power cable to avoid a voltage decrease. As a safety measure, a fuse or another type of over-current protection is recommended.	



【Implementation】

 Avoid contact with metal.	 If you would like to create a waterproof application, we recommend that a sturdy and durable sealing material is used between the panel's gasket area and the chassis.
---	--





【Storage and Operating Environment】

 Please use our Touch Switch modules under the specified environmental conditions only. Salty, sulfuric, and dusty environments may damage the module even during storage.	 If used in a high temperature environment, there is a possibility that the Touch Switch panel surface may be hot. There is a risk of burns and other injuries so be careful when touching the panel.
--	---

【Disposal】

 Touch Switch uses materials that contain lead (the RoHS directive exempts these lead compounds for glass that is used with electronic devices).	 When discarding the Touch Switch panel or Touch Switch module, please adhere to the applicable laws and regulations.
---	--

【Other Precautions】

 Although the Touch Switch module is designed to be tolerant of electrical noise, please place an emphasis on noise reduction in your circuit design.	 Do not reconstruct or repair the Touch Switch module without our authorization. We cannot assure the quality or reliability of unauthorized and reconstructed Touch Switch modules.
 We do not authorize the use of any patents that may be inherent in these specifications.	 Whole or partial copying of these specifications is not permitted without our approval. If necessary, please ask for our sales consultant for assistance.
 This product is not designed for military, aerospace, medical or other life-critical applications. If you choose to use this product for these applications, please ask us for prior consultation or we cannot accept responsibility for any problems that may occur.	

2 General Description

2.1 Scope

This specification covers the operation and operating requirements of the Touch Switch Module TKU016CT-A100.

2.2 Construction

The module consists of a mutual-capacitive Touch Switch panel, LEDs for touch switch backlighting, touch controller, and all necessary control logic.

2.3 Outline

- Power supply: Single 5V_{DC} power supply
 - Interface: Serial interfaces
 - Asynchronous serial interface/ I²C / SPI
 - Port
 - General-purpose port / Key scan (selectable)
 - Function:
 - Read Touch Switch ON/OFF
 - Touch operation setting
 - LED setting
 - Buzzer control
 - Program Macro function
 - Miscellaneous
- Applicable Touch Switch Module Reliability Specification : TT-99-3102
 - Applicable Touch Switch Module Quality Specification : TT-98-3413
 - Applicable Touch Switch Panel Quality Specification : TT-16-3301

2.4 Weight

Approximately 78g

2.5 Block Diagram

Number of switches: 16

Number of LED groups: 16

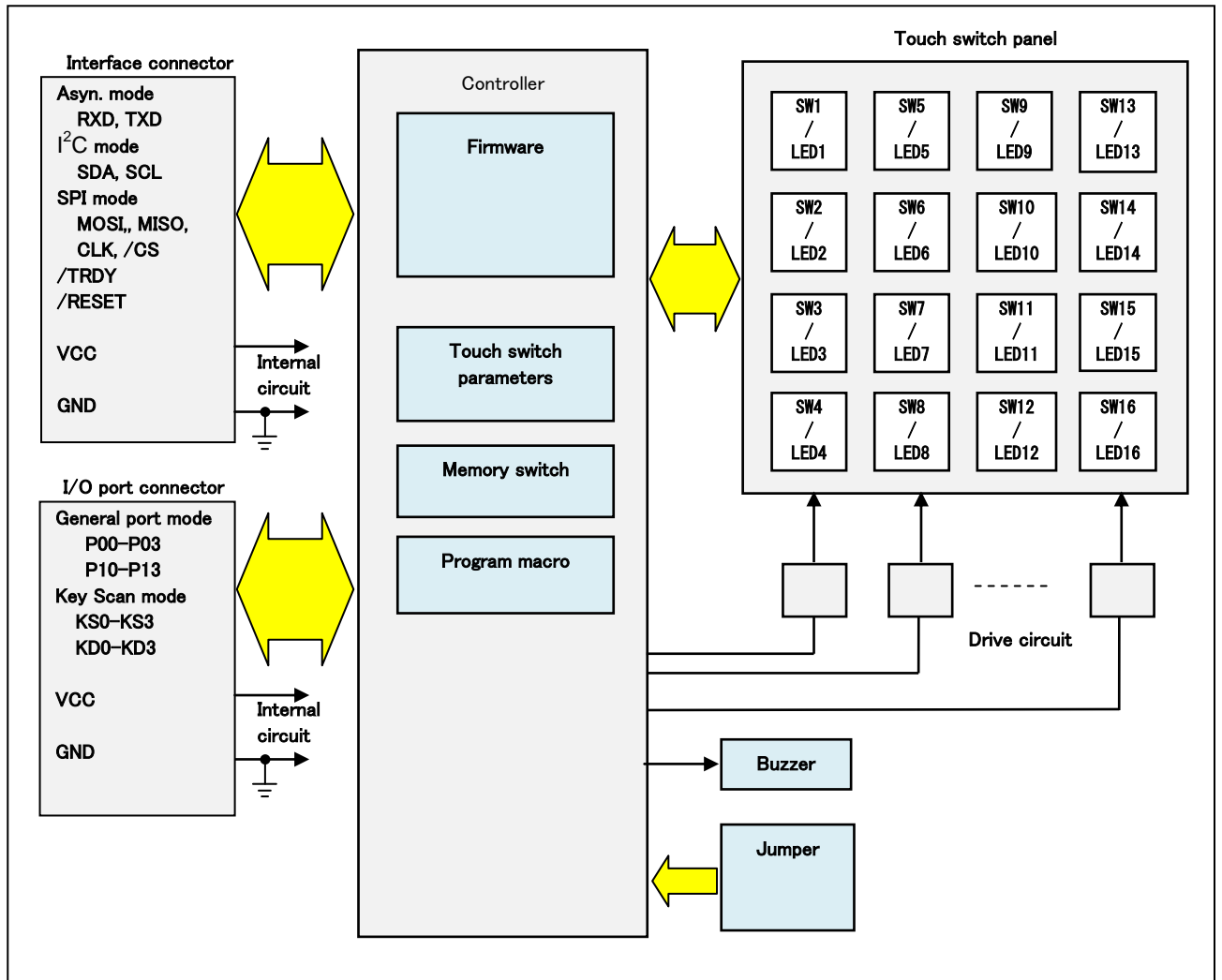

3 Electrical Specifications

3.1 Absolute Maximum Ratings

Parameter	Symbol	Min.	Typ.	Max.	Unit	Condition
Power Supply Voltage	VCC	-0.3	-	6.0	VDC	-
Logic Input Voltage (Pull Up Voltage) KD0-3, P10-P13	VIN-S	-0.3	-	6.0	VDC	-
Logic Input Voltage	VIN	-0.3	-	3.5	VDC	V _{CC} > 3.3
		-0.3	-	VCC	VDC	V _{CC} ≤ 3.3

3.2 Electrical Ratings

Parameter	Symbol	Min.	Typ.	Max.	Unit
Power Supply Voltage	VCC	4.75	5.0	5.25	VDC

3.3 Electrical Characteristics

Measuring Conditions: Ambient temperature = 25 °C, V_{CC} = 5.0 V_{DC}

Parameter		Symbol	Min.	Typ.	Max.	Unit	Condition	
I ² C interface	Logic Input Voltage SDA,SCL	"H"	IIH-1	-	-	1.0	μADC	VIN=3.3V
		"L"	IIL-1	-	-	-0.5	mA	VIN=0V
	Logic Input Voltage /RESET	"H"	IIH-2	-	-	2.0	μADC	VIN=3.3V
		"L"	IIL-2	-	-	-0.5	mA	VIN=0V
	Logic Input Voltage SDA,SCL	"H"	VIH-1	2.7	-	-	VDC	-
		"L"	VIL-1	-	-	0.6	VDC	-
	Logic Input Voltage /RESET	"H"	VIH-2	2.7	-	-	VDC	-
		"L"	VIL-2	-	-	0.2	VDC	-
	Logic Output Voltage SDA,SCL	"L"	VOL-1	-	-	0.8	VDC	IOL= 2mA
	Logic Output Voltage /TRDY	"H"	VOH-2	2.4	-	-	VDC	IOH=-0.5mA
"L"		VOL-2	-	-	0.9	VDC	IOL= 1.0mA	
Other interfaces	Logic Input Current RXD,MOSI,SCK,/CS	"H"	IIH-3	-	-	1.0	μADC	VIN=3.3V
		"L"	IIL-3	-	-	-0.5	mADC	VIN=0V
	Logic Input Current /RESET	"H"	IIH-4	-	-	2.0	μADC	VIN=3.3V
		"L"	IIL-4	-	-	-0.5	mADC	VIN=0V
	Logic Input Voltage RXD,MOSI,SCK,/CS	"H"	VIH-3	2.7	-	-	VDC	-
		"L"	VIL-3	-	-	0.6	VDC	-
	Logic Input Voltage /RESET	"H"	VIH-4	2.7	-	-	VDC	-
		"L"	VIL-4	-	-	0.2	VDC	-
	Logic Output Voltage TXD,MISO,/TRDY	"H"	VOH-3	2.4	-	-	VDC	IOH= -0.5mA
		"L"	VOL-3	-	-	0.9	VDC	IOL= 1.0mA
I/O Port	Logic Input Current KS0-KS3, P00-P03	"H"	IIH-5	-	-	1.0	μADC	VIN=3.3V
		"L"	IIL-5	-	-	-0.5	mADC	VIN=0V
	Logic Input Voltage KS0-KS3, P00-P03	"H"	VIH-5	2.7	-	-	VDC	-
		"L"	VIL-5	-	-	0.6	VDC	-
	Logic Input Voltage KD0-KD3, P10-P13	"H"	VOH-4	Open Collector				
		"L"	VOL-4	-	-	0.5	VDC	IOL = 1mA
	Output allowable current KD0-KD3, P10-P13 (per pin)	"H"	IIOH-1	Open Collector				
		"L"	IIOL-1	-	-	3	mADC	-
Internal Pull-up Resistor RXD,TXD,MOSI,MISO,SCK, /CS,SDA,SCL, /TRDY,/RESET, KS0-KS3, P00-P03		Rp	-	10	-	kΩ	-	

Parameter	Symbol	Min.	Typ.	Max.	Unit	Condition
Power Supply Current 1	ICC-1	-	520	610	mADC	All LED ON (Brightness level 100%) Buzzer ON
Power Supply Current 2	ICC-2	-	260	310	mADC	All LED ON (Brightness level 50%) Buzzer OFF
Power Supply Current 3	ICC-3		30	45	mADC	All LED OFF Buzzer OFF
Power Consumption			2.6	3.1	W	All LED ON (Brightness level 100%) Buzzer ON

- A quick-rise type power supply (<100ms) is recommended.
- At power-on, inrush current can be approximately twice the current in the above table.

3.4 General-purpose Port

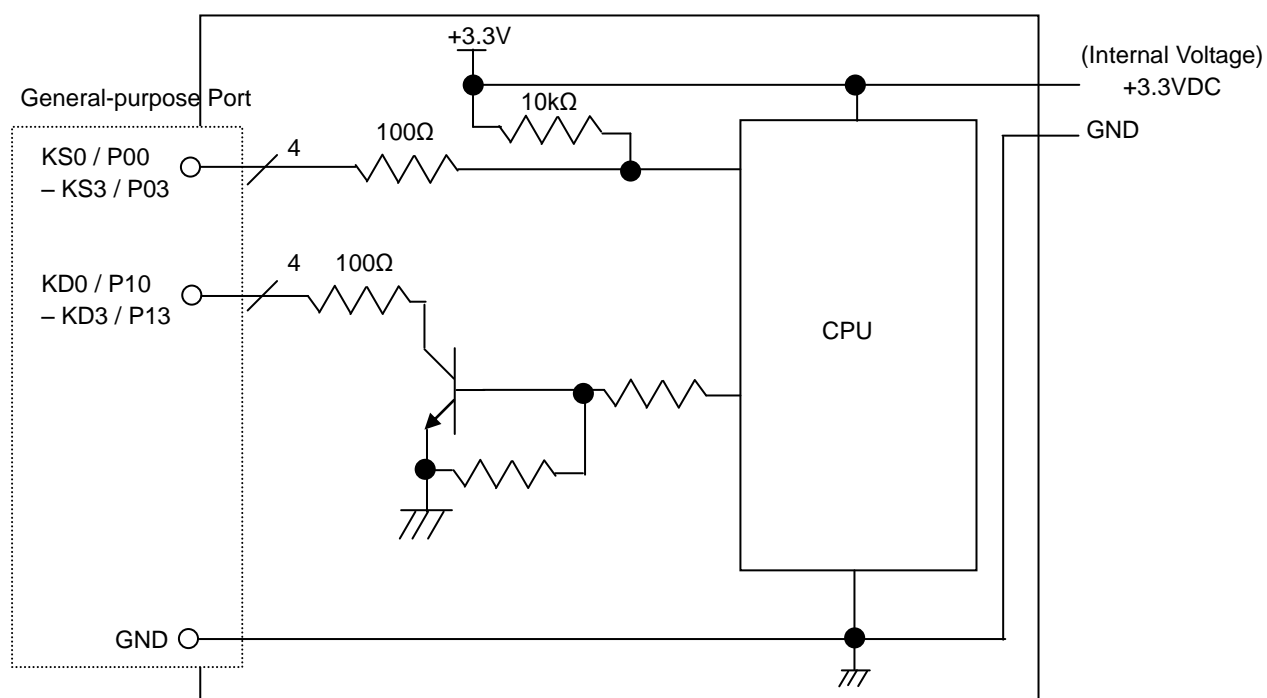

- For electrical characteristics, refer to 3.3 Electrical Characteristics.
- For controlling, refer to 8.1.20 General-purpose Port Input and 8.1.21 General-purpose Port Output commands.

4 Optical Specifications (Backlight LED)

LED color: White

Luminance: LED backlighting is visible when ambient light is less than 500 lux.
(Provided there is no light reflection on the Touch Switch glass.)

5 Environmental Specifications

Operating temperature : -40 to +60 °C (Brightness Level 100%)
: -40 to +85 °C (Brightness Level 50%)

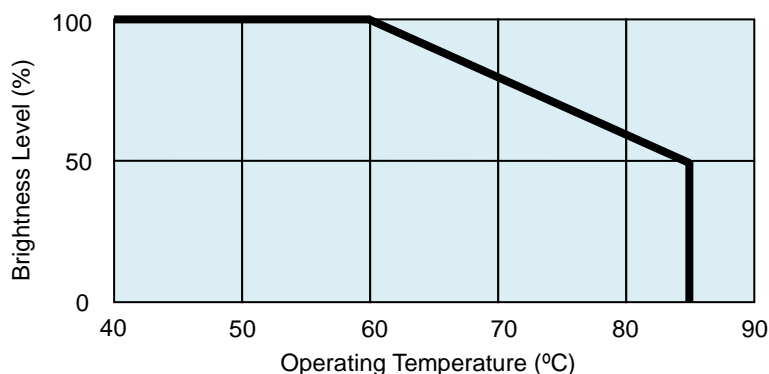

Storage temperature : -40 to +85 °C
Operating humidity : 20 to 80% RH (non-condensing)
Storage humidity : 20 to 80% RH (non-condensing)
Vibration (non-operating) : 10-55-10Hz, all amplitude 1mm, X-Y-Z, 30 minutes
Shock (non-operating) : 392m/s² (40G), 9ms, X-Y-Z, 3 times each direction

6 Touch Switch Specifications

6.1 General Description

Detection method: Mutual Capacitive sensing

Construction: Glass substrate + Aluminum thin film wiring

6.2 Basic Operation

The Touch Switch module features a Touch-Switch panel for handling input by fingertip or touch pen, etc. The switch information data is stored into the module's transmit buffer.

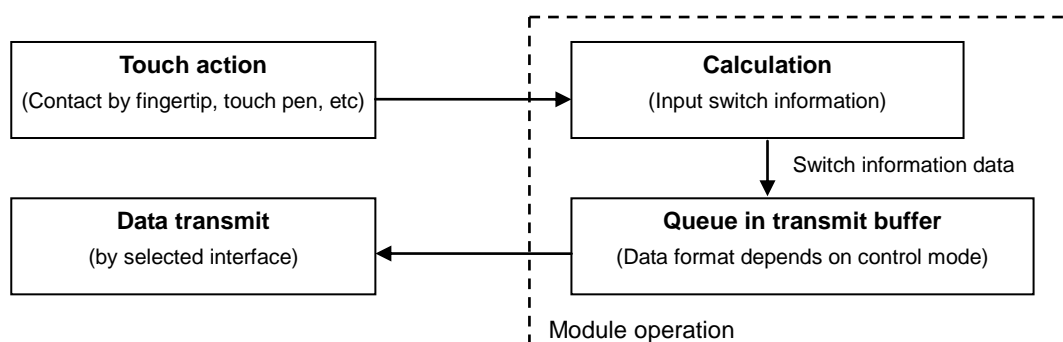

Note: Switch status information can be sent to the host in response to a touch status read command, or it can be sent automatically whenever touch status changes. Current touch status can also be read within a Program Macro, and via the Key Scan interface (if Key Scan mode is enabled).

6.3 Cautions

- When mounting the module in the end product stage, adjust settings while checking the actual operation sensitivity.
- The Touch-Switch cable (FPC) significantly impacts the operation of the Touch-Switch, so the mounting design should ensure that the FPC does not directly contact the device. Do not hold the Touch-Switch panel cable (FPC), and avoid any assembly or operation that would apply stress to the cable.
- The structure of the waterproof adhesive tape, which runs around the edge on the reverse side of the glass, is shown below.

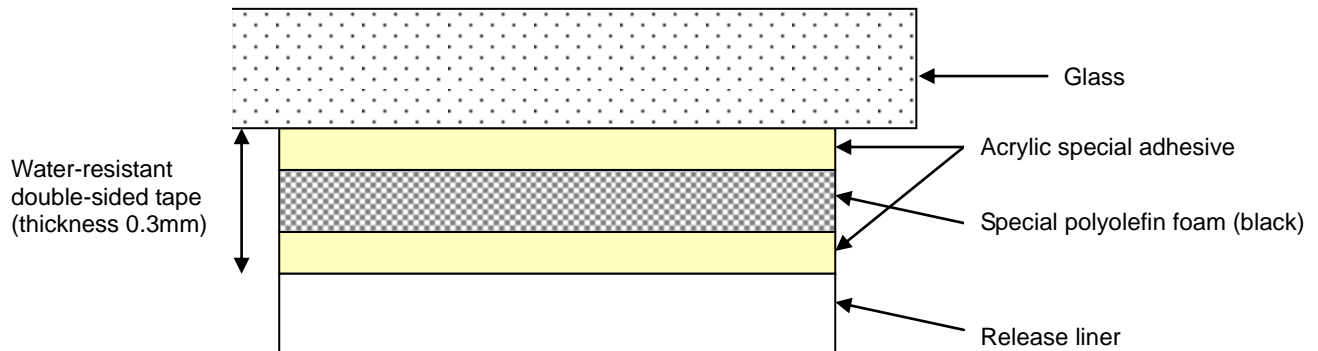

- Moisture, oil and dust on the waterproof adhesive tape can cause peeling. Please keep the surface clean.
- Release liner should be peeled off just before installation into the equipment.
- Touch sensor initialization occurs immediately after the following events. The touch switch surface should not be touched during this initialization time (approximately 3 seconds).

Applicable events: Power-on, /RESET release, User Setup Mode End command, Restart Touch Operation command.

6.4 Touch-Switch Control

6.4.1 Basic Function

- The Touch-Switch module uses the static-capacitive method, wherein ON and OFF are determined by monitoring changes in the measured capacitance. “Count value” represents the measured capacitance, which is used for touch detection as explained below.
- ON / OFF determination**
 - When finger (or equivalent conductor) is not near the Touch-Switch, OFF state is maintained.
 - When finger approaches the Touch-Switch, “Count value” decreases.
 - If “Count value” falls below the “**Judgment level for OFF→ON**”, Touch-Switch turns ON.
 - * If touch parameter **mon** (Continuous touch ON time limit) is set to greater than zero, the ON time is subject to the set limit. If the limit is reached, the Reference value is adjusted equal to the Count value, forcing an OFF judgement.
 - When finger moves away from the Touch-Switch, “Count value” increases.
 - If “Count value” exceeds the “**Judgment level for ON→OFF**”, Touch-Switch turns OFF.

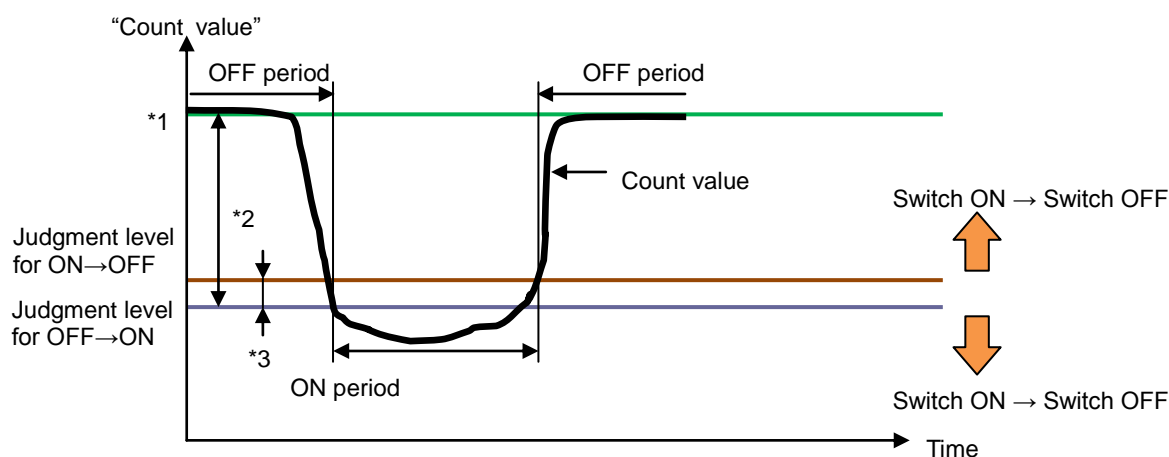

- *1 **Reference value:** Average “Count value” at OFF determination time
- *2 **Threshold value:** The threshold value for OFF → ON (relative to “Reference value”)
- *3 **Hysteresis value:** The margin value for ON → OFF (relative to “Threshold value”)

- Judgement levels are calculated as follows:

Judgment level for OFF→ON = “Reference value” - ((“Threshold value” × “Threshold level”) + “Offset”)

Judgment level for ON→OFF = **Judgment level for OFF→ON** + “Hysteresis value”

6.4.2 Auto-calibration

- When **Auto-calibration function** is ON, if the average of “Count value” changes, due to changes in the surrounding environment, etc., the “Reference value” will continue to change to follow it. The ON and OFF judgement levels will likewise change in synchronization with the “Reference value”. This enables consistent ON/OFF touch detection, unaffected by environmental changes. Auto-calibration can also be disabled by command.

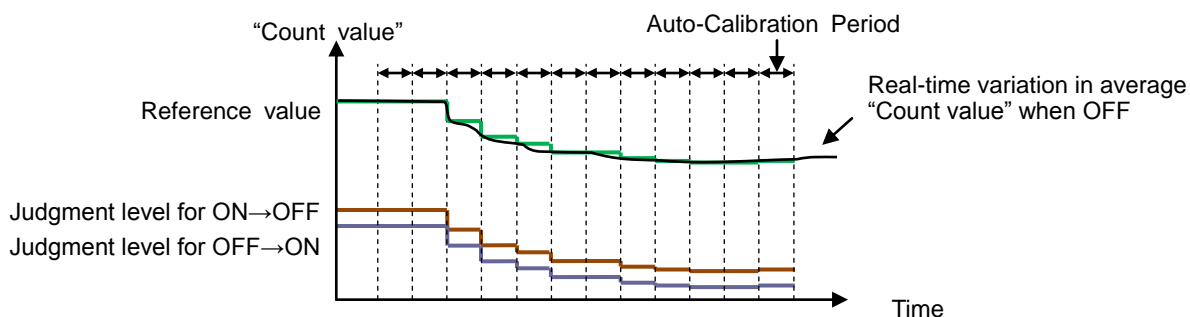

- *: The “Reference value” will re-adjust each Auto-calibration period. The “Threshold value” and the “Hysteresis value” are relative values, so each “Judgment level” for ON/OFF will continue to remain at the same relative level, in synchronization with the “Reference value”.

6. 4. 3 Touch-Switch control commands

Touch-Switch operation is controlled by commands.

- Reading of Touch-Switch ON / OFF state and the Count-Level / Touch-Level

(1) Reading of Touch-Switch ON / OFF state

Two commands can be used to read the ON / OFF state of the Touch-Switches – "**All Touch-Switch Status Read**" and "**Individual Touch-Switch Status Read**".

The module sends the corresponding data (ON: "1", OFF: "0") to the host (refer to the command details for the data format). In addition, the "**Touch-Switch Status Read mode setting**" command is used to set whether touch data is sent only in response to the above commands, or is automatically sent whenever touch status changes are detected by the module. The "**Touch-Level Order Switch Read**" command reports currently-touched switches in touch-level order, enabling appropriate priority handling.

○Detailed explanation pages

Section	Heading
8.1.1	All Touch-Switch Status Read
8.1.2	Individual Touch-Switch Status Read
8.1.6	Touch-Switch Status Read Mode Setting
8.1.3	Touch-Level Order Switch Read

(2) Reading of Count-Level / Touch-Level

The current (real-time) count level and touch level for the Touch-Switches can be read out using the "**All Touch-Switch Count-Level Read**" and "**All Touch-Switch Touch-Level Read**" commands.

"**Count-Level**" is the "Count value" expressed as a **CntLevel**. "**Touch-Level**" is the "Count value" expressed as a normalized value in the range 00h to F8h (upper 5 bits only (32 steps)), with 00h corresponding to Reference value and 80h corresponding to Threshold value. Both values are independent of the Touch-Switch ON / OFF state. Count value changes for each switch can be monitored, allowing the host to determine ON/OFF status.

○Detailed explanation pages

Section	Heading
8.1.4	All Touch-Switch Count-Level Read
8.1.5	All Touch-Switch Touch-Level Read

- Adjustment of internal parameters

A number of internal parameters determine the basic Touch-Switch operation. The parameters can be set, read and saved by commands.

○Detailed explanation pages

Section	Heading
8.1.25	Touch Parameter Setting
8.1.26	Touch Parameter Send
8.1.27	Touch Parameter Save

Parameter	Symbol	All Switches Common Setting	Individual Switch Setting	Effective Range	Default	Condition
Threshold Level	thr	✓	✓	0 to 31	7 (100%)	0 (12.5%: sensitive) to 31 (400%: insensitive)
Offset	offs	✓	✓	0 to 250	0	Offset for Threshold
Hysteresis	hys	✓	✓	1 to 250	20	ON→OFF Change value
Sampling ON Number	son	✓	-	1 to 250	3	ON determination in "son" times continuous ON detection
Sampling OFF Number	soff	✓	-	1 to 250	3	OFF determination in "soff" times continuous OFF detection
Auto Calibration period	clb	✓	-	1 to 250	10	0 : Calibration OFF 1 to 250 : clb × approx. 20ms
Threshold Reference	thrVL	-	✓	1 to 60000	private	Switch individual Setting
	thrVH	-	✓		private	

Parameter Valid: ✓ Parameter Invalid : -

For parameters valid for both All Switches Common Setting and Individual Switch Setting, the order of priority is as follows:

Priority	Referenced content
1 st	Individual Switch Setting Parameter
2 nd	All Switches Command Setting Parameter
3 rd	Default Setting Parameter

7 Interface

7.1 Type of interface

Asynchronous serial, SPI, and I²C (all CMOS-level) are supported, selected by jumpers.

Refer to 9 Jumper.

7.2 Basic function

- Data received is stored in the internal receive buffer, and processed in order of receipt.
- MBUSY signal should be monitored if using SPI at high speed.
- When data is in the transmit buffer, /TRDY = READY.
- User Setup Mode End and Touch Operation Re-start commands cause an internal re-initialization, during which data is unable to be received for approximately 100ms.
- For commands that transmit data (response data), that data should be read before sending the next command.

MBUSY signal change timing:

MBUSY	BUSY ("1")	READY ("0")
Condition	Data in receive buffer / Internal BUSY*	No data in receive buffer

* Internal BUSY: Initialization, FROM definition commands, etc.

/TRDY signal change timing:

/TRDY	EMPTY ("H")	READY ("L")
Condition	No data in transmit buffer	Data in transmit buffer

Buffer Capacity:

Receive buffer	63 bytes
Transmit buffer	63 bytes

7.2.1 Asynchronous serial interface

Interface conditions:

Baud rate	9600 to 115200bps (set by Jumper) Default setting: 38400bps
Parity	None
Format	Start (1 bit) + Data (8 bit) + Stop (1 bit)
Communication control signal	-

Timing

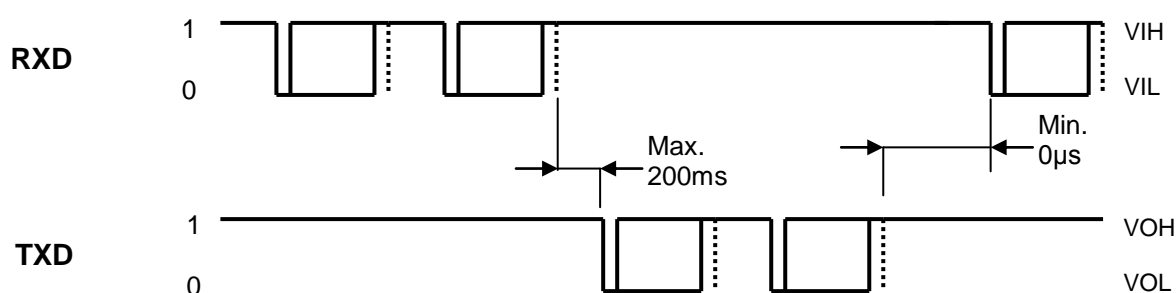

7.2.2 SPI

Interface conditions:

- Touch switch module operates as SPI slave; data is sent and received in response to host (master) operations.
/CS = High → Low → High is one command sequence.

1st byte	Operation mode
44h	Data write (Host → Module)
54h	Data read (Host → Module)
58h	Status read

[Data write]

- When 44h is input as the first byte, the module receives as data the 2nd and subsequent bytes.

	1st byte	2nd byte	3rd byte	---	n byte
MOSI	44h	Data(1)	Data(2)	---	Data(n-1)
MISO	-	-	-	---	-

[Data read]

- When 54h is input as the first byte, the module outputs valid data on the 3rd and subsequent bytes.
- The host must read the number of bytes reported by the immediately preceding Status Read command.
(The number of bytes reported by the Status read command will be transmitted, with any unread bytes discarded.)

	1st byte	2nd byte	3rd byte	---	n byte
MOSI	54h	-	-	---	-
MISO	-	00h	Data(1)	---	Data(n-2)

[Status read]

- When 58h is input as the first byte, the module outputs status data.

For the 3rd and any subsequent bytes, the most recent status data is provided.

	1st byte	2nd byte	3rd byte	---	n byte
MOSI	58h	-	-	---	-
MISO	-	Status	Status	---	Status

Status bit assignment

bit 7	bit 6	bit 5	bit 4	bit 3	bit 2	bit 1	bit 0
MBUSY	0 *	TL(bit 5)	TL(bit 4)	TL(bit 3)	TL(bit 2)	TL(bit 1)	TL(bit 0)

- MBUSY: MBUSY signal status (MBUSY = 0: Low(READY), MBUSY = 1: High(BUSY))
- TL: Number of Transmit data bytes available (maximum 63 bytes)

*: If bit 6 = 1, the Status data is invalid.

○Timing

[Write operation] Data write

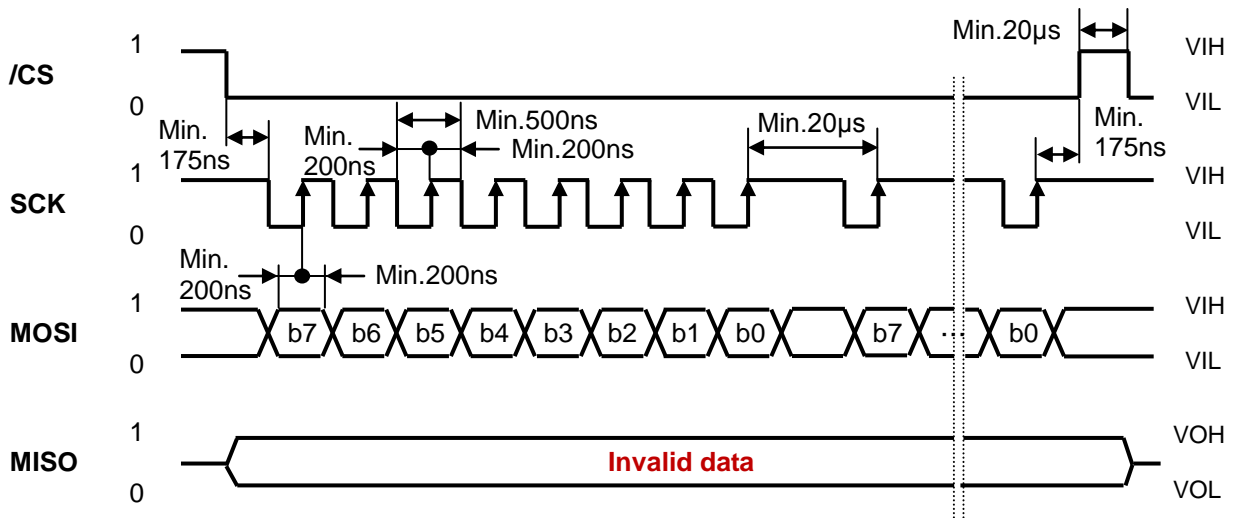

[Read operation] Data read / Status read

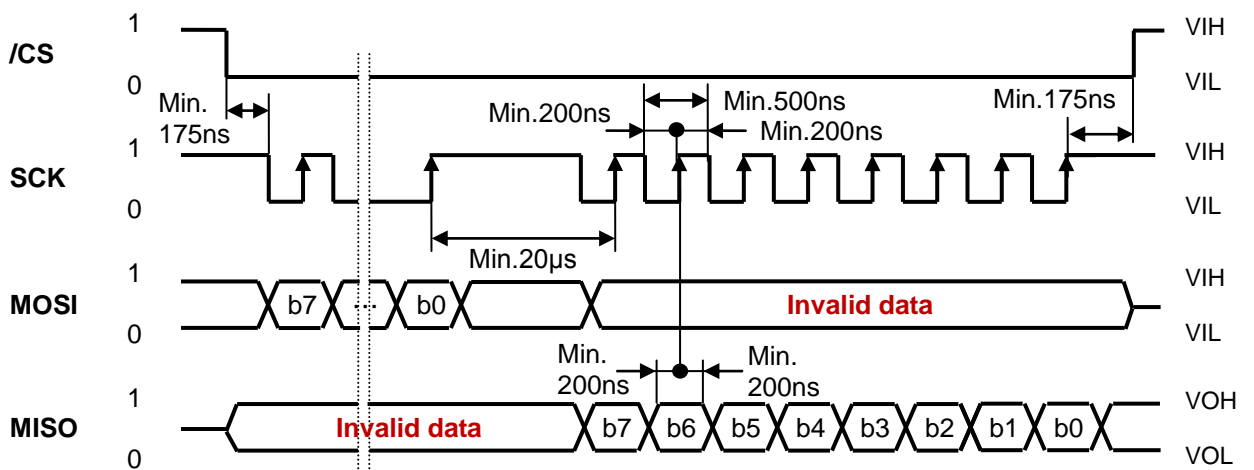

7.2.3 I²C interface

Interface conditions:

- Touch switch module operates as I²C slave, sending and receiving data in response to host (master) operation.

Clock frequency	Max.400kHz
Format	Conforms to the I ² C standard
Slave address	08h to 77h (set by Jumper and Memory SW) Default setting: 50h
Supported functions	ACK response, Clock stretch
Communication control signals	MBUSY, /TRDY

Note: If Clock stretch is applied during processing of a command, the host (master) will not be able to send or receive any more data until command processing has finished.

- In addition to the configured Slave address, the Touch-Switch module also responds to the General call address (00h), however "second byte" functions (06h and 04h) are not supported (the second, and any subsequent bytes, are treated as ordinary data).
- If /TRDY = EMPTY, FFh is transmitted from the VFD module in response to a read sequence.

[Data write sequence]

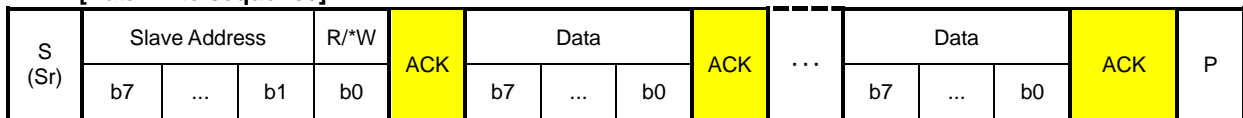

[Data read sequence]

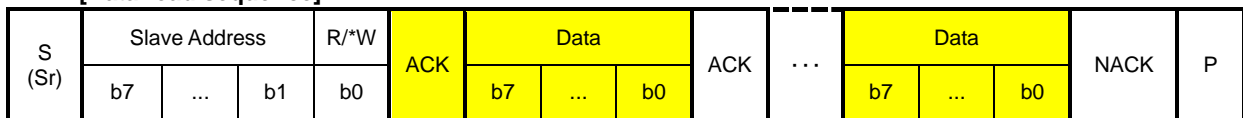

- The host is transmitter, Touch-Switch module is receiver
- The host is receiver, Touch-Switch module is transmitter

Timing

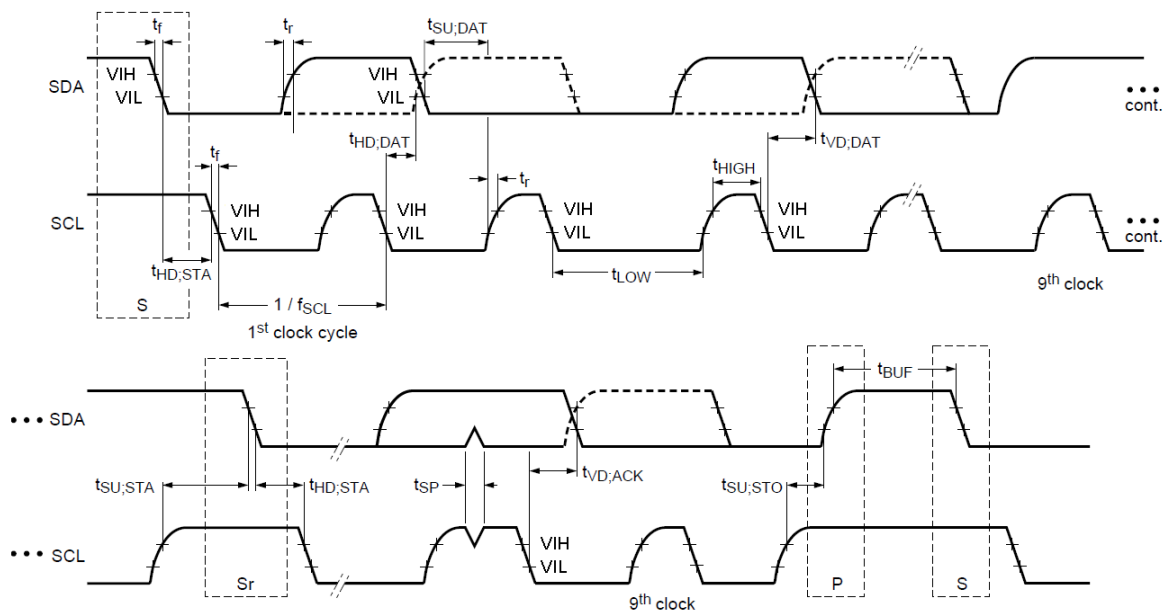

Parameter	Symbol	Condition	Min.	Typ.	Max.	Unit
Pulse width of spikes that must be suppressed by the input filter	t_{SP}	-	0	-	50	ns
SCL clock frequency	f_{SCL}	-	0	-	400	kHz
(Repeat)Start condition hold time	$t_{HD:STA}$	-	0.6	-	-	μ s
SCL LOW time	t_{LOW}	-	1.3	-	-	μ s
SCL HIGH time	t_{HIGH}	-	0.6	-	-	μ s
Repeat Start condition setup time	$t_{SU:STA}$	-	0.6	-	-	μ s
Data hold time	$t_{HD:DAT}$	-	10	-	-	ns
Data setup time	$t_{SU:DAT}$	-	100	-	-	ns
SCL, SDA rise time	t_r	-	20	-	300	ns
SCL, SDA fall time	t_f	$V_{IN}=5.5V$	20	-	300	ns
Stop condition setup time	$t_{SU:STO}$	-	0.6	-	-	μ s
Stop condition - Start condition bus idle time	t_{BUF}	-	20	-	-	μ s
Data valid time	$t_{VD:DAT}$	-	-	-	0.9	μ s
Data valid acknowledge valid time	$t_{VD:ACK}$	-	-	-	0.9	μ s

*: When selecting the external resistor(s), ensure the requirements in the above table are satisfied.
(Refer to 3.3 Electrical Characteristics, for internal pull-up resistor details)

/TRDY timing

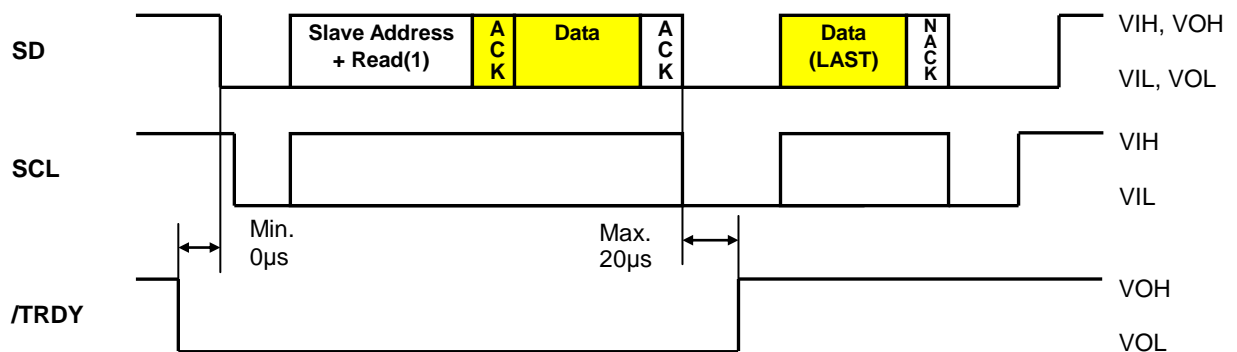

7.3 Key Scan interface

General-purpose port interface can be set to Key Scan mode by Memory SW setting. In this mode, an external host can input a scanning signal pattern into KS0 – KS3 to scan the columns, successively reading-off the touch status for the four switches in the column from KD0 – KD3. The Touch-Switch module effectively emulates a mechanical switch matrix.

When “L” level is input to one of KS0 – KS3, the corresponding switch ON/OFF status is output on KD0 – KD3.

	KS0=L Input	KS1=L Input	KS2=L Input	KS3=L Input
KD0 Output	SW1	SW5	SW9	SW13
KD1 Output	SW2	SW6	SW10	SW14
KD2 Output	SW3	SW7	SW11	SW15
KD3 Output	SW4	SW8	SW12	SW16

KDn Output

SWx = ON : L Output

SWx = OFF : Hi-Z Output

When KS0 – KS3 is set to “H” level, KD0 – KD3 maintain the previous output state.

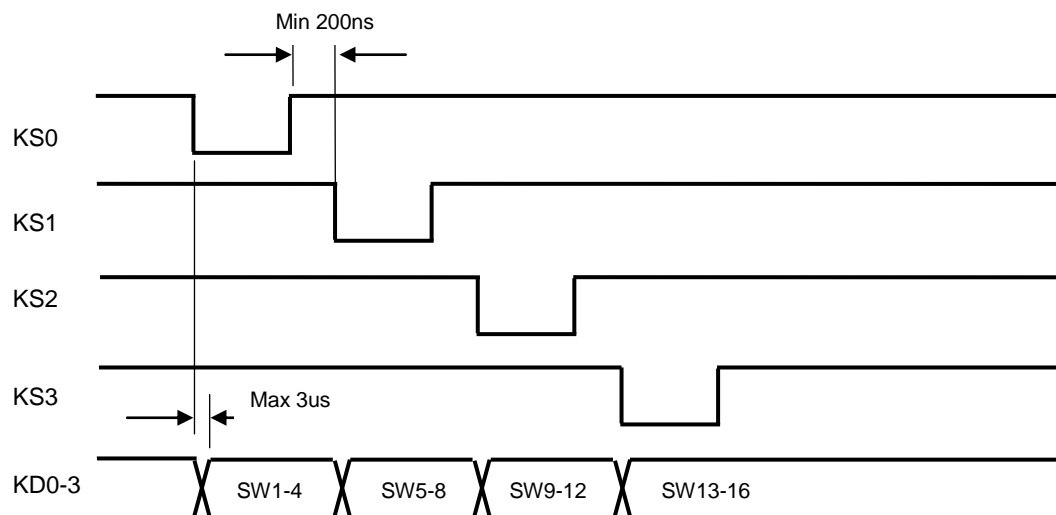

Note:

External pull-up resistors required for KD0 – KD3. Rise time depends on the value of the pull-up resistor.

If KS0 – KS3 is “L” level during power-on or reset, output to KD0 – KD3 does not become active until KS0 – KS3 are first set to “H” level.

7.4 Reset timing

Reset pulse (active low) should be longer than 1ms.

The module sets the MBUSY line upon receipt of /RESET signal and clears the line when ready to receive data.

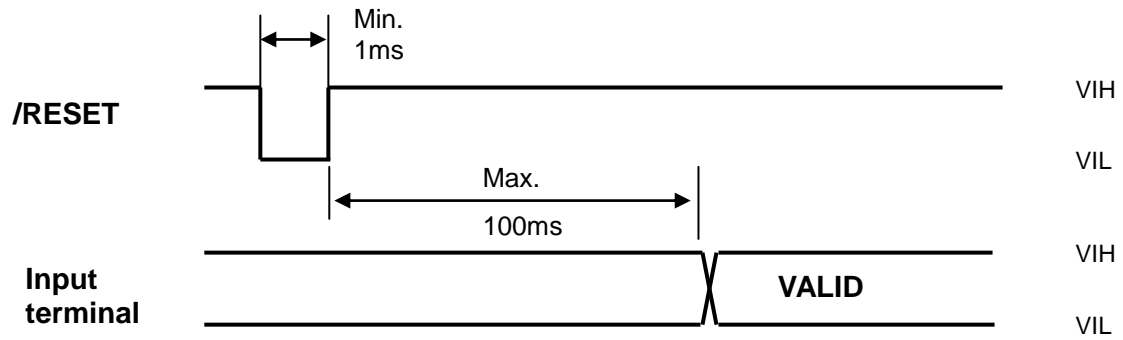

8 Function

8.1 Commands

This section describes the operation of each command.

8.1.1 All Touch-Switch Status Read [Only valid in Manual transmit mode]

[Code]

	1	2	3	4	5	6	7
RX	1Fh	4Bh	10h				
TX				10h	n	d(1)	d(2)

n : Number of data bytes

n = 02h

d : Switch ON/OFF status

	bit7	bit6	bit5	bit4	bit3	bit2	bit1	bit0
d1	SW16	SW15	SW14	SW13	SW12	SW11	SW10	SW9
d2	SW8	SW7	SW6	SW5	SW4	SW3	SW2	SW1

SWn = 0 : Not touched

SWn = 1 : Touched

[Function] Sends ON/OFF status for all Touch-Switches

8.1.2 Individual Touch-Switch Status Read [Only valid in Manual transmit mode]

[Code]

	1	2	3	4	5	6	7
RX	1Fh	4Bh	11h	sn			
TX					11h	sn	d

sn : Switch No.

sn = 00h (SW1) to 0Fh (SW16)

d : Switch ON/OFF status

d = 00h : Not touched

d = 01h : Touched

[Function] Sends ON/OFF status for an individual Touch-Switch

8.1.3 Touch-Level Order Switch Reading

[Code]

	1	2	3	4	5	6	7	8
RX	1Fh	4Bh	12h					
TX				12h	sn(1)	sn(2)	sn(3)	sn(4)

sn(x) : Switch No.

sn(x) = 00h (SW1) to 0Fh (SW16), FFh (untouched)

	sn(1)	sn(2)	sn(3)	sn(4)
Touch-Level	1 st	2 nd	3 rd	4 th

[Function] Sends ON-determined switch numbers in Touch-Level order.

Sends FFh if no (more) switches currently ON.

Example: If 3 switches (1st : SW1, 2nd : SW2, 3rd : SW16) are ON (touched)

Transmit: 12h 00h(SW1) 01h(SW2) 0Fh(SW16) FFh(OFF)

For situations where high sensitivity setting, or water drops, etc cause switches not actually touched to also register ON, this command can be used to obtain only the required switch number(s).

8.1.4 All Touch-Switch Count-Level Read

【Code】

	1	2	3	4	5	6	7	---	21
RX	1Fh	4Bh	14h					---	
TX				14h	In	cl(1)	cl(2)	---	cl(16)

In : 10h (fixed)

cl(x) : Count-level for each switch = 00h to 1Fh

- 【Function】** Sends the count-level for all Touch-Switches.
Count level is a value converted from the internal count value.
Levels are reported regardless of ON/OFF determined status of the switches.

8.1.5 All Touch-Switch Touch-Level Read

【Code】

	1	2	3	4	5	6	7	---	21
RX	1Fh	4Bh	15h					---	
TX				15h	In	tl(1)	tl(2)	---	tl(16)

In : 10h (fixed)

tl(x) : Touch-Level for each switch = 00h to FFh

- 【Function】** Sends the current touch-level (normalized, with respect to the threshold value) for all Touch-Switches.
Touch-level 80h corresponds approximately to the threshold value.
Touch-level returns to 00h when released.

8.1.6 Touch-Switch Status read Mode Setting

【Code】

	1	2	3	4
RX	1Fh	4Bh	18h	m
TX				

m : operating mode

m = 00h: Manual transmit mode (Send only in response to read command)

m = 01h: Automatic transmit mode 1 (All Touch-Switch status)

m = 02h: Automatic transmit mode 2 (Individual Touch-Switch status)

【Default】 m = 00h or Memory SW setting

【Function】 Set read mode of Touch-Switch status

8.1.7 All LED Control

[Code]

	1	2	3	5	6	7	8
RX	1Fh	4Bh	20h	pm1	pm2	d(1)	d(2)
TX							

pm1 : LED brightness control / transition time

	bit7	bi6	bit5	bit4	bit3	bit2	bit1	bit0
pm1	br				tm			

br : LED brightness control

br	LED brightness	br	LED brightness
0	0%	8	45%
1	10%	9	50%
2	15%	10	55%
3	20%	11	60%
4	25%	12	70%
5	30%	13	80%
6	35%	14	90%
7	40%	15	100%

tm : transition time

tm = 0 : Immediate
 tm = 1 to 15 : tm * approx.10ms / step

pm2 : control mode / data length

	bit7	bi6	bit5	bit4	bit3	bit2	bit1	bit0
pm2	md				ln			

md : control mode

md = 0 : All LED mode
 md = 1 : LED selection mode

ln : data length

ln = 2 : 2 bytes (fixed)

d(x) : LED control

	bit7	bi6	bit5	bit4	bit3	bit2	bit1	bit0
d(1)	LED16	LED15	LED14	LED13	LED12	LED11	LED10	LED9
d(2)	LED8	LED7	LED6	LED5	LED4	LED3	LED2	LED1

control mode	LEDn=0	LEDn=1
md = 0 (All LED mode)	OFF (0%)	OFF/ON (br)
md = 1 (LED selection mode)	No change	OFF/ON (br)

[Function] Control multiple LEDs at once.

LEDs change to brightness "br" with a transition time period specified by "tm".

Each LED changes brightness in fixed steps from its current brightness level to the specified level, which means that different LEDs may reach their specified brightness at different times.

The control mode determines which LEDs are affected (ie, all LEDs, or only selected LEDs).

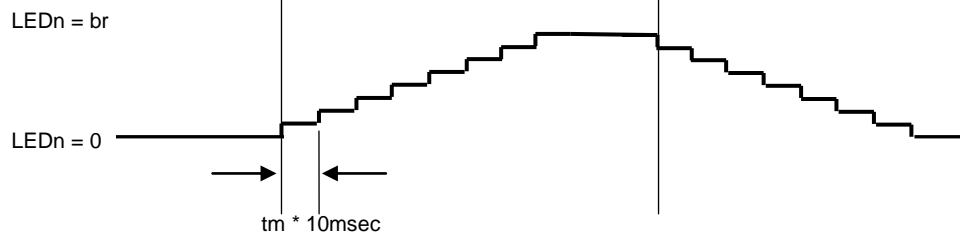
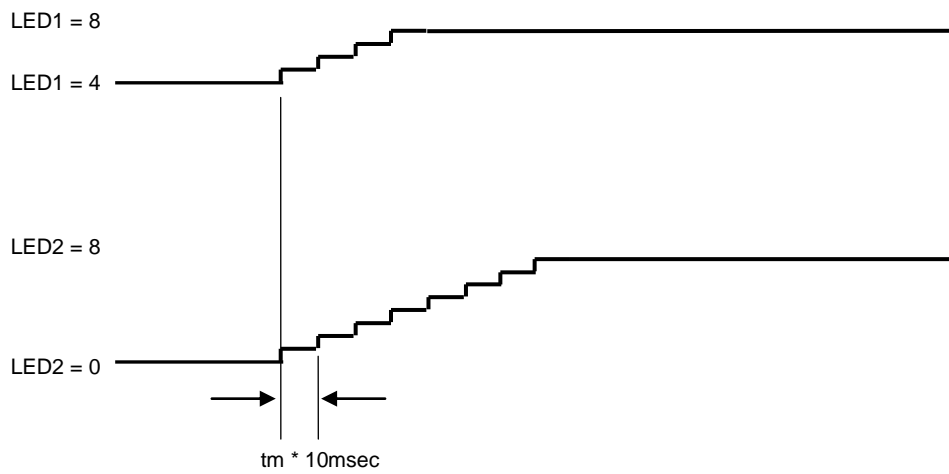
LED brightness change timing (1)**tm = 0:****tm = 1 to 15:****LED brightness change timing (2)****br = 8:**

8.1.8 Individual LED Control

【Code】

	1	2	3	4	5
RX	1Fh	4Bh	21h	In	pm1
TX					

In : LED No.

In = 00h (LED1) to 0Fh (LED16)

pm1 : LED brightness control / change time

	bit7	bit6	bit5	bit4	bit3	bit2	bit1	bit0
pm1	br				tm			

br : LED brightness control

br	LED brightness	br	LED brightness
0	0%	8	45%
1	10%	9	50%
2	15%	10	55%
3	20%	11	60%
4	25%	12	70%
5	30%	13	80%
6	35%	14	90%
7	40%	15	100%

tm : transition time

tm = 0 : Immediate

tm = 1 to 15 : tm * approx.10ms / step

【Function】 Control specified individual LED
 LED brightness changes to brightness “br” with a transition time specified by “tm”.
 LED brightness changes in fixed steps from its current brightness, so total transition time depends on the current brightness level.

8.1.9 Fixed Buzzer Sound Output Control

【Code】

	1	2	3	4
RX	1Fh	4Bh	30h	bt
TX				

bt : buzzer output time

bt = 0 : Stop buzzer output

bt = 1 to 100 : bt * approx. 20ms

【Function】 Output buzzer sound for specified time
 The pitch of the buzzer sound is “C6” (approximately 1047Hz).
 When this command is input during buzzer sound output, outputting buzzer sound is interrupted and the new command is executed.

8. 1. 10 Buzzer Sound Pitch Control

【Code】

	1	2	3	4	5	6	---	(n*2+3)	(n*2+4)
RX	1Fh	4Bh	31h	n	bf(1)	bt(1)	---	bf(n)	bt(n)
TX									

n : number of buzzer notes

n = 1 to 64

bf(x) : buzzer note pitch (frequency accuracy: ±3%)

Buzzer note pitch (scale) values are listed below. If buzzer note pitch is any other value, a rest is inserted for the specified time.

	C	C#	D	D#	E	F	F#	G	G#	A	A#	B
octave 4	40h	41h	42h	43h	44h	46h	47h	48h	49h	4Ah	4Bh	4Ch
octave 5	50h	51h	52h	53h	54h	56h	57h	58h	59h	5Ah	5Bh	5Ch
octave 6	60h	61h	62h	63h	64h	66h	67h	68h	69h	6Ah	6Bh	6Ch
octave 7	70h	-	-	-	-	-	-	-	-	-	-	-

bt(x) : buzzer sound output time

bt(x) = 0 : buzzer output invalid

bt(x) = 1 to 100 : bt(x) * approximately 20ms

【Function】 Output buzzer sounds with selected note/octave and duration

If this command is executed during buzzer sound output, the buzzer sound is interrupted and the new buzzer sound starts immediately.

8. 1. 11 Transmit data control

【Code】

	1	2	3	4
RX	1Fh	4Bh	F0h	md
TX				

md : Transmit data enable/disable

md = 0 : Disable

md = 1 : Enable

Default: md = 1 (Enable)

【Function】 Enables or disables writing of transmit data to the internal transmit buffer.

When disabled, transmit data destined for the host (response data, etc) is discarded and not actually placed in the internal transmit buffer for transmission.

This command is for use with a Program Macro that will read and process response data from the Work Memory, and response data does not need to be sent to the host.

8. 1. 12 User Setup Mode Start

【Code】

	1	2	3	4	5	6	7	8	9	10
RX	1Fh	28h	65h	01h	49h	4Eh				
TX							28h	65h	01h	00h

【Function】 Start User setup mode and send the response data

This command is only valid in Normal mode.

8. 1. 13 User Setup Mode End

【Code】

	1	2	3	4	5	6	7
RX	1Fh	28h	65h	02h	4Fh	55h	54h
TX							

【Function】 End User setup mode and restart

8. 1. 14 Status Send 1

【Code】

	1	2	3	4	5	6	---	(x + 5)
RX	1Fh	4Bh	40h	n				
TX					40h	d(1)	---	d(x)

n: Information type

n = 02h: Firmware version information

n = 30h: Product type information

n = 40h: Switch number information

n = 41h: Buzzer fitted / not fitted information

【Function】 Send the product status information
Sent data length depends on the Information type.

n: Information type	Data length	Contents
02h	d(1) to d(5) : 5 bytes	20h to 7Fh : 【example】 "1.00 "
30h	d(1) to d(7) : 7 bytes	20h to 7Fh : 【example】 "TKU-STD"
40h	d(1) : 1 byte	01h to FFh : 【example】 10h
41h	d(1) : 1 byte	00h = Buzzer not fitted, 01h = Buzzer fitted 【example】 01h

8. 1. 15 Memory SW setting 1

【Code】

	1	2	3	4	5	---	19	20
RX	1Fh	4Bh	51h	m _{sw} (0)	m _{sw} (1)	---	m _{sw} (15)	
TX								51h

m_{sw}(0) to m_{sw}(15): Memory switch setting value

m_{sw}(x) = FFh: No change

【Function】 Set Memory SW value
Set values are stored into flash memory, and used on next startup.
This command is only valid in User Setup Mode.

8. 1. 16 Memory SW data send 1

【Code】

	1	2	3	4	5	6	---	20
RX	1Fh	4Bh	52h					
TX				52h	m _{sw} (0)	m _{sw} (1)	---	m _{sw} (15)

m_{sw}(0) to m_{sw}(15): Memory switch contents (refer to 10.3 Memory Switch (MSW) for details)

【Function】 Send Memory SW values

8. 1. 17 Status Send 2

【Code】

	1	2	3	4	5	6	7	8	9	---	(x + 8)
RX	1Fh	28h	65h	40h	n						
TX						28h	65h	40h	d(1)	---	d(x)

n: Information type

n = 02h: Firmware version information

n = 30h: Product type information

n = 40h: Switch number information

n = 41h: Buzzer fitted / not fitted information

【Function】 Send the product status information

Sent data length depends on the Information type.

n: Information type	Data length	Contents
02h	d(1) to d(4) : 4 bytes	20h to 7Fh: 【example】 "1.00 "
30h	d(1) to d(15) : 15 bytes	20h to 7Fh: 【example】 "TKU-STD _____ "
40h	d(1) to d(3) : 3 bytes	20h to 7Fh: 【example】 16 switches = "016"
41h	d(1) to d(3) : 3 bytes	20h to 7Fh: 【example】 Buzzer not fitted = "000" Buzzer fitted = "001"

8. 1. 18 Memory Switch Setting 2

【Code】

	1	2	3	4	5	6
RX	1Fh	28h	65h	03h	n	d
TX						

n: Memory switch number (refer to 10.3 Memory Switch (MSW) for details)

n = 0 (MSW1) to 63 (MSW63)

d: Set value (refer to 10.3 Memory Switch (MSW) for details)

d = FFh: No change

【Function】 Set Memory SW value

Set values are stored into flash memory, and used on next startup.

This command is only valid in User Setup Mode.

8. 1. 19 Memory Switch Data Send 2

【Code】

	1	2	3	4	5	6	7	8	9
RX	1Fh	28h	65h	04h	n				
TX						28h	65h	04h	d

n: Memory switch number (refer to 10.3 Memory Switch (MSW) for details)

n = 0 (MSW1) to 63 (MSW63)

d: Memory switch content

【Function】 Send memory switch value

8. 1. 20 General-purpose Port Input

【Code】

	1	2	3	4	5	6	7	8	9
RX	1Fh	28h	70h	20h	n				
TX						28h	70h	20h	d

n: Port number

n = 00h: Port0 (P00 to P03)

d: Port output value

	bit7	bit6	bit5	bit4	bit3	bit2	bit1	bit0
d	0	0	0	0	P03	P02	P01	P00

d bit value "0" = Input Low level

d bit value "1" = Input High level

【Function】 Send data at input ports

8. 1. 21 General-purpose Port Output

【Code】

	1	2	3	4	5	6
RX	1Fh	28h	70h	10h	n	d
TX						

n: Port number

n = 01h: Port1 (P10 to P13)

d: Port output value

	bit7	bit6	bit5	bit4	bit3	bit2	bit1	bit0
d	0	0	0	0	P13	P12	P11	P10

d bit value "0" = OPEN (Hi-Z)

d bit value "1" = Output Low level

【Function】 Control general-purpose port output
 Since Port1 is an open collector output, attach a pull-up resistor on the host side as necessary.
 Note that logic level is inverted.

8. 1. 22 RAM Program Macro Define / Delete

【Code】

	1	2	3	4	5	---	(p + 4)
RX	1Fh	3Ah	pL	pH	d(1)	---	d(p)
TX							

pL: RAM Program Macro data length, lower byte

pH: RAM Program Macro data length, upper byte

(pL + pH * 256) = 0 to 256

d: RAM Program Macro data

【Function】 Define or delete RAM Program Macro
 (pL + pH * 100h) > 0000h: Supplied data "d" is stored as Program Macro.
 (pL + pH * 100h) = 0000h: Program Macro is deleted.
 If Program Macro data length "p" is outside the definable area, the command is cancelled, and the following data is treated as standard data.
Program Macro details: Refer to "Program Macro" Software specification.

8. 1. 23 Program Macro Execution

[Code]

	1	2	3	4	5
RX	1Fh	5Eh	a	t1	t2
TX					

a: Program Macro definition number

a = 80h: RAM Program Macro

a = 81h: FROM Program Macro

t1: Reserved

t1 = 0 to 255

t2: Reserved

t1 = 0 to 255

[Function]

Execute contents of Program Macro definition number "a".

If Program Macro "a" is not defined, or if "a" is outside the definable area, the entire command (up to t2) is ignored.

Program Macro execution operation follows the Program Macro script specification.

Program Macro execution is stopped by END command specified within Program Macro definition.

8. 1. 24 FROM Program Macro Define / Delete

[Code]

	1	2	3	4	5	6	7	8	9	10	---	(p + 9)
RX	1Fh	28h	65h	12h	a	pL	pH	t1	t2	d(1)	---	d(p)
TX												

a: Program Macro definition number

a = 01h: FROM Program Macro

pL: FROM Program Macro data length, lower byte

pH: FROM Program Macro data length, upper byte

$pL + pH * 256 = 0$ to 4096

t1: Reserved

t1 = 0 to 255

t2: Reserved

t1 = 0 to 255

[Function]

Define or delete FROM Program Macro

$(pL + pH \times 100h) > 0000h$: Supplied data "d" is stored as Program Macro.

$(pL + pH \times 100h) = 0000h$: Program Macro is deleted.

If program macro data length "p" is outside the definable area, the command is cancelled, and the following data is treated as standard data.

This command is only valid in User Setup Mode.

Do not define any of the following commands in a Macro;

Program Macro Execution, RAM Program Macro Define / Delete, User Setup Mode Start.

Program Macro details: Refer to "Program Macro" Software specification.

8. 1. 25 Touch Parameter Setting

【Code】

	1	2	3	4	5	6	7	8	9	10	11	12	13
RX	1Fh	4Bh	54h	sn	d(1)	d(2)	d(3)	d(4)	d(5)	d(6)	d(7)	d(8)	
TX													54h

sn: Switch number

sn = 00h (SW1) to 0Fh (SW16) : Individual switch setting

sn = FEh : All switch setting 2

sn = FFh : All switch setting

If sn = 00h to 0Fh or FFh:

d(1) / thr: Threshold level

thr = 0 to 31 : Threshold level (thr + 1) × 12.5%

thr = 0 : 12.5%

thr = 7 : 100%

thr = 31 : 400%

d(2) / offs: Threshold offset

d(3) / hys: Hysteresis

d(4) / son: Sampling time setting (ON decision)

d(5) / soff: Sampling time setting (OFF decision)

d(6) / clb: Auto-calibration period setting

clb = 0 to 250

clb = 0 : Auto calibration OFF

clb = 1 to 250 : clb × approximately 20ms

d(7) / thrVL: Threshold reference, lower byte

d(8) / thrVH: Threshold reference, upper byte

Parameter	All switch setting FFh	Individual switch setting 00h to 0Fh	Effective range	No change	Default
thr	✓	✓	0 to 31	255 (FFh)	7
offs	✓	✓	0 to 250	255 (FFh)	0
hys	✓	✓	1 to 250	255 (FFh)	20
son	✓	-	1 to 250	255 (FFh)	3
soff	✓	-	1 to 250	255 (FFh)	3
clb	✓	-	1 to 250	255 (FFh)	10
thrVL	-	✓	1 to 60000	65535 (FFFFh)	Private
thrVH	-				

Parameter Valid: ✓ Parameter Invalid : -

If sn = FEh:

d(1) / mon: Continuous touch ON time limit

mon = 0 to 250

mon = 0 : No continuous touch time limit

mon = 1 to 250 : Continuous touch ON time limited to: mon × approximately 20ms

d(2) to d(8) / rsv: Reserved

Set these parameters to FFh (no change)

d(8) / thrVH: Threshold reference, upper byte

Parameter	Effective range	No change	Default
mon	0 to 250	255 (FFh)	0
rsv	-	255 (FFh)	Private

【Function】

Set various parameters for Touch-Switch

Parameter settings may be applicable for all switches, or individual switches, as shown above.

Parameter settings are effective immediately.

Use the Touch Parameters Save command to store the parameters to non-volatile memory if necessary.

8.1.26 Touch Parameters Send

【Code】

	1	2	3	4	5	6	7	8	9	10	11	12	13
RX	1Fh	4Bh	55h	sn									
TX					55h	d(1)	d(2)	d(3)	d(4)	d(5)	d(6)	d(7)	d(8)

sn: Switch number

sn = 00h (SW1) to 0Fh (SW16) : Individual switch setting

sn = FEh : All switch setting 2

sn = FFh : All switch setting

d(1) to d(8): Various parameters (refer to 8.1.25 Touch Parameter Setting).

【Function】 Send various touch switch parameters

8.1.27 Touch Parameters Save

【Code】

	1	2	3	4	5
RX	1Fh	4Bh	56h	md	
TX					56h

md: Mode

md = 5Ah : Save current parameters to memory

md = A5h : Save default parameters to memory

【Function】 Save Touch-Switch parameters to memory
This command is only valid in User Setup Mode.

8.1.28 Restart Touch Operation

【Code】

	1	2	3	4	5
RX	1Fh	4Bh	57h	5Ah	
TX					57h

【Function】 Restart Touch-Switch operation with parameters re-loaded from memory.

8.2 Initial State

The module's initial state is as follows:

Item	Initial state
LED	All LEDs off
Buzzer	Buzzer sound output off
Touch Switch	Switch OFF state
Other	Initial values, subject to Jumper and MSW settings

9 Jumper

No.	Function	Condition
J0	Baud rate select / I ² C slave address select	OPEN
J1		OPEN
J2	Serial interface select	OPEN
J3		OPEN
J4	Reserved	OPEN
JT	Operation mode select	OPEN

9.1 Serial Interface Select

J2	J3	Condition
–	OPEN	Asynchronous serial interface
OPEN	SHORT	I ² C interface
SHORT	SHORT	SPI

9.2 I²C Slave Address Select

I²C address setting is set by a combination of Memory SW and Jumper.

J0	J1	Slave address
OPEN	OPEN	50h *1
SHORT	OPEN	51h *1
OPEN	SHORT	70h *1
SHORT	SHORT	MSW14 setting *2

*1: The module also responds on the General call address (00h).

*2: Response to General call address can be disabled (see below).

MSW14	Condition
08h to 77h	Slave address is set 08h to 77h. The module also responds to the General call address
88h to F7h	Slave address is set 08h to 77h (lower 7 bits). No response to general call address
Out of range	Slave address is set to 71h. The module also responds to the General call address

9.3 Baud Rate Select

J0	J1	Condition
OPEN	OPEN	38400bps
SHORT	OPEN	19200bps
OPEN	SHORT	9600bps
SHORT	SHORT	115200bps

9.4 Operation Mode Select

JT	Operation mode
OPEN	Normal mode
SHORT	Test mode (Factory use only)

10 Connector

10.1 Serial Interface (CN2)

* IC: Leave unconnected

10.1.1 Asynchronous Serial Interface mode

Pin No.	Signal	Function	Direction
1	VCC	Power supply	Input
2	RXD	Data receive	Input
3	GND	Ground	Input
4	IC	Internal connection	-
5	IC	Internal connection	-
6	/RESET	Reset	Input
7	IC	Internal connection	-
8	TXD	Data send	Output
9	IC	Internal connection	-

10.1.2 SPI mode

Pin No.	Signal	Function	Direction
1	VCC	Power supply	Input
2	MOSI	Data receive	Input
3	GND	Ground	Input
4	IC	Internal connection	-
5	SCK	Serial clock	Input
6	/RESET	Reset	Input
7	/CS	Chip select	Input
8	MISO	Data send	Output
9	IC	Internal connection	-

10.1.3 I2C mode

Pin No.	Signal	Function	Direction
1	VCC	Power supply	Input
2	SDA	Serial data	Input/Output
3	GND	Ground	Input
4	IC	Internal connection	-
5	SCL	Serial clock	Input/Output
6	/RESET	Reset	Input
7	IC	Internal connection	-
8	IC	Internal connection	-
9	/TRDY	Transmit ready	Output

10.2 I/O Port Interface (CN1)

Pin No.	Signal	Function	Direction
1	KS0 / P00	Key scan select / General-purpose input port	Input
2	KS1 / P01	Key scan select / General-purpose input port	Input
3	KS2 / P02	Key scan select / General-purpose input port	Input
4	KS3 / P03	Key scan select / General-purpose input port	Input
5	KD0 / P10	Key scan data / General-purpose output port	Output
6	KD1 / P11	Key scan data / General-purpose output port	Output
7	KD2 / P12	Key scan data / General-purpose output port	Output
8	KD3 / P13	Key scan data / General-purpose output port	Output
9	VCC	Power supply	Input
10	GND	Ground	Input

10.3 Memory Switch (MSW)

MSW No.	Function	Valid range	Default value
MSW0 to 3	Reserved	-	-
MSW4	Touch-Switch read setting	00h : Manual transmit mode 01h : Auto transmit mode All touch-switch status read 02h : Auto transmit mode Individual touch-switch status read	00h
MSW5 to 12	Reserved	-	-
MSW13	Port setting	00h: Key Scan mode 01h: General-purpose port mode	00h
MSW14	I ² C Slave address	08h to 77h: Slave address (08h to 77h) (Module also responds on the General call address) 88h to F7h: Slave address (08h to 77h) (Module does not respond on General call address)	71h
MSW15 to 18	Reserved	-	-
MSW19	Power-on Program Macro automatic execution	00h : No start 81h : Program Macro start	00h
MSW20 to 63	Reserved	-	-

* Setting and reading MSW16 to MSW63 is only possible using the Memory Switch Setting 2 and Memory Switch Data Send 2 commands respectively.

* Module operates with default value if Memory SW value is outside the valid range.

11 Physical Dimensions

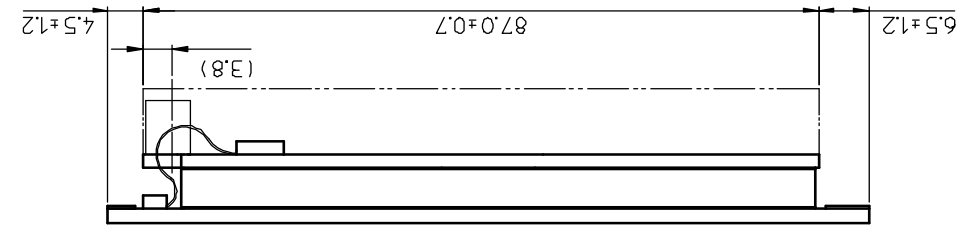

() : Reference only
Unit : mm

DS-1980-0100-01

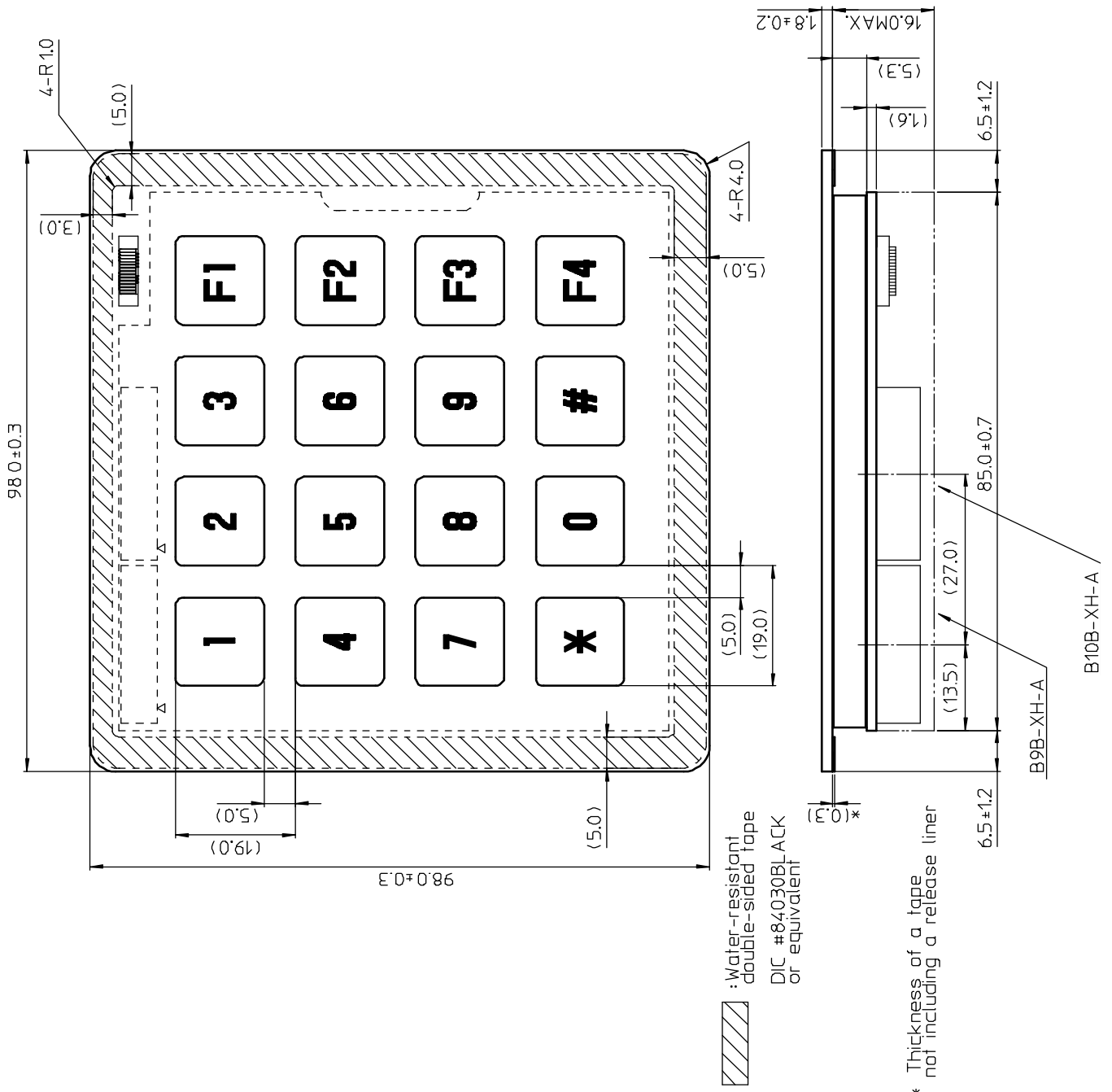

Revision

Specification No.	Date	Revision
DS-1980-0001-00	Sep. 29, 2016	Initial issue
DS-1980-0001-01	Oct. 4, 2016	<p>2.3 Outline</p> <p>Applicable Touch Switch Module reliability specification TT-12-3301A → TT-12-3102</p> <p>Applicable Touch Switch Module quality specification TT-12-3401A → TT-12-3401</p> <p>6.3 Cautions</p> <p>Separator → Release liner</p> <p>7.3 Key Scan interface</p> <p>Key scan timing corrected</p> <p>8.1.3 Touch-Level Order Switch Reading</p> <p>Example sentence corrected</p> <p>8.1.7 All LED Display Control → All LED Control</p> <p>8.1.8 Individual LED Display Control → Individual LED Control</p> <p>11 Physical Dimensions</p> <p>DS-1980-0100-00 → DS-1980-0100-01</p> <p>Comment changed</p> <p>Other minor changes</p>
DS-1980-0001-02	Oct. 31, 2016	<p>2.3 Outline</p> <p>Applicable Touch Switch Module reliability specification TT-12-3102 → TT-99-3102</p> <p>Applicable Touch Switch Module quality specification TT-12-3401 → TT-98-3413</p> <p>Applicable Touch Switch specification T.B.D. → TT-16-3301</p> <p>3.3 Electrical Characteristics</p> <p>Corrected signals</p>
DS-1980-0001-03	Feb. 3, 2017	<p>1 Touch Switch Module Handling and Usage Precautions</p> <p>The item position change and sentences correction</p> <p>7.2.1 Asynchronous serial interface</p> <p>Communication control signal changed</p> <p>/TRDY removed</p> <p>8.1.10 Buzzer Sound Pitch Control</p> <p>Octave number and terminology correction</p> <p>10.1.1 Asynchronous Serial Interface mode</p> <p>Signal name of Pin No9 changed</p> <p>/TRDY → IC</p> <p>10.1.2 SPI mode</p> <p>Signal name of Pin No9 changed</p> <p>/TRDY → IC</p> <p>10.2 I/ Port Interface (CN1)</p> <p>Additional connector number</p> <p>Correction other minor errors</p>
DS-1980-0001-04	Feb. 6, 2017	<p>10.1.2 SPI mode</p> <p>Pin No.7 function correction</p>

Mouser Electronics

Authorized Distributor

Click to View Pricing, Inventory, Delivery & Lifecycle Information:

[Noritake:](#)

[TKU016CT-A100](#)

Компания «Life Electronics» занимается поставками электронных компонентов импортного и отечественного производства от производителей и со складов крупных дистрибьюторов Европы, Америки и Азии.

С конца 2013 года компания активно расширяет линейку поставок компонентов по направлению коаксиальный кабель, кварцевые генераторы и конденсаторы (керамические, пленочные, электролитические), за счёт заключения дистрибьюторских договоров

Мы предлагаем:

- Конкурентоспособные цены и скидки постоянным клиентам.
- Специальные условия для постоянных клиентов.
- Подбор аналогов.
- Поставку компонентов в любых объемах, удовлетворяющих вашим потребностям.
- Приемлемые сроки поставки, возможна ускоренная поставка.
- Доставку товара в любую точку России и стран СНГ.
- Комплексную поставку.
- Работу по проектам и поставку образцов.
- Формирование склада под заказчика.
- Сертификаты соответствия на поставляемую продукцию (по желанию клиента).
- Тестирование поставляемой продукции.
- Поставку компонентов, требующих военную и космическую приемку.
- Входной контроль качества.
- Наличие сертификата ISO.

В составе нашей компании организован Конструкторский отдел, призванный помогать разработчикам, и инженерам.

Конструкторский отдел помогает осуществить:

- Регистрацию проекта у производителя компонентов.
- Техническую поддержку проекта.
- Защиту от снятия компонента с производства.
- Оценку стоимости проекта по компонентам.
- Изготовление тестовой платы монтаж и пусконаладочные работы.



Тел: +7 (812) 336 43 04 (многоканальный)

Email: org@lifeelectronics.ru