

PLASTIC CONNECTORS



SERIES



Precision modular connectors to suit your application

Since its creation in Switzerland in 1946 the LEMO Group has been recognized as a global leader of circular Push-Pull connectors and connector solutions. Today LEMO and its affiliated companies, REDEL and COELVER, are active in more than 80 countries with the help of over 40 subsidiaries and distributors.

Over 5'000 REDEL connectors



The modular design of the REDEL range provides over 5'000 connectors from \varnothing 14 mm to \varnothing 21 mm, capable of handling cable diameters up to 9.5 mm and up to 32 contacts.

This vast portfolio enables you to select the ideal connector configuration to suit almost any specific requirement in most markets, including medical devices, test and measurement instruments, machinery, audio video broadcast, telecommunications and military.

REDEL's Push-Pull Self-Latching Connection System

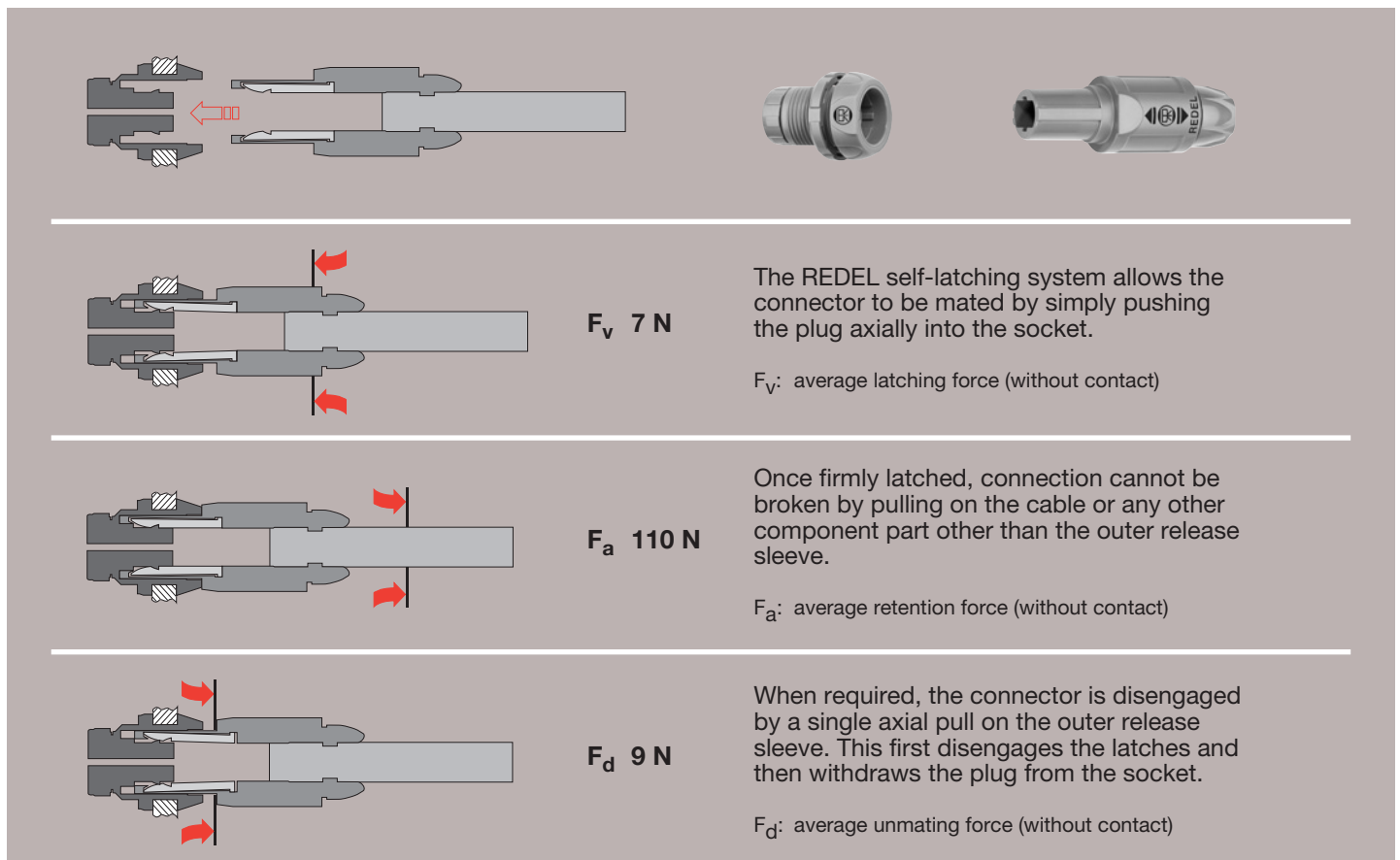
This self-latching system is renowned worldwide for its easy and quick mating and unmating features. It provides absolute security against vibration, shock or pull on the cable, and facilitates operation in a very limited space.

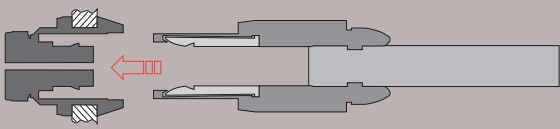

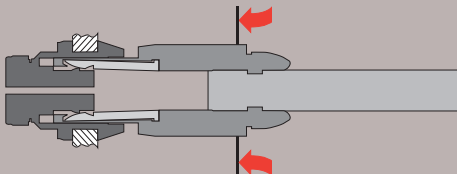
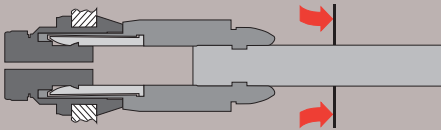
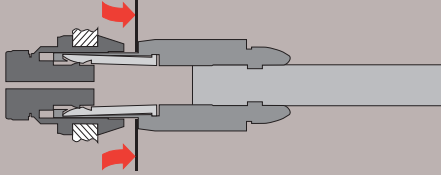
	
	<p>F_v 7 N</p> <p>The REDEL self-latching system allows the connector to be mated by simply pushing the plug axially into the socket.</p> <p>F_v: average latching force (without contact)</p>
	<p>F_a 110 N</p> <p>Once firmly latched, connection cannot be broken by pulling on the cable or any other component part other than the outer release sleeve.</p> <p>F_a: average retention force (without contact)</p>
	<p>F_d 9 N</p> <p>When required, the connector is disengaged by a single axial pull on the outer release sleeve. This first disengages the latches and then withdraws the plug from the socket.</p> <p>F_d: average unmating force (without contact)</p>

UL Recognition

REDEL connectors are recognized by the Underwriters Laboratories (UL). The approval of the complete system (REDEL connector, cable and your equipment) will be easier because REDEL connectors are recognized.

CE Marking

CE marking  means that the appliance or equipment bearing it complies with the protection requirements of one or several European safety directives.

CE marking  applies to complete products or equipment, **but not to electromechanical components, such as connectors.**

RoHS

REDEL connector specifications conforms the requirements of the RoHS directive (2011/65/EU) of the European Parliament and the latest amendments. This directive specifies the restrictions of the use of hazardous substances in electrical and electronic equipment marketed in Europe.

Exploded view of the REDEL SP

Straight plug



Straight plug with bend relief



Fixed socket

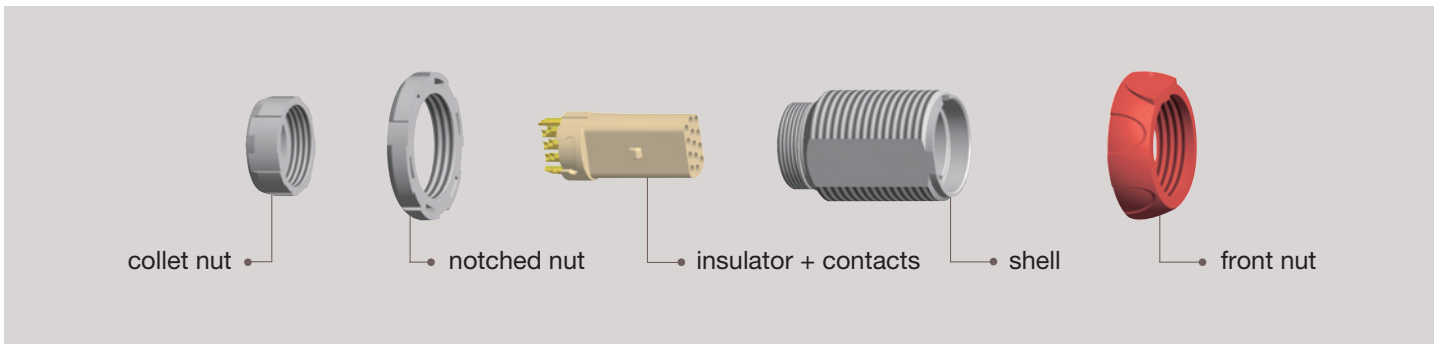

Free socket

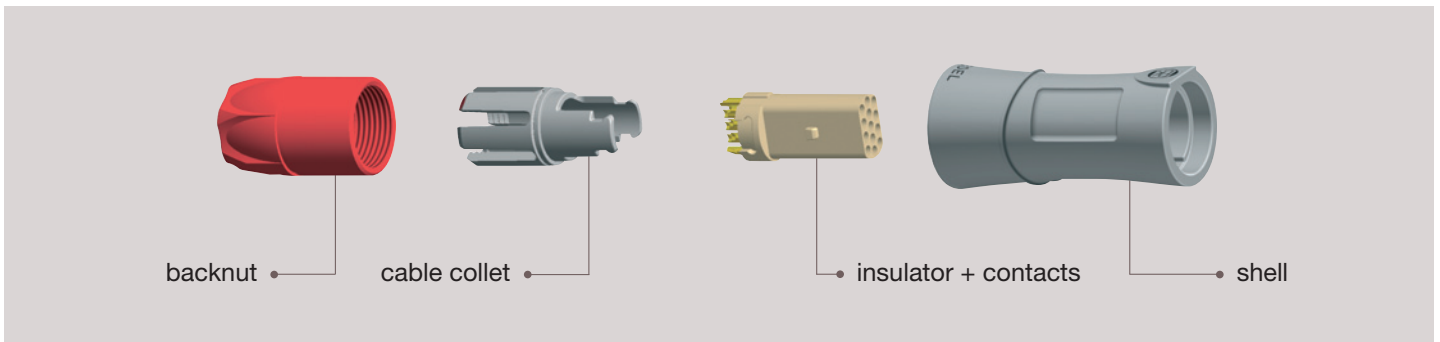

SP Series

The REDEL SP connectors are plastic Push-Pull connectors. These circular plastic connectors are especially adapted for applications such as medical electronics and test & measurement. The SP series offer additional features: the latch sleeve is recessed into the connector body ensuring greater shock resistance of the product.

The complete connector can be assembled from spare parts (even the contact configuration) therefore offering good flexibility in stock keeping. The outer shell in Proprietary sulfone enables extensive sterilisation cycles of the product. A large choice of bend relief is available in different colour and size. REDEL SP series connectors are not compatible with the REDEL 1P or 2P series.

Features & Benefits

- Plastic shell made of Proprietary sulfone
- Blind mating, scoop proof
- Extended resistance to sterilisation
- Enhanced ergonomics «hand grip»
- Increased resistance to shock
- New patented Push-Pull system

Applications

- Medical electronics
- Test & measurement
- Industrial electronics
- Automotive

Standard models

Straight plugs

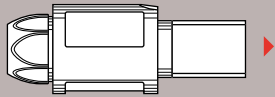

SA ●

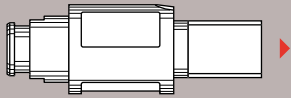

SA ●

Fixed sockets

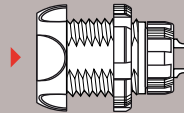

SL ●

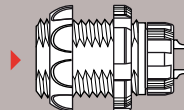

SK ●

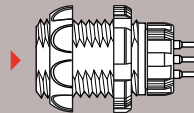

SK ●

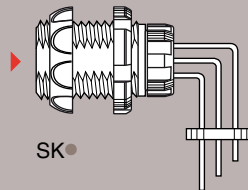

SK ●

Free sockets

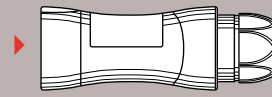

SR ●

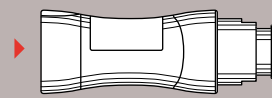

SR ●

Part numbering system

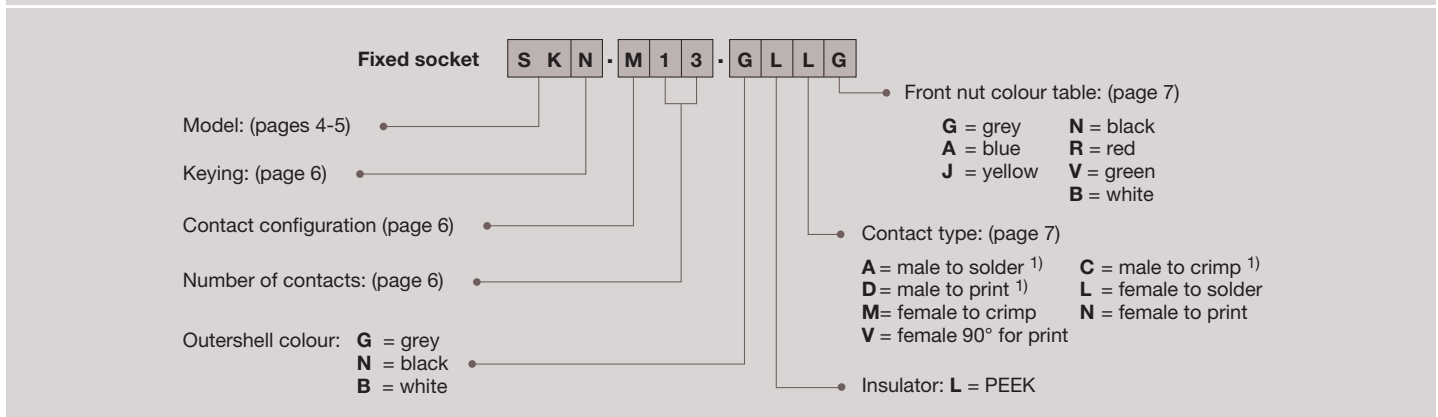
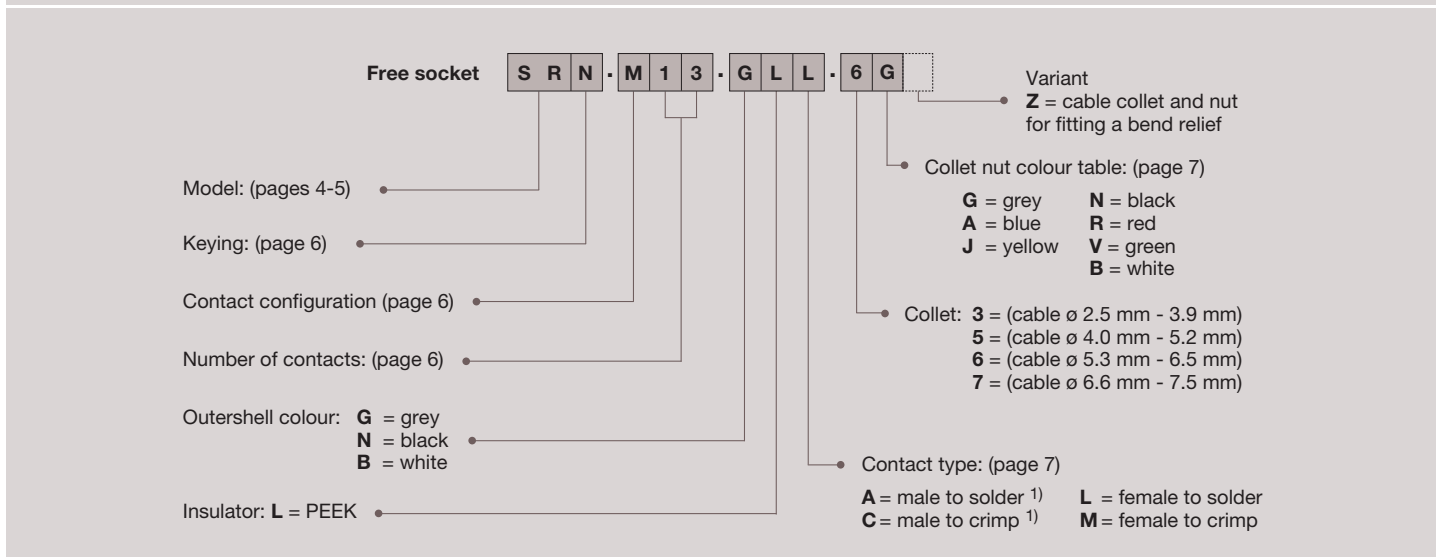
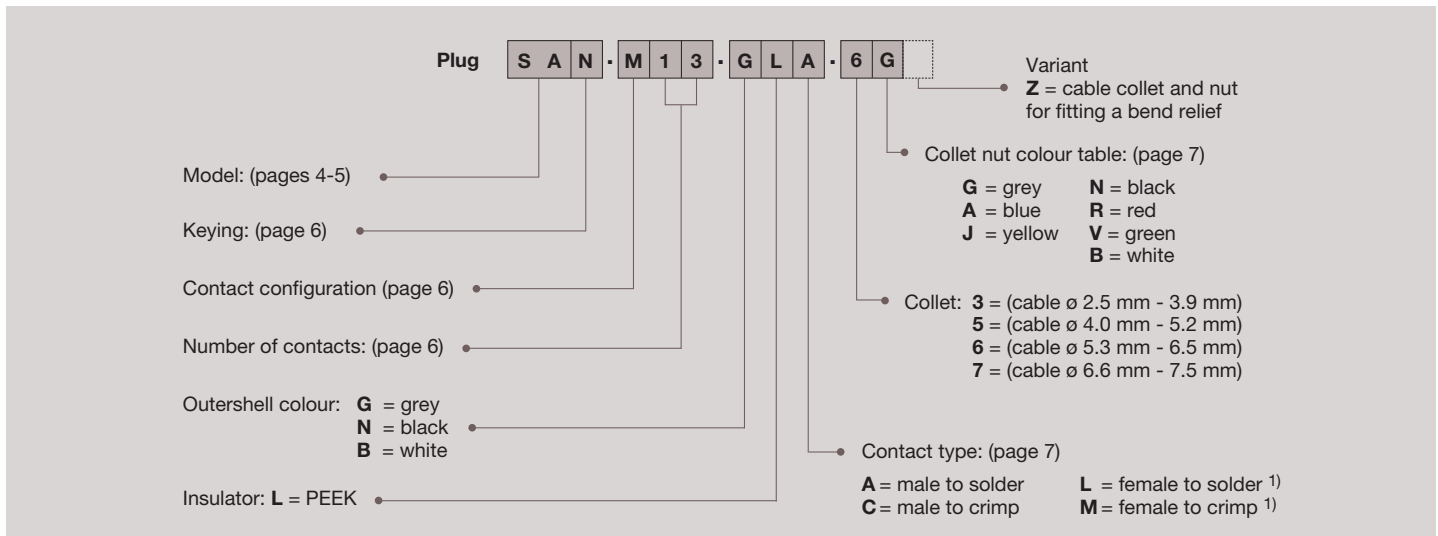
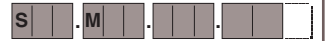

SAN.M13.GLA.6G Straight plug with cable collet and alignment key (N), multipole type with 13 male contacts to solder, grey Proprietary sulfone shell, PEEK insulator, collet for max cable ø 6.5 mm and grey collet nut.

SRN.M13.GLL.6G Free socket with cable collet and alignment key (N), multipole type with 13 female contacts to solder, grey Proprietary sulfone shell, PEEK insulator, collet for max cable ø 6.5 mm and grey collet nut.

SKN.M13.GLLG Fixed socket with two nuts and alignment key (N), multipole type with 13 female contacts to solder, grey Proprietary sulfone shell, PEEK insulator and grey plastic front nut.

Note: ¹⁾ contacts delivered only with S or T keying (inverted contacts).

Standard models (IP50)



Fixed socket

- 1 Outershell
- 2 Insulator
- 3 Female contact
- 4 Notched nut
- 5 Front nut
- 6 Collet nut



Straight plug

- 1 Outershell
- 2 latch sleeve
- 3 Backnut
- 4 Insulator
- 5 Contact
- 6 Cable collet

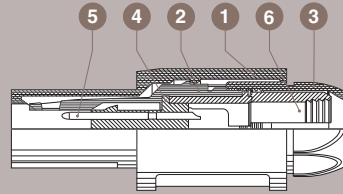

Characteristics	Value	Standards
Average retention force when pulling on the cable 1N = 0.102 kg	110	IEC 60512-8 test 15f
Cable retention force (depends on cable construction) 1N = 0.102 kg	~130	IEC 60512-9 test 17c

Characteristics	Value	Standards
Endurance (latching)	> 2000 cycles	IEC 60512-5 test 9a
Working temperature range (Proprietary sulfone)	-50/+170°C	-

SAN Straight plug, key (N) or keys (P, S and T), with cable collet



Part Number	Cable ø	
	min	max
SAN.M●●.GLA.3G	2.5	3.9
SAN.M●●.GLA.5G	4.0	5.2
SAN.M●●.GLA.6G	5.3	6.5
SAN.M●●.GLA.7G	6.6	7.5

Note: replace ●● by contact configuration (see page 6).

SAN Straight plug, key (N) or keys (P, S and T), with cable collet and nut for fitting a bend relief



Part Number	Cable ø	
	min	max
SAN.M●●.GLA.3GZ	2.5	3.9
SAN.M●●.GLA.5GZ	4.0	5.2
SAN.M●●.GLA.6GZ	5.3	6.5
SAN.M●●.GLA.7GZ	6.6	7.5

Note: replace ●● by contact configuration (see page 6). The bend relief must be ordered separately (see page 10).

SLN Fixed socket, key (N) or keys (P, S and T), nut fixing

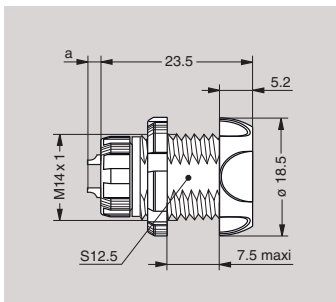

Part Number	Contact	
	Solder	Crimp
	a max (mm)	a (mm)
SLN.M●●.GLLG	2.2	0

Note: replace ●● by contact configuration (see page 6).

Note: all dimensions are in millimeters.

SKN Fixed socket, key (N) or keys (P, S and T) with two nuts (back panel mounting)



Part Number	Contact	
	Solder a max (mm)	Crimp a (mm)
SKN.M●●.GLLG	2.2	0

Note: replace ●● by contact configuration (see page 6).

SKN Fixed socket, key (N) or keys (P, S and T) with two nuts (back panel mounting) and with straight print contact

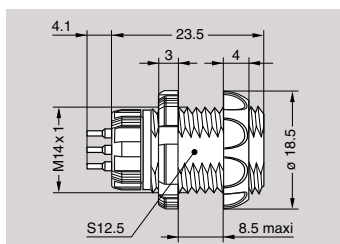

Part Number
SKN.M●●.GLNG

Note: replace ●● by contact configuration (see page 6).

SKN Fixed socket, key (N) or keys (P, S and T) with two nuts (back panel mounting) and with elbow print contact

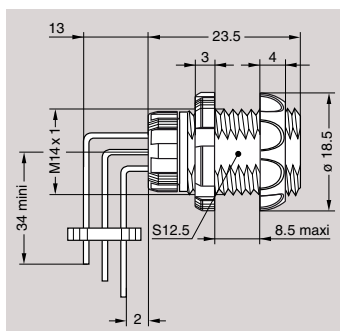

Part Number
SKN.M●●.GLVG

Note: replace ●● by contact configuration (see page 6).

SRN Free socket, key (N) or keys (P, S and T), with cable collet

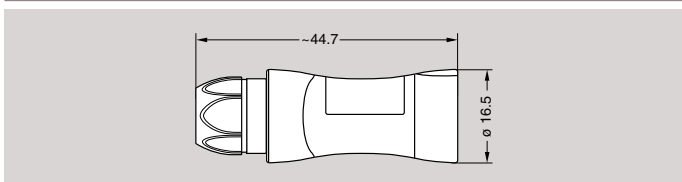

Part Number	Cable ø	
	min	max
SRN.M●●.GLL.3G	2.5	3.9
SRN.M●●.GLL.5G	4.0	5.2
SRN.M●●.GLL.6G	5.3	6.5
SRN.M●●.GLL.7G	6.6	7.5

Note: replace ●● by contact configuration (see page 6).

SRN Free socket, key (N) or keys (P, S and T), with cable collet and nut for fitting a bend relief

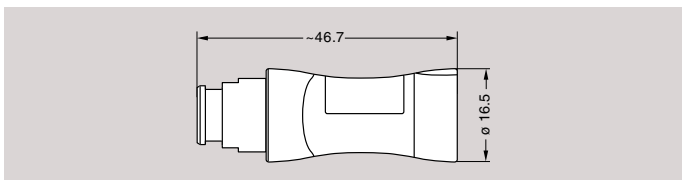

Part Number	Cable ø	
	min	max
SRN.M●●.GLL.3GZ	2.5	3.9
SRN.M●●.GLL.5GZ	4.0	5.2
SRN.M●●.GLL.6GZ	5.3	6.5
SRN.M●●.GLL.7GZ	6.6	7.5

Note: replace ●● by contact configuration (see page 6). The bend relief must be ordered separately (see page 10).

Note: all dimensions are in millimeters.

Alignment key



Verify the third digit of the part number in order to select the right keying. The standard keying is «N» coded.

Keying (plug front view)				
	N	P	S	T
Reference				
Contact type for plug	male	male	female	female
Contact type for socket	female	female	male	male

Insert configuration



	Male solder contacts	Female solder contacts	Reference	Number of contacts	Contact ϕ A (mm)	Solder bucket ϕ (mm) ⁴⁾	Crimp bucket ϕ (mm) ⁴⁾	AWG max-min	Contact type		Solder			Crimp		
									Solder / Crimp / Print (straight)	Print (elbow)	Test voltage (kV rms) ¹⁾ Contact-contact	Air clearance min ²⁾ (mm) Creepage distance min ³⁾ (mm)	Rated current (A)	Test voltage (kV rms) ¹⁾ Contact-contact	Air clearance min ²⁾ (mm) Creepage distance min ³⁾ (mm)	Rated current (A)
Multipole			M04	4	1.3	1.10	1.40	18 ⁴⁾ 20 22	•	•	1.60	0.95	11.5	1.80	1.35	11.5
			M06	6	0.9	0.80	1.10	20 22 24	•	•	1.50	1.20	8.5	1.90	1.50	8.5
			M08	8	0.9	0.80	1.10	20 22 24	•	•	1.50	0.75	5.0	1.50	1.1	5.0
			M10	10	0.7	0.80	0.80	22 ⁴⁾ 24 26	•	•	1.15	0.70	4.2	1.50	1.1	4.2
			M13	13	0.7	0.80	0.80	22 ⁴⁾ 24 26	•	•	1.05	0.50	4.0	1.30	0.9	4.0
			M16	16	0.5	0.45	0.45	28 30 32	•	-	0.75	0.47	3.0	1.30	0.8	3.0
			M18	18	0.5	0.45	0.45	28 30 32	•	-	0.75	0.47	2.5	1.15	0.8	2.5
			M22	22	0.5	0.45	0.45	28 30 32	•	-	0.60	0.48	2.0	1.30	0.8	1.2

Note: 1) depending on specific application and related standard, more restrictive operating voltage may apply. We suggest operating voltage = 1/3 test voltage, see page 15.

2) shortest distance in air between two conductive parts.

3) shortest distance along the surface of the insulating material between two conductive parts.

4) for a given AWG, the diameter of some stranded conductor design is larger than the solder cup diameter (see page 14).

Outer shell material S | | . M | | . | | . | | . | |

Material	Ref.	Colour	Temperature
Proprietary sulfone	G	Grey	-50° / +170°C
	N	Black	
	B	White	

Note: adapted for sterilisation saturated steam (120°C or 134°C).

Contact type S | | . M | | . | | . | | . | |

Select the type of contact: solder or crimp?

Plug

Type	Male	Female
solder	A	L ¹⁾
crimp	C	M ¹⁾

Socket

Type	Male	Female
solder	A ¹⁾	L
crimp	-	M
print	D ¹⁾	N
print 90°	-	V

Note: 1) only for S or T keying.

When should I use crimp rather than solder contacts ?

Soldering

- recommended for small volumes
- requires little amount of tooling (soldering iron)
- requires more time

Crimping

- recommended for large volumes
- no heat is required to make the connection
- for contacts with high density
- for use in high temperature environment (max. 170°C)
- requires extra tooling (crimping tools)

Colour coding S | | . M | | . | | . | | . | |

	Colours						
	grey	blue	yellow	black	red	green	white
Reference	G	A	J	N	R	V	B
RAL code	7001	5015	1016	9005	3020	6019	9003

Note: the RAL colours are indicative and depend on raw material and production process. Colour may differ.

Easy identification with the assistance of colour coding. Outershell is only available in grey, black or white.

Accessories

SAN / SLN Insulator and male or female crimp contacts



Contact configuration	nb. of contacts	ø contact (mm)	Kit contact part number	Kit contact part number
			Male	Female
M04	4	1.3	SAN.M04.ZLC	SLN.M04.ZLM
M06	6	0.9	SAN.M06.ZLC	SLN.M06.ZLM
M08	8	0.9	SAN.M08.ZLC	SLN.M08.ZLM
M10	10	0.7	SAN.M10.ZLC	SLN.M10.ZLM
M13	13	0.7	SAN.M13.ZLC	SLN.M13.ZLM
M16	16	0.5	SAN.M16.ZLC	SLN.M16.ZLM
M18	18	0.5	SAN.M18.ZLC	SLN.M18.ZLM
M22	22	0.5	SAN.M22.ZLC	SLN.M22.ZLM

SAN / SLN Insulator with male or female solder contacts



Contact configuration	nb. of contacts	ø contact (mm)	Kit contact part number	Kit contact part number
			Male	Female
M04	4	1.3	SAN.M04.ZLA	SLN.M04.ZLL
M06	6	0.9	SAN.M06.ZLA	SLN.M06.ZLL
M08	8	0.9	SAN.M08.ZLA	SLN.M08.ZLL
M10	10	0.7	SAN.M10.ZLA	SLN.M10.ZLL
M13	13	0.7	SAN.M13.ZLA	SLN.M13.ZLL
M16	16	0.5	SAN.M16.ZLA	SLN.M16.ZLL
M18	18	0.5	SAN.M18.ZLA	SLN.M18.ZLL
M22	22	0.5	SAN.M22.ZLA	SLN.M22.ZLL

SA●.100.●ZZ Plug outershell kit (no contacts)

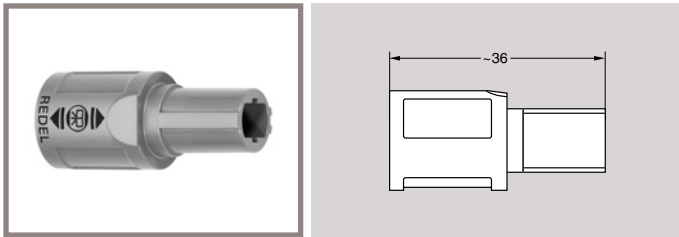

Part Number	Colours
SA●.100.GZZ	grey
SA●.100.BZZ	white
SA●.100.NZZ	black

Note: replace ● by alignment key (N, P, S or T).

SR●.200.●● Free socket outershell kit (no contacts)

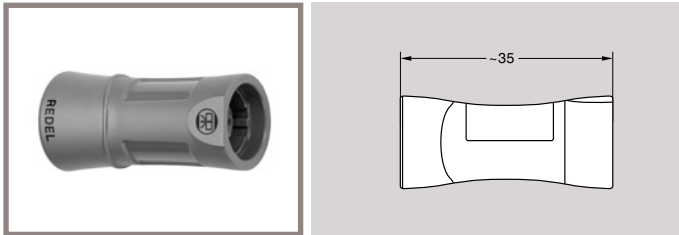

Part Number	Colours
SR●.200.RG	grey
SR●.200.RB	white
SR●.200.RN	black

Note: replace ● by alignment key (N, P, S or T).

SL●.200.●ZZ Socket outershell kit (nut fixing), (no contacts)

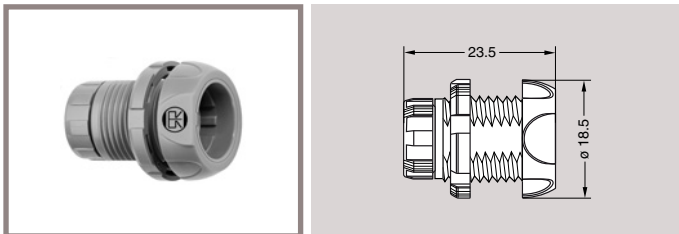

Part Number	Colours
SL●.200.GZZG	grey
SL●.200.BZZB	white
SL●.200.NZZN	black

Note: replace ● by alignment key (N, P, S or T).

SK●.200.●ZZ● Socket outershell kit (with two nuts), (no contacts)

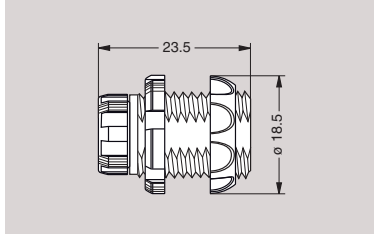

Part Number	Colours
SK●.200.GZZG	grey
SK●.200.BZZB	white
SK●.200.NZZN	black

Note: replace ● by alignment key (N, P, S or T).

SAN Collet

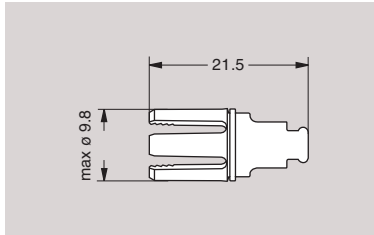

Part Number	Cable ϕ (mm)	
	min.	max.
SAN.739.RG	2.5	3.9
SAN.752.RG	4.0	5.2
SAN.765.RG	5.3	6.5
SAN.775.RG	6.6	7.5

SAM.130.●● Nut for fitting a GMA.1B bend relief

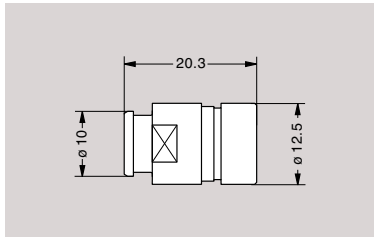

Part Number	Colours
SAM.130.RG	grey
SAM.130.RB	white
SAM.130.RN	black

Note: only for SA●, SR● models.

SAN.130.●● Collet nut

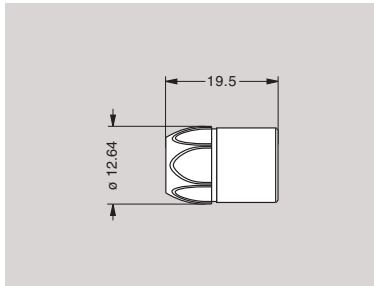

Part Number	Colours
SAN.130.RG	grey
SAN.130.RB	white
SAN.130.RR	red
SAN.130.RN	black
SAN.130.RJ	yellow
SAN.130.RA	blue
SAN.130.RV	green

Note: only for SA●, SR● models.

SLN Notched nut

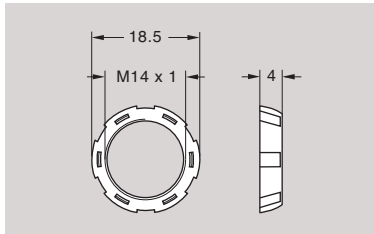

Part Number	Colours
SLN.240.RG	grey

SLN Collet nut

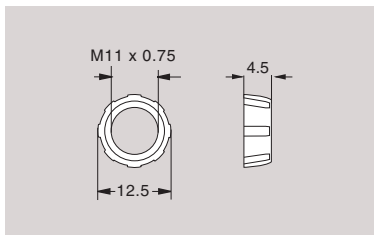

Part Number	Colours
SLN.230.RG	grey

Note: all dimensions are in millimeters.

SLN Plastic front nut for SL● models



Part Number	Colours
SLN.220.RG	grey
SLN.220.RB	white
SLN.220.RR	red
SLN.220.RN	black
SLN.220.RJ	yellow
SLN.220.RA	blue
SLN.220.RV	green

SKN Plastic front nut for SK● models



Part Number	Colours
SKN.220.RG	grey
SKN.220.RB	white
SKN.220.RR	red
SKN.220.RN	black
SKN.220.RJ	yellow
SKN.220.RA	blue
SKN.220.RV	green

GMA.1B Bend relief



A bend relief absorbs the angular force that may be exerted on cables.

These are designed for plugs and free sockets with cable collet and nut.

The Colours of these bend reliefs are not identical to the RAL colours of the socket's front nut.

Part Number	Dimensions (mm)				Material	Temperature range	
	Bend relief		Cable ø			in dry atmosphere	in water steam
	A	L	max.	min.			
GMA.1B.025.DG	2.5	30	2.9	2.5	TPU (Thermoplastic Polyurethane)	-40°C, +80°C	-
GMA.1B.030.DG	3.0	30	3.4	3.0			
GMA.1B.035.DG	3.5	30	3.9	3.5			
GMA.1B.040.DG	4.0	30	4.4	4.0			
GMA.1B.045.DG	4.5	30	4.9	4.5			
GMA.1B.054.DG	5.4	30	6.0	5.4			
GMA.1B.065.DG	6.5	30	7.0	6.5			
GMA.1B.025.RG	2.5	34	2.9	2.5	Silicone elastomer VMQ	-60°C, +200°C	+140°C
GMA.1B.030.RG	3.0	34	3.4	3.0			
GMA.1B.035.RG	3.5	34	3.9	3.5			
GMA.1B.040.RG	4.0	34	4.4	4.0			
GMA.1B.045.RG	4.5	34	5.0	4.5			
GMA.1B.051.RG	5.1	34	5.6	5.1			
GMA.1B.057.RG	5.7	34	6.2	5.7			
GMA.1B.063.RG	6.3	34	7.0	6.3			

Reference	Colours
A	blue
B	white
G	grey
J	yellow
M	brown
N	black
R	red
S	orange
V	green

Note: the selection of pigments, which should remain stable at high temperature, is limited by the new regulations. For this reason, some colours will be a shade different from those used for TPU bend reliefs. The selected solutions represent the best possible compromise.

Note: the last letter «G» of the part number indicates a grey colour, see the adjacent table and replace letter «G» by the letter of the colour required. All dimensions are in millimeters.

Tooling

SOP.019.HN Spanners with notch for securing the notched nut

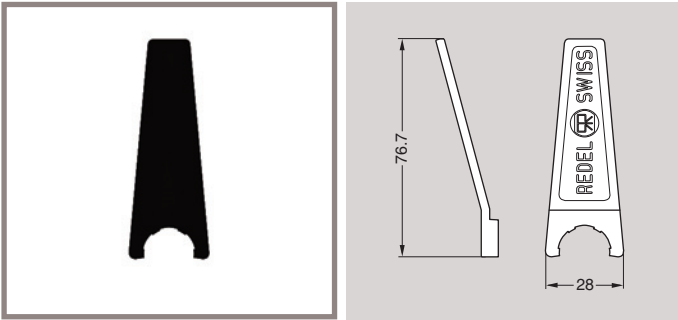

Material: Black polyamide. For notched nut SLN.240.RG.

SOB.186.GN Spanners for nut SLN.220R●
SOB.187.GN Spanners for nut SKN.220R●

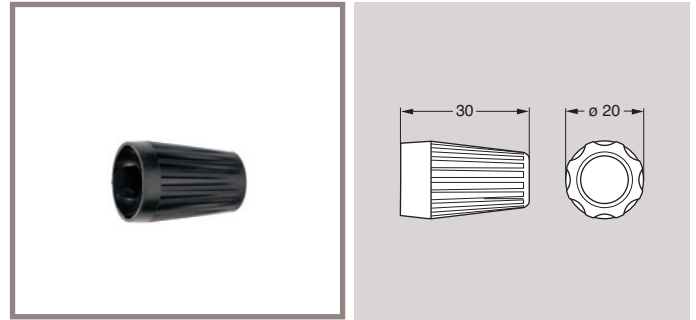

Material: Black polyamide

DPC.91.701.V Crimping tool

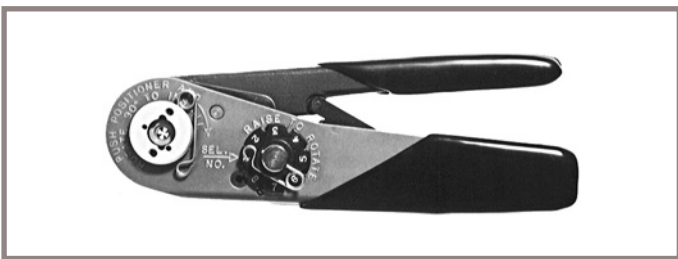

SOE Positioners for crimp contacts

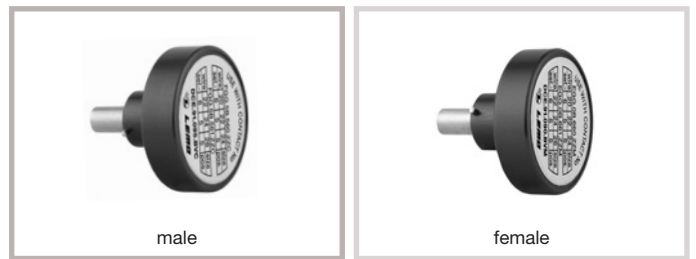

DCF Automatic extraction tools for crimp contacts

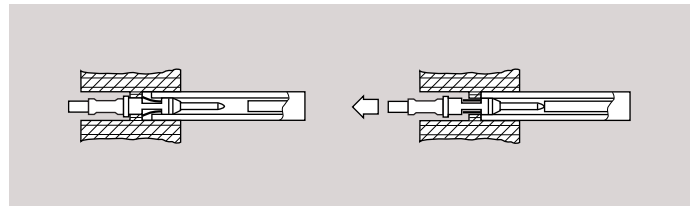
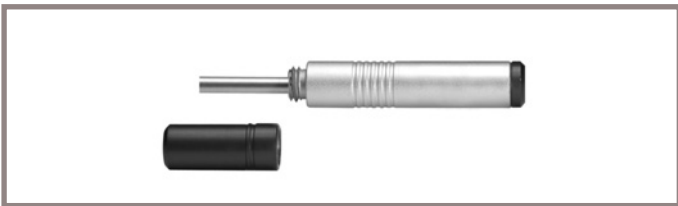

Configuration	Contact ø (mm)	Conductor AWG	Positioner part number		Selector No Setting	Part number extractor	
			Male contact	Female contact		Male contact	Female contact
M04	1.3	18-20	SOE.130.VC	SOE.130.VM	8-7	DCF.93.131.4LT	DCF.93.131.4LT
M06/M08	0.9	20-22-24	SOE.090.VC	SOE.090.VM	6-5-5	DCF.93.090.4LT	DCF.93.090.4LT
M10/M13	0.7	22-24-26	SOE.070.VC	SOE.070.VM	6-5-5	DCF.93.070.4LT	DCF.93.070.4LT
M16/M18/M22	0.5	28-30-32	SOE.050.VC	SOE.050.VM	4-3-3	DCF.91.050.2LT ¹⁾	DCF.91.050.2LT ¹⁾

Note: the variance in conductor stranding diameter for the minimum AWG is such that some can have a cross section which is not sufficient to guarantee crimping as per IEC 60352-2 standard. 1) With this extractor, the user must remove the insulator from the outer shell.

DCK Retention testing tools for crimp contacts

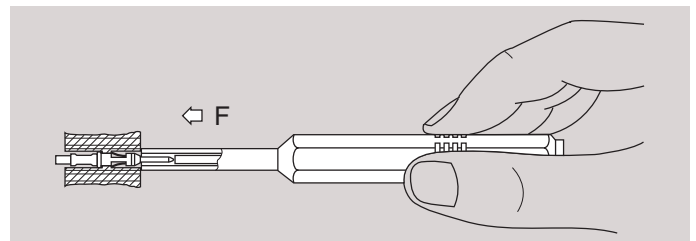
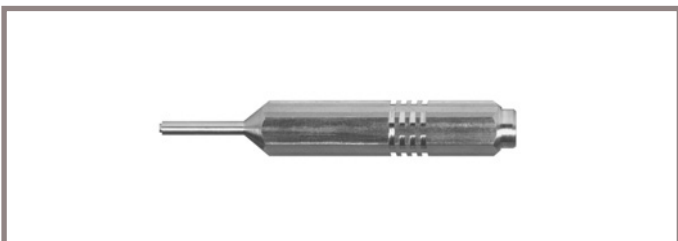

Contact ø (mm)	Test force (N)	Testing tool part number	
		Male contact	Female contact
0.5	8	DCK.91.050.8LRC	DCK.91.050.8LRM
0.7	10	DCK.91.071.0LRC	DCK.91.071.0LRM
0.9	14	DCK.91.091.4LRC	DCK.91.091.4LRM
1.3	25	DCK.91.132.5LRC	DCK.91.132.5LRM

Note: all dimensions are in millimeters

Panel hole

For SL● and SK●

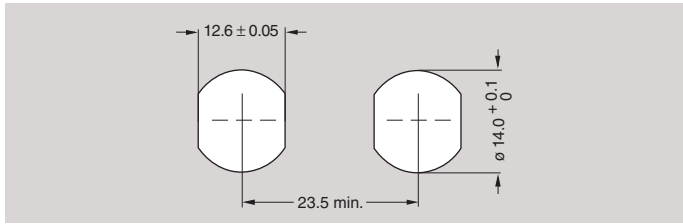

Note: Socket mounting nut torque = 1 Nm.
All dimensions are in millimeters.

PCB drilling pattern

For straight contacts

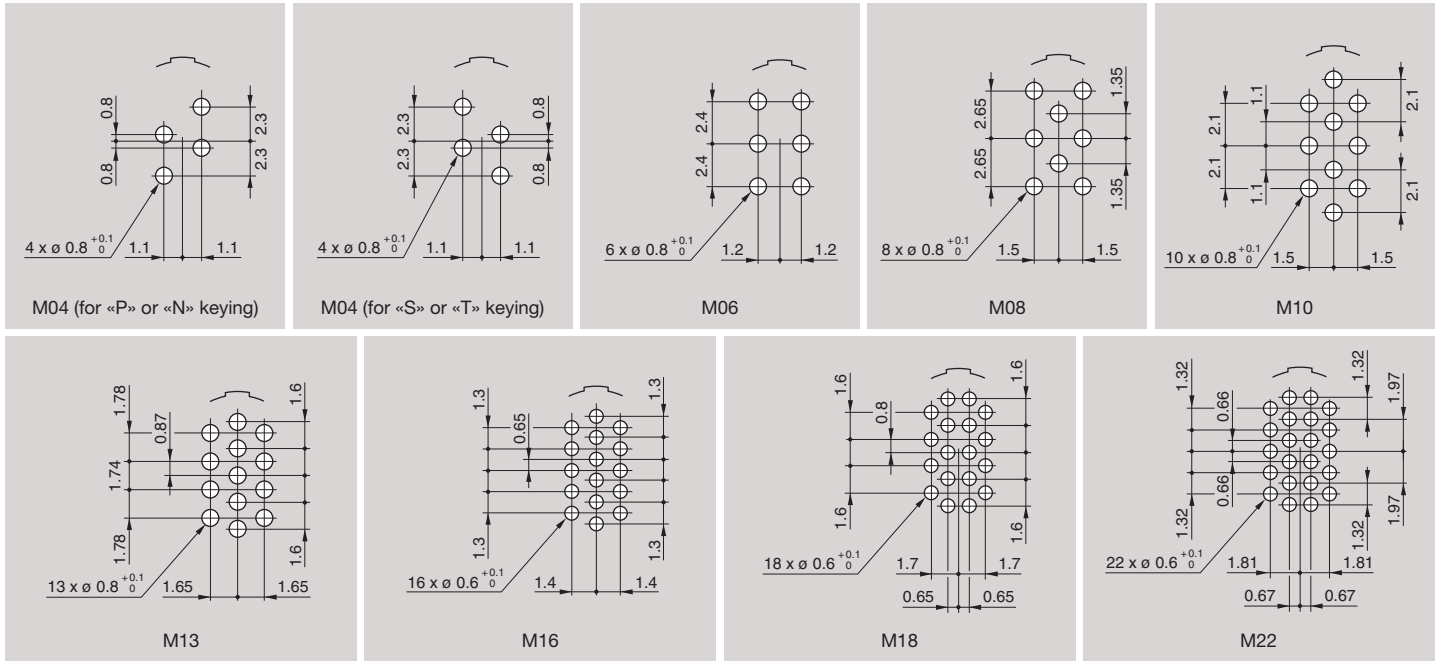

For elbow contacts

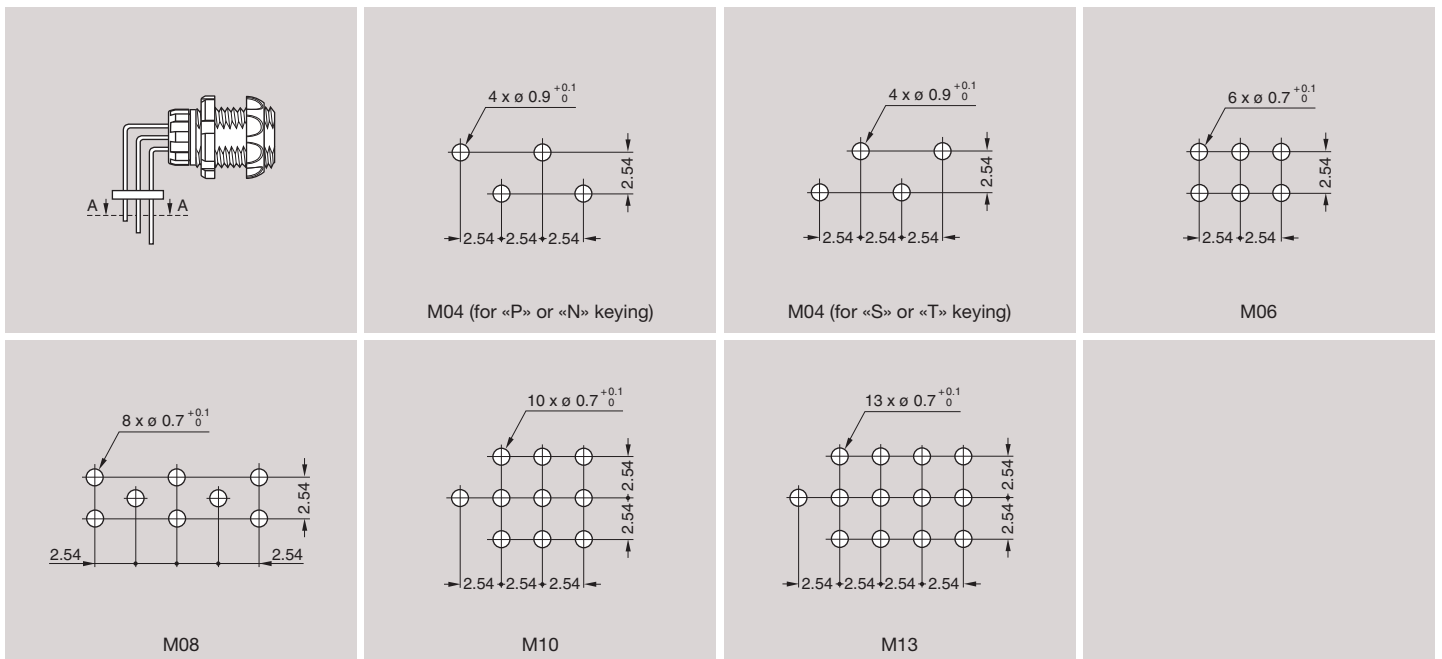

Note: all dimensions are in millimeters

Assembly instructions

Solder contacts / Crimp contacts

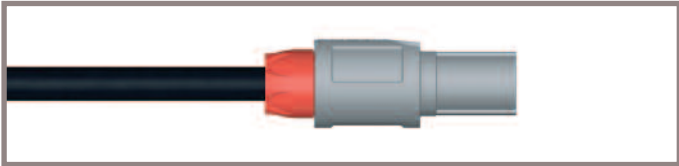
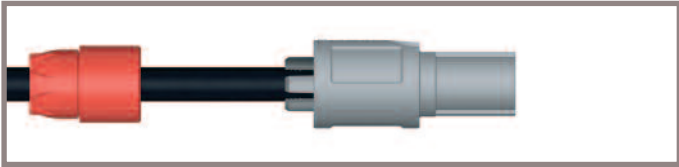
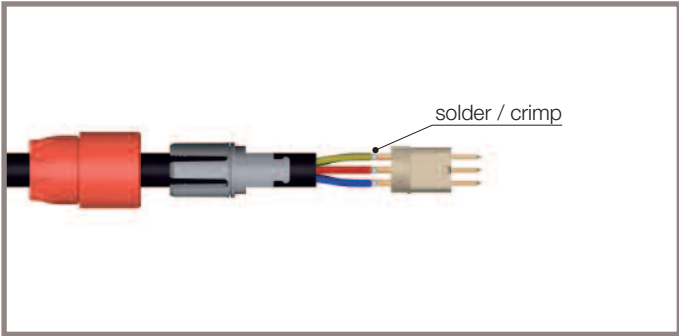

1. Slide the collet nut ① and then the collet ② onto the cable.

Configuration	Dimensions (mm)			
	Solder contacts		Crimp contacts	
	L	T	L	T
M04	11.5	3.5	15.0	3.5
M06, M08	13.0	3.0	15.0	3.5
M10, M13	13.0	3.0	15.0	3.5
M16 to M22	12.5	2.5	14.5	2.5

2. Strip the cable according to the lengths given in the table. Tin the conductors.

3. Solder conductors into contacts, starting with the center contacts, making sure that neither solder nor flux gets onto the insulator or cable insulation.

Fix the appropriate positioner in the crimping tool. Set selector to the number corresponding to the conductor AWG as indicated on the positioner label. Fit conductor into contact and make sure it is visible through the inspection hole in the crimp barrel. Slide conductor-contact combination into the open crimping tool; make sure that the contact is fully pushed into the positioner. Close the tool. Remove from crimping tool and check that conductor is secure in contact and shows in inspection hole.

4. Slide the collet ② forward and locate both tags ③ in the slots ⑤ on the insulator ⑥. Push collet ② and insulator ⑥ assembly into the shell ⑦ whilst turning it to ensure that the tag ③ locates in the inside slot of the shell.

5. Slide collet nut ① over collet ② and tighten the collet nut ① to the maximum torque of 0.3 Nm.

– Socket mounting nut torque = 1 Nm.

Technical tables

Table of American Wire Gauge

AWG	Construction		ø wire max		Wire section	
	Strand nb	AWG/strand	(mm)	(in)	(mm ²)	(sq in)
0	259	24	11.277	0.444	52.90	0.0820
1	817	30	9.702	0.382	41.40	0.0641
2	259	26	8.89	0.35	33.20	0.0514
4	133	25	6.9596	0.274	21.5925	0.0335
6	133	27	5.5118	0.217	13.5885	0.0211
8	168	30	4.4450	0.175	8.5127	0.0132
8	133	29	4.3942	0.173	8.6053	0.0133
10	105	30	3.3020	0.13	5.3204	0.0082
10	37	26	2.9210	0.115	4.7397	0.0073
10	1	10	2.6162	0.103	5.2614	0.0082
12	37	28	2.3114	0.091	2.9765	0.0046
12	19	25	2.3622	0.093	3.0847	0.0048
12 ¹⁾	7	20	2.5400	0.10	3.6321	0.0056
12	1	12	2.0828	0.082	3.3081	0.0051
14	41	30	2.0574	0.081	2.0775	0.0032
14	19	27	1.8542	0.073	1.9413	0.0030
14 ¹⁾	7	22	2.0828	0.082	2.2704	0.0035
14	1	14	1.6510	0.065	2.0820	0.0032
16 ¹⁾	65	34	1.5748	0.062	1.3072	0.0020
16	26	30	1.5748	0.062	1.3174	0.0020
16	19	29	1.4986	0.059	1.2293	0.0019
16 ¹⁾	7	24	1.5494	0.061	1.4330	0.0022
16	1	16	1.3208	0.052	1.3076	0.0020
18 ¹⁾	65	36	1.2700	0.05	0.8234	0.0013
18 ¹⁾	42	34	1.2700	0.05	0.8447	0.0013
18	19	30	1.3208	0.052	0.9627	0.0015
18	16	30	1.2954	0.051	0.8107	0.0013
18	7	26	1.2700	0.05	0.8967	0.0014
18	1	18	1.0414	0.041	0.8229	0.0013
20 ¹⁾	42	36	1.0160	0.04	0.5320	8.2x10 ⁻⁴
20	19	32	1.0414	0.041	0.6162	0.0010
20	10	30	1.0160	0.04	0.5067	7.9x10 ⁻⁴
20	7	28	0.9906	0.039	0.5631	8.7x10 ⁻⁴
20	1	20	0.8382	0.033	0.5189	8.0x10 ⁻⁴
22	19	34	0.8382	0.033	0.3821	5.9x10 ⁻⁴
22	7	30	0.7874	0.031	0.3547	5.5x10 ⁻⁴
22	1	22	0.6604	0.026	0.3243	5.0x10 ⁻⁴
24 ¹⁾	42	40	0.6604	0.026	0.2045	3.2x10 ⁻⁴
24	19	36	0.6858	0.027	0.2407	3.7x10 ⁻⁴
24	7	32	0.6350	0.025	0.2270	3.5x10 ⁻⁴
24	1	24	0.5588	0.022	0.2047	3.2x10 ⁻⁴
26	19	38	0.5588	0.022	0.1540	2.4x10 ⁻⁴
26	7	34	0.5080	0.02	0.1408	2.2x10 ⁻⁴
26	1	26	0.4318	0.017	0.1281	2.0x10 ⁻⁴
28 ¹⁾	19	40	0.4318	0.017	0.0925	1.4x10 ⁻⁴
28	7	36	0.4064	0.016	0.0887	1.4x10 ⁻⁴
28	1	28	0.3302	0.013	0.0804	1.2x10 ⁻⁴
30	7	38	0.3302	0.013	0.0568	8.8x10 ⁻⁵
30	1	30	0.2794	0.011	0.0507	7.9x10 ⁻⁵
32	7	40	0.2794	0.011	0.0341	5.3x10 ⁻⁵
32	1	32	0.2286	0.009	0.0324	5.0x10 ⁻⁵
34	1	34	0.1693	0.007	0.0201	3.1x10 ⁻⁵
36	1	36	0.127	0.005	0.0127	2.0x10 ⁻⁵
38	1	38	0.1016	0.004	0.0081	1.3x10 ⁻⁵
40	1	40	0.078	0.003	0.0049	7.5x10 ⁻⁶

Table of wire gauges according to IEC-60228 standard

Conductor no x ø (mm)	Max ø (mm)	Max ø (in)	Section (mm ²)	Section (sq in)
196x0.40	7.50	0.295	25.00	0.0387
7x2.14	6.10	0.240	25.00	0.0387
125x0.40	6.00	0.236	16.00	0.0248
7x1.72	4.90	0.192	16.00	0.0248
1x4.50	4.50	0.177	16.00	0.0248
80x0.40	4.70	0.155	10.00	0.0155
7x1.38	3.95	0.155	10.00	0.0155
1x3.60	3.60	0.141	10.00	0.0155
84x0.30	3.70	0.145	6.00	0.0093
7x1.50	3.15	0.124	6.00	0.0093
1x2.76	2.76	0.108	6.00	0.0093
56x0.30	2.80	0.110	4.00	0.0062
7x0.86	2.58	0.098	4.00	0.0062
1x2.25	2.25	0.082	4.00	0.0062
50x0.25	2.15	0.084	2.50	0.0038
7x0.68	2.04	0.080	2.50	0.0038
1x1.78	1.78	0.070	2.50	0.0038
30x0.25	1.60	0.062	1.50	0.0023
7x0.52	1.56	0.061	1.50	0.0023
1x1.4	1.40	0.055	1.50	0.0023
32x0.20	1.35	0.053	1.00	0.0015
7x0.43	1.29	0.050	1.00	0.0015
1x1.15	1.15	0.045	1.00	0.0015
42x0.15	1.20	0.047	0.75	0.0011
28x0.20	1.15	0.045	0.75	0.0011
1x1.0	1.00	0.039	0.75	0.0011
28x0.15	0.95	0.037	0.50	7.7x10 ⁻⁴
16x0.20	0.90	0.035	0.50	7.7x10 ⁻⁴
1x0.80	0.80	0.031	0.50	7.7x10 ⁻⁴
7x0.25	0.75	0.029	0.34	5.2x10 ⁻⁴
1x0.60	0.60	0.023	0.28	4.3x10 ⁻⁴
14x0.15	0.75	0.029	0.25	3.8x10 ⁻⁴
7x0.20	0.65	0.023	0.22	3.4x10 ⁻⁴
18x0.10	0.50	0.019	0.14	2.1x10 ⁻⁴
14x0.10	0.40	0.015	0.11	1.7x10 ⁻⁴
21x0.07	0.40	0.015	0.09	1.3x10 ⁻⁴
14x0.10	0.40	0.015	0.09	1.3x10 ⁻⁴

Note: 1) not included in the standard

Product safety notice

PLEASE READ AND FOLLOW ALL INSTRUCTIONS CAREFULLY AND CONSULT ALL RELEVANT NATIONAL AND INTERNATIONAL SAFETY REGULATIONS FOR YOUR APPLICATION. IMPROPER HANDLING, CABLE ASSEMBLY, OR WRONG USE OF CONNECTORS CAN RESULT IN HAZARDOUS SITUATIONS.

1. SHOCK AND FIRE HAZARD

Incorrect wiring, the use of damaged components, presence of foreign objects (such as metal debris), and / or residue (such as cleaning fluids), can result in short circuits, overheating, and / or risk of electric shock.

Mated components should never be disconnected while live as this may result in an exposed electric arc and local overheating, resulting in possible damage to components.

2. HANDLING

Connectors and their components should be visually inspected for damage prior to installation and assembly. Suspect components should be rejected or returned to the factory for verification.

Connector assembly and installation should only be carried out by properly trained personnel. Proper tools must be used during installation and / or assembly in order to obtain safe and reliable performance.

3. USE

Connectors with exposed contacts should never be live (or on the current supply side of a circuit). Under general conditions voltages above 30 VAC and 42 VDC are considered hazardous and proper measures should be taken to eliminate all risk of transmission of such voltages to any exposed metal part of the connector.

4. TEST AND OPERATING VOLTAGES

The maximum admissible operating voltage depends upon the national or international standards in force for the application in question. Air and creepage distances impact the operating voltage; reference values are indicated in the catalog however these may be influenced by PC board design and / or wiring harnesses.

The test voltage indicated in the catalog is 75% of the mean breakdown voltage; the test is applied at 500 V/s and the test duration is 1 minute.

5. CE MARKING

CE marking  means that the appliance or equipment bearing it complies with the protection requirements of one or several European safety directives.

CE marking  applies to complete products or equipment, **but not to electromechanical components, such as connectors.**

6. PRODUCT IMPROVEMENTS

The LEMO Group reserves the right to modify and improve to our products or specifications without providing prior notification.

Notes

LEMO complete product range

	B	S	K	E	F	00	01	0A	3T	4A	4M	3K.93C	1D	Y	05	5G	2G	2C	L	H	M	R	N	03	V	W	T7	P	D	K/S	01	DIN	
Unipole																																	
Multipole																																	
Coaxial 50 Ω																																	
Coaxial 75 Ω																																	
Multi Coaxial																																	
Mixed Coax + LV																																	
Triaxial 50 Ω																																	
Triaxial 75 Ω																																	
Mixed Triax + LV																																	
Quadrax																																	
High Voltage																																	
Multi High Voltage																																	
Mixed HV + LV																																	
Fibre Optic																																	
Multi Fibre Optic																																	
Mixed FO + LV																																	
Thermocouple																																	
Fluidic																																	
Multi Fluidic																																	
Mixed Fluidic + LV																																	

Most frequently used in darker colour

B Series Keyed	S Series	K Series Keyed	E Series	F Series Keyed	00 Series	01 Series
0A Series	3T Series	4A Series	4M Series Keyed	3K.93C Series Keyed	1D Series	Y Series
05 Series	5G Series Keyed	2G Series Keyed	2C Series	L Series Keyed	H Series	M Series Keyed
R Series Keyed	N Series Keyed	03 Series Keyed	V Series	W Series Keyed	Cable assembly	K/S Series Keyed
REDEL T7 Series	REDEL P Series Keyed	REDEL D Series	01 Series Keyed	VAA Series	SAA Series	TAA Series

LEMO HEADQUARTERS

SWITZERLAND

LEMO SA

Chemin des Champs-Courbes 28 - P.O. Box 194 - CH-1024 Ecublens
Tel. (+41 21) 695 16 00 - Fax (+41 21) 695 16 02 - e-mail: info@lemo.com

LEMO SUBSIDIARIES

AUSTRIA

LEMO Elektronik GesmbH

Lemböckgasse 49/E6-3
1230 Wien
Tel: (+43 1) 914 23 20 0
Fax: (+43 1) 914 23 20 11
sales@lemo.at

CANADA

LEMO Canada Inc

44 East Beaver Creek Road, unit 20
Richmond Hill, Ontario L4B 1G8
Tel: (+1 905) 889 56 78
Fax: (+1 905) 889 49 70
info-canada@lemo.com

CHINA / HONG KONG

LEMO Electronics (Shanghai) Co., Ltd

5th Floor, Block 6, City of ELITE,
1000 Jinhai Road, Pudong
Shanghai, China 201206
Tel: (+86 21) 5899 7721
Fax: (+86 21) 5899 7727
cn.sales@lemo.com

DENMARK

LEMO Denmark A/S

Gammel Mosevej 46
2820 Gentofte
Tel: (+45) 45 20 44 00
Fax: (+45) 45 20 44 01
info-dk@lemo.com

FRANCE

LEMO France Sàrl

24/28 Avenue Graham Bell
Bâtiment Balthus 4
Bussy Saint Georges
77607 Marne la Vallée Cedex 3
Tel: (+33 1) 60 94 60 94
Fax: (+33 1) 60 94 60 90
info-fr@lemo.com

GERMANY

LEMO Elektronik GmbH

Hanns-Schwindt-Str. 6
81829 München
Tel: (+49 89) 42 77 03
Fax: (+49 89) 420 21 92
info@lemo.de

HUNGARY

REDEL Elektronika Kft

Nagysándor József u. 6-12
1201 Budapest
Tel: (+36 1) 421 47 10
Fax: (+36 1) 421 47 57
info-hu@lemo.com

ITALY

LEMO Italia srl

Viale Lunigiana 25
20125 Milano
Tel: (+39 02) 66 71 10 46
Fax: (+39 02) 66 71 10 66
sales.it@lemo.com

JAPAN

LEMO Japan Ltd

2-7-22, Mita,
Minato-ku, Tokyo, 108-0073
Tel: (+81 3) 54 46 55 10
Fax: (+81 3) 54 46 55 11
lemoinfo@lemo.co.jp

NETHERLANDS / BELGIUM

LEMO Connectors Benelux

De Trompet 1060
1967 DA Heemskerk
Tel: (+31) 251 25 78 20
Fax: (+31) 251 25 78 21
info@lemo.nl

NORWAY / ICELAND

LEMO Norway A/S

Stanseveien 6B
0975 Oslo
Tel: (+47) 22 91 70 40
Fax: (+47) 22 91 70 41
info-no@lemo.com

SINGAPORE

LEMO Asia Pte Ltd

4 Leng Kee Road,
#06-09 SiS Building
Singapore 159088
Tel: (+65) 6476 0672
Fax: (+65) 6474 0672
sg.sales@lemo.com

SPAIN / PORTUGAL

IBERLEMO SAU

Brasil, 45, 08402 Granollers
Barcelona
Tel: (+34 93) 860 44 20
Fax: (+34 93) 879 10 77
info-es@lemo.com

SWEDEN / FINLAND

LEMO Nordic AB

Mariehällsvägen 39A
168 65 Bromma
Tel: (+46 8) 635 60 60
Fax: (+46 8) 635 60 61
info-se@lemo.com

SWITZERLAND

LEMO Verkauf AG

Grundstrasse 22 B
6343 Rotkreuz
Tel: (+41 41) 790 49 40
Fax: (+41 41) 790 49 43
ch.sales@lemo.com

UNITED KINGDOM

LEMO UK Ltd

12-20 North Street
Worthing, West Sussex, BN11 1DU
Tel: (+44 1903) 23 45 43
Fax: (+44 1903) 20 62 31
lemouk@lemo.com

USA

LEMO USA Inc

P.O. Box 2408
Rohnert Park, CA 94927-2408
Tel: (+1 707) 578 88 11
(+1 800) 444 53 66
Fax: (+1 707) 578 08 69
info@lemousa.com

LEMO DISTRIBUTORS

AUSTRALIA, BRAZIL, CHILE, CZECH REPUBLIC, GREECE, INDIA, ISRAEL,
NEW ZEALAND, PAKISTAN, POLAND, RUSSIA, SOUTH AFRICA,
SOUTH KOREA, TAIWAN, TURKEY, UKRAINE

www.lemo.com

Компания «Life Electronics» занимается поставками электронных компонентов импортного и отечественного производства от производителей и со складов крупных дистрибьюторов Европы, Америки и Азии.

С конца 2013 года компания активно расширяет линейку поставок компонентов по направлению коаксиальный кабель, кварцевые генераторы и конденсаторы (керамические, пленочные, электролитические), за счёт заключения дистрибьюторских договоров

Мы предлагаем:

- Конкурентоспособные цены и скидки постоянным клиентам.
- Специальные условия для постоянных клиентов.
- Подбор аналогов.
- Поставку компонентов в любых объемах, удовлетворяющих вашим потребностям.
- Приемлемые сроки поставки, возможна ускоренная поставка.
- Доставку товара в любую точку России и стран СНГ.
- Комплексную поставку.
- Работу по проектам и поставку образцов.
- Формирование склада под заказчика.
- Сертификаты соответствия на поставляемую продукцию (по желанию клиента).
- Тестирование поставляемой продукции.
- Поставку компонентов, требующих военную и космическую приемку.
- Входной контроль качества.
- Наличие сертификата ISO.

В составе нашей компании организован Конструкторский отдел, призванный помогать разработчикам, и инженерам.

Конструкторский отдел помогает осуществить:

- Регистрацию проекта у производителя компонентов.
- Техническую поддержку проекта.
- Защиту от снятия компонента с производства.
- Оценку стоимости проекта по компонентам.
- Изготовление тестовой платы монтаж и пусконаладочные работы.



Тел: +7 (812) 336 43 04 (многоканальный)
Email: org@lifeelectronics.ru