

# Analog Devices Welcomes Hittite Microwave Corporation

NO CONTENT ON THE ATTACHED DOCUMENT HAS CHANGED



**THIS PAGE INTENTIONALLY LEFT BLANK**



### Typical Applications

The HMC1106 is ideal for:

- Microwave Point-to-Point Radios
- VSAT & SATCOM
- Test Equipment & Sensors
- Military End-Use
- Automotive Radar

### Features

- Passive: No DC Bias Required
- Low LO Power: +15 dBm
- LO/RF Isolation: 38 dB
- LO/IF Isolation: 32 dB
- RF/IF Isolation: 25 dB
- Wide IF Bandwidth: DC to 24 GHz
- Die Size: 1.79 x 1.46 x 0.1 mm

### Functional Diagram

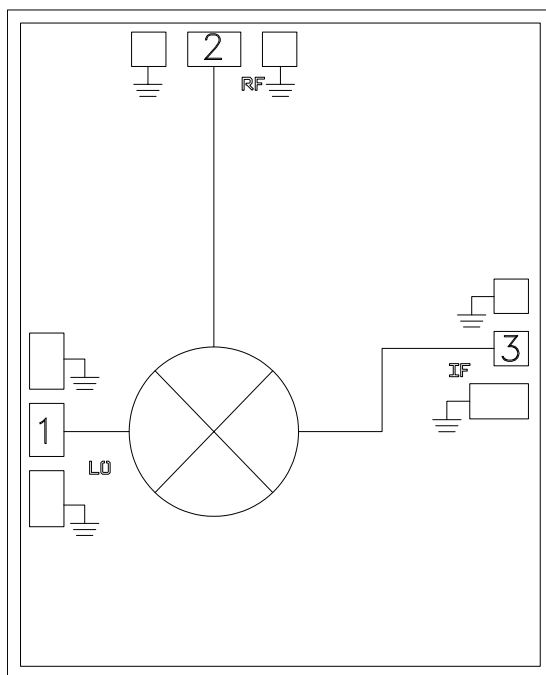

### General Description

The HMC1106 is a double-balanced mixer which can be used as a downconverter with DC to 24 GHz at the IF port, 20 to 50 GHz at the LO port, and 15 to 36 GHz at the RF port. This passive MMIC mixer is fabricated with GaAs Schottky diode technology. All bond pads and the die backside are Ti/Au metallized and the Schottky devices are fully passivated for reliable operation. All data shown herein is measured with the chip in a 50 Ohm environment and contacted with RF probes.

### Electrical Specifications, $T_A = +25^\circ \text{C}$ , LO = 36.1 GHz, LO = +15 dBm, LSB <sup>[1]</sup>

Parameter	Min.	Typ.	Max.	Min.	Typ.	Max.	Min.	Typ.	Max.	Units
RF Frequency Range	15 - 24			24 - 27			27 - 36			GHz
LO Frequency Range	20 - 50									GHz
IF Frequency Range	DC - 24									GHz
Conversion Loss		9	12		11	14		10	14	dB
LO to RF Isolation		38			38			38		dB
LO to IF Isolation <sup>[2]</sup>	25	32		25	32		25	32		dB
RF to IF Isolation <sup>[3]</sup>	15	22		15	18		15	25		dB
IP3 (Input)		16			16			22		dBm

[1] Unless otherwise noted, all measurements performed as downconverter with LO Frequency = 36.1 GHz and LO Power = +15 dBm

[2] Typical value = 22 dB at LO = 20 GHz

[3] Data taken with LO = 30 GHz



**Conversion Loss vs. Temperature**  
**LO = 36.1 GHz [1]**

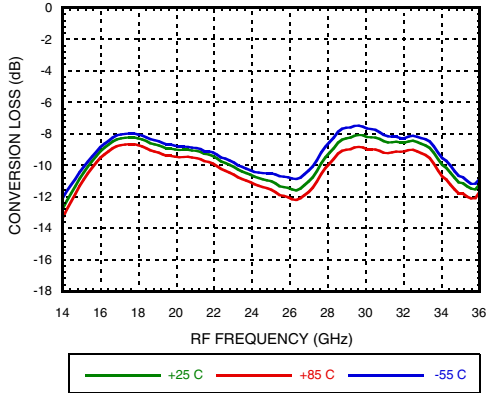

**Conversion Loss vs. LO Power**  
**LO = 36.1 GHz [1]**

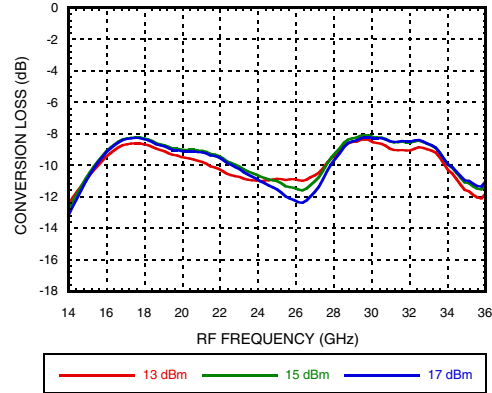

**Conversion Loss vs. Temperature**  
**IF = 12.1 GHz [2]**

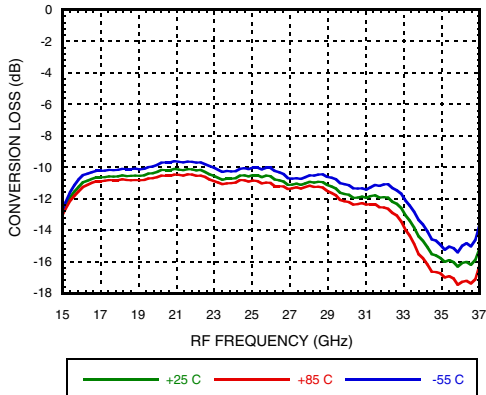

**Conversion Loss vs. LO Power**  
**IF = 12.1 GHz [2]**

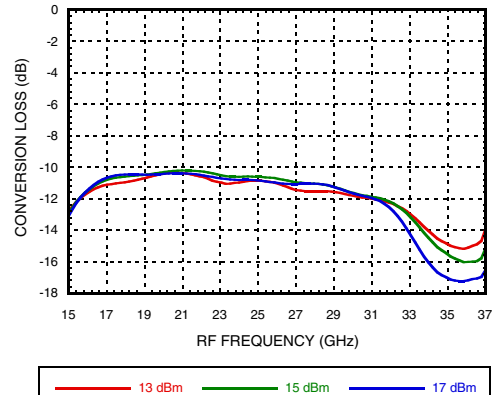

**Conversion Loss vs. Temperature**  
**IF = 16.1 GHz [2]**

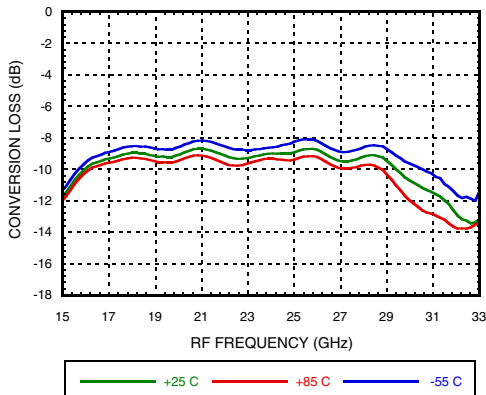

**Conversion Loss vs. LO Power**  
**IF = 16.1 GHz [2]**

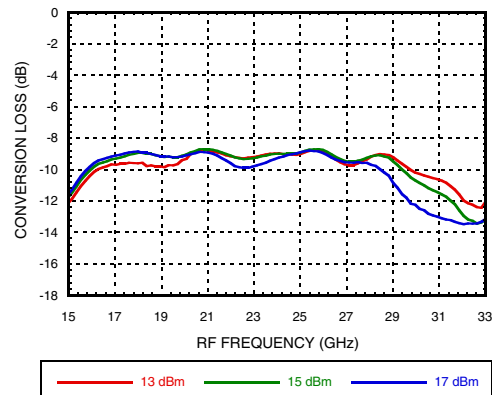

[1] Measurement taken at fixed LO frequency, LSB

[2] Measurement taken at fixed IF frequency, LSB



**Conversion Loss vs. IF <sup>[1]</sup>**

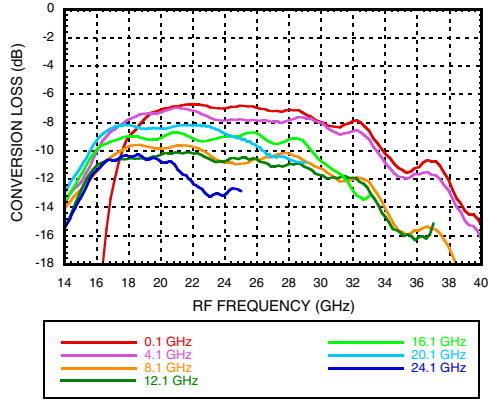

**Input IP3 vs. IF <sup>[1]</sup>**

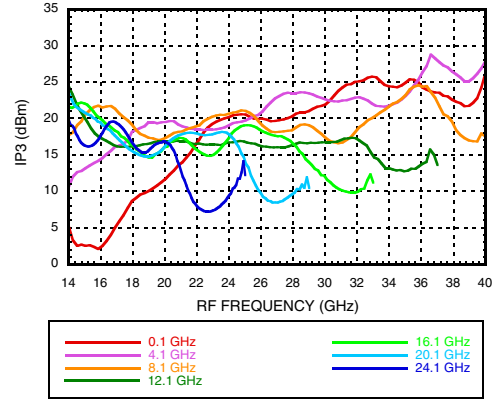

**Input IP3 vs. Temperature  
LO = 36.1 GHz <sup>[2]</sup>**

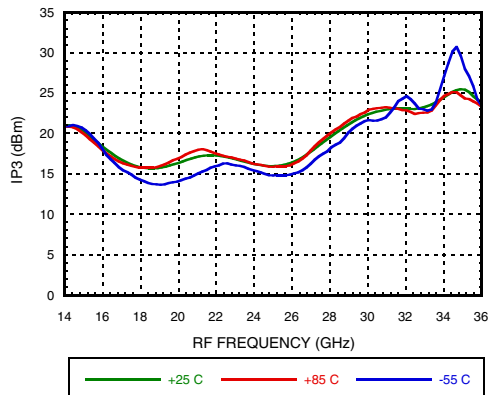

**Input IP3 vs. LO Power  
LO = 36.1 GHz <sup>[2]</sup>**

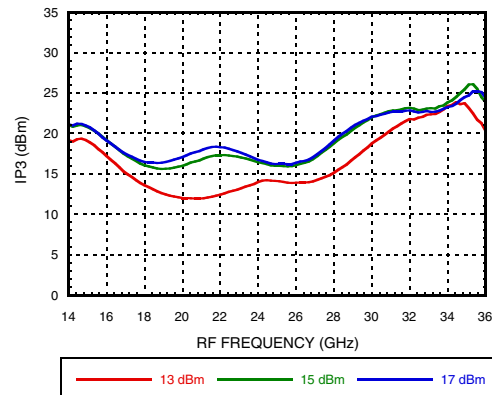

**Input IP3 vs. Temperature  
IF = 12.1 GHz <sup>[1]</sup>**

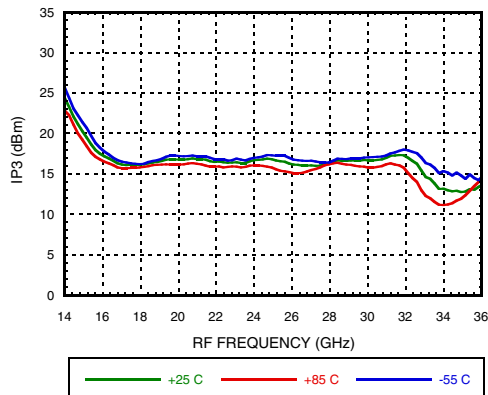

**Input IP3 vs. LO Power  
IF = 12.1 GHz <sup>[1]</sup>**

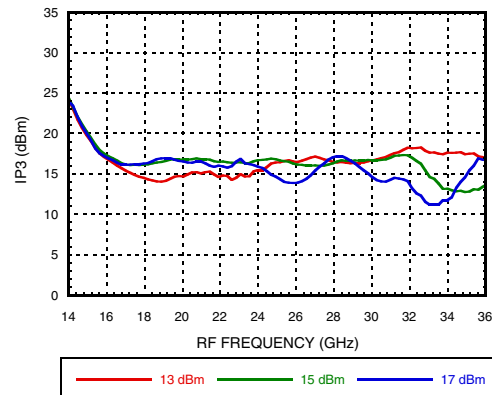

[1] Measurement taken at fixed IF frequency, LSB  
[2] Measurement taken at fixed LO frequency, LSB



**Input IP3 vs. Temperature**  
IF = 16.1 GHz <sup>[1]</sup>

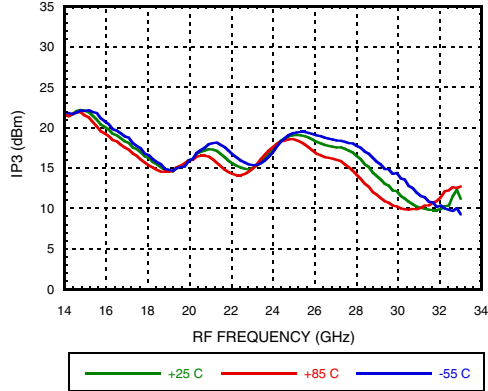

**Input IP3 vs. LO Power**  
IF = 16.1 GHz <sup>[1]</sup>

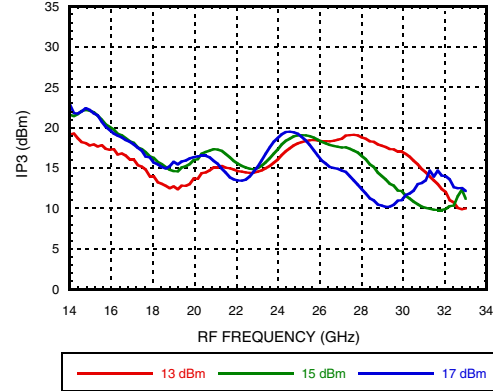

**RF Return Loss vs. Temperature**  
LO = 30GHz

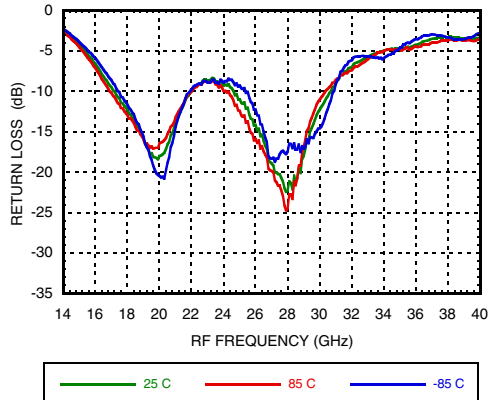

**RF Return Loss vs. LO Power**  
LO = 30GHz

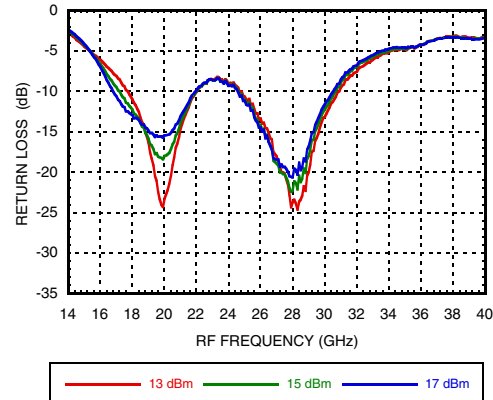

**LO Return Loss vs. Temperature <sup>[2]</sup>**

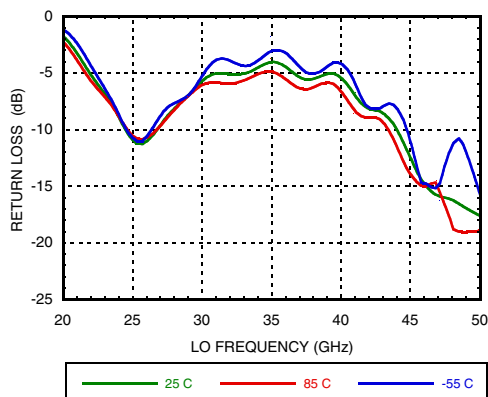

**LO Return Loss vs. LO Power**

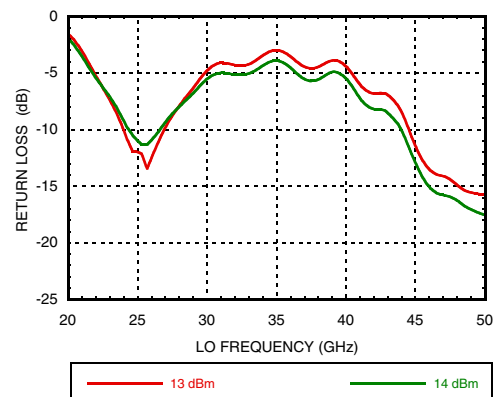

[1] Measurement taken at fixed IF frequency, LSB

[2] Measurement taken at LO power = +14 dBm



**LO/RF Isolation vs. Temperature**

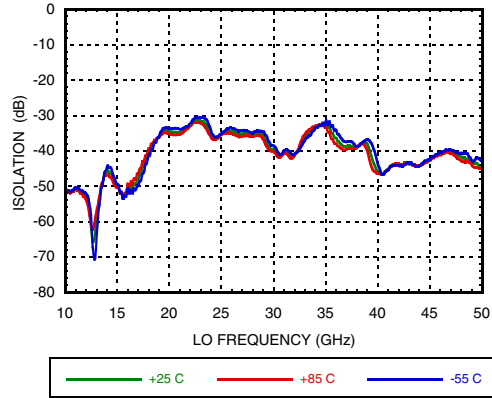

**LO/RF Isolation vs. LO Power**

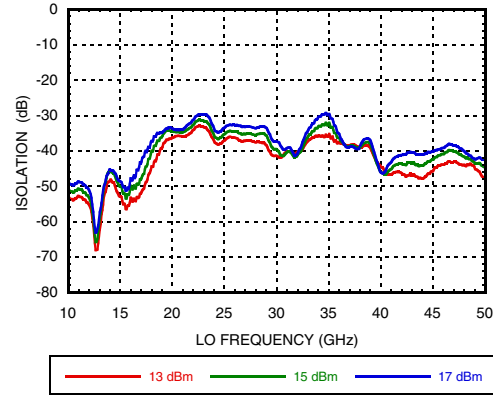

**LO/IF Isolation vs. Temperature**

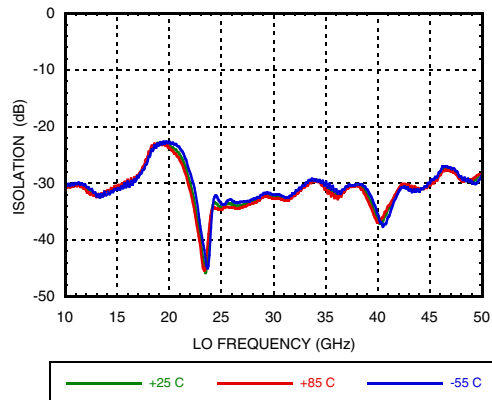

**LO/IF Isolation vs. LO Power**

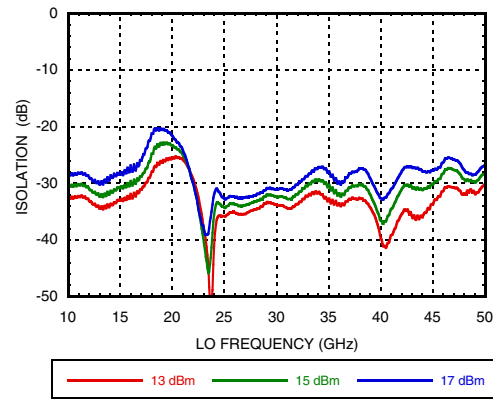

**RF/IF Isolation vs. Temperature  
LO = 20 GHz**

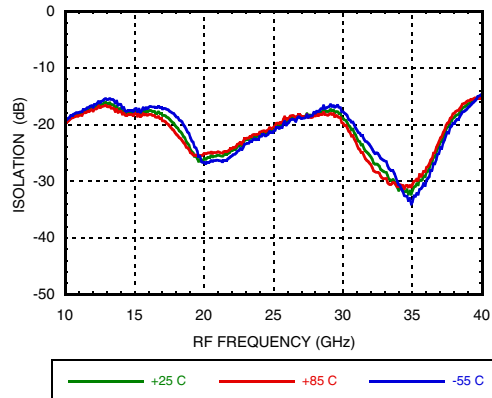

**RF/IF Isolation vs. LO Power  
LO = 20 GHz**

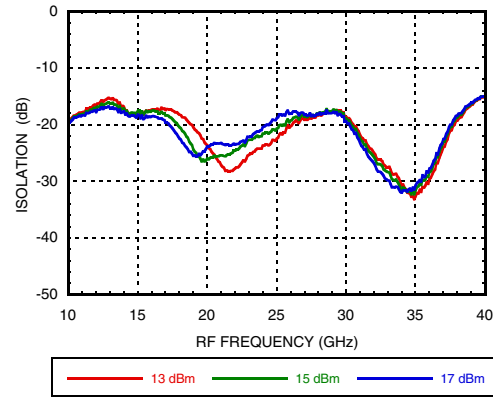



### RF/IF Isolation vs. Temperature LO = 30 GHz

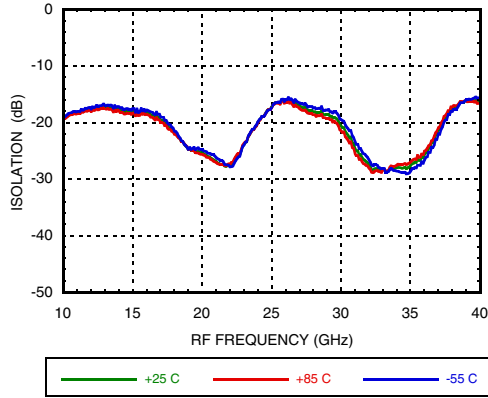

### RF/IF Isolation vs. LO Power LO = 30 GHz

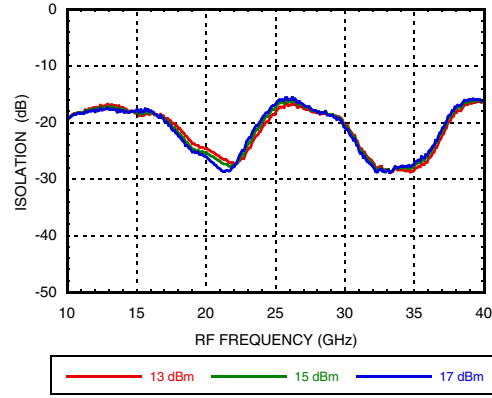

### MxN Spurious Outputs, RF = 20GHz

mRF	nLO				
	0	1	2	3	4
0	xx	1	0	0	0
1	9.8	0	0	0	0
2	58.5	30.3	41.7	0	0
3	0	35	46.6	56	0
4	0	78.5	62.6	57.4	0

RF = 20 GHz @ -4 dBm  
LO = 35 GHz @ +13 dBm  
Data taken without IF hybrid  
All values in dBc below IF power level

### MxN Spurious Outputs, RF = 25 GHz

mRF	nLO				
	0	1	2	3	4
0	xx	0	0	0	0
1	12.5	0	22.5	0	0
2	56.5	25	33.3	0	0
3	0	53.7	55.8	57	0
4	0	0	73.6	64.4	68.8

RF = 25 GHz @ -4 dBm  
LO = 35 GHz @ +13 dBm  
Data taken without IF hybrid  
All values in dBc below IF power level

### MxN Spurious Outputs, RF = 30 GHz

mRF	nLO				
	0	1	2	3	4
0	xx	5	0	0	0
1	16.5	0.2	22.7	0	0
2	0	42.6	57.3	45.5	0
3	0	0	50.5	60.1	0
4	0	0	63.2	68.5	67.3

RF = 30 GHz @ -4 dBm  
LO = 35 GHz @ +13 dBm  
Data taken without IF hybrid  
All values in dBc below IF power level



**Absolute Maximum Ratings**

LO Input Power	+17 dBm
Maximum Junction Temperature	175 °C
Continuous Pdiss (T= 85 °C) (derate 1.75 mW/°C above 85°C)	157 mW
Thermal Resistance (R <sub>TH</sub> ) (junction to die bottom)	570 °C/W
Operating Temperature	-55 to +85 °C
Storage Temperature	-65 to 150 °C
ESD Sensitivity (HBM)	Class1A, passed 250V

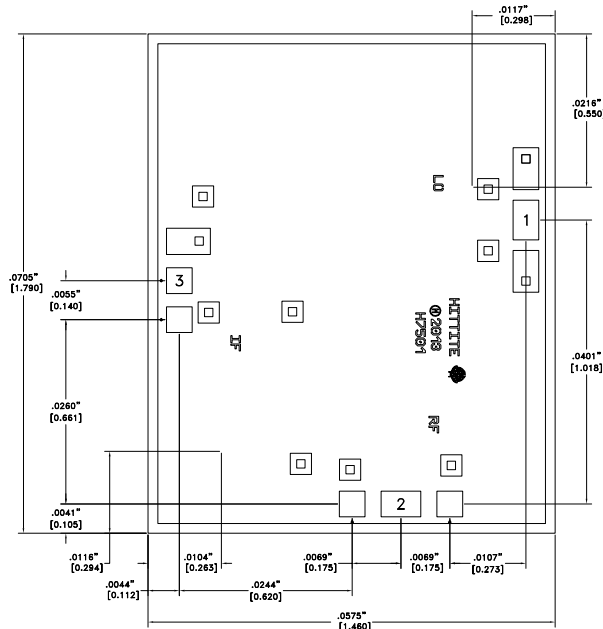
**ELECTROSTATIC SENSITIVE DEVICE  
OBSERVE HANDLING PRECAUTIONS**
**Outline Drawing**

**Die Packaging Information <sup>[1]</sup>**

Standard	Alternate
GP-2 (Gel Pack)	[2]



[1] For more information refer to the "Packaging information" Document in the Product Support Section of our website.

[2] For alternate packaging information contact Hittite Microwave Corporation.

**NOTES:**

1. ALL DIMENSIONS ARE IN INCHES [MM].
2. DIE THICKNESS IS 0.004"
3. BOND PADS 1, 2 & 3 are 0.0059" [0.150] X 0.0039" [0.099].
4. BACKSIDE METALLIZATION: GOLD.
5. BOND PAD METALLIZATION: GOLD.
6. BACKSIDE METAL IS GROUND.
7. CONNECTION NOT REQUIRED FOR UNLABELED BOND PADS.
8. OVERALL DIE SIZE ± 0.002

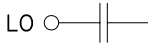
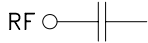
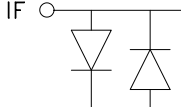
### Pad Descriptions

Pad Number	Function	Description	Pad Schematic
1	LO	This pad is AC coupled and Matched to 50 Ohms.	LO 
2	RF	This pad is AC coupled and Matched to 50 Ohms.	RF 
3	IF	This pad is DC coupled and Matched to 50 Ohms.	IF 
Die Bottom	GND	Die bottom must be connected to RF/DC ground	GND 

### Assembly Diagram

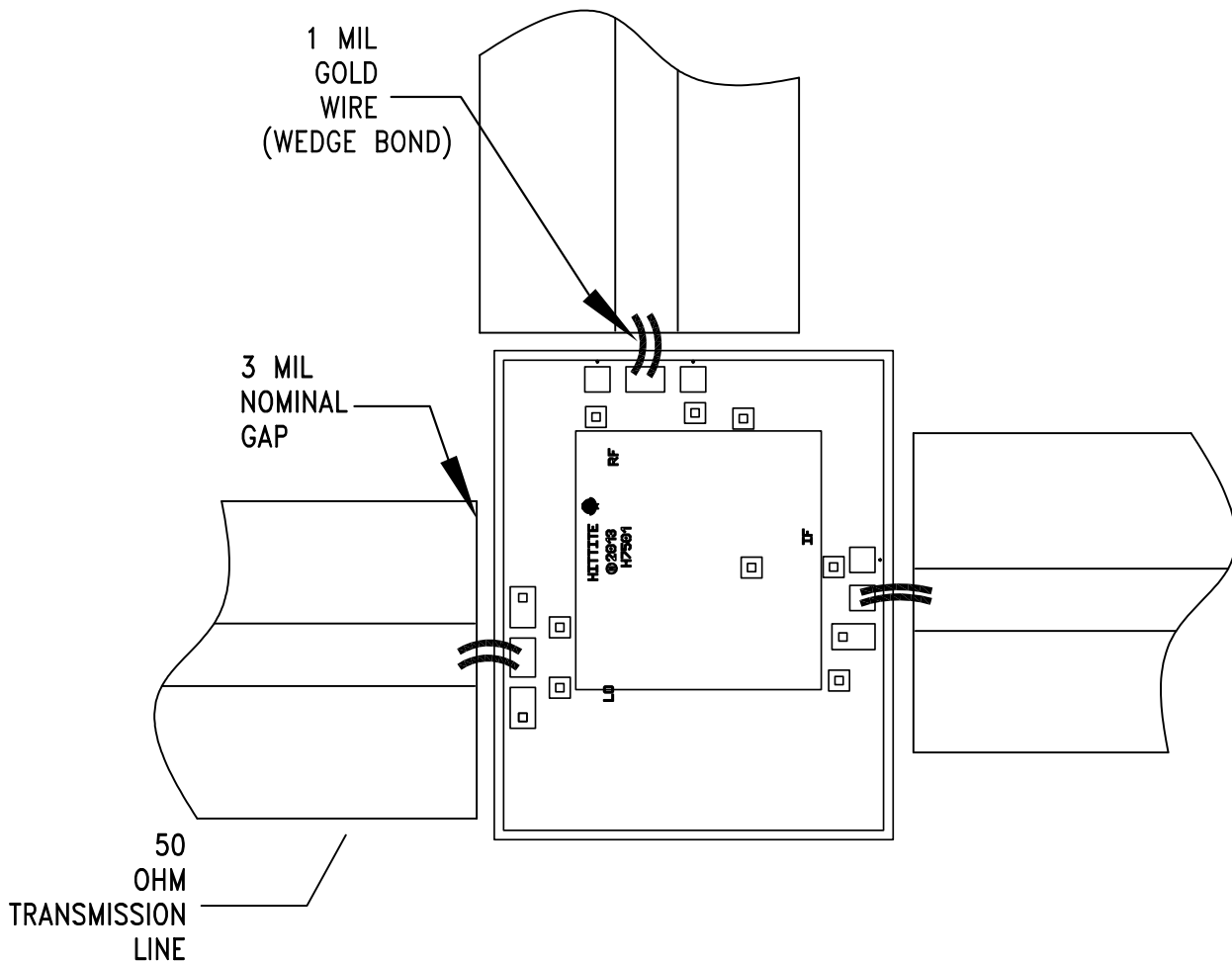



### Mounting & Bonding Techniques for Millimeterwave GaAs MMICs

The die should be attached directly to the ground plane eutectically or with conductive epoxy (see HMC general Handling, Mounting, Bonding Note).

50 Ohm Microstrip transmission lines on 0.127mm (5 mil) thick alumina thin film substrates are recommended for bringing RF to and from the chip (Figure 1). One way to accomplish this is to attach the 0.102mm (4 mil) thick die to a 0.150mm (6 mil) thick molybdenum heat spreader (moly-tab) which is then attached to the ground plane (Figure 2). Microstrip substrates should be located as close to the die as possible in order to minimize bond wire length. Typical die-to-substrate spacing is 0.076mm to 0.152 mm (3 to 6 mils).

#### Handling Precautions

Follow these precautions to avoid permanent damage.

**Storage:** All bare die are placed in either Waffle or Gel based ESD protective containers, and then sealed in an ESD protective bag for shipment. Once the sealed ESD protective bag has been opened, all die should be stored in a dry nitrogen environment.

**Cleanliness:** Handle the chips in a clean environment. DO NOT attempt to clean the chip using liquid cleaning systems.

**Static Sensitivity:** Follow ESD precautions to protect against  $> \pm 250V$  ESD strikes.

**Transients:** Suppress instrument and bias supply transients while bias is applied. Use shielded signal and bias cables to minimize inductive pick-up.

**General Handling:** Handle the chip along the edges with a vacuum collet or with a sharp pair of bent tweezers. The surface of the chip may have fragile air bridges and should not be touched with vacuum collet, tweezers, or fingers.

#### Mounting

The chip is back-metallized and can be die mounted with AuSn eutectic preforms or with electrically conductive epoxy. The mounting surface should be clean and flat.

**Eutectic Die Attach:** A 80/20 gold tin preform is recommended with a work surface temperature of 255 °C and a tool temperature of 265 °C. When hot 90/10 nitrogen/hydrogen gas is applied, tool tip temperature should be 290 °C. DO NOT expose the chip to a temperature greater than 320 °C for more than 20 seconds. No more than 3 seconds of scrubbing should be required for attachment.

**Epoxy Die Attach:** Apply a minimum amount of epoxy to the mounting surface so that a thin epoxy fillet is observed around the perimeter of the chip once it is placed into position. Cure epoxy per the manufacturer's schedule.

#### Wire Bonding

Ball or wedge bond with 0.025mm (1 mil) diameter pure gold wire. Thermosonic wirebonding with a nominal stage temperature of 150 °C and a ball bonding force of 40 to 50 grams or wedge bonding force of 18 to 22 grams is recommended. Use the minimum level of ultrasonic energy to achieve reliable wirebonds. Wirebonds should be started on the chip and terminated on the package or substrate. All bonds should be as short as possible  $< 0.31\text{mm}$  (12 mils).

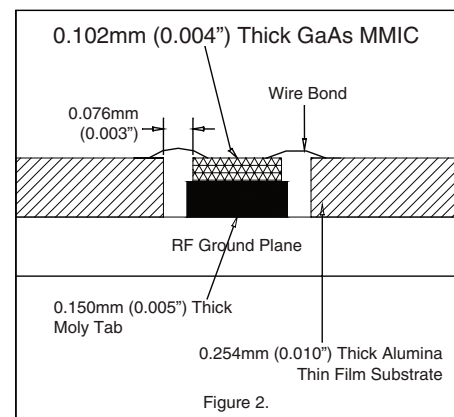
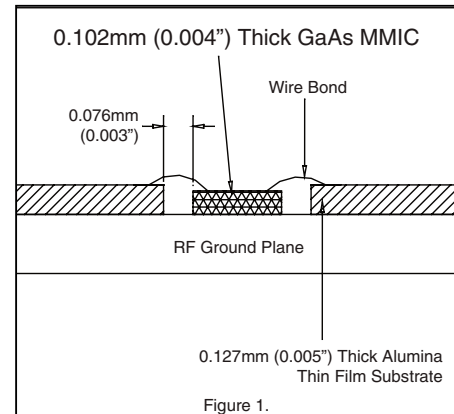



MICROWAVE CORPORATION v01.0314



**HMC1106**

**GaAs MMIC MIXER**  
**15 - 36 GHz**

**Notes:**

Компания «Life Electronics» занимается поставками электронных компонентов импортного и отечественного производства от производителей и со складов крупных дистрибьюторов Европы, Америки и Азии.

С конца 2013 года компания активно расширяет линейку поставок компонентов по направлению коаксиальный кабель, кварцевые генераторы и конденсаторы (керамические, пленочные, электролитические), за счёт заключения дистрибьюторских договоров

Мы предлагаем:

- Конкурентоспособные цены и скидки постоянным клиентам.
- Специальные условия для постоянных клиентов.
- Подбор аналогов.
- Поставку компонентов в любых объемах, удовлетворяющих вашим потребностям.
- Приемлемые сроки поставки, возможна ускоренная поставка.
- Доставку товара в любую точку России и стран СНГ.
- Комплексную поставку.
- Работу по проектам и поставку образцов.
- Формирование склада под заказчика.
- Сертификаты соответствия на поставляемую продукцию (по желанию клиента).
- Тестирование поставляемой продукции.
- Поставку компонентов, требующих военную и космическую приемку.
- Входной контроль качества.
- Наличие сертификата ISO.

В составе нашей компании организован Конструкторский отдел, призванный помогать разработчикам, и инженерам.

Конструкторский отдел помогает осуществить:

- Регистрацию проекта у производителя компонентов.
- Техническую поддержку проекта.
- Защиту от снятия компонента с производства.
- Оценку стоимости проекта по компонентам.
- Изготовление тестовой платы монтаж и пусконаладочные работы.



Тел: +7 (812) 336 43 04 (многоканальный)

Email: [org@lifeelectronics.ru](mailto:org@lifeelectronics.ru)