



Features

- Compact design, long life and high reliability
- Vertical and horizontal mount versions
- Momentary switch
- Dual LED design
- Flatted and knurled shaft styles
- Bushing and bushingless options



PEL12D - 12 mm Encoder with Switch and Illuminated Shaft

Electrical Characteristics

Output.....	2-bit quadrature code
Closed Circuit Resistance	3 ohms maximum
Contact Rating.....	0.5 mA @ 5 VDC
Insulation Resistance	100 megohms @ 250 VDC
Dielectric Withstanding Voltage	
Sea Level.....	300 VAC minimum
Electrical Travel	Continuous
Contact Bounce (15 RPM).....	2.0 ms. maximum**
RPM (Operating)	100 maximum**

Environmental Characteristics

Operating Temperature Range	-10 °C to +70 °C (+14 °F to +158 °F)
Storage Temperature Range	-40 °C to +85 °C (-40 °F to +185 °F)
Operating Humidity.....	25 % to 85 % R.H.
Rotational Life.....	30,000 cycles minimum
Switch Life	20,000 cycles minimum
IP Rating.....	IP 40

Mechanical Characteristics

Mechanical Angle	360 ° continuous
Detent Torque	30 to 200 g-cm (0.42 to 2.77 oz.-in.)
Running Torque	50 g-cm (0.69 oz.-in.) maximum
Shaft Strength (Push).....	5 kgf (11.0 lbs.)
Shaft Strength (Pull)	10 kgf (22.0 lbs.)
Weight	3 gm (0.1 oz.) maximum
Terminals.....	Printed circuit board terminals
Soldering Condition	
Wave Soldering.....	Sn95.5/Ag2.8/Cu0.7 solder with no-clean flux: 260 °C max. for 5 ± 1 seconds
Hand Soldering	Not recommended
Hardware	One flat washer and one mounting nut supplied with each encoder with bushing

Switch Characteristics

Switch Type	Contact Push ON Momentary SPST
Power Rating (Resistive Load)	10 mA at 5 V DC
Contact Resistance	100 milliohms
Switch Travel	0.5 +0.0/-0.3 mm
Switch Actuation Force	450 ± 200 gf (15.9 ± 7.0 oz.)

How To Order

PEL12D - 4 0 21 F - S 1 024

Model _____

Terminal Configuration _____

 2 = Vertical Mount/Side Exit PC Pin 4 = Horizontal Mount/Rear Exit PC Pin

Detent Option _____

 0 = No Detents 2 = 24 Detents

Standard Shaft Length _____

 Flatted: _____ Knurled: _____

 16 = 16.0 mm 26 = 26.0 mm 25 = 25.0 mm

 18 = 18.5 mm 31 = 31.0 mm

 21 = 21.0 mm

Shaft Style _____

 F = Insulated Flatted Shaft S = Insulated Knurled Shaft (18 Teeth)

 G = Insulated Flatted Shaft w/Bushing*** T = Insulated Knurled Shaft (18 Teeth) w/Bushing

Switch Configuration _____

 S = Push Momentary Switch

LED Color _____

 Dual: _____

 1 = Blue/Orange

 2 = Green/Red

 3 = Blue/Green

Resolution _____

 024 = 24 Pulses per 360 ° Rotation

*** Available in 18.5, 21 and 26 mm shaft lengths

*RoHS Directive 2002/95/EC Jan. 27, 2003 including annex and RoHS Recast 2011/65/EU June 8, 2011.

** Devices are tested using standard noise reduction filters. For optimum performance, designers should use noise reduction filters in their circuits.

Specifications are subject to change without notice.

The device characteristics and parameters in this data sheet can and do vary in different applications and actual device performance may vary over time. Users should verify actual device performance in their specific applications.

Applications

Level control, tuning and timer settings in:

- Audio-visual equipment
- Consumer electric appliances
- Musical instrumentation
- Communications equipment

PEL12D - 12 mm Encoder with Switch and Illuminated Shaft BOURNS®

Product Dimensions

PEL12D-4xxxS-Sxxxx (Horizontal Mount w/Dual LED & Switch, Knurled Shaft)

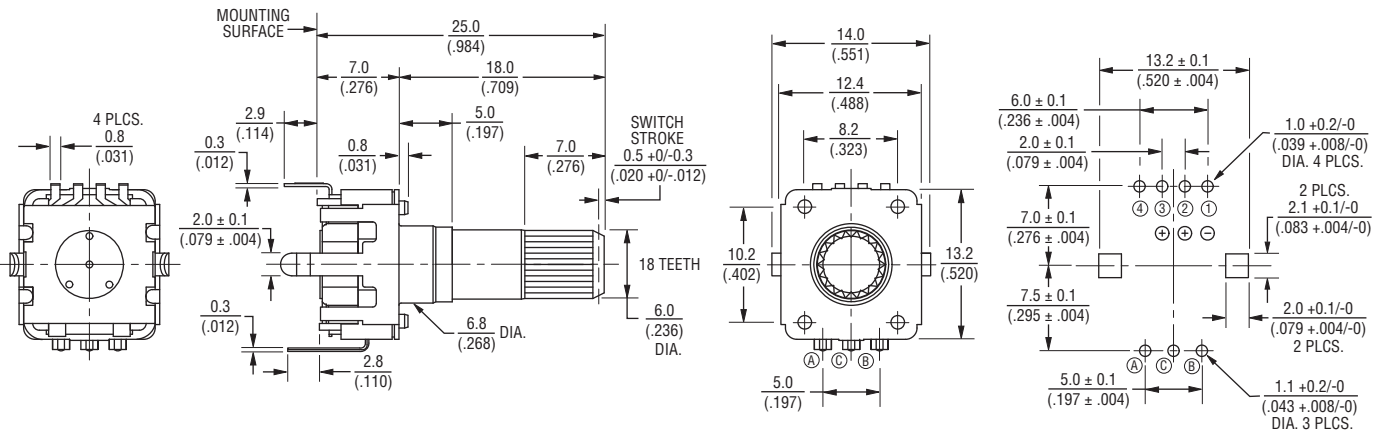

PEL12D-4xxxF-Sxxxx (Horizontal Mount w/Dual LED & Switch, Flatted Shaft)

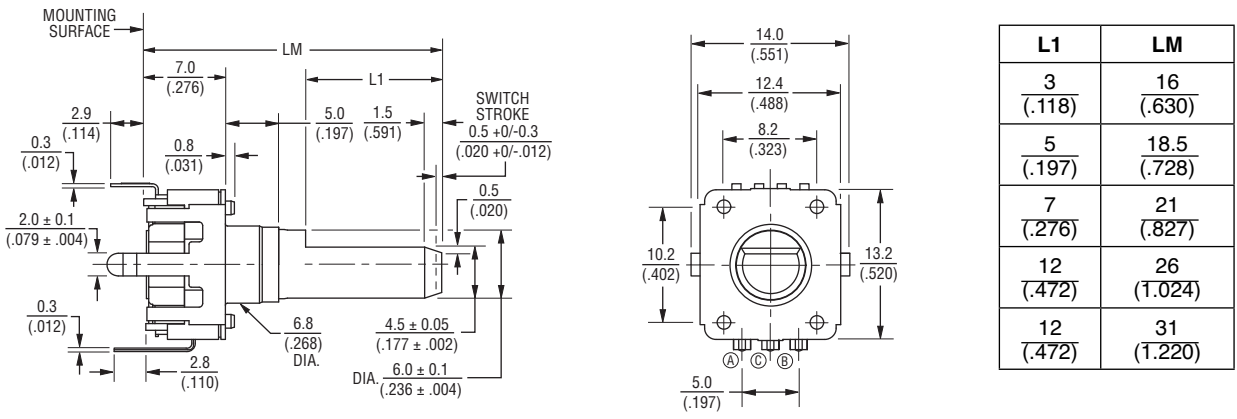

L1	LM
3 (.118)	16 (.630)
5 (.197)	18.5 (.728)
7 (.276)	21 (.827)
12 (.472)	26 (1.024)
12 (.472)	31 (1.220)

DIMENSIONS: $\frac{MM}{(INCHES)}$

Dual LED Circuit

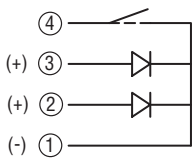

TOLERANCES:
 UNDER $\frac{10.0}{(.394)} = \frac{\pm 0.3}{(\pm .012)}$ $\frac{10.0 - 100}{(.394 - 3.937)} = \frac{\pm 0.5}{(\pm .020)}$

Specifications are subject to change without notice. The device characteristics and parameters in this data sheet can and do vary in different applications and actual device performance may vary over time. Users should verify actual device performance in their specific applications.

PEL12D - 12 mm Encoder with Switch and Illuminated Shaft



Product Dimensions

PEL12D-2xxxS-Sxxxx (Vertical Mount w/Dual LED & Switch, Knurled Shaft)

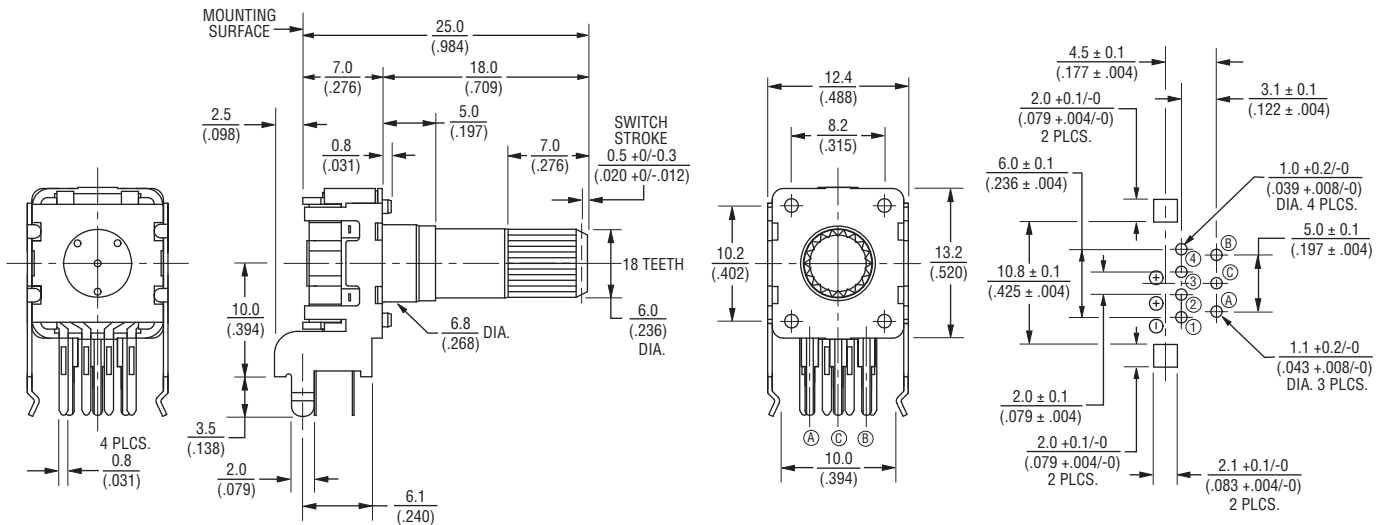

PEL12D-2xxxF-Sxxxx (Vertical Mount w/Dual LED & Switch, Flatted Shaft)

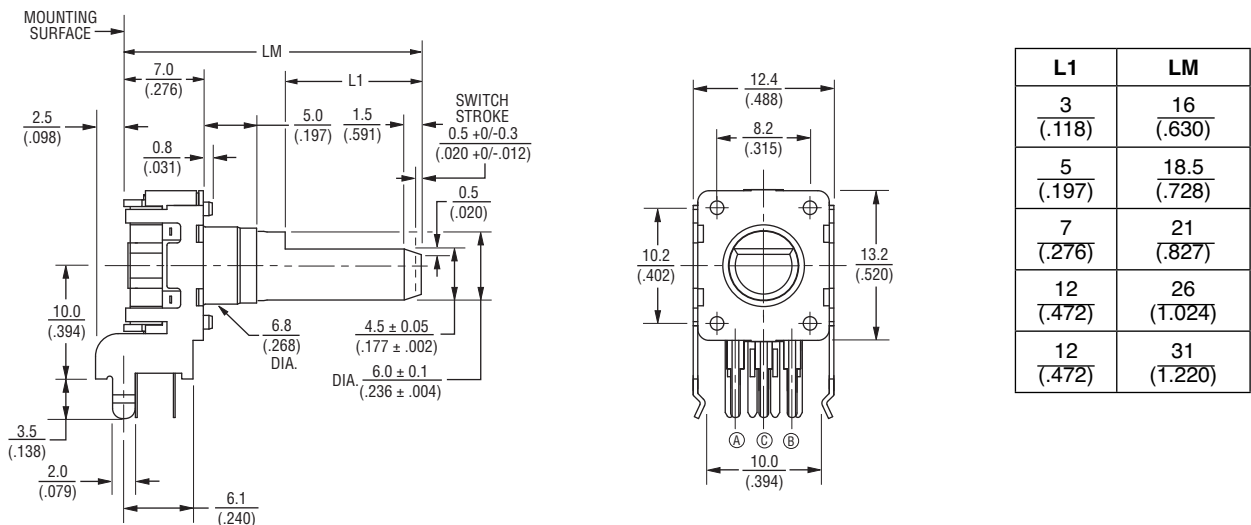

DIMENSIONS: $\frac{\text{MM}}{\text{(INCHES)}}$

TOLERANCES:
 UNDER $\frac{10.0}{(.394)} = \frac{\pm 0.3}{(\pm 0.012)}$ $\frac{10.0 - 100}{(.394 - 3.937)} = \frac{\pm 0.5}{(\pm 0.20)}$

Specifications are subject to change without notice.
 The device characteristics and parameters in this data sheet can and do vary in different applications and actual device performance may vary over time.
 Users should verify actual device performance in their specific applications.

PEL12D - 12 mm Encoder with Switch and Illuminated Shaft



Product Dimensions

PEL12D-4xxxT-Sxxxx (Horizontal Mount w/Dual LED & Switch, Knurled Shaft w/Bushing)

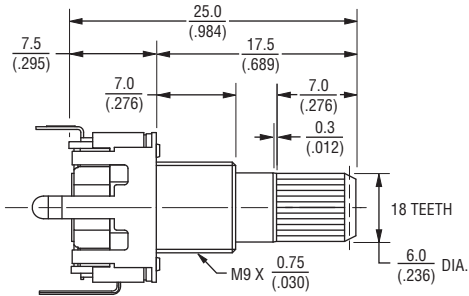

PEL12D-4xxxG-Sxxxx (Horizontal Mount w/Dual LED & Switch, Flatted Shaft w/Bushing)

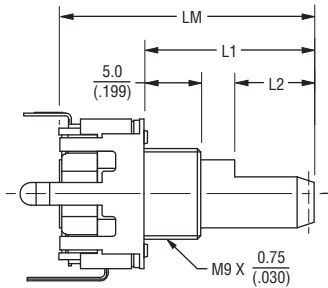

L2	L1	LM
5 (.197)	11 (.433)	18.5 (.728)
7 (.276)	13.5 (.532)	21 (.827)
12 (.472)	18.5 (.728)	26 (1.024)

DIMENSIONS: $\frac{\text{MM}}{\text{(INCHES)}}$

TOLERANCES:
 UNDER $\frac{10.0}{(.394)} = \frac{\pm 0.3}{(\pm 0.012)}$ $\frac{10.0 - 100}{(.394 - 3.937)} = \frac{\pm 0.5}{(\pm 0.020)}$

Quadrature Output Table

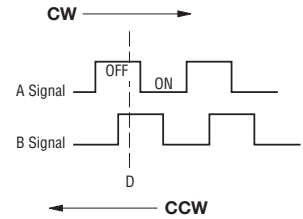

Suggested Filter Circuit

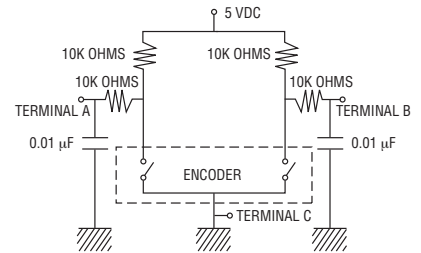

LED Terminal Decoder

Code	Color	Terminals
1	Blue / Orange	① ② / ① ③
2	Green / Red	① ② / ① ③
3	Blue / Green	① ② / ① ③

LED Characteristics (Dual)

LED Color		Power Dissipation (mW)	DC Forward Current (mA)	Forward Voltage (V)	
				Typ.	Max.
Blue/ Orange	Blue	105	30	3.3	4.0
	Orange	75	30	2.1	2.5
Green/ Red	Green	120	30	3.2	4.0
	Red	75	30	1.95	2.5
Blue/ Green	Blue	120	30	3.3	4.0
	Green	120	30	3.2	4.0
Red/ Green	Red	75	30	1.95	2.5
	Green	120	30	3.2	4.0

Notes:

Reverse Current: 10 μ A
 Reverse Voltage: 5 VDC
 Test Condition (IF): 20 mA

The device characteristics and parameters in this data sheet can and do vary in different applications and actual device performance may vary over time. Users should verify actual device performance in their specific applications.



Asia-Pacific:
 Tel: +886-2 2562-4117
 Fax: +886-2 2562-4116

EMEA:
 Tel: +36 88 520 390
 Fax: +36 88 520 211

The Americas:
 Tel: +1-951 781-5500
 Fax: +1-951 781-5700

www.bourns.com

Компания «Life Electronics» занимается поставками электронных компонентов импортного и отечественного производства от производителей и со складов крупных дистрибьюторов Европы, Америки и Азии.

С конца 2013 года компания активно расширяет линейку поставок компонентов по направлению коаксиальный кабель, кварцевые генераторы и конденсаторы (керамические, пленочные, электролитические), за счёт заключения дистрибьюторских договоров

Мы предлагаем:

- Конкурентоспособные цены и скидки постоянным клиентам.
- Специальные условия для постоянных клиентов.
- Подбор аналогов.
- Поставку компонентов в любых объемах, удовлетворяющих вашим потребностям.
- Приемлемые сроки поставки, возможна ускоренная поставка.
- Доставку товара в любую точку России и стран СНГ.
- Комплексную поставку.
- Работу по проектам и поставку образцов.
- Формирование склада под заказчика.
- Сертификаты соответствия на поставляемую продукцию (по желанию клиента).
- Тестирование поставляемой продукции.
- Поставку компонентов, требующих военную и космическую приемку.
- Входной контроль качества.
- Наличие сертификата ISO.

В составе нашей компании организован Конструкторский отдел, призванный помогать разработчикам, и инженерам.

Конструкторский отдел помогает осуществить:

- Регистрацию проекта у производителя компонентов.
- Техническую поддержку проекта.
- Защиту от снятия компонента с производства.
- Оценку стоимости проекта по компонентам.
- Изготовление тестовой платы монтаж и пусконаладочные работы.



Тел: +7 (812) 336 43 04 (многоканальный)

Email: org@lifeelectronics.ru