

MECHANICAL DATA

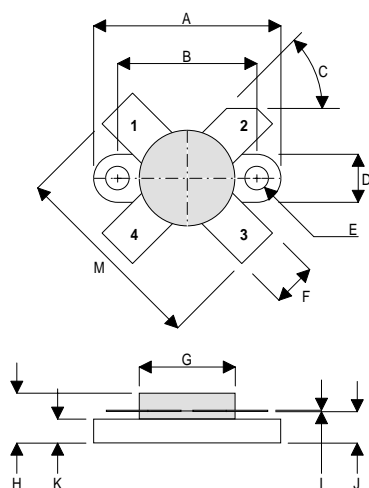

DM

PIN 1 SOURCE                      PIN 2 DRAIN  
 PIN 3 SOURCE                      PIN 4 GATE

DIM	mm	Tol.	Inches	Tol.
A	24.76	0.13	0.975	0.005
B	18.42	0.13	0.725	0.005
C	45°	5°	45°	5°
D	6.35	0.13	0.25	0.005
E	3.17 Dia.	0.13	0.125 Dia.	0.005
F	5.71	0.13	0.225	0.005
G	12.7 Dia.	0.13	0.500 Dia.	0.005
H	6.60	REF	0.260	REF
I	0.13	0.02	0.005	0.001
J	4.32	0.13	0.170	0.005
K	3.17	0.13	0.125	0.005
M	26.16	0.25	1.03	0.010

**GOLD METALLISED  
 MULTI-PURPOSE SILICON  
 DMOS RF FET  
 150W – 28V – 175MHz  
 SINGLE ENDED**

**FEATURES**

- SIMPLIFIED AMPLIFIER DESIGN
- SUITABLE FOR BROAD BAND APPLICATIONS
- LOW  $C_{rss}$
- SIMPLE BIAS CIRCUITS
- LOW NOISE
- HIGH GAIN – 13 dB MINIMUM

**APPLICATIONS**

- HF/VHF/UHF COMMUNICATIONS  
 from 1 MHz to 200 MHz

**ABSOLUTE MAXIMUM RATINGS** ( $T_{case} = 25^{\circ}C$  unless otherwise stated)

$P_D$	Power Dissipation	220W
$BV_{DSS}$	Drain – Source Breakdown Voltage	70V
$BV_{GSS}$	Gate – Source Breakdown Voltage	$\pm 20V$
$I_{D(sat)}$	Drain Current	30A
$T_{stg}$	Storage Temperature	-65 to 150°C
$T_j$	Maximum Operating Junction Temperature	200°C

Semelab Plc reserves the right to change test conditions, parameter limits and package dimensions without notice. Information furnished by Semelab is believed to be both accurate and reliable at the time of going to press. However Semelab assumes no responsibility for any errors or omissions discovered in its use. Semelab encourages customers to verify that datasheets are current before placing orders.

## ELECTRICAL CHARACTERISTICS (T<sub>case</sub> = 25°C unless otherwise stated)

Parameter	Test Conditions	Min.	Typ.	Max.	Unit
B <sub>V</sub> DSS Drain–Source Breakdown Voltage	V <sub>GS</sub> = 0      I <sub>D</sub> = 100mA	70			V
I <sub>DSS</sub> Zero Gate Voltage Drain Current	V <sub>DS</sub> = 28V      V <sub>GS</sub> = 0			6	mA
I <sub>GSS</sub> Gate Leakage Current	V <sub>GS</sub> = 20V      V <sub>DS</sub> = 0			1	μA
V <sub>GS(th)</sub> Gate Threshold Voltage*	I <sub>D</sub> = 10mA      V <sub>DS</sub> = V <sub>GS</sub>	1		7	V
g <sub>fs</sub> Forward Transconductance*	V <sub>DS</sub> = 10V      I <sub>D</sub> = 6A	4.8			S
G <sub>PS</sub> Common Source Power Gain	P <sub>O</sub> = 150W	13			dB
η Drain Efficiency	V <sub>DS</sub> = 28V      I <sub>DQ</sub> = 0.6A	50			%
VSWR Load Mismatch Tolerance	f = 175MHz	20:1			—
C <sub>iss</sub> Input Capacitance	V <sub>DS</sub> = 0V      V <sub>GS</sub> = -5V      f = 1MHz			360	pF
C <sub>oss</sub> Output Capacitance	V <sub>DS</sub> = 28V      V <sub>GS</sub> = 0      f = 1MHz			180	pF
C <sub>rss</sub> Reverse Transfer Capacitance	V <sub>DS</sub> = 28V      V <sub>GS</sub> = 0      f = 1MHz			15	pF

\* Pulse Test: Pulse Duration = 300 μs , Duty Cycle ≤ 2%

## HAZARDOUS MATERIAL WARNING

The ceramic portion of the device between leads and metal flange is beryllium oxide. Beryllium oxide dust is highly toxic and care must be taken during handling and mounting to avoid damage to this area.

**THESE DEVICES MUST NEVER BE THROWN AWAY WITH GENERAL INDUSTRIAL OR DOMESTIC WASTE.**

## THERMAL DATA

R <sub>THj-case</sub>	Thermal Resistance Junction – Case	Max. 0.8°C / W
-----------------------	------------------------------------	----------------

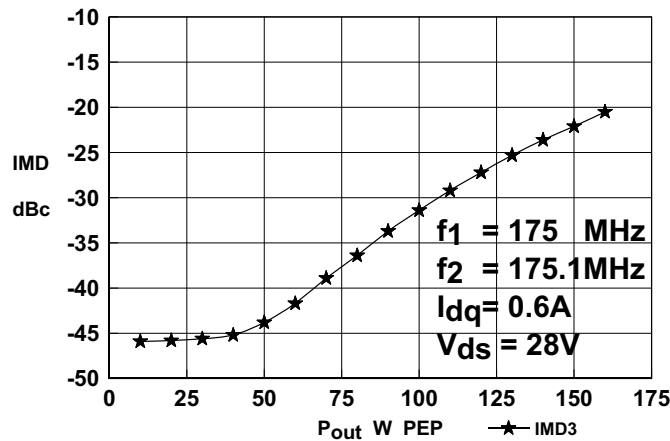
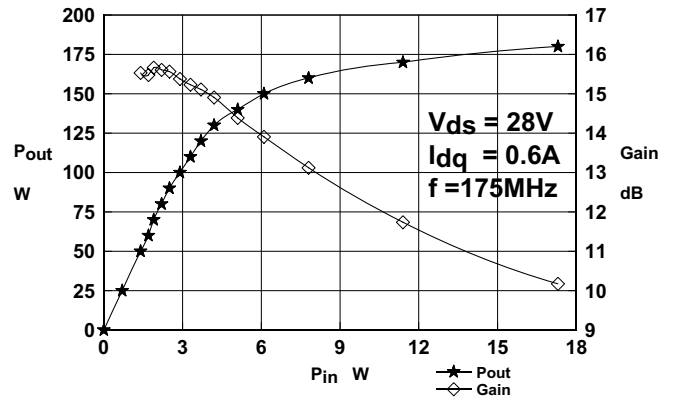
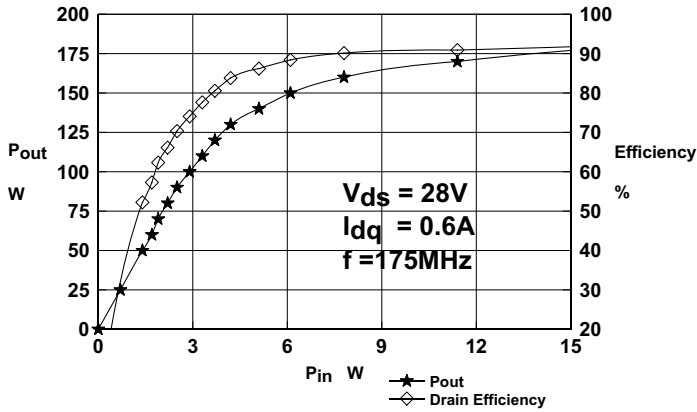

**Figure 3**  
IMD Versus Power Output  
**Typical S Parameters**

!  $V_{ds}=28V$   
# MHz S MA R 50

$I_{dq}=0.6A$

!Freq !MHz	S11		S21		S12		S22	
	mag	ang	mag	ang	mag	ang	mag	ang
50	0.83	-167.4	7.42	93.3	0.009	26.5	0.79	-167
100	0.89	-169.4	3.56	64.1	0.008	44.1	0.82	-163.7
150	0.93	-169.3	2.05	45.2	0.01	75.4	0.87	-164.7
200	0.95	-170.1	1.23	34.2	0.016	88.2	0.91	-166.3
250	0.96	-170.2	0.85	26	0.023	89.1	0.94	-167.7
300	0.97	-169.7	0.62	22.6	0.03	90.1	0.96	-169
350	0.97	-170.4	0.44	15.2	0.035	86.1	0.96	-169.8
400	0.98	-169.3	0.35	17.8	0.043	85.2	0.97	-170.5
450	0.98	-169	0.27	15.9	0.046	84	0.98	-171.7
500	0.99	-168.5	0.23	19.6	0.053	83.1	0.99	-171.4

Semelab Plc reserves the right to change test conditions, parameter limits and package dimensions without notice. Information furnished by Semelab is believed to be both accurate and reliable at the time of going to press. However Semelab assumes no responsibility for any errors or omissions discovered in its use. Semelab encourages customers to verify that datasheets are current before placing orders.

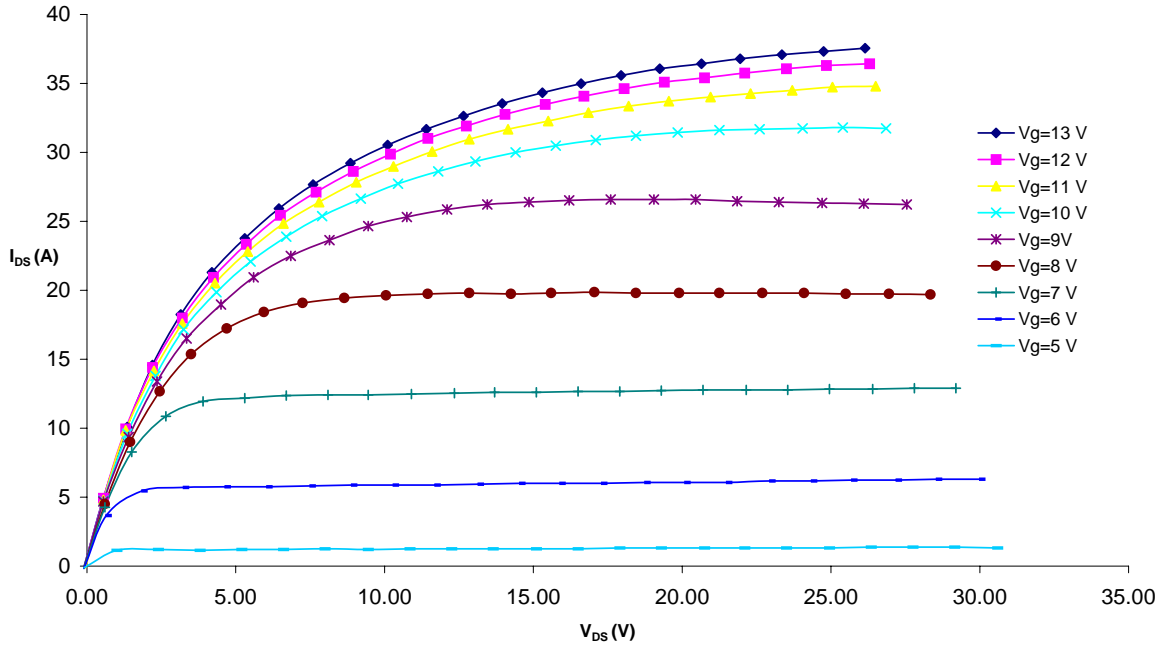

Figure 4 – Typical IV Characteristics.

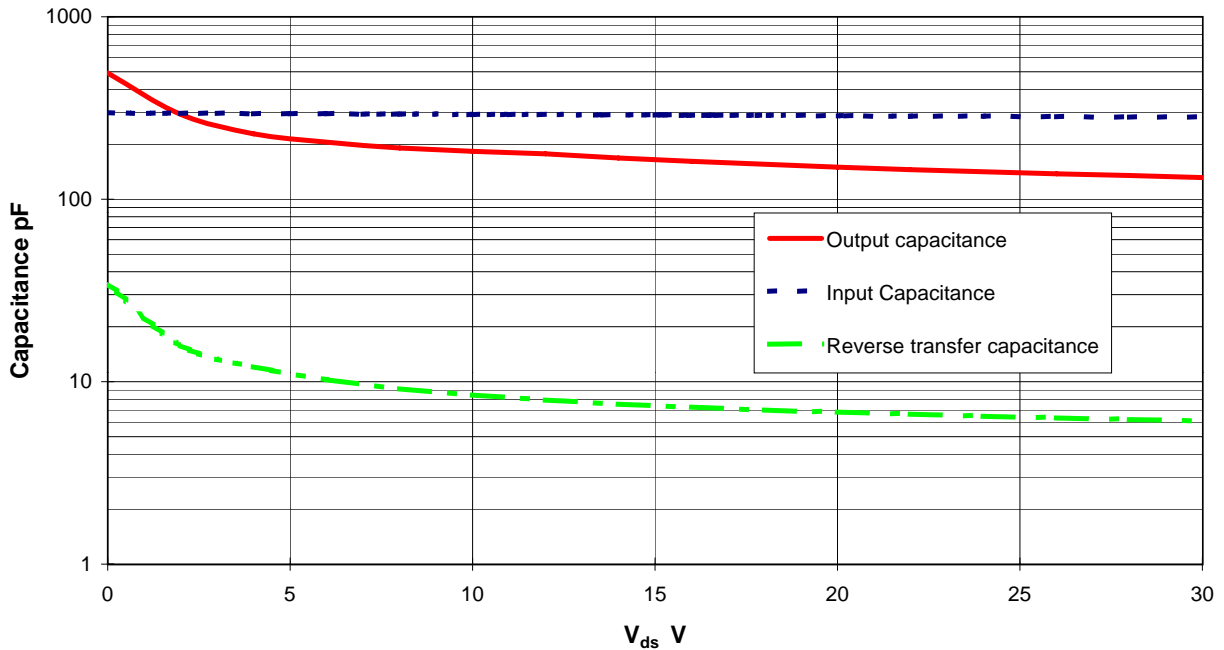
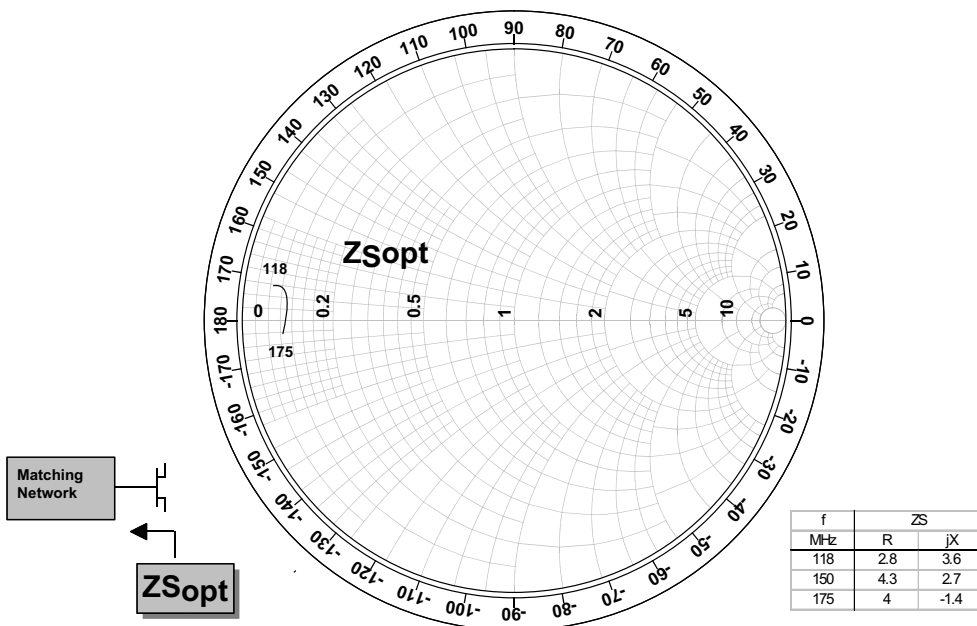
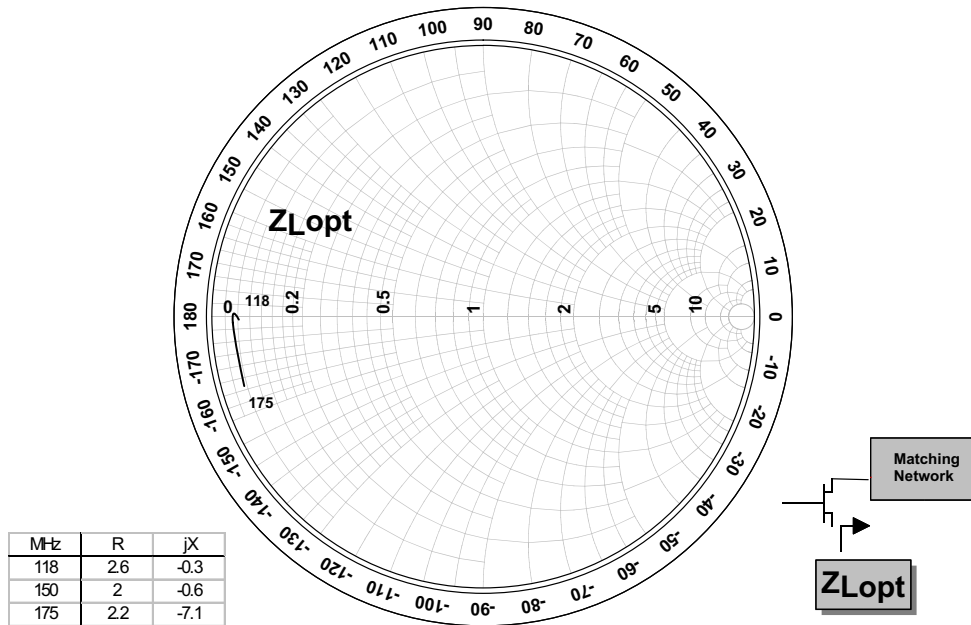
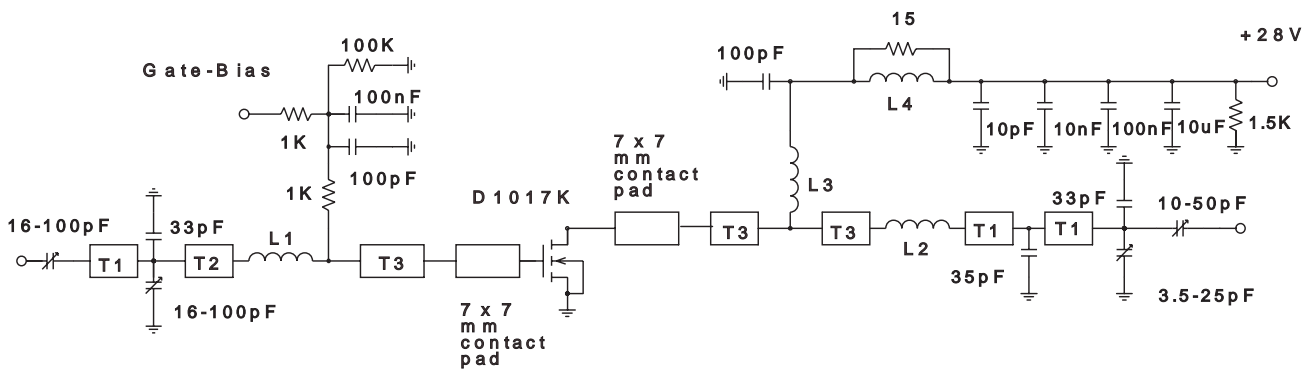

Figure 5 – Typical CV Characteristics.

Semelab Plc reserves the right to change test conditions, parameter limits and package dimensions without notice. Information furnished by Semelab is believed to be both accurate and reliable at the time of going to press. However Semelab assumes no responsibility for any errors or omissions discovered in its use. Semelab encourages customers to verify that datasheets are current before placing orders.



Semelab Plc reserves the right to change test conditions, parameter limits and package dimensions without notice. Information furnished by Semelab is believed to be both accurate and reliable at the time of going to press. However Semelab assumes no responsibility for any errors or omissions discovered in its use. Semelab encourages customers to verify that datasheets are current before placing orders.



### 175MHz TEST FIXTURE

Substrate 1.6mm PTFE/glass, Er=2.5

All microstrip lines W = 5mm

T1,T2        7.5mm

T3            6mm

L1            Hairpin loop 18swg 10mm high, 6.5mm gap

L2            Hairpin loop 5mm wide ribbon, 7mm high, 3.5mm gap

L3            9 turns 19swg enamelled copper wire, 6mm i.d.

L4            12 turns 19swg enamelled copper wire on Fair-Rite FT82 ferrite core

# Mouser Electronics

Authorized Distributor

Click to View Pricing, Inventory, Delivery & Lifecycle Information:

[TT Electronics:](#)

[D1017UK](#)

Компания «Life Electronics» занимается поставками электронных компонентов импортного и отечественного производства от производителей и со складов крупных дистрибьюторов Европы, Америки и Азии.

С конца 2013 года компания активно расширяет линейку поставок компонентов по направлению коаксиальный кабель, кварцевые генераторы и конденсаторы (керамические, пленочные, электролитические), за счёт заключения дистрибьюторских договоров

Мы предлагаем:

- Конкурентоспособные цены и скидки постоянным клиентам.
- Специальные условия для постоянных клиентов.
- Подбор аналогов.
- Поставку компонентов в любых объемах, удовлетворяющих вашим потребностям.
- Приемлемые сроки поставки, возможна ускоренная поставка.
- Доставку товара в любую точку России и стран СНГ.
- Комплексную поставку.
- Работу по проектам и поставку образцов.
- Формирование склада под заказчика.
- Сертификаты соответствия на поставляемую продукцию (по желанию клиента).
- Тестирование поставляемой продукции.
- Поставку компонентов, требующих военную и космическую приемку.
- Входной контроль качества.
- Наличие сертификата ISO.

В составе нашей компании организован Конструкторский отдел, призванный помогать разработчикам, и инженерам.

Конструкторский отдел помогает осуществить:

- Регистрацию проекта у производителя компонентов.
- Техническую поддержку проекта.
- Защиту от снятия компонента с производства.
- Оценку стоимости проекта по компонентам.
- Изготовление тестовой платы монтаж и пусконаладочные работы.



Тел: +7 (812) 336 43 04 (многоканальный)

Email: [org@lifeelectronics.ru](mailto:org@lifeelectronics.ru)