



A. HE89A21 Introduction

HE8A21 is a member of 8-bit Micro-controller series used for telephone communication developed by King Billion Electronics Ltd. Users can chose any one of combination among 【128 dots LCD Driver + 16 Bit I/O Port】... 【64 dots LCD Driver + 32 Bit I/O Port】etc. This Also built-in a DTMF generator can generate the PSTN dialing tone directly. It can be applicable as Small/ Medium class telephone communication product etc..

The instruction set of HE89A21 are quite easy to learn and simple to use. Only about thirty instructions with four-type addressing mode are provided. Most of instructions take only 3 oscillator clocks (machine cycles). The processing power is enough to most of battery operation system.

B. HE89A21 Features

- Operation Voltage : 2.4V – 5.5V
- System Clock : DC ~ 8MHz @ 5.0V
- DC ~ 4MHz @ 2.4V
- Internal ROM : 16K Bytes(16K Program ROM)
- Internal RAM : 512 Bytes.
- Dual Clock System : Normal (Fast) clock : 32.768K ~ 8MHz
- Slow clock : 32.768KHz
- Operation Mode : DUAL、FAST、SLOW、IDLE、SLEEP Mode.
- With WDT (WATCH DOG TIMER) to prevent deadlock condition..
- 16~32 bit Bi-directional I/O port. Mask Option can select PUSH-PULL or OPEN DRAIN output mode for each I/O pin.
- 128~64 dots LCD driver (A, B TYPE selectable).
- Built-in DTMF Generator.
- Two external interrupts and three internal timer interrupts.
- Two 16-bit timer and one Time Base timer.
- Instruction set : 32 instructions, 4 addressing mode. 9-bit DATA POINTER for RAM and 14-bit TABLE POINTER for ROM.

C. Internal Block

Please always take in mind that ICE is different from IC. ICE is the whole set of HE80000 series IC, but each IC is a subset of ICE. Never use any hardware resource that real IC didn't have, especially RAM and register. KBIDS and compiler cannot prevent user to use some hardware resource that didn't exist. Please check the following table and refer the abbreviation in HE80000 user's manual.

E.S.C.	I.P.R	PROM	DROM	TP	TP+1	RAM	PP	DP	I/O	DTMF	WDT	Timer	
⊙	⊙	16KB	—	14-bit	⊙	512B	1-bit	8-bit	16~32	⊙	⊙	T1,T2,TB	
VO	DAO	OP	PWM	LCD	COM*SEG	Bias	Rgr	ChrgPmp	LV2	LR	LVG	REC	S.R.
—	—	—	—	128~64	4*32	1/3	—	1	⊙	—	—	—	—



D. Pin Description

Pin #	Pin name	I/O	Function	Description
50 49	FXI, FXO	B, O	External fast clock pin. Connecting to crystal or RC to generate 32.768 kHz ~ 8MHz frequency.	Mask option setting : MO_FCK/SCKN= 00 : Slow Clock only 01 : Illegal 10 : Dual Clock 11 : Fast Clock only
53 52	SXI, SXO	I, O	External slow clock pin. Connecting with 32768 Hz crystal or resistor as slow clock and providing clock source for LCD display, TIMER1, Time-Base and other internal blocks.	MO_FOSCE = 0 : Internal fast osc. = 1 : External fast osc. MO_FXTAL = 0 : RC osc. for fast clock = 1 : X'tal osc. for fast clock MO_SXTAL = 0 : RC for 32768 Hz clock = 1 : X'tal for 32768 Hz clock Use OP1 and OP2 to switch among different operation mode (NORMAL, SLOW, IDEL and SLEEP). In Dual Clock mode, the main system clock is still the Fast Clock. The 32768 Hz clock is for LCD and Timer 1 only.
48	RSTP_N	I	System Reset.	Level trigger, active low. Except for using this pin, using mask option (MO_PORE=1) could enable IC build-in Power-on reset circuit. Besides, MO_WDTE can set Watch Dog Timer : MO_WDTE=0 : Disable Watch Dog Timer =1 : Enable Watch Dog Timer
51	TSTP_P	I	Test Pin	Please bond this pin and add a test point on PCB for debugging. Leave this pin floating is OK.
67,68 1..6	PRTC[7:0]	B	8-pin bi-directional I/O port.	Mask options : MO_CPP[7..0]=1 ~ Push-pull. =0 ~ Open-drain. Output must be "1" before reading whenever use them as input (No tri-state structure).
59..66	PRTD[7:0]	B	8-pin bi-directional I/O port. PRTD[7..2] as wake-up pin. PRTD[7..6] as external interrupt pin.	Mask options : MO_DPP[7..0]=1 ~ Push-pull. =0 ~ Open-drain. Output must be "1" before reading whenever use them as input (No tri-state structure).
15.. 22	PRT14[7:0]/ SEG[23:16]	B/ O	8-pin bi-directional I/O port that is shared with LCD segment pin.	Mask options : MO_LIO14[7..0]=1 ~ LCD Pin. =0 ~ I/O Pin. MO_14PP[7..0]=1 ~ Push-pull. =0 ~ Open-drain. Output must be "1" before reading whenever use them as input (No tri-state structure).
7..14	PRT15[7:0]/ SEG[31:24]	B/ O	8-pin bi-directional I/O port that is shared with LCD segment pin.	Mask options : MO_LIO15[7..0]=1 ~ LCD Pin. =0 ~ I/O Pin. MO_15PP[7..0]=1 ~ Push-pull. =0 ~ Open-drain. Output must be "1" before reading whenever use them as input (No tri-state structure).
39..42	COM[3:0]	O	LCD COMmon Output	



Pin #	Pin name	I/O	Function	Description
23..38	SEG[15:0]	O	LCD SEGment Output	LCD Data filled from F0H, please refer the LCD RAM map.
44	LC2	B	Charge Pump Switch 1	Add one 0.1 μ F capacitor between LC1 and LC2. Please refer the application circuit.
43	LC1	B	Charge Pump Switch 2	
46	LV2	B	Charge Pump V2	Please refer the application circuit.
45	LV1	B	Charge Pump V1	
56	DTMFO	O	DTMF Output	Through PRT12 we can turn on/off DTMF and write data. Using Mask Option MO_DTMFSCK set the clock source of DTMF block. MO_DTMFSCK=0 ; Clock Source=3.579545 MHz =1 ; Clock Source=32768 Hz
55	MUTE	O	MUTE Output for Dialer	User can turn on/off MUTE pin by port12.
57	SDO	O	Serial Data Output	We can turn on/off SDO block or write data by port12.
58	KEYTONE	O	1024-Hz 50% duty square wave	User can turn on/off key tone by port12.
54	VDD	P	Positive Power Input	Adding 0.1 μ F capacitor as by-pass capacitor is between VDD and GND is necessary.
47	GND	P	Power Ground Input	

E. LCD RAM 的配置

Page 0:

F0H	SEG1	SEG0	F8H	SEG17	SEG16
	COM[3:0]	COM[3:0]		COM[3:0]	COM[3:0]
F1H	SEG3	SEG2	F9H	SEG19	SEG18
	COM[3:0]	COM[3:0]		COM[3:0]	COM[3:0]
F2H	SEG5	SEG4	FAH	SEG21	SEG20
	COM[3:0]	COM[3:0]		COM[3:0]	COM[3:0]
F3H	SEG7	SEG6	FBH	SEG23	SEG22
	COM[3:0]	COM[3:0]		COM[3:0]	COM[3:0]
F4H	SEG9	SEG8	FCH	SEG25	SEG24
	COM[3:0]	COM[3:0]		COM[3:0]	COM[3:0]
F5H	SEG11	SEG10	FDH	SEG27	SEG26
	COM[3:0]	COM[3:0]		COM[3:0]	COM[3:0]
F6H	SEG13	SEG12	FEH	SEG29	SEG28
	COM[3:0]	COM[3:0]		COM[3:0]	COM[3:0]
F7H	SEG15	SEG14	FFH	SEG31	SEG30
	COM[3:0]	COM[3:0]		COM[3:0]	COM[3:0]



F. Pin Diagram

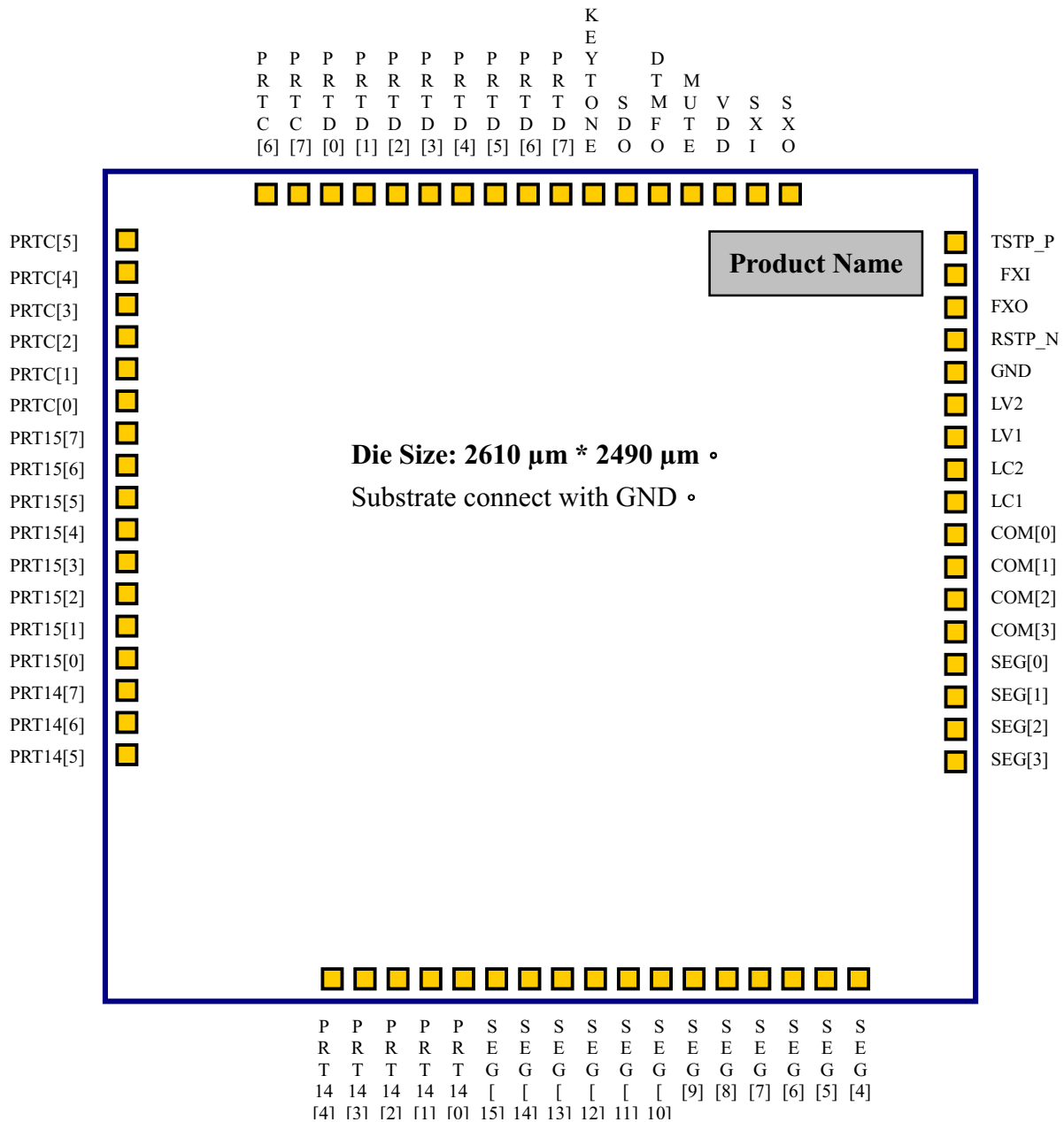



G. Bonding Pad Location

PIN Number	PIN Name	X Coordinate	Y Coordinate	PIN Number	PIN Name	X Coordinate	Y Coordinate
1	PRTC[5]	X= -1218.70	Y= 1016.20	35	SEG[3]	X= 1218.30	Y= -867.80
2	PRTC[4]	X= -1218.70	Y= 900.80	36	SEG[2]	X= 1218.30	Y= -752.20
3	PRTC[3]	X= -1218.70	Y= 785.20	37	SEG[1]	X= 1218.30	Y= -636.80
4	PRTC[2]	X= -1218.70	Y= 669.80	38	SEG[0]	X= 1218.30	Y= -521.20
5	PRTC[1]	X= -1218.70	Y= 554.20	39	COM[3]	X= 1218.30	Y= -405.80
6	PRTC[0]	X= -1218.70	Y= 438.80	40	COM[2]	X= 1218.30	Y= -290.20
7	PRT15[7]	X= -1218.70	Y= 323.20	41	COM[1]	X= 1218.30	Y= -174.80
8	PRT15[6]	X= -1218.70	Y= 207.80	42	COM[0]	X= 1218.30	Y= -59.20
9	PRT15[5]	X= -1218.70	Y= 92.20	43	LC1	X= 1218.30	Y= 56.20
10	PRT15[4]	X= -1218.70	Y= -23.20	44	LC2	X= 1218.30	Y= 171.80
11	PRT15[3]	X= -1218.70	Y= -138.80	45	LV1	X= 1218.30	Y= 287.20
12	PRT15[2]	X= -1218.70	Y= -254.20	46	LV2	X= 1218.30	Y= 402.80
13	PRT15[1]	X= -1218.70	Y= -369.80	47	GND	X= 1218.30	Y= 518.20
14	PRT15[0]	X= -1218.70	Y= -485.20	48	RSTP_N	X= 1218.30	Y= 633.80
15	PRT14[7]	X= -1218.70	Y= -600.80	49	FXO	X= 1218.30	Y= 749.20
16	PRT14[6]	X= -1218.70	Y= -716.20	50	FXI	X= 1218.30	Y= 864.80
17	PRT14[5]	X= -1218.70	Y= -831.80	51	TSTP_P	X= 1218.30	Y= 980.20
18	PRT14[4]	X= -698.20	Y= -1173.00	52	SXO	X= 921.80	Y= 1150.60
19	PRT14[3]	X= -582.80	Y= -1173.00	53	SXI	X= 806.20	Y= 1150.60
20	PRT14[2]	X= -467.20	Y= -1173.00	54	VDD	X= 690.8	Y= 1150.60
21	PRT14[1]	X= -351.80	Y= -1173.00	55	MUTE	X= 575.2	Y= 1150.60
22	PRT14[0]	X= -236.20	Y= -1173.00	56	DTMFO	X= 459.8	Y= 1150.60
23	SEG[15]	X= -120.80	Y= -1173.00	57	SDO	X= 344.2	Y= 1150.60
24	SEG[14]	X= -5.20	Y= -1173.00	58	KEYTONE	X= 228.8	Y= 1150.60
25	SEG[13]	X= 110.20	Y= -1173.00	59	PRTD[7]	X= 113.2	Y= 1150.60
26	SEG[12]	X= 225.80	Y= -1173.00	60	PRTD[6]	X= -2.2	Y= 1150.60
27	SEG[11]	X= 341.20	Y= -1173.00	61	PRTD[5]	X= -117.8	Y= 1150.60
28	SEG[10]	X= 456.80	Y= -1173.00	62	PRTD[4]	X= -233.2	Y= 1150.60
29	SEG[9]	X= 572.20	Y= -1173.00	63	PRTD[3]	X= -348.8	Y= 1150.60
30	SEG[8]	X= 687.80	Y= -1173.00	64	PRTD[2]	X= -464.2	Y= 1150.60
31	SEG[7]	X= 803.20	Y= -1173.00	65	PRTD[1]	X= -579.8	Y= 1150.60
32	SEG[6]	X= 918.80	Y= -1173.00	66	PRTD[0]	X= -695.2	Y= 1150.60
33	SEG[5]	X= 1034.20	Y= -1173.00	67	PRTC [7]	X= -810.8	Y= 1150.60
34	SEG[4]	X= 1149.80	Y= -1173.00	68	PRTC [6]	X= -926.2	Y= 1150.60

H. DC/AC Characteristics

Absolute Maximum Rating

Item	Sym.	Rating	Condition
Supply Voltage	V _{dd}	-0.5V ~ 8V	
Input Voltage	V _{in}	-0.5V ~ V _{dd} +0.5V	
Output Voltage	V _o	-0.5V ~ V _{dd} +0.5V	
Operating Temperature	T _{op}	0 ^o C ~ 70 ^o C	
Storage Temperature	T _{st}	-50 ^o C ~ 100 ^o C	

Recommended Operating Conditions

Item	Sym.	Rating	Condition
Supply Voltage	V _{dd}	2.4V ~ 5.5V	
Input Voltage	V _{ih}	0.9 V _{dd} ~ V _{dd}	
	V _{il}	0.0V ~ 0.1V _{dd}	
Operating Frequency	F _{max}	8MHz	V _{dd} =5.0V
		4MHz	V _{dd} =2.4V
Operating Temperature	T _{op}	0 ^o C ~ 70 ^o C	
Storage Temperature	T _{st}	-50 ^o C ~ 100 ^o C	

測試條件:TEMP=25^oC, VDD=3V+/-10%, GND=0V

	PARAMETER		CONDITION	MIN	TYP	MAX	UNIT
I _{Fast}	NORMAL Mode Current	System	2M ext. R/C		0.75	1	mA
I _{Slow}	SLOW Mode Current	System	32.768K X'tal LCD Disable		6	9	μA
I _{Idle}	IDLE Mode Current	System	32.769K X'tal LCD Disable		4	7	μA
I _{LCD}	Extra Current if LCD ON	System	LCD Enable		2	3	μA
I _{Sleep}	Sleep Mode Current	System				1	μA
V _{ih}	Input High Voltage	I/O pins		0.8 V _{DD}			V
V _{il}	Input Low Voltage	I/O pins				0.2 V _{DD}	V
V _{hys}	Input Hysteresis Width	I/O, RSTP_N	Threshold=2/3V _{DD} (input from low to high) Threshold=1/3V _{DD} (input from high to low)		1/3 V _{DD}		V
I _{oH}	Output Drive Current	I/O pull-high ^{*1}	V _{oL} =2.0V	50			μA
I _{oL_1}	Output Sink Current	I/O pull-low ^{*1}	V _{oL} =0.4V	1.0			mA
I _{iL_1}	Input Low Current	RSTP_N	V _{iL} =GND, pull high Internally		20		μA
I _{iL_2}	Input Low Current	I/O	V _{iL} =GND, if pull high Internally by user		100		μA

Note: *1: Drive Current Spec. for Push-Pull I/O port only
 Sink Current Spec. for both Push-Pull and Open-Drain I/O port.

I. Application Circuit

No External Parts is necessary if user adopt Internal Fast RC Clock

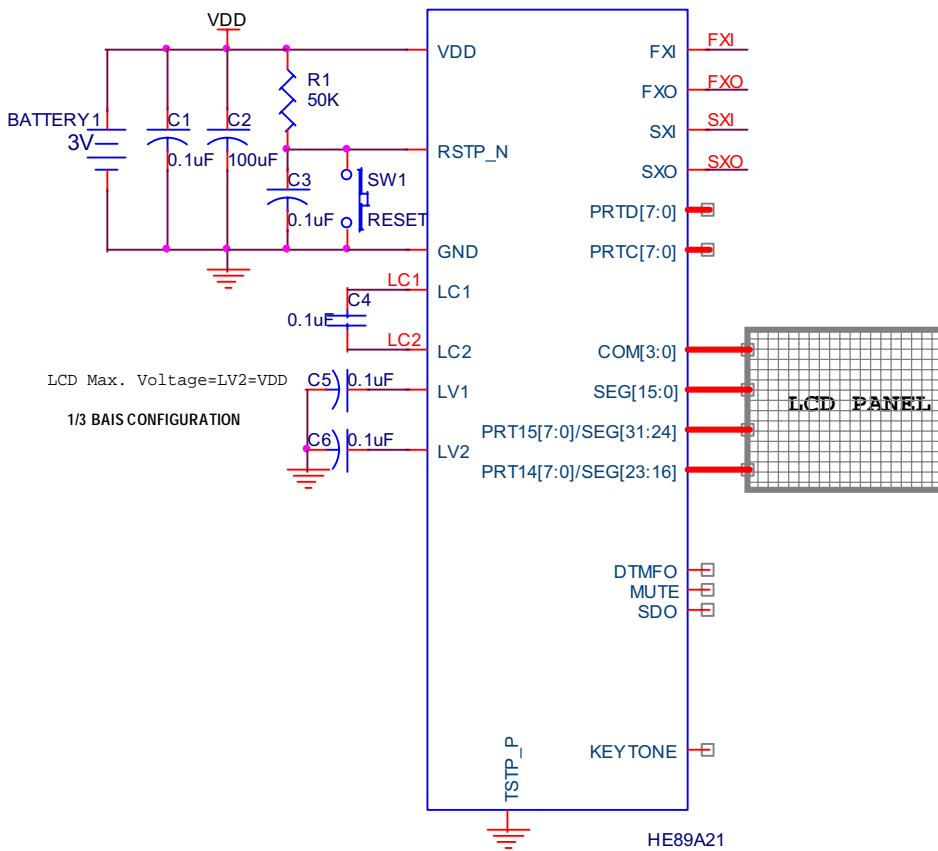

External Fast Clock: Crystal osc.

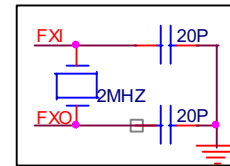

External Fast Clock: RC osc.

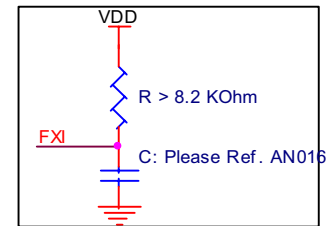

External Slow Clock: Crystal osc.

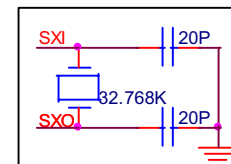

External Slow Clock: RC osc.

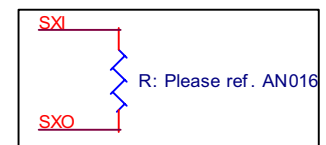

J. Important Note

1. LCD driving circuit must be turn off before IC goes into sleep mode.
2. Please bonds the TSTP_P, RSTP_N and PRTD[7:0] with test point on PCB (can be soldered and probed) as you can, then KB can do some IC testing job on PCB. Neither VDD nor GND connection is necessary for TSTP_P. The following figure is an example (Testing point with through hole).

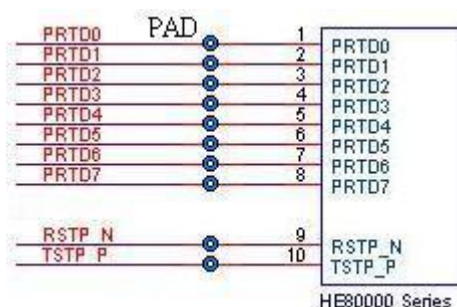

K. Updated Record

Version	Date	Section	Original Content	New Content
V3.1	Dec 24,2001	B, H	2.2V (VDD operation voltage)	2.4V
		C,J		New Section

Компания «Life Electronics» занимается поставками электронных компонентов импортного и отечественного производства от производителей и со складов крупных дистрибьюторов Европы, Америки и Азии.

С конца 2013 года компания активно расширяет линейку поставок компонентов по направлению коаксиальный кабель, кварцевые генераторы и конденсаторы (керамические, пленочные, электролитические), за счёт заключения дистрибьюторских договоров

Мы предлагаем:

- Конкурентоспособные цены и скидки постоянным клиентам.
- Специальные условия для постоянных клиентов.
- Подбор аналогов.
- Поставку компонентов в любых объемах, удовлетворяющих вашим потребностям.
- Приемлемые сроки поставки, возможна ускоренная поставка.
- Доставку товара в любую точку России и стран СНГ.
- Комплексную поставку.
- Работу по проектам и поставку образцов.
- Формирование склада под заказчика.
- Сертификаты соответствия на поставляемую продукцию (по желанию клиента).
- Тестирование поставляемой продукции.
- Поставку компонентов, требующих военную и космическую приемку.
- Входной контроль качества.
- Наличие сертификата ISO.

В составе нашей компании организован Конструкторский отдел, призванный помогать разработчикам, и инженерам.

Конструкторский отдел помогает осуществить:

- Регистрацию проекта у производителя компонентов.
- Техническую поддержку проекта.
- Защиту от снятия компонента с производства.
- Оценку стоимости проекта по компонентам.
- Изготовление тестовой платы монтаж и пусконаладочные работы.



Тел: +7 (812) 336 43 04 (многоканальный)
Email: org@lifeelectronics.ru